

Safety Card S1



Safety Card - Servo Amplifier

This document is a translation of the original document.

All rights to this documentation are reserved by Pilz GmbH & Co. KG. Copies may be made for internal purposes.

Suggestions and comments for improving this documentation will be gratefully received.

Pilz[®], PIT[®], PMI[®], PNOZ[®], Primo[®], PSEN[®], PSS[®], PVIS[®], SafetyBUS p[®], SafetyEYE[®], SafetyNET p[®], the spirit of safety[®] are registered and protected trademarks of Pilz GmbH & Co. KG in some countries.



SD means Secure Digital.

Contents		Page
Chapter 1 Introduction		
1.1	Validity of documentation	1-1
1.1.1	Retaining the documentation	1-1
1.2	Overview of documentation	1-2
1.3	Definition of symbols	1-3
Chapter 2 Overview		
2.1	Unit structure	2-1
2.1.1	Unit features	2-1
2.2	Front view	2-3
Chapter 3 Safety		
3.1	Intended use	3-1
3.1.1	Permitted motor types	3-2
3.1.2	Permitted motor encoder types	3-2
3.1.3	Use of qualified personnel	3-3
3.1.4	Warranty and liability	3-3
3.1.5	Disposal	3-3
3.2	Standards	3-4
Chapter 4 Function Description		
4.1	Overview	4-1
4.2	Inputs and outputs	4-3
4.2.1	Inputs	4-3
4.2.2	Outputs	4-3
4.2.2.1	Single-pole outputs	4-3
4.2.2.2	Dual-pole outputs	4-5
4.2.2.3	Output test	4-6
4.3	Safety functions	4-8
4.3.1	Safe torque off - STO	4-9
4.3.2	Safe stop 1 - SS1	4-10
4.3.3	Safe stop 2 - SS2	4-14
4.3.4	Safe operating stop - SOS	4-17
4.3.5	Safely limited speed - SLS	4-19
4.3.6	Safe speed range - SSR	4-22
4.3.7	Safe direction - SDI	4-25
4.3.8	Safe brake control - SBC	4-29
4.3.9	Safe brake test - SBT	4-30
4.4	Operating mode of the servo amplifier	4-34
4.5	Reaction times	4-36
4.6	Configuration	4-37

Chapter 5 Installation		
5.1	General requirements	5-1
5.2	Dimensions	5-2
5.3	Installing the safety card	5-3
Chapter 6 Wiring		
6.1	General wiring guidelines	6-1
6.2	Connector pin assignment	6-2
6.3	Shielding	6-3
6.4	Digital inputs	6-4
6.5	Digital outputs	6-5
6.5.1	Supply voltage	6-5
6.5.2	Single-pole outputs	6-6
6.5.3	Dual-pole outputs	6-8
6.6	Encoder	6-9
6.6.1	Supply voltage	6-9
6.6.2	Incremental encoder with TTL signal	6-10
Chapter 7 Commissioning		
7.1	Safety guidelines	7-1
7.2	Initial commissioning	7-2
7.3	Recommissioning	7-5
7.3.1	Recommissioning at a restart	7-5
7.3.2	Recommissioning after error	7-6
7.3.2.1	Switching the inputs "SS1 Activate" or "SS1 SIL3/Reset"	7-6
7.3.2.2	Command "CLRFAULT"	7-7
7.3.3	Swap safety card	7-8
7.3.3.1	Download configuration from Configurator to safety card	7-10
7.3.3.2	Download configuration to SD card	7-10
7.3.3.3	Download configuration from SD card to safety card	7-11
7.4	Safety checks	7-13
Chapter 8 Operation		
8.1	Operating states	8-2
8.2	Testing the safe pulse disabler	8-4
8.3	Display elements	8-5
8.4	Messages	8-6
Chapter 9 Technical Details		
9.1	Technical Details	9-1
9.2	Safety characteristic data	9-3
9.2.1	Safe actuator with one encoder	9-3

9.2.1.1	MTTF \geq 10 years	9-3
9.2.1.2	MTTF \geq 57 years	9-3
9.2.2	Safe actuator with two encoders	9-4

Chapter 10	Glossary
-----------------------	-----------------

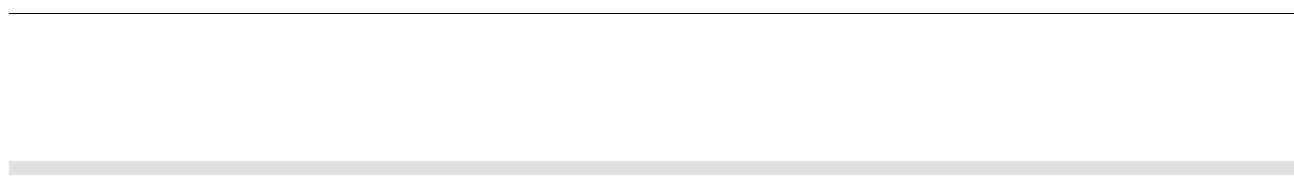

1.1 Validity of documentation

This documentation is valid for the product **Safety Card S1**. It is valid until new documentation is published.

This instruction manual explains the function and operation, describes the installation and provides guidelines on how to connect the product **Safety Card S1**.

Please also refer to the following documents from the motion control range:

- ▶ The configuration of the expansion card is described in the online help for the Configurator SafetyGUI.
- ▶ The servo amplifier S700 is described in the "S700 Instruction Manual".
- ▶ Details of how to set the parameters for the servo amplifier are described in the online help for the commissioning software DriveGUI.

All the manuals can be found on the supplied CD-ROM.

You will need to be conversant with the information in these documents in order to fully understand this manual.

1.1.1 Retaining the documentation

This documentation is intended for instruction and should be retained for future reference.

1.2 Overview of documentation

1 Introduction

The introduction is designed to familiarise you with the contents, structure and specific order of this manual.

2 Overview

This chapter provides information on the product's most important features.

3 Safety

This chapter must be read as it contains important information on safety and intended use.

4 Function Description

This chapter describes the product's individual functions.

5 Installation

This chapter explains how to install the product.

6 Wiring

This chapter describes the product's wiring.

7 Commissioning

This chapter describes how to commission the product.

8 Operation

This chapter describes the display elements, explaining their operation and diagnostics.

9 Technical Details

10 Glossary

1.3 Definition of symbols

Information that is particularly important is identified as follows:



DANGER!

This warning must be heeded! It warns of a hazardous situation that poses an immediate threat of serious injury and death and indicates preventive measures that can be taken.



WARNING!

This warning must be heeded! It warns of a hazardous situation that could lead to serious injury and death and indicates preventive measures that can be taken.



CAUTION!

This refers to a hazard that can lead to a less serious or minor injury plus material damage, and also provides information on preventive measures that can be taken.



NOTICE

This describes a situation in which the unit(s) could be damaged and also provides information on preventive measures that can be taken. It also highlights areas within the text that are of particular importance.



INFORMATION

This gives advice on applications and provides information on special features.

1 Introduction

2.1 Unit structure

The **Safety Card S1** is an expansion of the servo amplifier S700. It is used for safe motion monitoring, which is achieved in conjunction with the standard motor encoder and servo amplifier. In the event of an error, the servo amplifier's power element shuts down the power quickly and safely.

2.1.1 Unit features

The safety card has the following features:

9 single-pole, digital inputs to activate the safety functions in accordance with EN 61800-5-2:

- ▶ Safe stop 1 (SS1)
- ▶ Safe stop 2 (SS2)
- ▶ Safe operating stop (SOS)
- ▶ Safe speed range (SSR)
- ▶ Safely limited speed (SLS)
- ▶ Safe direction (SDI)
- ▶ Safe brake test (SBT) (not defined in EN 61800-5-2)
- ▶ Additional safe input to achieve SIL3 and reset the safety card after an error

1 input for incremental encoder

7 single-pole, digital outputs for the status of the safety functions plus the operating status:

- ▶ Safe torque off (STO)
- ▶ Safe operating stop (SOS)
- ▶ Safe range (SRA)
- ▶ Safe direction (SDI)
- ▶ Safety card ready
- ▶ Safe brake test (SBT)
- ▶ Second shutdown route (STO SIL3)

1 dual-pole digital output for

- ▶ Safe brake control (SBC)

Supply voltage

- ▶ 24 VDC for digital outputs

LEDs for

- ▶ Supply voltage (POWER)
- ▶ System status (RUN)

2 Overview

2.1 Unit structure

- ▶ Download of configuration data (CONFIG)
- ▶ Fault (FAULT)

2.2 Front view

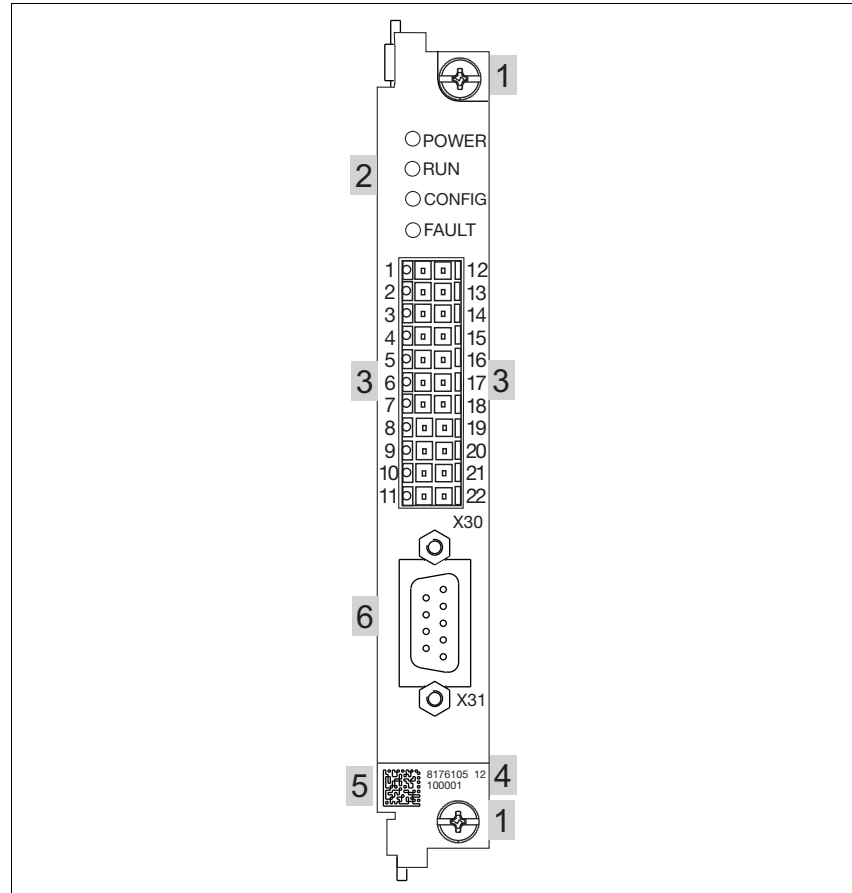

Key:

- ▶ 1: Screw for attachment to the servo amplifier
- ▶ 2: LEDs to display operating states
- ▶ 3: Inputs/outputs and supply voltage
- ▶ 4: Labelling strip with:
 - Order number
 - Serial number
 - Number of device version
- ▶ 5: 2D code
- ▶ 6: Connection for encoder

3.1 Intended use

The **Safety Card S1** is an expansion of the servo amplifier S700. It is designed for use in safety-related applications.

It meets the requirements for safety functions in accordance with EN 61800-5-2, with regard to safe motion monitoring.

The safety card meets the requirements of EN IEC 61508 up to SIL 3 and EN ISO 13849-1 up to PL e.

To achieve category SIL 3 or PL e, the operator must ensure that the function of the safe pulse disabler is tested periodically, after 8 hours at the latest, by triggering safety functions SS1 or STO:

- ▶ By restarting after safety functions SS1 or STO have been triggered as a condition of operation
or
- ▶ By restarting after safety function SS1 has been triggered by the operator



INFORMATION

To test the safe pulse disabler through deliberate operator action, see the section entitled "Operation", under "Testing the safe pulse disabler".

The following is deemed improper use:

- ▶ Any component, technical or electrical modification to the servo amplifier
- ▶ Use of the servo amplifier outside the areas described in this manual
- ▶ Use of the servo amplifier outside the documented technical details (see chapter entitled "Technical Details")

Intended use includes making the installation and wiring EMC-compliant.

Intended use also includes compliance with the

- ▶ S700 Instruction Manual
- ▶ Online help for the configuration tool SafetyGUI

The safety card **Safety Card S1** from Version 1.0 may only be used in conjunction with the following servo amplifiers:

- ▶ S701 from Version 2.10
- ▶ S703 from Version 2.10
- ▶ S706 from Version 2.10

3.1 Intended use

- ▶ S712 from Version 2.10
- ▶ S724 from Version 2.10
- ▶ S748 from Version 2.10
- ▶ S772 from Version 2.10

3.1.1 Permitted motor types

The following motor types are approved for use with the safety card:

- ▶ Rotary synchronous motors
- ▶ Linear synchronous motors

Please note: The use of synchronous motors without motor encoder (sensorless operation) is not permitted.

Work is in progress for use with:

- ▶ Asynchronous motors

3.1.2 Permitted motor encoder types

The following motor encoder types are approved for use with the safety card:

Encoder type	Feedback type (parameter FBTYPE) in the servo amplifier's commissioning software	Status for operation with safety card
Resolver	0	Enabled
SinCos encoder with Hiperface interface	2	Enabled
SinCos encoder with EnDat 2.1 interface (analogue)	4	Enabled
SinCos encoder 5V with wake & shake	7	Enabled
SinCos encoder with BiSS interface 5V (digital)	20	Enabled
SinCos encoder with BiSS interface 12V (digital)	22	Enabled
SinCos encoder with EnDat 2.2 interface 5V (digital)	32	Enabled
SinCos encoder with EnDat 2.2 interface 12V (digital)	34	Enabled

3.1 Intended use

3.1.3 Use of qualified personnel

The products may only be assembled, installed, programmed, commissioned, operated, maintained and decommissioned by competent persons.

A competent person is someone who, because of their training, experience and current professional activity, has the specialist knowledge required to test, assess and operate the work equipment, devices, systems, plant and machinery in accordance with the general standards and guidelines for safety technology.

It is the company's responsibility only to employ personnel who:

- ▶ Are familiar with the basic regulations concerning health and safety / accident prevention
- ▶ Have read and understood the safety guidelines given in this description
- ▶ Have a good knowledge of the generic and specialist standards applicable to the specific application.

3.1.4 Warranty and liability

All claims to warranty and liability will be rendered invalid if:

- ▶ The product was used contrary to the purpose for which it is intended
- ▶ Damage can be attributed to not having followed the guidelines in the manual
- ▶ Operating personnel are not suitably qualified
- ▶ Any type of modification has been made (e.g. exchanging components on the PCB boards, soldering work etc.).

3.1.5 Disposal

- ▶ In safety-related applications, please comply with the mission time t_M in the safety-related characteristic data.
- ▶ When decommissioning, please comply with local regulations regarding the disposal of electronic devices (e.g. Electrical and Electronic Equipment Act).

3.2 Standards

Knowledge of and compliance with the relevant standards and directives are a prerequisite for using the safety card. The following standards are relevant:

- ▶ EN 61326-3-1:2008: Electrical equipment for measurement, control and laboratory use - EMC requirements
- ▶ EN 61800-3:2004: Adjustable speed electrical drives
- ▶ EN 61800-5-2:2007: Adjustable speed electrical power drive systems – Part 5-2: Safety requirements. Functional
- ▶ EN ISO 13849-1:2008: Safety of machinery – Safety-related parts of control systems – Part 1: General principles for design, Part 2: Validation
- ▶ EN 61508:1998: Functional safety of safety-related electrical/electronic/programmable electronic control systems, Parts 1, 3, 4
- ▶ EN 61508-2:2000: Requirements for safety-related electrical/electronic/programmable electronic systems
- ▶ EN 60204-1:2007: Safety of machinery – Electrical equipment of machines – Part 1: General requirements
- ▶ EN 62061:2005: Safety of machinery – Functional safety of safety-related electrical, electronic and programmable electronic control systems

Please note this is not an exhaustive list of safety standards and directives.

4.1 Overview

The safety card monitors safety functions in accordance with EN 61800-5-2. It monitors safe motion sequences on drives, which are safely brought to a stop and shut down in the event of an error.

The safety card is built into a servo amplifier S700. This converts the servo amplifier into a safe servo amplifier.

A safe drive system consists of the following:

- ▶ Servo amplifier (S700)
- ▶ Safety card built into the servo amplifier
- ▶ Servo motor (synchronous motor) with
 - Standard encoder system (feedback)
 - Brake (optional, not safety-related)
- ▶ Safety control system

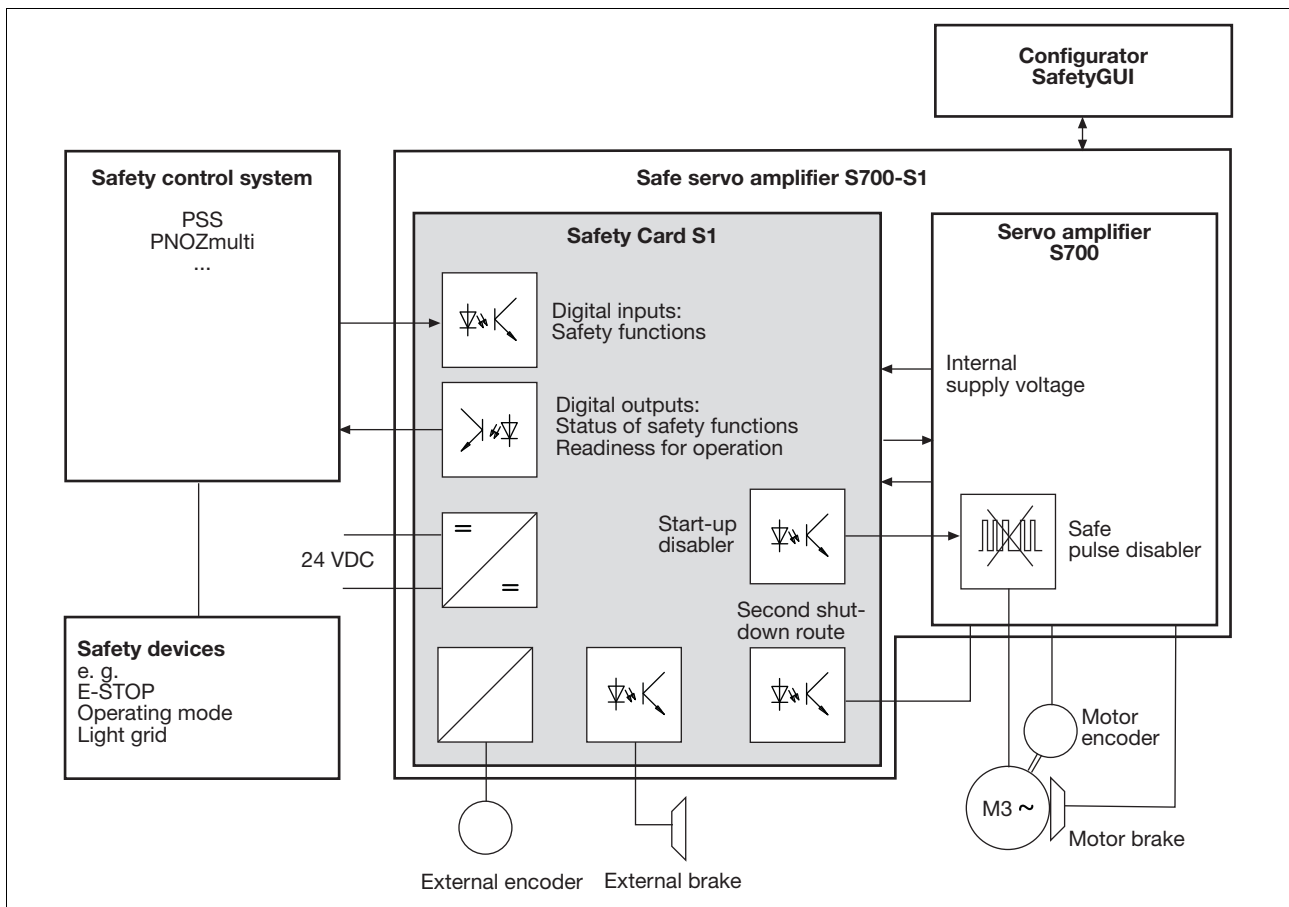

Fig. 4-1: Safe drive system

4.1 Overview

The **safety card**

- ▶ Activates safety functions
- ▶ Monitors safe motion sequences
- ▶ Signals the status of safety functions to the safety control system
- ▶ In the event of an error, activates the safe pulse disabler which is integrated within the servo amplifier and shuts down the power to the motor
- ▶ Passes the brake command to the servo amplifier that is executing the travel command.
- ▶ Has a second shutdown route in order to implement categories SIL3 or PL e.
- ▶ Has a dual-pole output to control an external holding brake. The brake can be tested using the safety function "safe brake test SBT".
- ▶ Has a connection for an external encoder (incremental encoder or encoder with SSI signals can be selected). For details of the safety-related assessment when using an external encoder see Chapter 8 "Technical Details", under "Safety-related characteristic data".

The **servo amplifier**

- ▶ Removes the power to the motor, if the safe pulse disabler is activated, switches the motor to torque-free and can also control an internal motor brake.

The **safety control system**

- ▶ Activates the safety functions via inputs on the safety card
- ▶ Evaluates signals from safety devices, such as:
 - E-STOP pushbuttons
 - Safety gates
 - Light beam devices
 - Two-hand buttons
- ▶ Processes the safety card's status outputs
- ▶ Safe interconnection between safety card and safety control system
- ▶ Fault detection (shorts across contacts, short circuits) on signals between the safety control system and safety card, and initiation of measures

Configurator SafetyGUI

- ▶ Configuration and parameterisation of the safety card
- ▶ Safe upload and download of the configuration file
- ▶ Online display of the status of the safety functions
- ▶ Display of error stack
- ▶ Ability to save the configuration to SD card

4.2 Inputs and outputs

4.2.1 Inputs

The single-pole digital inputs are used to activate the safety functions.

- ▶ **SS1 Activate:** Safe stop 1
- ▶ **SS2 Activate:** Safe stop 2
- ▶ **SOS Activate:** Safe operational stop
- ▶ **SSR Activate:** Safe speed range
- ▶ **SLS Activate:** Safely limited speed
- ▶ **SDI Neg Activate:** Safe anti-clockwise direction
- ▶ **SDI Pos Activate:** Safe clockwise direction
- ▶ **SBT Activate:** Safe brake test
- ▶ **SS1 SIL3/Reset:** Additional safe input to achieve SIL3 and reset the safety card after an error

Signals at the input

- ▶ 1/0 pulse edge at the input: Safety function is activated
- ▶ "0" signal (0 V) at the input:
 - Safety function is activated
- ▶ "1" signal (+24 V) at the input:
 - Safety function is not activated



NOTICE

Inputs "SS1 Activate" and "SS1 SIL3/Reset" must always be connected.

In the case of all inputs, only tested outputs from a safety control system may be connected.

4.2.2 Outputs

4.2.2.1 Single-pole outputs

Safe, single-pole outputs signal the status of the activated safety functions and the safety card's state of readiness.

- ▶ **STO Acknowledge**
 - 1: Power element switched off
 - Internal error on servo amplifier or safety card
 - Limit values exceeded
 - Activated via SS1
 - 0: Drive in closed loop operation

4.2 Inputs and outputs

- ▶ **SOS Acknowledge**
 - 1: Motor is within the permitted limit values for standstill.
 - 0: Standstill monitoring is inactive or motor is outside the standstill range
- ▶ **SDI Acknowledge**
 - 1: Drive is moving in the permitted direction.
 - 0: Drive is not moving in the permitted direction or monitoring is not activated.
- ▶ **SRA Acknowledge**
 - 1: Drive is moving within the permitted limit values for speed.
 - 0: Drive is moving outside the permitted limit values for speed or monitoring is not activated.
- ▶ **Ready**
 - 1: Safety card is ready for operation
 - 0: Safety card is not ready for operation (e.g. run-up, no supply voltage or major internal error)
- ▶ **SBT Acknowledge**
 - 1: Brake test was run within the defined period
 - 0: Brake test must be activated within a selectable time period, otherwise the axis is shut down.
- ▶ **STO SIL3**
 - 1: Second shutdown route on
 - 0: Second shutdown route off



INFORMATION

If the "STO SIL3" output is not used, 24 VDC must be applied to the "STO2-ENABLE" input on the servo amplifier.

The table below shows which outputs signal the status of which safety function.

Output	Internal error	No safety function activated	SS1	SS2	SOS	SLS	SSR	SDI	SBT
STO Acknowledge	x	x	x	x	x	x	x	x	x
SOS Acknowledge	-	-	-	x	x	-	-	-	x
SDI Acknowledge	-	-	-	-	-	-	-	x	-
SRA Acknowledge	-	-	-	-	-	x	x	-	-
SBT Acknowledge	-	-	-	-	-	-	-	-	x
Ready	-	x	x	x	x	x	x	x	x

4.2 Inputs and outputs

Signals at the output

- ▶ “0” signal (0 V) at the output:
 - Output is high impedance
 - No current to the load
 - Safety function not activated
- ▶ “1” signal (+24 V) at the output:
 - Output is low impedance
 - Current is supplied to the load
 - Safety function activated

Supply voltage

- ▶ 24 VDC connection to supply the safety card's digital outputs

4.2.2.2 Dual-pole outputs

The safety card has a dual-pole output to control an external mechanical brake:

▶ **SBC+/SBC-**

Signals at the output

- ▶ “0” signal (0 V) at the output (SBC+/SBC-):
 - Output is high impedance
 - No current to the load
 - Safety function is activated, brake closed
- ▶ “1” signal (+24 V) at the output (SBC+/SBC-):
 - Output is low impedance
 - Current is supplied to the load
 - Safety function is not activated, brake open



NOTICE

Only a brake which operates in accordance with the failsafe principle may be connected.

Supply voltage

- ▶ 24 VDC connection to supply the safety card's digital outputs

4.2 Inputs and outputs

4.2.2.3 Output test

The outputs are tested regularly:

- ▶ Outputs that are switched on are checked via regular off tests.
 - Test pulses for outputs that are switched on: see technical details
 - Outputs that are switched on are switched off for the duration of the test pulse.
 - The load must not switch off because of the test.
- ▶ Outputs that are switched off are checked via regular on tests.
 - Test pulses for outputs that are switched off: see technical details
 - Outputs that are switched off are switched on for the duration of the test pulse.
 - The load must not switch on because of the test.

Testing for shorts

- ▶ A test is regularly carried out to check for shorts between the outputs.



WARNING!

When wiring an output with capacitance it is essential to note the pulse duration, repetition period and scan time of the power-up test, otherwise the load may switch on unintentionally.

Timing diagram

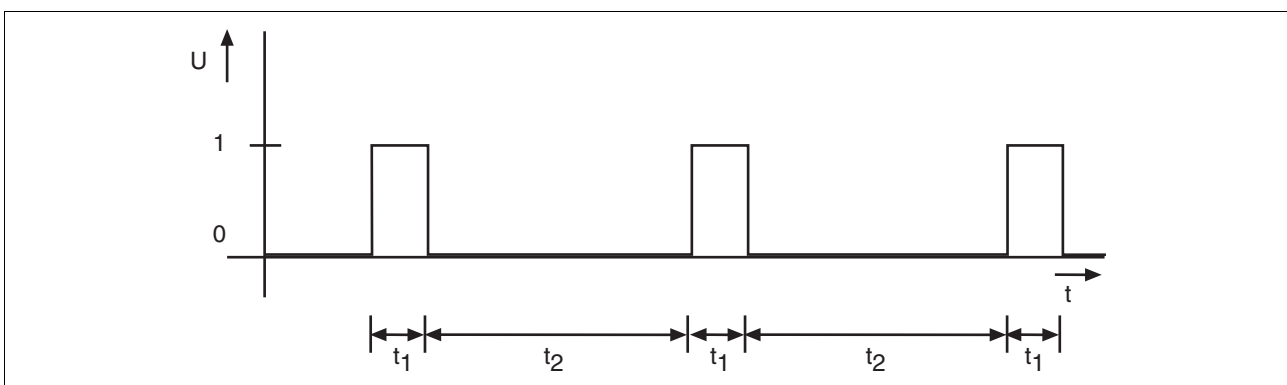

- ▶ 1: "1" Signal
- ▶ 0: "0" Signal
- ▶ t_1 Pulse duration on power-up test (see Technical details)
- ▶ t_2 Scan time of power-up test under normal circumstances (ca. 200 ms)

4.2 Inputs and outputs

Characteristic: Output capacitance C dependent on load current I

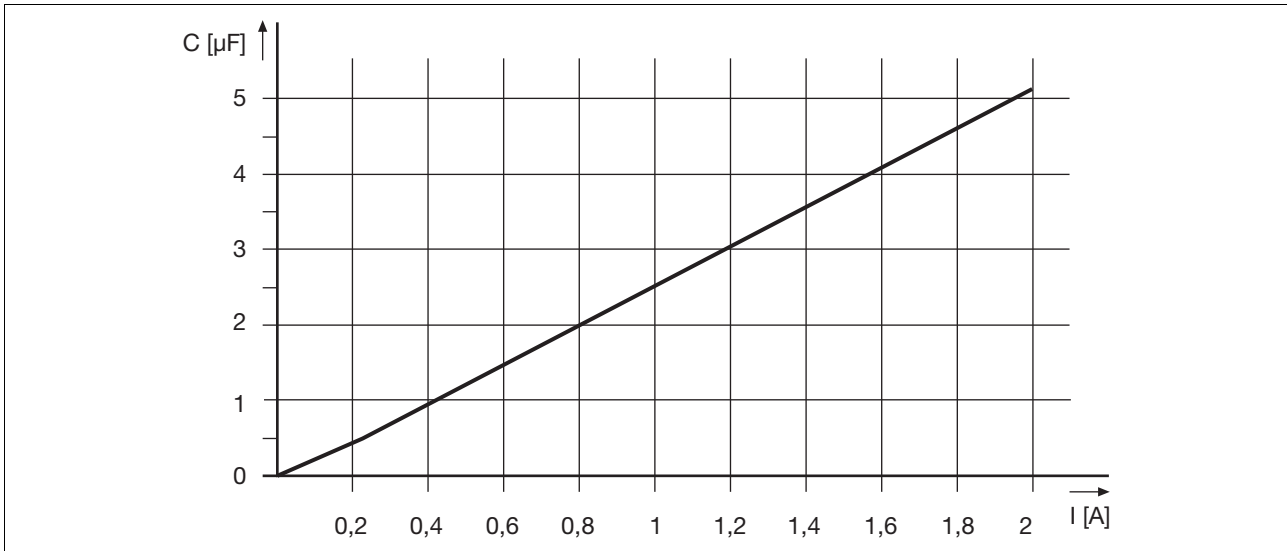

4.3 Safety functions

Safety functions maintain a safe condition on a plant or prevent hazardous conditions arising on a plant.

The safety functions for electrical drives are defined in EN 61800-5-2.

The safety card implements the following safety functions:

- ▶ Safe stop 1 (SS1)
- ▶ Safe stop 2 (SS2)
- ▶ Safe operating stop (SOS)
- ▶ Safe speed range (SSR)
- ▶ Safely limited speed (SLS)
- ▶ Safe direction (SDI)
- ▶ Safe brake control (SBC)
- ▶ Safe brake test (SBT) (not defined in EN 61800-5-2)

Activation of safety functions

- ▶ The safety functions are activated using the single-pole safe inputs on the safety card.
- ▶ These inputs operate in accordance with the failsafe principle (on switching off). The safety control system activates the safety functions via a 1/0 pulse edge.

Feedback from the safety functions

- ▶ Message via single-pole semiconductor outputs
 - “1” Signal: Inside the set limit values
 - “0” Signal: Outside the set limit values

Simultaneous activation of safety functions

- ▶ All safety functions can be active at the same time. However, safety function SS1 has priority over all other safety functions.
- ▶ If SS1 is activated, the drive is stopped in accordance with its configuration.
- ▶ During this time, no other safety functions may be processed or called up.

Reaction to limit value violations and errors

- ▶ When set limit values are exceeded, the E-STOP braking ramp is activated.
- ▶ The safety function STO is activated if there are any internal errors on the safety card or servo amplifier. The power element is switched off.

4.3 Safety functions

4.3.1 Safe torque off - STO

The safety function "safe torque off" (STO) removes the power to the motor. It is implemented via the servo amplifier's shutdown path and the safety card's safe outputs.

Features of the safety function:

- ▶ The motor becomes torque-free and no longer generates any hazardous movements.
- ▶ To prevent the drive running down in an uncontrolled manner, in normal operation the safety function STO is activated via the safety function SS1.
- ▶ STO is only activated directly when
 - there is an internal error on the servo amplifier or safety card
 - the STO delay time is set to 0
- ▶ The STO-ENABLE reset lock on the servo amplifier has no function if the servo amplifier contains a safety card. The output contact is linked internally. In this case, the safety card activates the safe pulse disable on the servo amplifier in order to shut down the power element.
- ▶ The safety function "safe torque off" corresponds to a category 0 stop (uncontrolled stop) in accordance with EN 60204-1.

Prerequisites for normal operation:

- ▶ Input "SS1 Activate" and "SS1 SIL3/Reset": "1" Signal (+24 VDC)
- ▶ "Ready" output: "1" Signal (+24 VDC). The safety card is ready for operation.
- ▶ "STO Acknowledge" output: "0" Signal
- ▶ To achieve SIL3 or Plc: Connect the output "STO SIL3" to servo amplifier terminal X4A/ 3.

Safety function is activated

- ▶ By an error after limit values have been exceeded or
- ▶ By an internal error on the safety card or servo amplifier, if the drive can no longer be braked safely
- ▶ By executing the safety function SS1 (1/0 pulse edge). In this case the drive is braked safely before it is switched to torque-free (see section: "Safe stop – SS1").

Reaction:

- ▶ The drive is switched to torque-free
- ▶ "STO Acknowledge" output: "1" Signal

If any external forces influence the motor axis (e.g. suspended loads), additional measures (e.g. a safety holding brake) are required in order to eliminate hazards.

4.3 Safety functions

Timing diagram

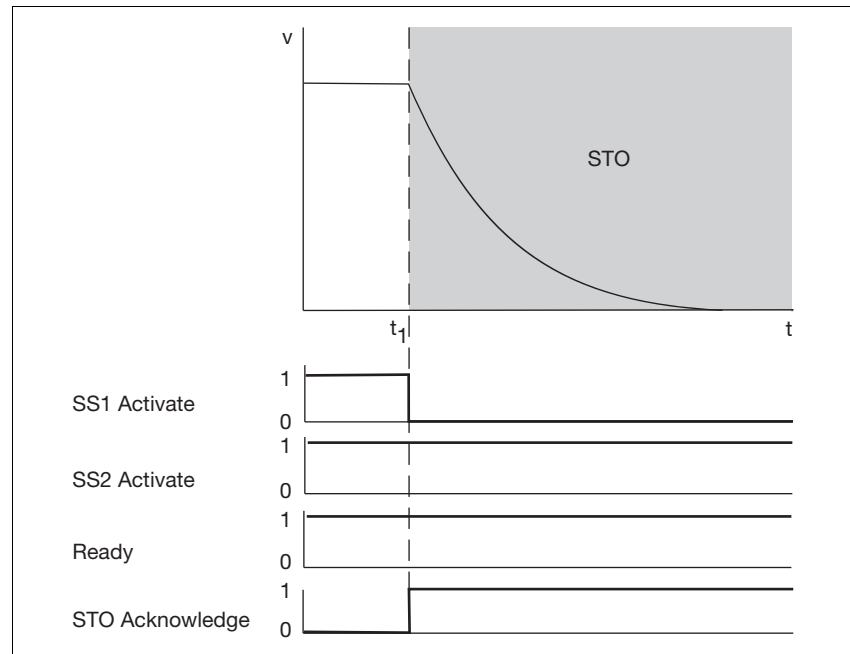

Fig. 4-2: Safety function STO

- ▶ t_1 : Activation of the safety function STO
- ▶ SS1 Activate: Input for safety function SS1
- ▶ SS2 Activate: Input for safety function SS2
- ▶ Ready: Output for operating status of the safety card
- ▶ STO Acknowledge: Output for feedback from the safety function STO

4.3.2 Safe stop 1 - SS1

The safety function "safe stop 1" (SS1) brakes the motor to standstill in a controlled manner and removes the power to the motor. After a defined period (STO delay time) or once the motor is at standstill, the safety function "safe torque off" (STO) removes the power to the motor.

Features of the safety function:

- ▶ The motor becomes torque-free and no longer generates any hazardous movements.
- ▶ The safety function "safe stop 1" corresponds to a category 1 stop (controlled braking) in accordance with EN 60204-1.

4.3 Safety functions

The safety card monitors the following functions:

- ▶ Braking ramp
 - In the Configurator, the braking ramp is specified and monitoring is activated. The braking period depends on the speed of the motor when braking is started.
 - The braking ramp can be monitored via a maximum position error specified in the Configurator.
- ▶ Braking ramp in normal operation
 - The drive starts with the configured braking ramp when safety function SS1 has been activated. Once the time has elapsed, STO is activated.
- ▶ E-STOP braking ramp:
 - The drive starts with the configured braking ramp when
 - there is an internal error
 - limit values are exceeded
- ▶ Safety function STO is activated when
 - the actual braking period is longer than the configured STO delay time.
 - the configured limit value for the position error is exceeded.
- ▶ Automatic STO at standstill
 - A standstill threshold for activating the safety function STO can be specified in the Configurator.
 - Safety function STO is activated when
 - standstill is achieved while the STO delay time is running.
 - the STO delay time has elapsed.

Prerequisites for normal operation:

- ▶ Input "SS1 Activate" and "SS1 SIL3/Reset": "1" Signal (+24 VDC)
- ▶ "Ready" output: "1" Signal (+24 VDC). The safety card is ready for operation.
- ▶ "STO Acknowledge" output: "0" Signal
- ▶ To achieve SIL3 or Ple: Connect the output "STO SIL3" to servo amplifier terminal X4A/ 3.

Safety function is activated

- ▶ By a 1/0 pulse edge at the input "SS1 Activate" and/or
- ▶ By a 1/0 pulse edge at the input "SS1 SIL3/Reset"
- ▶ Internal error

Signal status of the inputs "SS1 Activate" and "SS1 SIL3/Reset"

- ▶ The STO delay time starts when one of the two inputs "SS1 Activate" or "SS1 SIL3/Reset" is set to "0". The safety function "STO" is activated once the STO delay time has elapsed.

4.3 Safety functions

- ▶ The safety function "STO" is activated before the STO delay time has elapsed if the second input is also set to "0".
- ▶ The safety function "STO" is always activated when both the inputs "SS1 Activate" and "SS1 SIL3/Reset" are set to "0".
- ▶ The method by which the servo amplifier receives the command for controlled braking of the motor is defined in the Configurator:
 - **Drive-activated:** After the safety function is triggered, the safety card issues a command to the servo amplifier for controlled braking of the motor. The braking ramp is configured in the Configurator.
 - **Controller-activated:** After the safety function is triggered, the control system issues a command to the servo amplifier for controlled braking of the motor. The braking ramp must only be configured in the Configurator if monitoring of the braking ramp is also activate there.

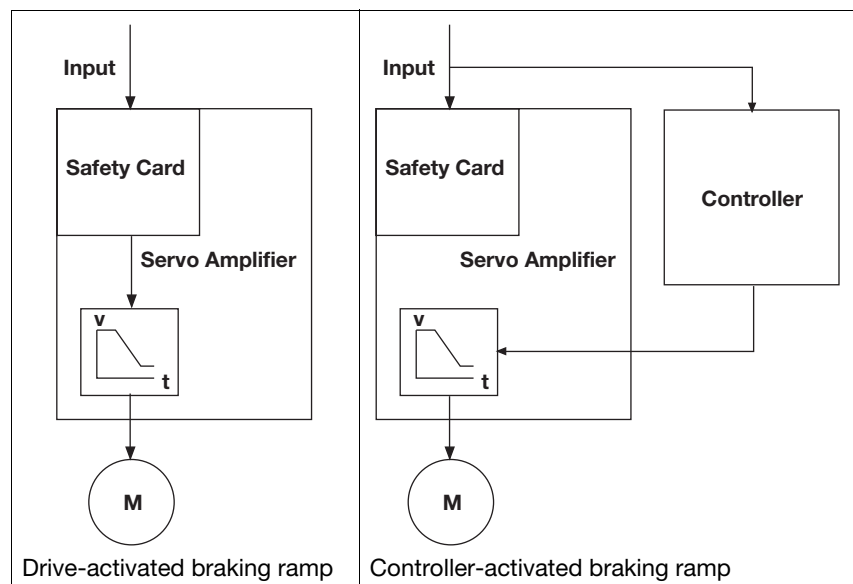

Reaction

- ▶ Controlled braking of the drive, with the configured braking ramp.
- ▶ When the STO delay time has elapsed, the safety card activates the safety function "safe torque off" (STO). The motor becomes torque-free.
- ▶ "STO Acknowledge" output: "1" Signal

If any external forces influence the motor axis (e.g. suspended loads), additional measures (e.g. a safety holding brake) are required in order to eliminate hazards.

4.3 Safety functions

Timing diagram: STO is started once the STO delay time has elapsed

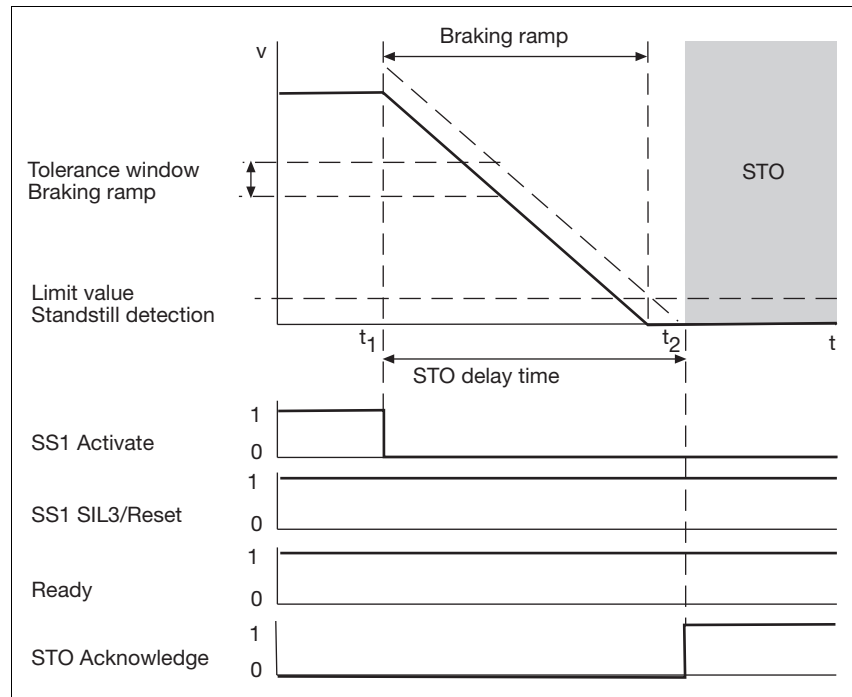

Timing diagram: STO is started during the STO delay time

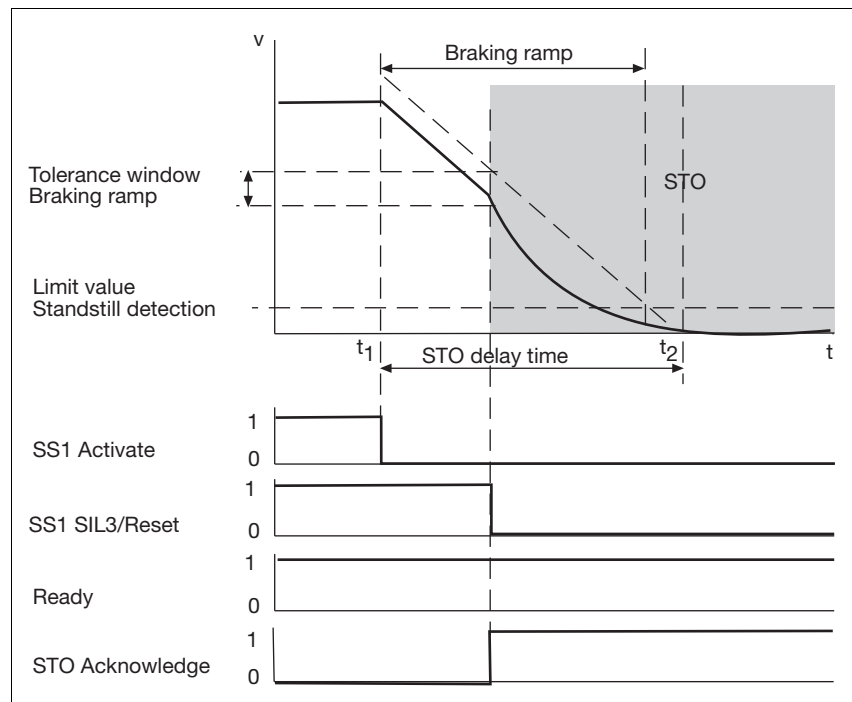

Fig. 4-3: Safety function SS1

4.3 Safety functions

- ▶ t_1 : Activation of safety function SS1
- ▶ t_2 : Activation of safety function STO
- ▶ SS1 Activate: Input for safety function SS1
- ▶ SS1 SIL3/Reset: Input for SIL3 and reset
- ▶ Ready: Output for operating status of the safety card
- ▶ STO Acknowledge: Output for feedback from safety function STO

4.3.3 Safe stop 2 - SS2

The safety function "Safe Stop 2" (SS2) brakes the drive in a controlled manner and monitors it for standstill.

Features of the safety function:

- ▶ The drive's control functions are maintained. Power is applied to the motor.
- ▶ Power to the motor is not shut down.
- ▶ The safety function "Safe Stop 2" corresponds to controlled braking in accordance with IEC 60204-1, stop category 2.

The safety card monitors the following functions:

- ▶ Braking ramp
 - In the Configurator, the braking ramp is specified and monitoring is activated. The braking period depends on the speed of the motor when braking is started.
 - The braking ramp can be monitored via a maximum position error specified in the Configurator.
- ▶ Braking ramp in normal operation
 - The drive starts with the configured braking ramp when safety function SS2 has been activated. Once the time has elapsed, SOS is activated.
- ▶ Standstill position
 - The safety function monitors whether the standstill position remains within a configured tolerance window.
 - Safety function SS1 (E-STOP braking ramp) is activated if the standstill position leaves the tolerance window.
- ▶ Automatic SOS at standstill
 - A standstill threshold for activating the safety function SOS can be specified in the Configurator.
 - Safety function SOS is activated when
 - standstill is achieved while the SOS delay time is running.
 - the SOS delay time has elapsed.

4.3 Safety functions

Prerequisites for normal operation:

- ▶ Input "SS1 Activate" and "SS1 SIL3/Reset": "1" Signal (+24 VDC)
- ▶ "Ready" output: "1" Signal (+24 VDC). The safety card is ready for operation.
- ▶ "STO Acknowledge" output: "0" Signal
- ▶ To achieve SIL3 or Ple: Connect the output "STO SIL3" to servo amplifier terminal X4A/ 3.

Safety function is activated

- ▶ By a 1/0 pulse edge at the input "SS2 Activate".
- ▶ The method by which the servo amplifier receives the command for controlled braking of the motor is defined in the Configurator:
 - **Drive-activated:** After the safety function is triggered, the safety card issues a command to the servo amplifier for controlled braking of the motor. The braking ramp is configured in the Configurator.
 - **Controller-activated:** After the safety function is triggered, the control system issues a command to the servo amplifier for controlled braking of the motor. The braking ramp must only be configured in the Configurator if monitoring of the braking ramp is also activate there.

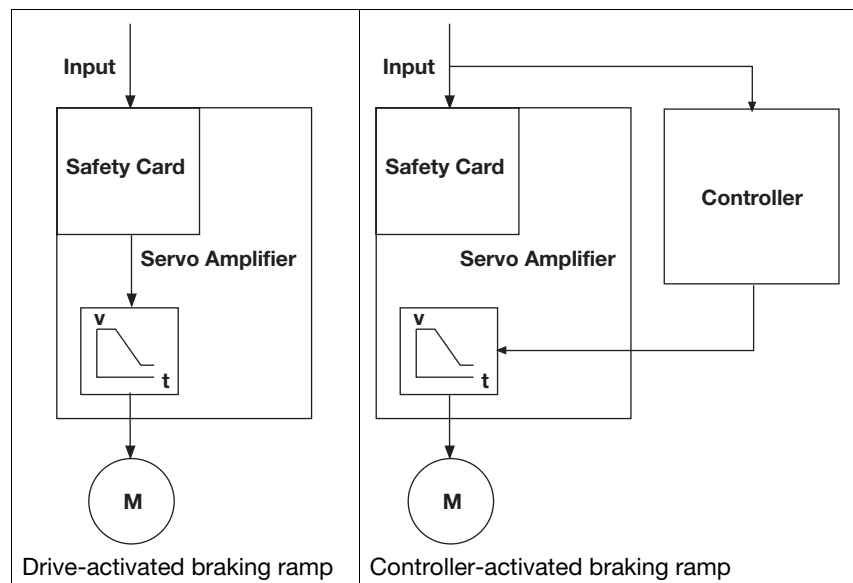

Reaction:

- ▶ Controlled braking of the drive, with the configured braking ramp.
- ▶ The drive remains in a controlled standstill and is monitored for "safe standstill".
- ▶ "SOS Acknowledge" output: "1" Signal

4.3 Safety functions

Timing diagram

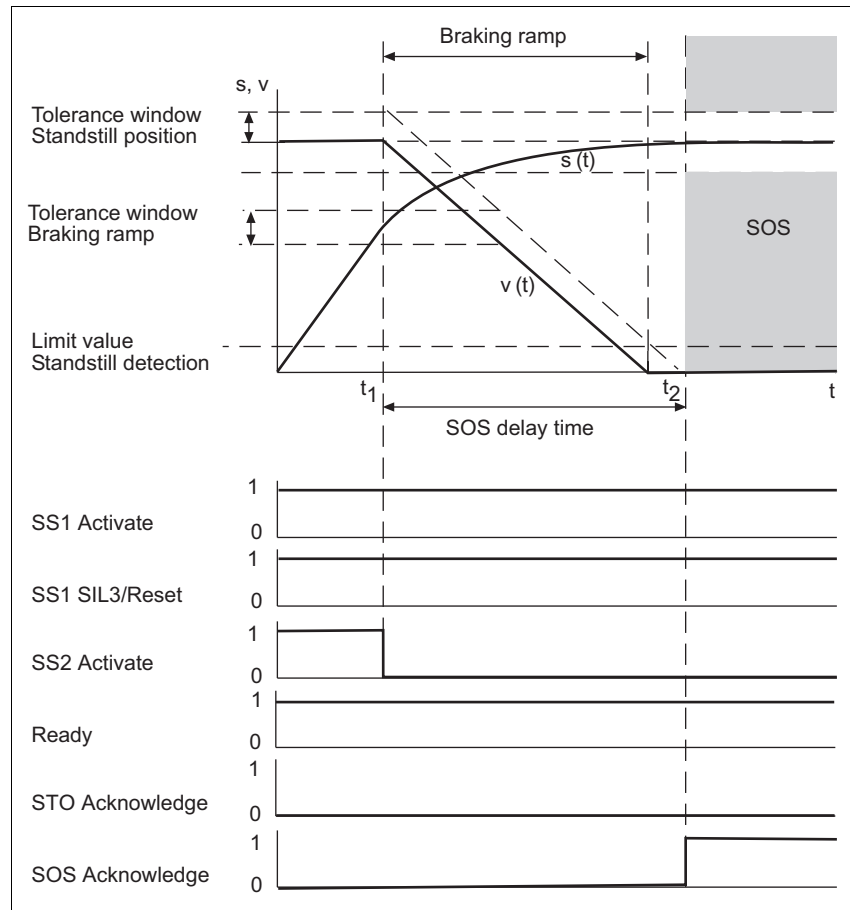

Fig. 4-4: Safety function SS2

- ▶ t_1 : Activation of safety function SS2
- ▶ t_2 : Activation of safety function SOS
- ▶ SS1 Activate: Input for safety function SS1
- ▶ SS1 SIL3/Reset: Input for SIL3 and reset
- ▶ Ready: Output for operating status of the safety card
- ▶ STO Acknowledge: Output for feedback from safety function STO
- ▶ SOS Acknowledge: Output for feedback from safety function SOS

4.3 Safety functions

4.3.4 Safe operating stop - SOS

The safety function "safe operating stop" (SOS) monitors the standstill position that has been reached. An error will activate safety function SS1 (E-STOP braking ramp).

Features of the safety function:

- ▶ The drive's control functions are maintained in the standstill position.
- ▶ Power to the motor is not shut down.

The safety card monitors the following functions:

- ▶ Standstill position
 - The safety function monitors whether the standstill position remains within a configured tolerance window.
 - Safety function SS1 (E-STOP braking ramp) is activated if the standstill position leaves the tolerance window.
- ▶ Automatic SOS at standstill

A standstill threshold for activating the safety function SOS can be specified in the Configurator.

Safety function SOS is activated when

 - standstill is achieved while the SOS delay time is running.
 - the SOS delay time has elapsed.

Prerequisites for normal operation:

- ▶ Input "SS1 Activate" and "SS1 SIL3/Reset": "1" Signal (+24 VDC)
- ▶ "Ready" output: "1" Signal (+24 VDC). The safety card is ready for operation.
- ▶ "STO Acknowledge" output: "0" Signal
- ▶ Input "SOS Activate": "1" Signal (+24 VDC)
- ▶ To achieve SIL3 or Ple: Connect the output "STO SIL3" to servo amplifier terminal X4A/ 3.

Safety function is activated

- ▶ By a 1/0 pulse edge at the input "SOS Activate".

Reaction:

- ▶ SOS delay time starts
- ▶ Once the SOS delay time has elapsed, safe standstill is monitored. The drive remains in a controlled standstill.
- ▶ Output "SOS Acknowledge": "1" Signal
- ▶ Safety function SS1 (E-STOP braking ramp) shuts the drive down safely if the limit value for the standstill position is exceeded. An error is registered.

4.3 Safety functions

Timing diagram

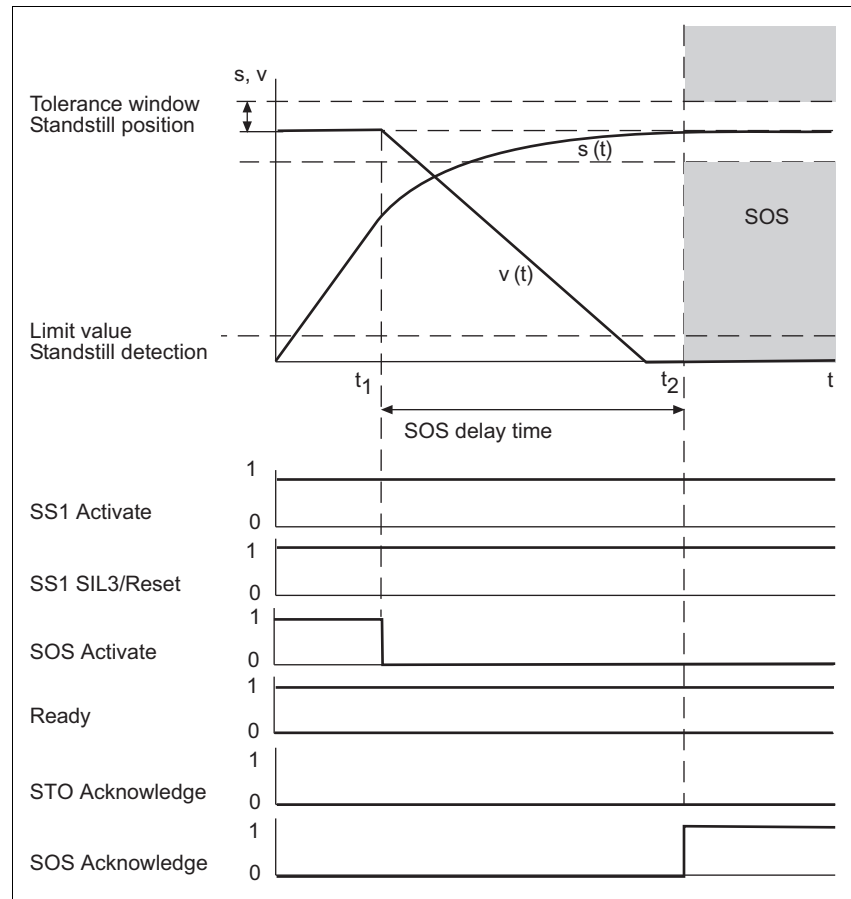

Fig. 4-5: Safety function SOS

- ▶ t1: Activation of safety function SOS
- ▶ t2: Once the SOS delay time has elapsed, standstill position is monitored
- ▶ SS1 Activate: Input for safety function SS1
- ▶ SS1 SIL3/Reset: Input for SIL3 and reset
- ▶ SOS-Activate: Input for safety function SOS
- ▶ Ready: Output for operating status of the safety card
- ▶ STO Acknowledge: Output for feedback from safety function STO
- ▶ SOS Acknowledge: Output for feedback from safety function SOS

4.3 Safety functions

4.3.5 Safely limited speed - SLS

The safety function "safely limited speed" (SLS) monitors the drive to check that it stays within a defined speed limit.

Prerequisites for normal operation:

- ▶ Input "SS1 Activate" and "SS1 SIL3/Reset": "1" Signal (+24 VDC)
- ▶ "Ready" output: "1" Signal (+24 VDC). The safety card is ready for operation.
- ▶ "STO Acknowledge" output: "0" Signal
- ▶ Input "SLS Activate": "1" Signal (+24 VDC)
- ▶ To achieve SIL3 or Plc: Connect the output "STO SIL3" to servo amplifier terminal X4A/ 3.

Safety function is activated

- ▶ By a 1/0 pulse edge at the input "SLS Activate".

Reaction:

- ▶ SLS delay time starts
- ▶ Once the SLS delay time has elapsed, the speed is monitored.
- ▶ Output "SRA Acknowledge": "1" Signal
- ▶ If the limit value is exceeded, safety function SS1 (E-STOP braking ramp) is activated.

A tolerance range may also be set for the limit values used to monitor the speed. This tolerance range modifies the set limit values. As a result, one-off or periodic overshoots that exceed the limit values can be tolerated.

The following values can be set for the tolerance range:

- ▶ Tolerance amount, which takes into account the size of the overshoots.
- ▶ Tolerance time, which takes into account the length of the overshoots
- ▶ Tolerance period that takes into account the variation period



INFORMATION

See the Configurator's online help for details of how to set the parameters for the tolerance range.

Activate the tolerance range:

- ▶ The tolerance range becomes active the first time the speed limit value is exceeded (see flowchart).

4.3 Safety functions

Reaction:

- ▶ If the tolerance range is exceeded, the safety function SS1 (E-STOP braking ramp) is activated.

The following diagrams illustrate the sequences, with and without the tolerance range activated.

Timing diagram without tolerance range activated

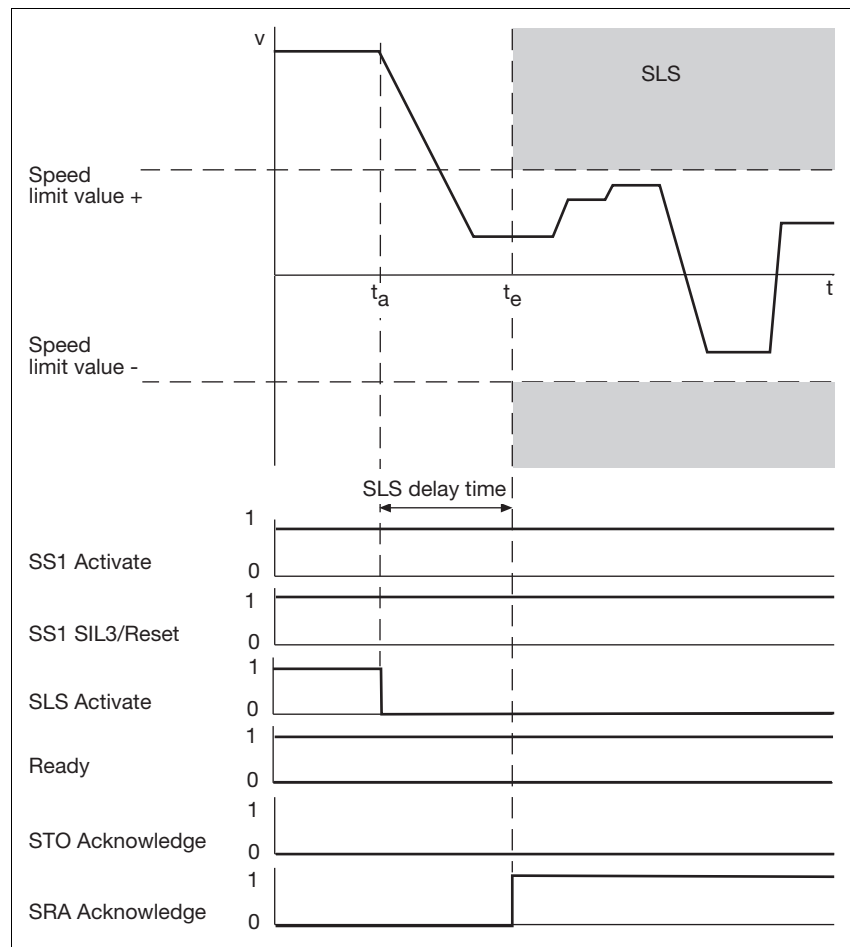

Fig. 4-6: Safety function SLS without tolerance range activated

- ▶ t_a : Activation of safety function SLS
- ▶ t_e : Once the SLS delay time has elapsed, the speed is monitored
- ▶ SS1 Activate: Input for safety function SS1
- ▶ SS1 SIL3/Reset: Input for SIL3 and reset
- ▶ SLS Activate: Input for safety function SLS
- ▶ Ready: Output for operating status of the safety card
- ▶ STO Acknowledge: Output for feedback from safety function STO

4.3 Safety functions

- ▶ SRA Acknowledge: Output for monitoring the limit value on the motor

Timing diagram with tolerance range activated

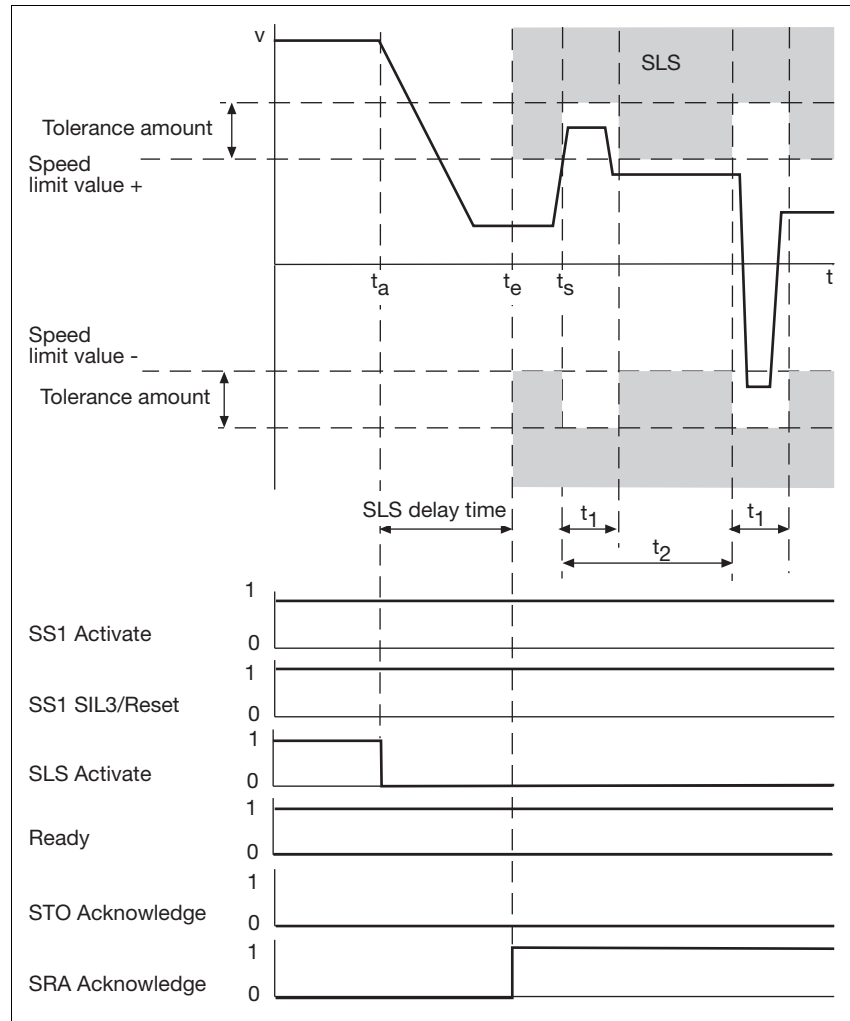

Fig. 4-7: Safety function SLS with tolerance range activated

- ▶ Tolerance amount as % of the speed limit value
- ▶ t_a : Activation of safety function SLS
- ▶ t_e : Once the SLS delay time has elapsed, the speed is monitored
- ▶ t_s : Speed v exceeds the limit value and activates the tolerance range (tolerance amount, tolerance time, tolerance period)
- ▶ t_1 : Tolerance time
- ▶ t_2 : Tolerance period
- ▶ SS1 Activate: Input for safety function SS1
- ▶ SS1 SIL3/Reset: Input for SIL3 and reset
- ▶ SLS Activate: Input for safety function SLS

4.3 Safety functions

- ▶ Ready: Output for operating status of the safety card
- ▶ STO Acknowledge: Output for feedback from safety function STO
- ▶ SRA Acknowledge: Output for monitoring the limit value on the motor

4.3.6 Safe speed range - SSR

The safety function "safe speed range" (SSR) monitors the drive's current speed to ensure it stays within a maximum and minimum permitted limit value.

Prerequisites for normal operation:

- ▶ Input "SS1 Activate" and "SS1 SIL3/Reset": "1" Signal (+24 VDC)
- ▶ "Ready" output: "1" Signal (+24 VDC). The safety card is ready for operation.
- ▶ "STO Acknowledge" output: "0" Signal
- ▶ Input "SSR Activate": "1" Signal (+24 VDC)
- ▶ To achieve SIL3 or Ple: Connect the output "STO SIL3" to servo amplifier terminal X4A/ 3.

Safety function is activated

- ▶ By a 1/0 pulse edge at the input "SSR Activate".

Reaction:

- ▶ SSR delay time starts
- ▶ Once the SSR delay time has elapsed, the speed is monitored.
- ▶ Output "SRA Acknowledge": "1" Signal
- ▶ If the limit value is exceeded, safety function SS1 is activated.

A tolerance range may also be set for the limit values used to monitor the speed. This tolerance range modifies the set limit values. As a result, one-off or periodic overshoots that exceed the limit values can be tolerated.

The following values can be set for the tolerance range:

- ▶ Tolerance amount, which takes into account the size of the overshoots.
- ▶ Tolerance time, which takes into account the length of the overshoots
- ▶ Tolerance period that takes into account the variation period



INFORMATION

See the Configurator's online help for details of how to set the parameters for the tolerance range.

4.3 Safety functions

Activate the tolerance range:

- ▶ The tolerance range becomes active the first time the speed limit value is exceeded (see flowchart).

Reaction:

- ▶ If the tolerance range is exceeded, the safety function SS1 (E-STOP braking ramp) is activated.

The following diagrams illustrate the sequences, with and without the tolerance range activated.

Timing diagram without tolerance range activated

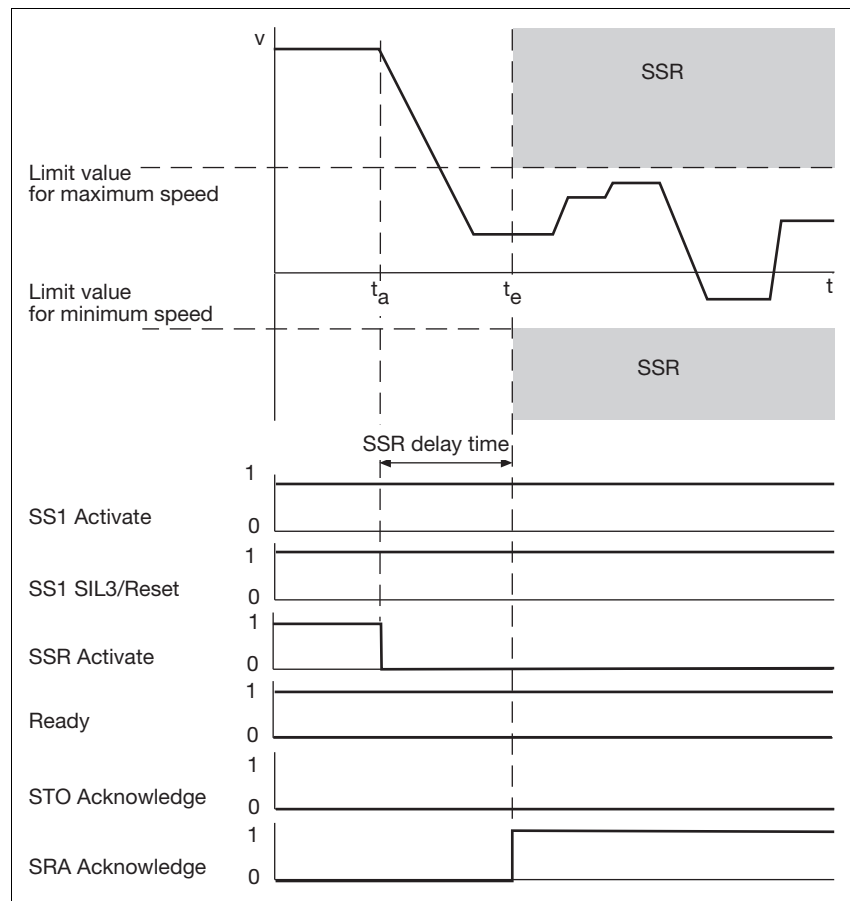

Fig. 4-8: Safety function SSR without tolerance range activated

- ▶ t_a : Activation of safety function SSR
- ▶ t_e : Once the SSR delay time has elapsed, the speed is monitored
- ▶ SS1 Activate: Input for safety function SS1
- ▶ SS1 SIL3/Reset: Input for SIL3 and reset

4.3 Safety functions

- ▶ SSR Activate: Input for safety function SLS
- ▶ Ready: Output for operating status of the safety card
- ▶ STO Acknowledge: Output for feedback from safety function STO
- ▶ SRA Acknowledge: Output for monitoring the limit value on the motor

Timing diagram with tolerance range activated

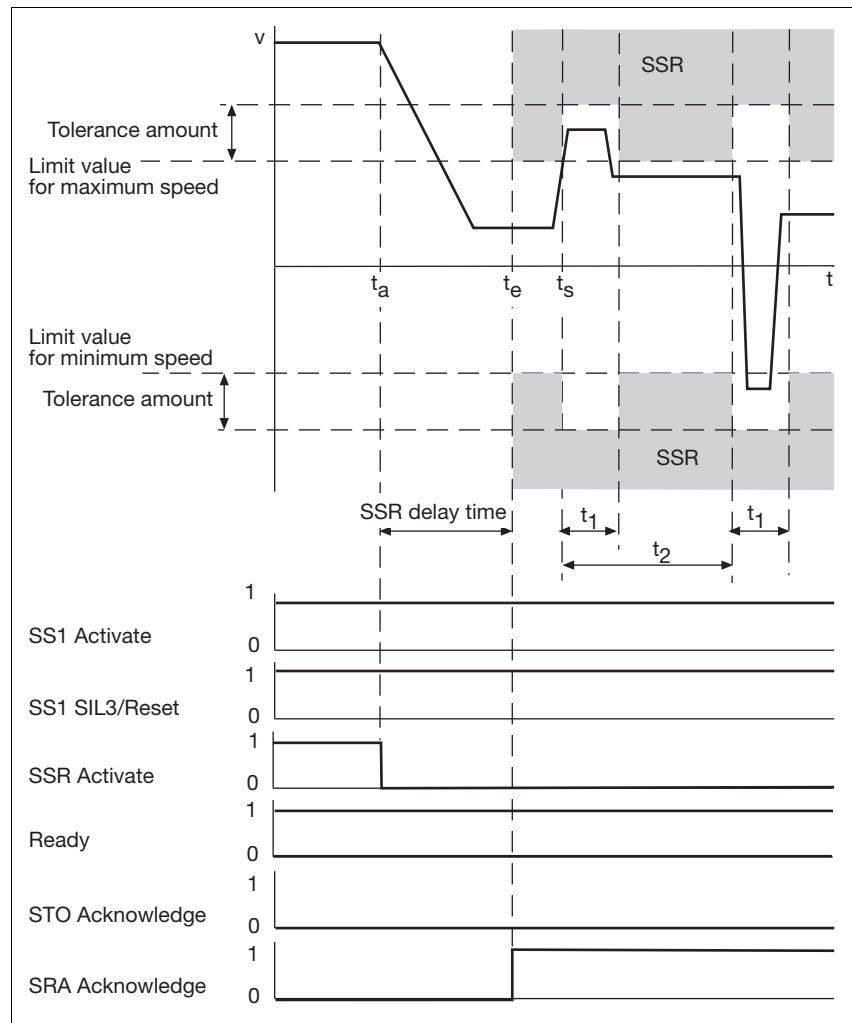

Fig. 4-9: Safety function SSR with tolerance range activated

- ▶ Tolerance amount as % of the two limit values, maximum and minimum speed
- ▶ t_a : Activation of safety function SSR
- ▶ t_e : Once the SSR delay time has elapsed, the speed is monitored
- ▶ t_s : Speed v exceeds the limit value and activates the tolerance range (tolerance amount, tolerance time, tolerance period)
- ▶ t_1 : Tolerance time

4.3 Safety functions

- ▶ t_2 : Tolerance period
- ▶ SS1 Activate: Input for safety function SS1
- ▶ SS1 SIL3/Reset: Input for SIL3 and reset
- ▶ SSR Activate: Input for safety function SLS
- ▶ Ready: Output for operating status of the safety card
- ▶ STO Acknowledge: Output for feedback from safety function STO
- ▶ SRA Acknowledge: Output for monitoring the limit value on the motor

4.3.7 Safe direction - SDI

The safety function "safe direction" (SDI) monitors the defined direction of rotation of the drive axis (clockwise or anti-clockwise).

Prerequisites for normal operation:

- ▶ Input "SS1 Activate" and "SS1 SIL3/Reset": "1" Signal (+24 VDC)
- ▶ "Ready" output: "1" Signal (+24 VDC). The safety card is ready for operation.
- ▶ "STO Acknowledge" output: "0" Signal
- ▶ Input "SDI Pos Activate": "1" Signal (+24 VDC)
- ▶ Input "SDI Neg Activate": "1" Signal (+24 VDC)
- ▶ To achieve SIL3 or Ple: Connect the output "STO SIL3" to servo amplifier terminal X4A/ 3.

Safety function is activated

- ▶ By a 1/0 pulse edge at the input "SDI Pos Activate".
or
- ▶ By a 1/0 pulse edge at the input "SDI Neg Activate".

Reaction:

- ▶ SDI delay time starts
- ▶ Once the SDI delay time has elapsed, the direction of rotation is monitored
- ▶ "SDI Acknowledge" output: "1" Signal
- ▶ If the direction of rotation is violated, safety function SS1 (E-STOP braking ramp) is activated.

4.3 Safety functions

Timing diagram

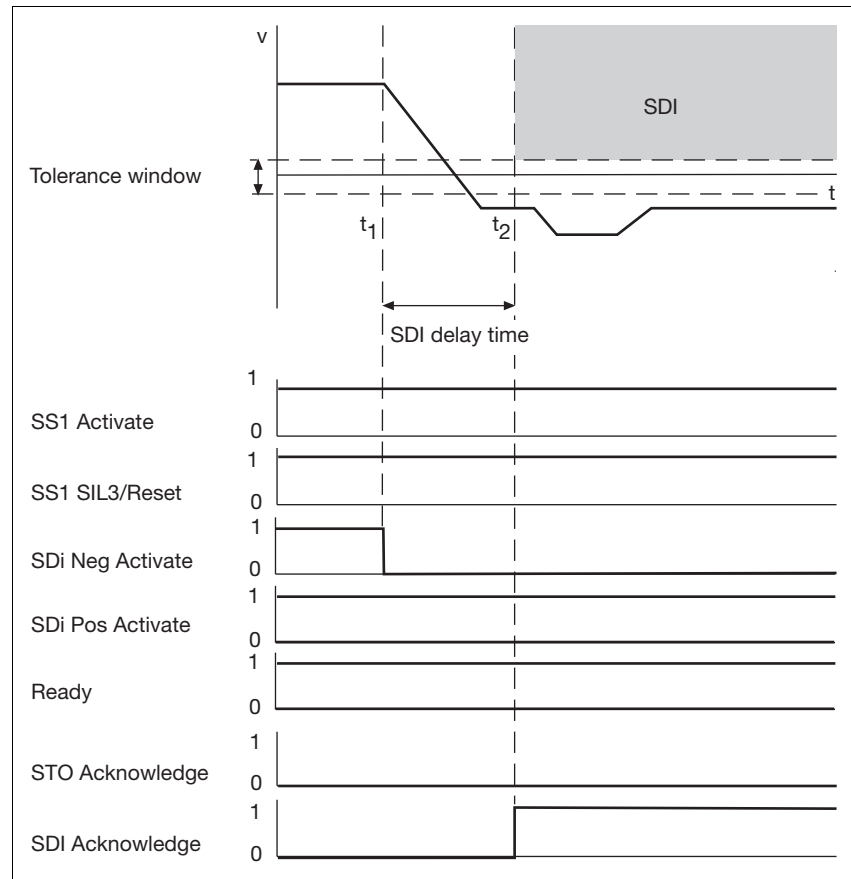

Fig. 4-10: Safety function SDI

- ▶ t_1 : Activation of safety function SDI
- ▶ t_2 : Once the SDI delay time has elapsed, the direction of rotation is monitored
- ▶ SS1 Activate: Input for safety function SS1
- ▶ SS1 SIL3/Reset: Input for SIL3 and reset
- ▶ SDi Pos Activate: Input for safety function SDI, clockwise rotation is monitored
- ▶ SDi Neg Activate: Input for safety function SDI, anti-clockwise rotation is monitored
- ▶ Ready: Output for operating status of the safety card
- ▶ STO Acknowledge: Output for feedback from safety function STO
- ▶ SDI Acknowledge: Output for feedback from safety function SDI

Switching the direction of rotation while safety function SDI is active

- ▶ When changing the direction of the motor, please note: Monitoring of the old direction must be deactivated first, before monitoring of the new direction of rotation is activated! (See Case A in the illustration).

4.3 Safety functions

If an SDI delay time t_m has been configured, it will start when the new direction of rotation monitoring is activated. In A, the SDI delay time t_m is shown = 0.

- ▶ The SDI delay time can be used to optimise the time taken to switch the direction of rotation. The new direction can be activated while the SDI delay time t_m is running. Only then is monitoring of the old direction of rotation deactivated (see Case B in the illustration and timing diagram).



NOTICE

Please note that the direction of rotation may only ever be monitored in one direction. The safety function SS1 will trigger if monitoring in both directions is activated simultaneously.

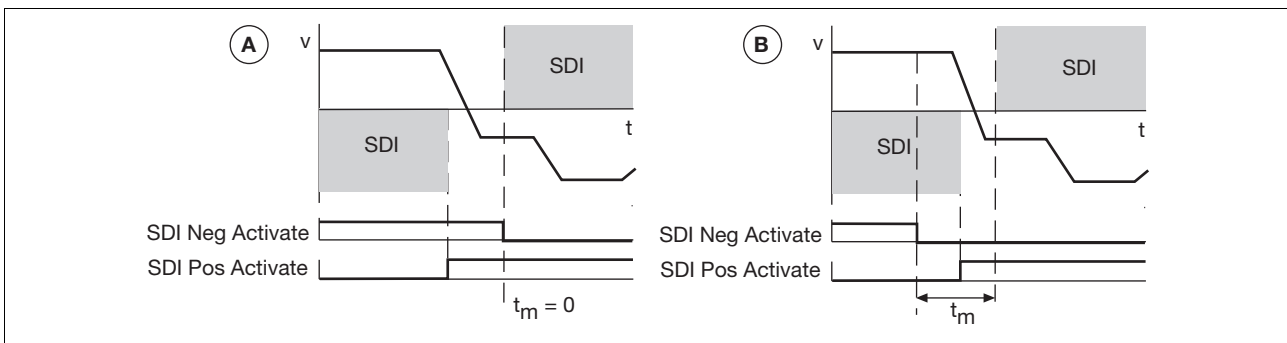

Fig. 4-11: Changing the direction of rotation

4.3 Safety functions

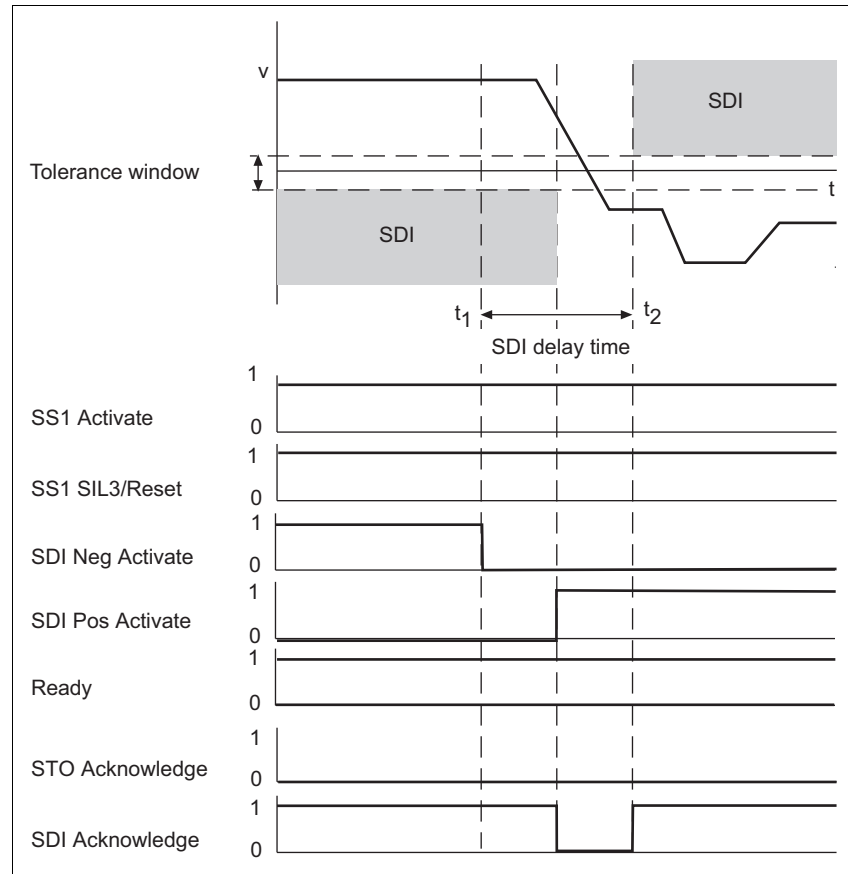

Fig. 4-12: Changing the direction of rotation with SDI delay time

- ▶ t_1 : Activation of safety function SDI in negative direction of rotation
- ▶ t_2 : Once the SDI delay time has elapsed, the negative direction of rotation is monitored
- ▶ SS1 Activate: Input for safety function SS1
- ▶ SS1 SIL3/Reset: Input for SIL 3 and reset
- ▶ SDI Neg Activate: Input for safety function SDI, anti-clockwise rotation is monitored (new direction of rotation)
- ▶ SDI Pos Activate: Input for safety function SDI, clockwise rotation is monitored (old direction of rotation)
- ▶ Ready: Output for operating status of the safety card
- ▶ STO Acknowledge: Output for feedback from safety function STO
- ▶ SDI Acknowledge: Output for feedback from safety function SDI

4.3 Safety functions

4.3.8 Safe brake control - SBC

The safety function "safe brake control" (SBC) is used to control external brakes.

Features of the safety function:

- ▶ After executing safety functions STO and SS1, an additional mechanical brake is required to eliminate hazards, particularly where external forces influence the motor axis (e.g. suspended loads).
- ▶ The internal motor brake is controlled directly from the servo amplifier when the motor is switched on/off.
- ▶ An external mechanical brake is controlled via the 2-pole output "SBC+/SBC-" on the safety card.
- ▶ Safety function SBC is activated in conjunction with safety function STO. SBC must be activated in the Configurator for this purpose.



NOTICE

Please note: when using a safe holding brake on vertical axes, a motor brake must be available.

Prerequisites for normal operation:

- ▶ Input "SS1 Activate" and "SS1 SIL3/Reset": "1" Signal (+24 VDC)
- ▶ "Ready" output: "1" Signal (+24 VDC). The safety card is ready for operation.
- ▶ "STO Acknowledge" output: "0" Signal
- ▶ Output "SBC+/SBC-": "1" Signal (+24 VDC)
- ▶ Both outputs are simultaneously set to a "1" Signal: Voltage difference of 24 V between SBC+ and SBC-.
- ▶ To achieve SIL3 or Ple: Connect the output "STO SIL3" to servo amplifier terminal X4A/ 3.

Safety function is activated

- ▶ Safety function STO

Reaction:

- ▶ Output "SBC+/SBC-": "0" Signal (0 VDC)
- ▶ Both outputs are simultaneously set to a "0" Signal: Voltage difference of 0 V between SBC+ and SBC-.

4.3 Safety functions

Timing diagram

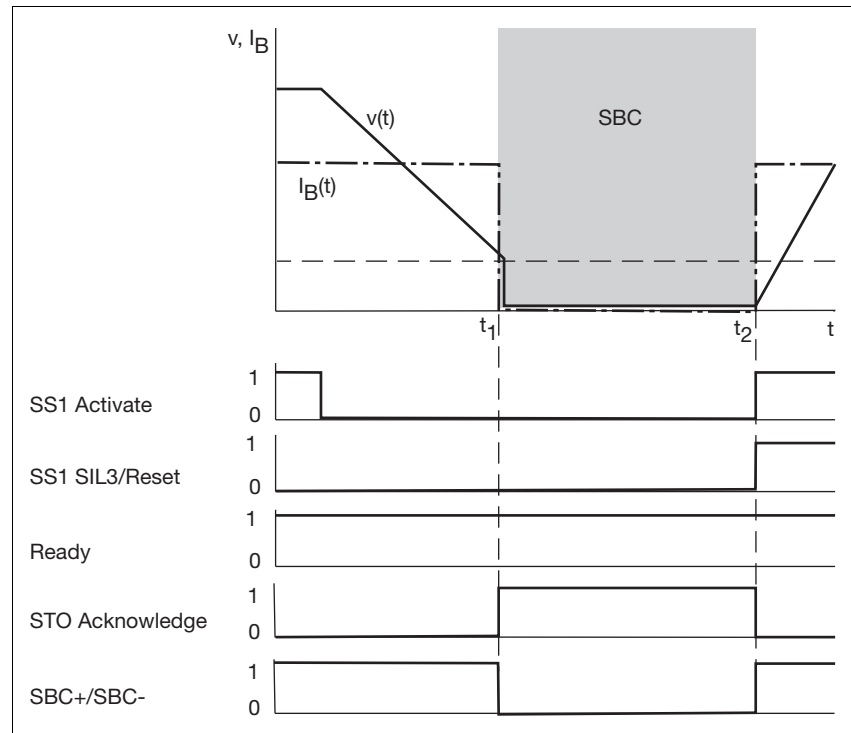

Fig. 4-13: Safety function SBC

- ▶ t_1 : Activation of safety function STO and SBC
- ▶ t_2 : End of safety function SBC
- ▶ SS1 Activate: Input for safety function SS1
- ▶ SS1 SIL3/Reset: Input for SIL3 and reset
- ▶ Ready: Output for operating status of the safety card
- ▶ STO Acknowledge: Output for feedback from safety function STO
- ▶ SBC+: Brake control output

4.3.9 Safe brake test - SBT

The safety function "safe brake test" (SBT) is used to test the external (holding brake) plus the internal brake (motor brake).

Features of the safety function:

- ▶ The servo amplifier receives a command to control the motor brake from the safety card, via the internal interface.
- ▶ An external mechanical brake is controlled via the 2-pole output "SBC+/SBC-" on the safety card.

4.3 Safety functions

The safety card monitors the following functions:

- ▶ During the brake test, the safety function SOS performs position monitoring.
- ▶ The brake test must be carried out cyclically within a defined test period, after 8 hours at the latest.
- ▶ The test period and tolerance time can be set in the Configurator.

Prerequisites for normal operation:

- ▶ Input "SS1 Activate" and "SS1 SIL3/Reset": "1" Signal (+24 VDC)
- ▶ "Ready" output: "1" Signal (+24 VDC). The safety card is ready for operation.
- ▶ "STO Acknowledge" output: "0" Signal
- ▶ Output "SBC+/SBC-": "1" Signal (+24 VDC)
- ▶ Both outputs are simultaneously set to a "1" Signal: Voltage difference of 24 V between SBC+ and SBC-.
- ▶ Input "SBT Activate": "1" Signal (+24 VDC)
- ▶ To achieve SIL3 or PlE: Connect the output "STO SIL3" to servo amplifier terminal X4A/ 3.

Safety function is activated

- ▶ By a 1/0 pulse edge at the input "SBT Activate".

Reaction:

When two brakes are present (motor brake and external mechanical brake), the cycle $t_2 - t_5$ is repeated for the second brake (see timing diagram).

- ▶ SBT delay time starts
- ▶ After SBT delay time: Output "SBC+": "0" Signal, brakes engage
- ▶ After delay time: Motor is supplied with 1.3 times the value of the maximum load.

Forces or torques that already affect the axis must be considered in the measurement, e.g. suspended loads.

- ▶ During the defined period, the safety function SOS monitors the standstill position
- ▶ Brake is vented
- ▶ Output "SBT Acknowledge": "1" Signal. Brake test successful

4.3 Safety functions

Timing diagram

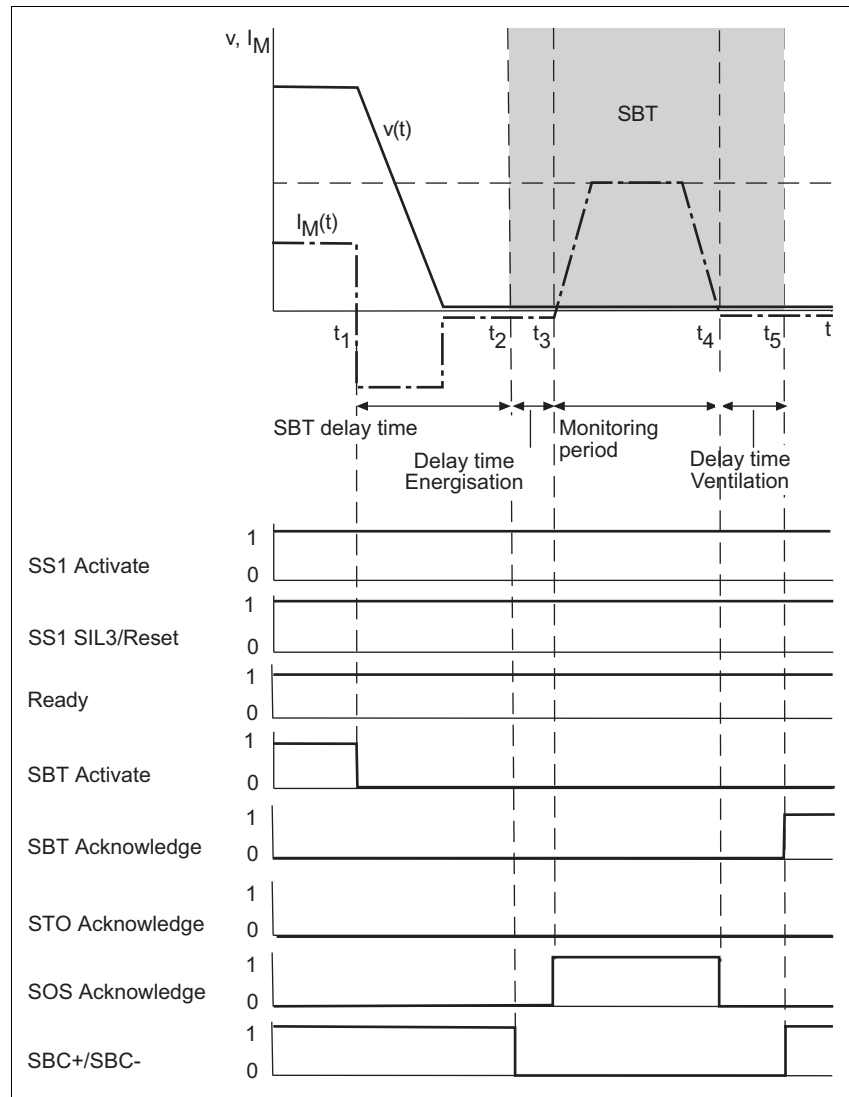

Fig. 4-14: Safety function SBT

- ▶ t_1 : Activation of safety function SBT, start of SBT delay time
- ▶ t_2 : Start of brake test, brake engages
- ▶ t_3 : Start of monitoring period, power is supplied to the motor
- ▶ t_4 : End of monitoring period
- ▶ t_5 : End of brake test
- ▶ SS1 Activate: Input for safety function SS1
- ▶ SS1 SIL3/Reset: Input for SIL3 and reset
- ▶ Ready: Output for operating status of the safety card
- ▶ SBT Activate: Input for safety function SBT
- ▶ SBT Acknowledge: Output for feedback from safety function SBT
- ▶ STO Acknowledge: Output for feedback from safety function STO

4 Function Description

4.3 Safety functions

- ▶ SOS Acknowledge: Output for feedback from safety function SOS
- ▶ SBC+: Brake control output

4.4 Operating mode of the servo amplifier

Activation of safety functions SS1 and SS2 has repercussions on the servo amplifier's operating mode:

SS1 when OPMODE = 0 ... 8

- ▶ The drive-activated safety function "safe stop 1" (SS1) behaves the same in all of the servo amplifier's operating modes, as ultimately the movement is not continued. The safety card must be reset to resume operation.
- ▶ The status of the safety card (SS1 activated) is transmitted to the servo amplifier. As a result, the information is available to a higher level control system (status word).
- ▶ The transfer of setpoint values from external servo amplifier interfaces (bus system or analogue input) is disabled.
- ▶ The servo amplifier applies speed-controlled braking with the preset braking ramp until standstill is achieved, and disables the servo amplifier's power element.
- ▶ When the set delay time has elapsed, the safety card activates the safety function STO. The servo amplifier cannot be restarted.

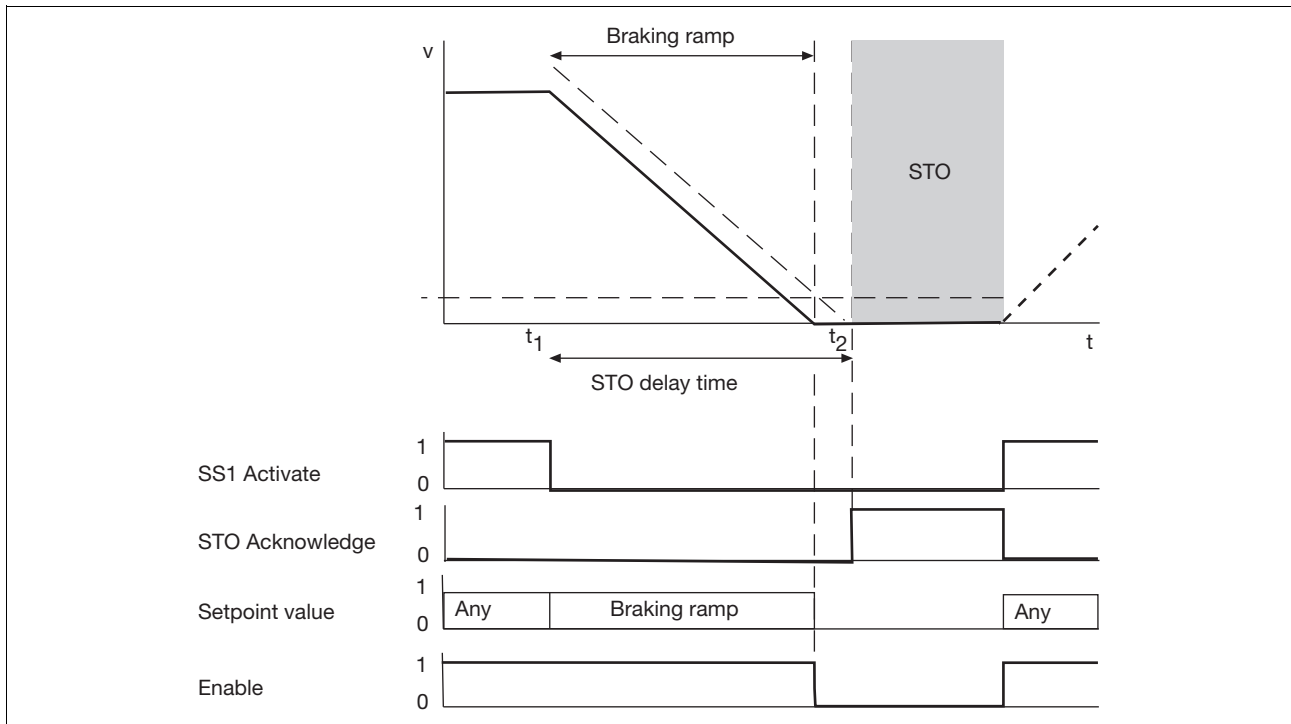

- ▶ SS1 Activate: Input for safety function SS1
- ▶ STO Acknowledge: Output for feedback from safety function STO
- ▶ Setpoint value: Specification of setpoint values
- ▶ Enable: Servo amplifier's readiness for operation

4.4 Operating mode of the servo amplifier

SS2 when OPMODE = 0 ... 8

- ▶ With the drive-activated safety function "safe stop 2" (SS2), the movement is ultimately continued.
- ▶ The status of the safety card (SS2 activated) is transmitted to the servo amplifier. As a result, the information is available to a higher level control system (status word).
- ▶ The transfer of setpoint values from external servo amplifier interfaces (bus system or analogue input) is disabled.
- ▶ The servo amplifier applies speed-controlled braking with the preset braking ramp until standstill is achieved. This status is maintained for as long as safety function SS2 is active.
- ▶ If safety function SS2 is deactivated, the status word is updated.
- ▶ The servo amplifier automatically switches to the OPMODE that was originally set.
- ▶ The transfer of setpoint values from external servo amplifier interfaces (bus system or analogue input) is once again permitted.
- ▶ When OPMODE = 8, the existing motion block can be continued via the "CONTINUE" command.

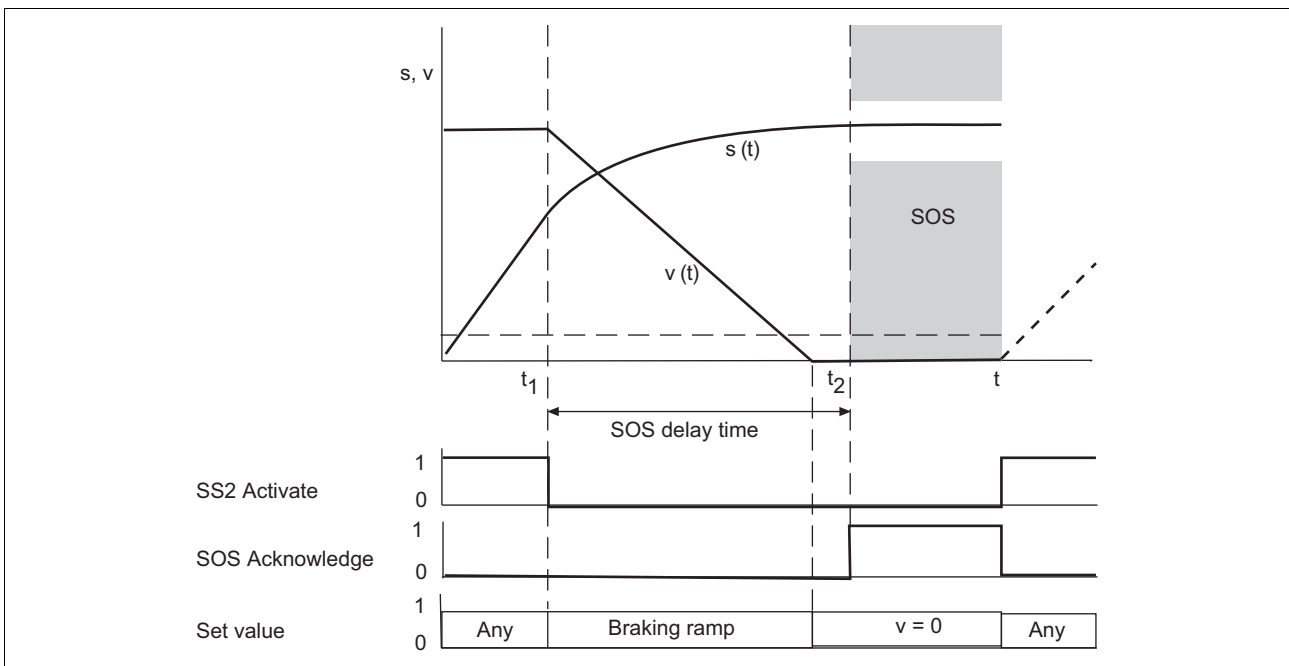

- ▶ SS2 Activate: Input for safety function SS2
- ▶ SOS Acknowledge: Output for feedback from safety function SOS
- ▶ Setpoint value: Specification of setpoint values



INFORMATION

Further information on the command can be found in the servo amplifier's online help.

4.5 Reaction times

The reaction times refer exclusively to the inputs and outputs on a servo amplifier with safety card when:

- ▶ The signal at the inputs changes
- ▶ The limit value is exceeded
- ▶ Internal errors are present

To determine the overall reaction times, the corresponding internal processing times in the servo amplifier, bus systems, periphery devices and controllers must also be taken into account.

Processing time of the digital input

The response and error reaction time takes into account the following processing times:

- ▶ Processing time of digital input T_{IN} : The time it takes for a "0" or "1" signal in the safety card to be detected once a signal has changed at the input. The processing time takes into account the input filter time, temperature drift, spread of components, etc.
- ▶ Internal processing times of the safety card
 - T_{CYCLE} : Scan time of the safety card's processor system
 - T_{OUT} : Processing time for the safety card's shutdown path
- ▶ T_{PULSE} : Processing time for the safe pulse disabler in the servo amplifier

Response time:

- ▶ The time it takes for the shutdown signal to be provided for the servo amplifier's power element, once a signal has changed at the input
 $T_{IN} + T_{CYCLE} + T_{OUT} + T_{PULSE}$

Error reaction time:

- ▶ The time it takes for the shutdown signal to be provided for the servo amplifier's power element, once a limit value has been exceeded or an internal error has occurred.

$$T_{CYCLE} + T_{OUT} + T_{PULSE}$$

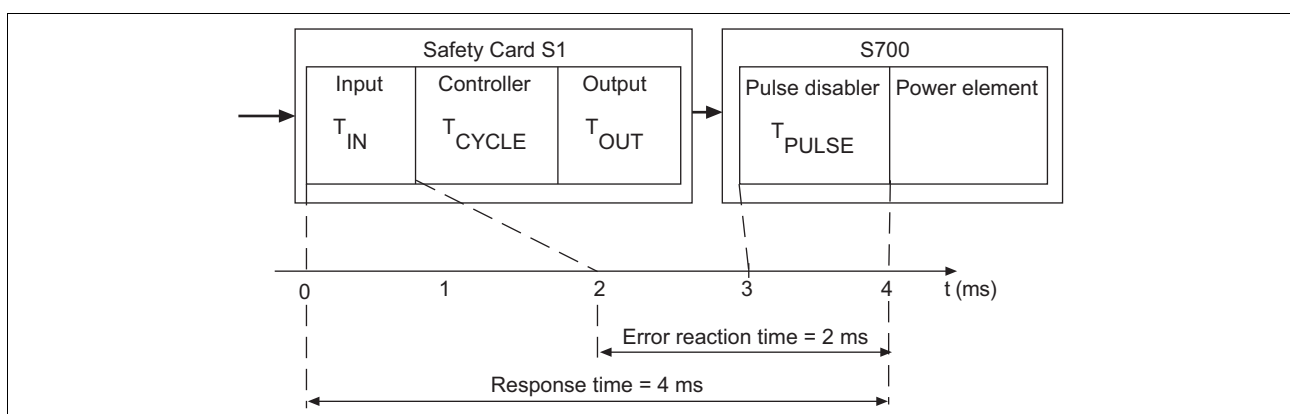

4.6 Configuration

The safety functions to be carried out by the safety card are defined in the safety card's configurator:

- ▶ Configuration of the safety functions
- ▶ Setting of limit values, braking ramps for the safety functions, monitoring of motion sequences

Download configuration:

- ▶ On single-axis systems, via the RS 232 interface on the servo amplifier
- ▶ On networked systems, via the RS 232 or Ethernet interface on the motion control system. The control system passes the configuration to the respective safety card.

Download configuration to safety card:

- ▶ Online from configurator to safety card.
- ▶ Save configuration to external SD card.
- ▶ Order and serial numbers must be entered in the configuration to ensure the safety card is addressed securely.
- ▶ The feasibility of the configuration is checked as it is downloaded.
- ▶ Enabling of the power element after download depends on the status of the inputs on the safety card.

Upload configuration from safety card:

- ▶ Online from safety card to configurator
- ▶ Save safety card configuration to SD card in the servo amplifier.
- ▶ The feasibility of the configuration is checked as it is uploaded.



INFORMATION

Further information on the configuration and parameter settings for the safety functions is available in the safety card configurator's online help.

4 Function Description

5.1 General requirements

Please also refer to the instruction manual for the servo amplifier.



CAUTION!

Damage due to electrostatic discharge!

Electrostatic discharge can damage components. Ensure discharge before touching the safety card, e.g. by touching an earthed, conductive surface or by wearing an earthed armband.

5.2 Dimensions

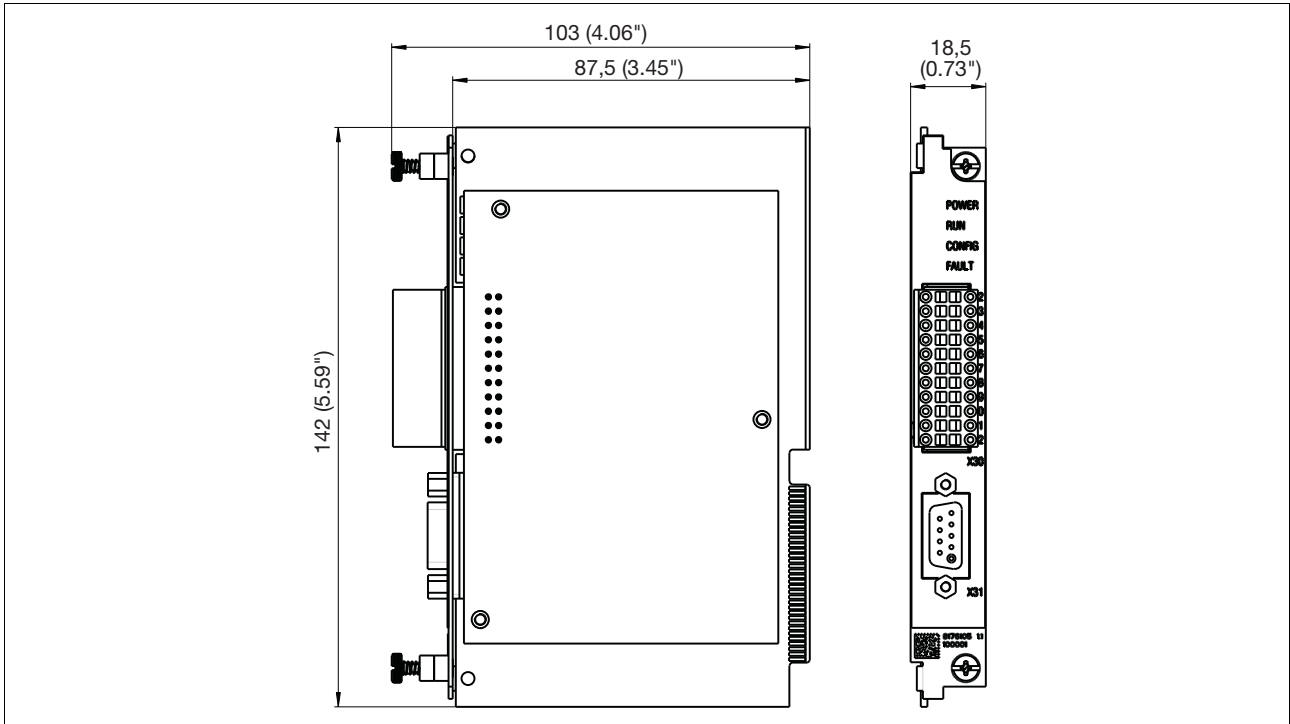

Fig. 5-1: Dimensions stated in mm (")

5.3 Installing the safety card

The expansion card is installed in slot 3 of the servo amplifier. When installing, please note the guidelines given under "Installation" in the instruction manual for the servo amplifier.

6.1 General wiring guidelines

Inputs

- ▶ Appropriate wiring must be used to exclude short circuits between the inputs or to a supply line!
- ▶ Signal lines must be shielded.

Outputs

- ▶ If short circuits occur between the cable from the output to the load and a supply line, it will no longer be possible to switch off the load.
Possible remedy: Exclude the error by using separate multicore cable for supply voltages
- ▶ Use appropriate wiring to exclude short circuits between the outputs!
- ▶ Signal lines must be shielded.
- ▶ The outputs do not need suppression for inductive loads.

Cable material

- ▶ Use copper wiring.

Please note:

- ▶ Cable cross sections for field connection terminals in mm²:
 - Digital inputs/outputs, supply voltage: 0.5 (AWG20) ... 1.0 (AWG18), AEH without plastic collar, in accordance with DIN 46228/1
- ▶ Max. cable lengths
 - Supply voltage: Max. 30 m
 - Digital inputs and outputs: Max. 30 m

6.2 Connector pin assignment

X30	Pin	Name	Description
<p style="text-align: center;">X30</p>	1	SS1 Activate	Activate safety function SS1
	2	SS2 Activate	Activate safety function SS2
	3	SOS Activate	Activate safety function SOS
	4	SLS Activate	Activate safety function SLS
	5	STO Acknowledge	Status: STO activated
	6	SOS Acknowledge	Status: SOS activated
	7	SDI Acknowledge	Status: SDI activated
	8	SRA Acknowledge	Status: SSR or SLS activated
	9	SBT Acknowledge	Status: Brake test performed
	10	24 V Supply	Supply voltage for digital outputs (24 VDC)
	11	Encoder Supply	Supply voltage for external encoder
	12	SSR Activate	Activate safety function SSR
	13	SDI Neg Activate	Activate safety function SDI (anti-clockwise)
	14	SDI Pos Activate	Activate safety function SDI (clockwise)
	15	SBT Activate	Activate safety function SBT
	16	Ready	Status: Safety card ready for operation
	17	SBC+	Output to control external brake +
	18	SBC-	Output to control external brake -
	19	STO SIL3	Output, single-pole
	20	SS1 SIL3/Reset	Input for SIL3 and reset
	21	0 V Supply ¹⁾	Supply voltage for digital outputs (0 V)
	22	0 V Encoder Supply ¹⁾	Supply voltage for external encoder (0 V)
¹⁾ Pin 21, 22 linked internally			

6.3 Shielding

For immunity reasons, the signal lines for the digital inputs, outputs and encoder must be shielded:

- ▶ All shielded cables are to be attached at both ends to the shield terminals provided or should be connected to the connector housing.
- ▶ Use cables with a braided shield, with a minimum coverage of 80 %.
- ▶ Any interruptions to the shielding e.g. at terminals, should be bridged at low impedance over a wide area.
- ▶ All connectors or sockets should be fastened with screws to ensure ample, conductive contact between the braided shield and the front plate.

The shield for the encoder's signal lines is connected to the connector housings.

The shields for the digital inputs and outputs should be connected to the front of the servo amplifier, as shown in the diagram below.

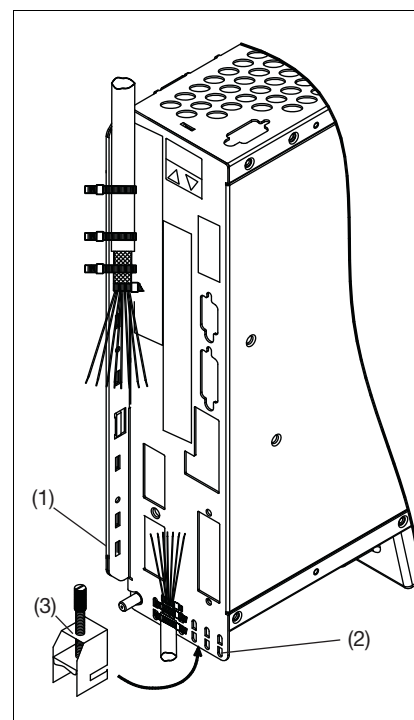

Remove the outer cable sheath and the braided shield to the required wire length. Secure the wires with a cable tie.

Remove the outer cable sheath to a length of approx. 30 mm. Be careful not to damage the braided shield.

Strip all the wires and fit end ferrules.

Use the cable ties to attach the cable to the shielding plate on the side (1) or bottom (2) of the servo amplifier. Press the cable's braided shield firmly against the shielding plate on the servo amplifier using a cable tie.

Alternatively you can use the shielded connection terminals (3) (available as an accessory). These hook into the bottom shielding plate and guarantee optimum contact between the shield and the shielding plate.

6.4 Digital inputs

Connector pin assignment

Connector X30	Pin	Designation	Description	
	1	SS1 Activate	Activate safety function SS1	
	2	SS2 Activate	Activate safety function SS2	
	3	SOS Activate	Activate safety function SOS	
	4	SLS Activate	Activate safety function SLS	
	12	SSR Activate	Activate safety function SSR	
	13	SDI Neg Activate	Activate safety function SDI (anti-clockwise)	
	14	SDI Pos Activate	Activate safety function SDI (clockwise)	
	15	SBT Activate	Activate safety function SBT	
	20	SS1 SIL3/Reset	Input for SIL3 and reset	

Connection

Input circuit	Digital input
	<p>Shielded cable</p> <p>Max. cable length: 30 m</p> <p>24 VDC</p> <p>Referenced to earth: X30, Pin 21, 22 are linked internally</p>

6.5 Digital outputs

6.5.1 Supply voltage

The digital outputs need a 24 VDC supply.

- ▶ When selecting the power supply, please refer to the requirements stated under “Technical Details”.
- ▶ The power supply must be able to bridge a power outage of 20 ms.



WARNING!
Electric shock!

Safe electrical isolation must be ensured for the external power supply that generates the supply voltage. Failure to do so could result in electric shock. The power supplies must comply with EN 60950-1, 05/2006, EN 61558-2-6, 11/1997.

Connector pin assignment

Connector X30	Pin	Name	Description
	10	24 V Supply	Supply voltage for digital outputs (24 V)
	21, 22	0 V Supply	Supply voltage for digital outputs (0 V)
	Pins 21 and 22 are linked internally		

6.5 Digital outputs

Connection

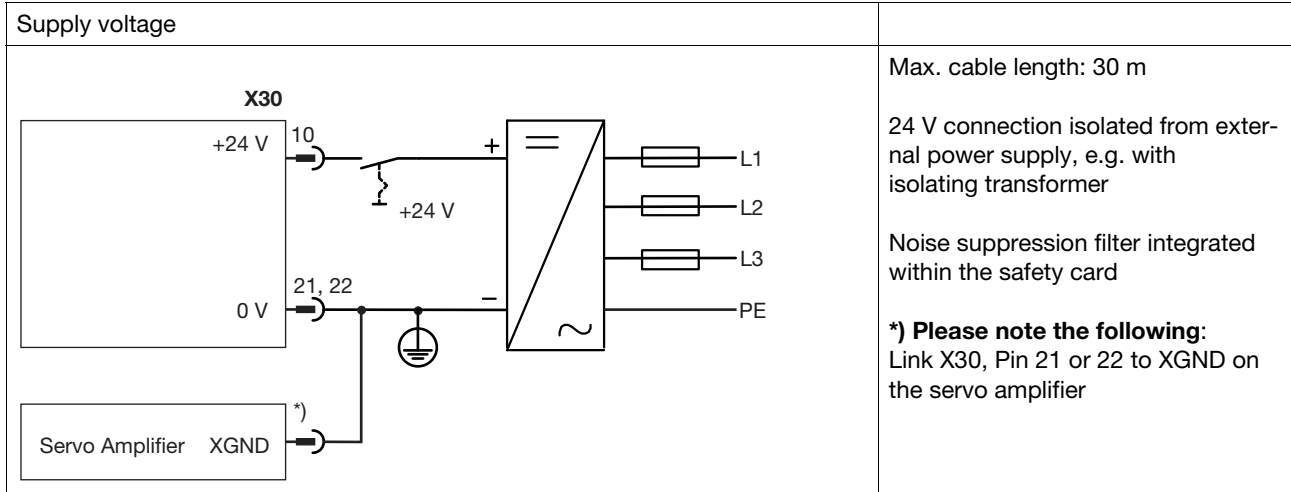

- *) XGND:
- ▶ S701 ... S724:
X4A, Pin 2
 - ▶ S748, S772:
X4, Pin 3

6.5.2 Single-pole outputs

Connector pin assignment

Connector X30	Pin	Name	Description
	5	STO Acknowledge	Status: STO activated
	6	SOS Acknowledge	Status: SOS activated
	7	SDI Acknowledge	Status: SDI activated
	8	SRA Acknowledge	Status: SSR or SLS activated
	9	SBT Acknowledge	Status: Brake test
	10	24 V Supply	Supply voltage for digital outputs (24 V)
	16	Ready	Status: Safety card ready for operation
	19	STO SIL3	Second shutdown route
	21	0 V Supply	Supply voltage for digital outputs (0 V)

6.5 Digital outputs

Connection

Output circuit	Digital output
	Shielded cable Max. cable length: 30 m 24 VDC Referenced to earth: 0V Supply X30 Pin 21,22

Connection

Output circuit	Digital output
	24 VDC Referenced to earth: 0V Supply

- *) XGND:
- ▶ S701 ... S724:
X4A, Pin 2
 - ▶ S748, S772:
X4, Pin 3

- ***) STO2-ENABLE:
- ▶ S701 ... S724:
X4A, Pin 3
 - ▶ S748, S772:
X4, Pin 5



INFORMATION

If the "STO SIL3" output is not used, 24 VDC must be applied to the "STO2-ENABLE" input on the servo amplifier.

6.5 Digital outputs

6.5.3 Dual-pole outputs

Connector pin assignment

Connector X30	Pin	Designation	Description
<p>X30</p>	17	SBC+	Output: Control external brake +
	18	SBC-	Output: Control external brake -
	12		
	13		
	14		
	15		
	16		
	18		
	19		
	20		
	21		
22			

Connection

External mechanical brake	Digital output
	<p>Shielded cable</p> <p>Max. cable length: 30 m</p> <p>Brake's supply voltage: 24 VDC, tolerance 0 ... 15%</p> <p>*) Please note the following: Link X30, Pin 21 or 22 to XGND on the servo amplifier</p>

- *) XGND:
- ▶ S701 ... S724:
X4A, Pin 2
 - ▶ S748, S772:
X4, Pin 3

6.6 Encoder

6.6.1 Supply voltage



WARNING!
Electric shock!

Safe electrical isolation must be ensured for the external power supply that generates the supply voltage. Failure to do so could result in electric shock. The power supplies must comply with EN 60950-1, 05/2006, EN 61558-2-6, 11/1997.

Connector pin assignment

Connector X30	Pin	Name	Description
<p>X30</p>	11	Encoder Supply	Supply voltage for external encoder
	22	0 V Encoder Supply	Supply voltage for external encoder (0 V)

Connection

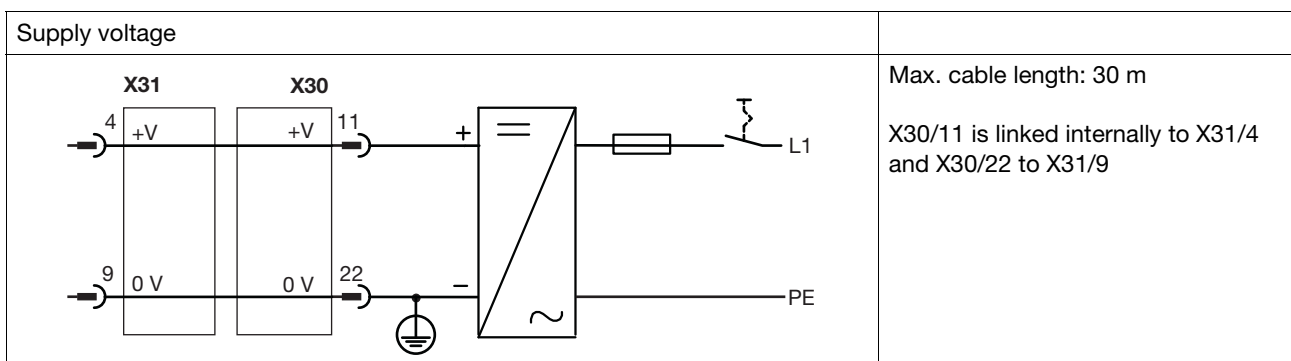

INFORMATION

When using the safety card with the servo amplifier S772: Connect a ferrite core (Würth, No. 7427111) before the terminals X30/11, 22 across the lines +V and 0 V.

6.6 Encoder

6.6.2 Incremental encoder with TTL signal

If the cable length is > 50 m, please speak to our Customer Support.

Connector pin assignment

Connector X31	Pin	Name	Description
	1	A	Channel A
	2	B	Channel B
	3	Z	Reference pulse Z
	4	V+	Supply voltage
	5	n.c.	---
	6	A\	Channel A inverted
	7	B\	Channel B inverted
	8	Z\	Reference pulse Z inverted
	9	0 V	Supply voltage 0 V

Connection

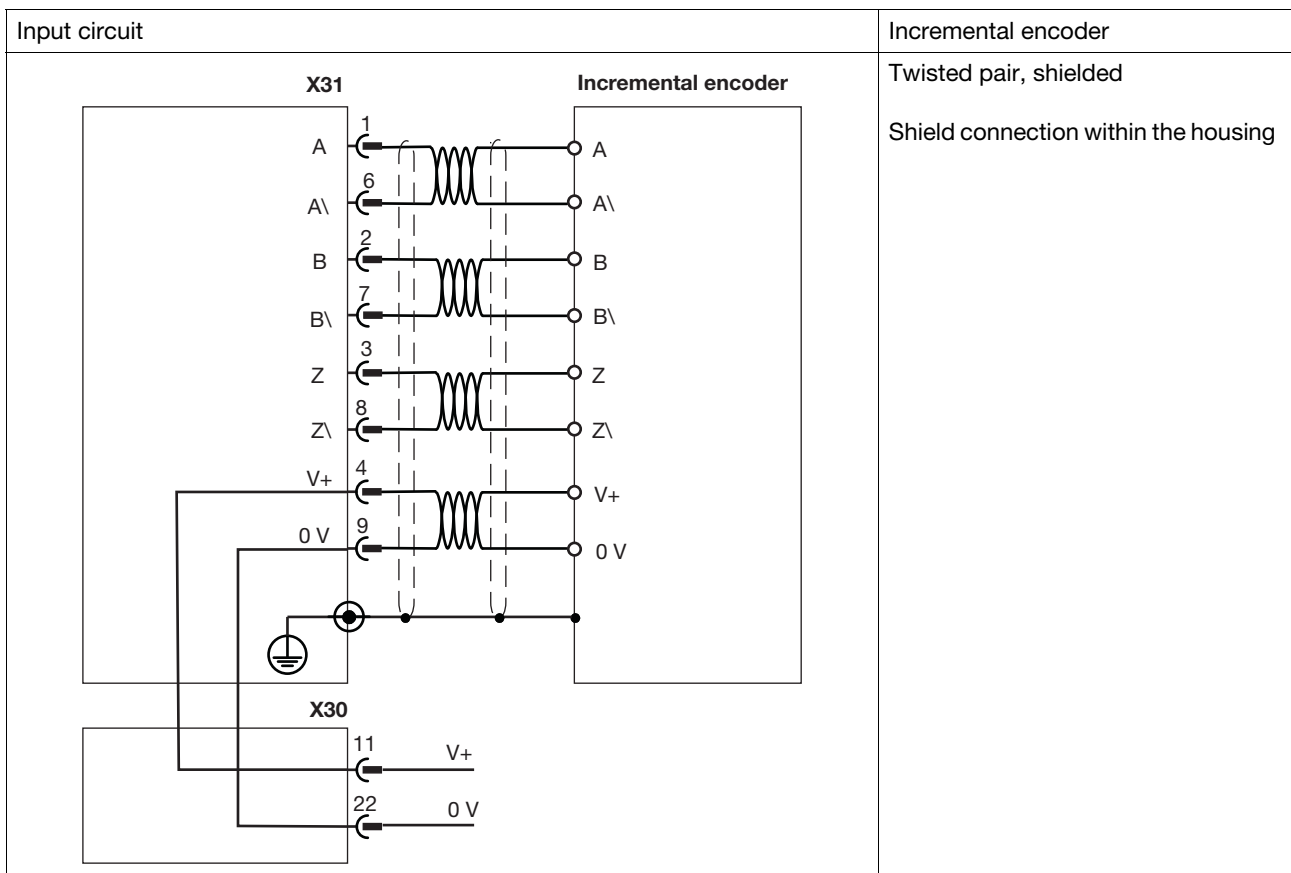

7.1 Safety guidelines

When commissioning/recommissioning, please note the following:

- ▶ Secure the site in accordance with the regulations (barrier, warning signs etc.). The system may only be commissioned/recommissioned by qualified personnel.
- ▶ Please refer to the information and specifications stated in the instruction manual of the relevant programmable control system.
- ▶ During commissioning/recommissioning, make sure that no personal injury and/or material damage can occur, even if the plant/machine moves unintentionally.
- ▶ When commissioning the safety card, please read the safety guidelines in the "Commissioning" chapter in the instructions for the servo amplifier.



DANGER!

Risk of electrocution!

Never wire the electrical connections on the servo amplifier while voltage is applied.

Switch off the mains voltages and 24 V supply!

Make sure that the control cabinet is made safe, e.g. through an access lock or warning signs. Do not switch on the voltages until the system is commissioned!



WARNING!

Threat to life from the motor starting up automatically!

The motor can be set in motion immediately if the option to "Set software enable when booting [AENA]" is set in the commissioning software DriveGUI:

- ▶ After the safety card has run up
- ▶ When recommissioning after an error

Take appropriate measures to ensure that no hazardous situations arise due to the motor starting up.

7.2 Initial commissioning

1. Preparing for commissioning

- ▶ The safety card has been properly configured in the Configurator. Please ensure that you only configure the safety functions that are actually wired up to the safety card inputs.



INFORMATION

When configuring the safety card, please refer to the Configurator's online help.

- ▶ The safety card is installed on the servo amplifier (See "Installation" chapter).
- ▶ The device number (serial number and order number) of the safety card on the servo amplifier matches the device number of the safety card in the Configurator.
- ▶ The servo amplifier is ready for commissioning (see instruction manual for the servo amplifier).

2. Wire up the safety card



INFORMATION

Please note the guidelines given under "Wiring".

- ▶ Connect the 24 VDC supply voltage ("+" to X30/10, "-" to X30/21)



INFORMATION

Do not switch on the supply voltage at this point.

- ▶ Wire up the inputs and outputs that have been configured. Please note that the inputs "SS1 Activate" and "Reset" must always be connected.

3. Connect the configuration PC to the servo amplifier or motion control system

- ▶ Connect the PC to the servo amplifier or motion control system (RS 232 or Ethernet).
- ▶ Set the interface in the Configurator (see the Configurator's online help).

7.2 Initial commissioning

4. Switch on the supply voltages

- ▶ Switch on all the supply voltages for the servo amplifier and safety card.

You will know when the servo amplifier and safety card are ready for operation by the display elements on the individual components. The display elements on the safety card are described in this manual, under "Operation".



INFORMATION

Up to twenty seconds may elapse before the safety card is ready for operation.

5. Download configuration file

- ▶ Establish communication between the PC and servo amplifier:
Select **Download Project** in the Configurator.
 - Make sure that no other system is accessing the interface.
 - To perform the download you will need to enter the safety cards' order and serial numbers for identification purposes.
 - On multi-axis systems the safety cards can be selected individually for the download. The configuration is distributed to the safety cards via the motion control system.

The configuration file is downloaded. The "CONFIG" LED flashes.

The configuration is checked as it is downloaded:

- ▶ Feasibility of the configuration data
- ▶ Proper wiring
- ▶ Correct device number (order number and serial number)

If the self test is successful, the servo amplifier's power element is enabled. The "Ready" output has a "1" signal. The "RUN" LED is lit.

7.2 Initial commissioning

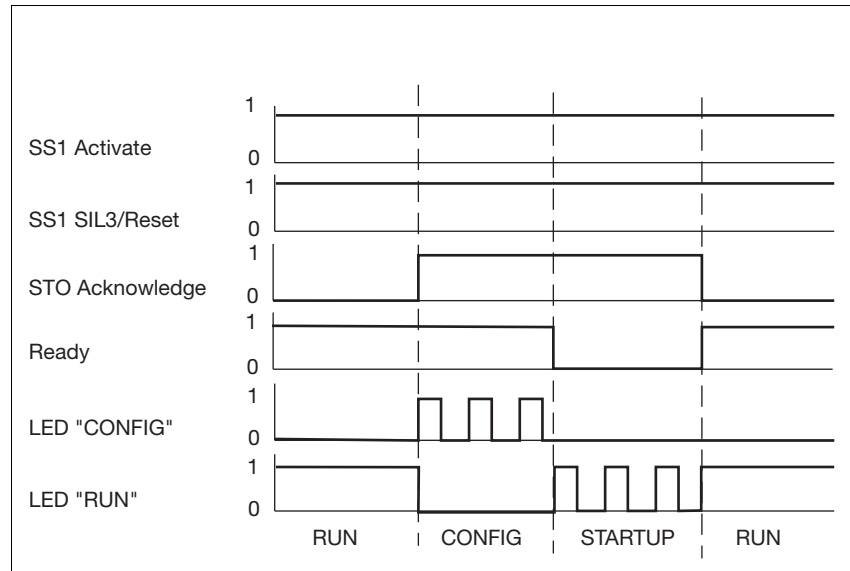

- ▶ SS1 Activate: Input for safety function SS1
- ▶ SS1 SIL3/Reset: Input for SIL3 and reset
- ▶ STO Acknowledge: Output for feedback from safety function STO
- ▶ Ready: Output for operating status of the safety card
- ▶ "CONFIG" LED: Configuration data is downloaded
- ▶ "RUN" LED: System is ready
- ▶ RUN: System is ready for operation
- ▶ CONFIG: Downloading the configuration data
- ▶ STARTUP: System starts up with the downloaded configuration

The inputs and outputs on the safety card can be tested using

- ▶ The dynamic program display in the safety card's Configurator

7.3 Recommissioning

7.3.1 Recommissioning at a restart

The timing diagram below illustrates the signal sequence of the servo amplifier and safety card at a restart. The safety card has already been configured (see "Initial commissioning")

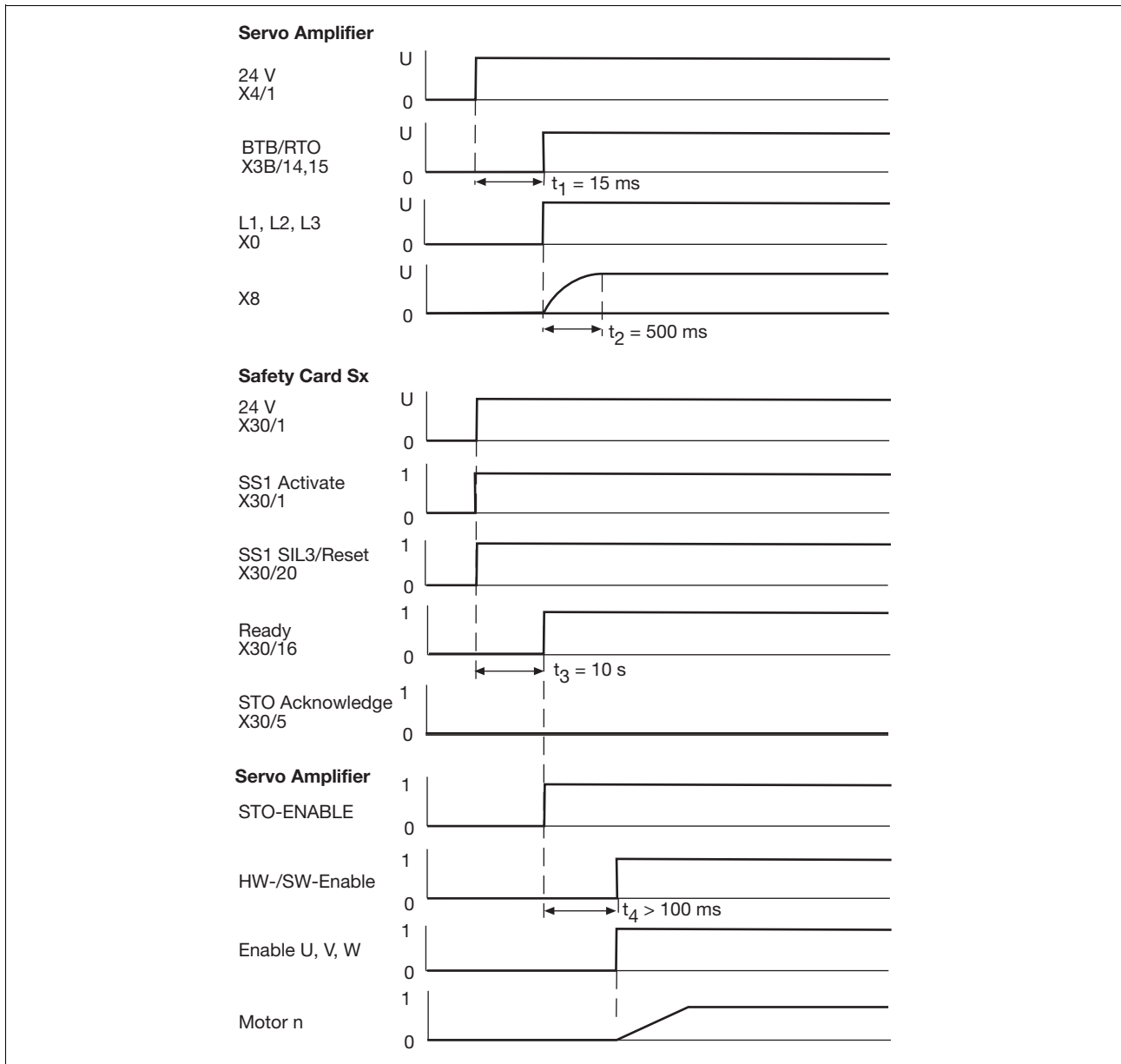

7.3 Recommissioning

Key:

- ▶ Servo amplifiers
 - 24 V: Supply voltage
 - BTB/RTO: Relay contact for operational readiness, servo amplifier
 - L1, L2, L3: Mains voltage
 - X8: Intermediate circuit
 - STO-ENABLE: Start interlock
 - HW-/SW-Enable: Hardware and software enable
 - Enable U, V, W: Motor connection
 - Motor n: Motor speed
 - t_1 : Servo amplifier's run-up time
 - t_2 : Load time, intermediate circuit capacitance
 - t_4 : Processing time until servo amplifier is enabled
- ▶ Safety card
 - 24 V: Supply voltage
 - SS1 Activate: SS1 activated
 - SS1 SIL3/Reset: Input for SIL3 and reset
 - Ready: Operational readiness
 - STO Acknowledge: Status: STO activated
 - t_3 : Safety card's run-up time

7.3.2 Recommissioning after error

This section describes the recommissioning process after an error has occurred.

Rectify the error, noting:

- ▶ The error messages in the error stack
- ▶ The LED display.

Perform a reset as follows:

- ▶ Switch inputs SS1 Activate or SS1 SIL3/Reset
 - or
- ▶ Run the command "CLRFAULT"

7.3.2.1 Switching the inputs "SS1 Activate" or "SS1 SIL3/Reset"

1. Switch input SS1 Activate or SS1 SIL3/Reset to 0 V
 - ▶ The safety card performs the safety function SS1 (Safe Stop 1) and switches to a "STOP" condition. The "FAULT" LED is flashing.

7.3 Recommissioning

2. Switch input SS1 Activate or SS1 SIL3/Reset to 24 V.

- ▶ The safety card switches to a "STARTUP" condition. The device and the safe pulse disabler are tested. The "RUN" LED flashes.
- ▶ The safety card switches to a "RUN" condition. The "RUN" LED is lit continuously.

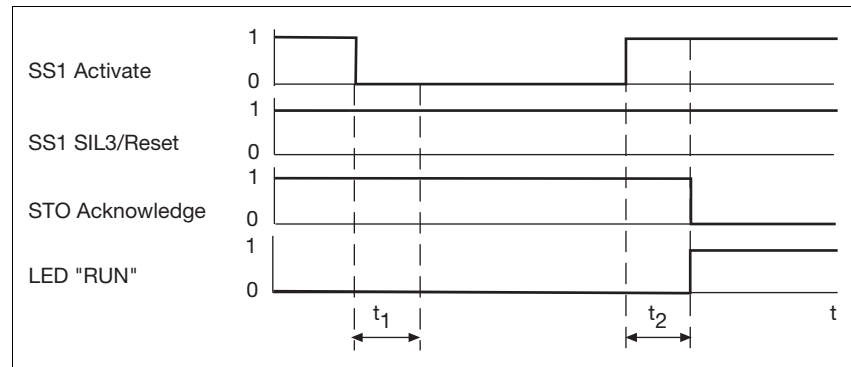

- ▶ t_1 : At least 2 ms; time during which SS1 Activate or SS1 SIL3/Reset must have a "0" signal
- ▶ t_2 : approx. 2 s, safety card's run-up time
- ▶ SS1 Activate: Input for safety function SS1
- ▶ SS1 SIL3/Reset: Input for SIL 3 and reset
- ▶ STO Acknowledge: Output for feedback from safety function STO
- ▶ "RUN" LED: System is ready

7.3.2.2 Command "CLRFAULT"

The safety card can be reset using the "CLRFAULT" command via the serial interface or fieldbus interface on the servo amplifier.

Prerequisites for using the "CLRFAULT" command

- ▶ The safety card is in "STOP" condition. The "FAULT" LED is flashing.
- ▶ Both inputs SS1 Activate and SS1 SIL3/Reset have a "1" signal (24V).

Alternatively this function can also be assigned to a digital input on the servo amplifier. Two commands are available:

- ▶ The command IN1MODE=1, (servo amplifier error reset), activates the function on digital input DIGITAL-IN1 of the servo amplifier.
- ▶ The commands INxMODE=30 or INxMODE=33 (run any command string) activate the function on one of the digital inputs on the servo amplifier (e.g. IN4MODE=30 on input DIGITAL-IN4).

7.3 Recommissioning



INFORMATION

Further information on the command can be found in the servo amplifier's online help.



INFORMATION

Availability of this function: From firmware version 5.24 of the servo amplifier.

7.3.3 Swap safety card

When swapping the safety card, please note the following:

- ▶ If the firmware version has changed, configured functions and stated parameters may no longer be supported or may have been modified. Adapt the configuration in the SafetyGUI software.
- ▶ You will need to download the configuration to the safety card again. Please note down the serial number of the new safety card.
- ▶ We recommend that you swap the whole unit (servo amplifier with safety card). Please contact Kollmorgen's customer services.



CAUTION!

Damage due to electrostatic discharge!

Electrostatic discharge can damage components. Ensure against discharge before touching the product, e.g. by touching an earthed, conductive surface or by wearing an earthed arm-band.

After swapping the safety card, following a defect for example, you will need to download the configuration data to the safety card again.

You can download the configuration data to the safety card as follows:

- ▶ ① From the Configurator to the safety card via the servo amplifier's communications interface (RS 232 or Ethernet).
- ▶ ④ From an SD card in the servo amplifier to the safety card.

7.3 Recommissioning

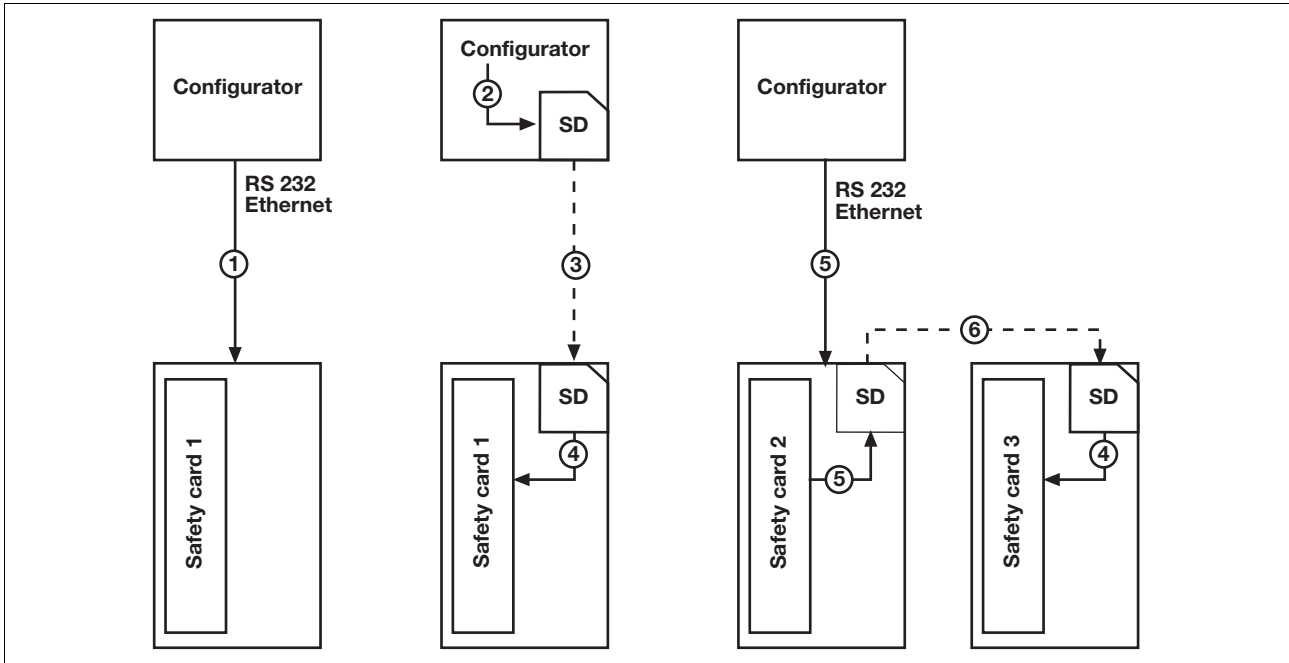

Fig. 7-1: Download configuration

Key:

- ① Downloading a configuration from the Configurator directly to safety card 1
- ② Downloading a configuration via an SD card, which is written by the PC
- ③ Inserting an SD card into the read device of the servo amplifier for safety card 1
- ④ Downloading a configuration to the safety card from an SD card in the servo amplifier
- ⑤ Downloading a configuration via an SD card, which is written by the servo amplifier (safety card 2)
- ⑥ Inserting an SD card from the servo amplifier for safety card 2 into the read device of the servo amplifier for safety card 3

7.3 Recommissioning

7.3.3.1 Download configuration from Configurator to safety card

① The configuration data on the safety card can be downloaded directly from the Configurator to the safety card in the servo amplifier.

Prerequisite:

- ▶ Connection is established between the PC and servo amplifier (RS 232 or Ethernet).

Procedure:

⇒ Select **Online Mode -> Download Project** in the safety card's Configurator.



INFORMATION

Further information is available in the safety card Configurator's online help.

7.3.3.2 Download configuration to SD card

②⑤ You can download the configuration data to the safety card via an SD card. The configuration data must first be saved to the SD card.

There are two options for downloading a configuration to an SD card:

1. option ②: Downloading a configuration via an SD card, which is written by the PC.

Prerequisite:

- Connection to an external SD card read device

Procedure:

⇒ Select **Project -> Save to SD Card** in the safety card's Configurator.

⇒ Remove the SD card from the external SD card read device and insert it into the servo amplifier's SD card read device ③ (continue as described under "Download configuration from SD card to safety card").

2. option ⑤: Downloading a configuration via an SD card, which is written by the servo amplifier.

Prerequisite

- Connection is established between the PC and servo amplifier (RS 232 or Ethernet).
- An SD card must be inserted in the servo amplifier.

7.3 Recommissioning

Procedure:

- ⇒ Select **Online Mode -> Servo Amplifier Configuration -> SD Card** in the safety card's Configurator.
- ⇒ Remove the SD card from the servo amplifier and insert it into the SD card read device of the servo amplifier that you wish to configure ⑥ (continue as described under "Download configuration from SD card to safety card").



INFORMATION

Further information is available in the safety card Configurator's online help.

7.3.3.3 Download configuration from SD card to safety card

Before carrying out the steps described in this section, please note the following safety guidelines:



CAUTION!

Make absolutely sure that the SD card with the safety card configuration is inserted into the read device of the correct servo amplifier. If not, invalid parameter settings (e.g. limit values) may lead to unexpected movements and hazardous situations for either people or equipment.

When the configuration is downloaded from the SD card, the servo amplifier does not check the safety card configuration, nor does it check that the configuration is assigned correctly to a specific safety card.

After swapping the safety card, check that the safety functions are activated correctly.

- ④ The safety card's configuration data can be downloaded to the safety card from an SD card inserted in the servo amplifier, without using the Configurator.

During this process, the firmware for the servo amplifier is also reloaded.



7.3 Recommissioning



Prerequisite:

- ▶ The following files must be available on the SD card (③ or ⑥):
 - default.pdis: Configuration file for the safety card
 - default.bin or default.s19: Firmware for the servo amplifier
 - default.par: Parameter file for the servo amplifier

Procedure:

1. **Switch off the 24 V supply to the servo amplifier.**
2. **Insert the SD card into the read device in the servo amplifier.**

3. **Keep both operator keys   on the servo amplifier pressed down.**
4. **Switch on the 24 V supply to the servo amplifier.**
5. **Release the keys when "-" appears on the display.**

6. **Press both operator keys   again and then release them.**
 - The firmware update for the servo amplifier is started.
 - The file default.bin or default.s19 is loaded.
 - Display: Counts from 0 to 100, stops at 100 and then counts from 100 to 0.
 - The servo amplifier is restarted. The parameter file default.par is loaded.
 - The safety card is restarted: The "CONFIG" LED flashes.
7. **Wait until "dis" (= drive integrated safety) appears on the display.**
 - Note: You must then press the left-hand operator key on the servo amplifier within 60 seconds (see step 8).

8. **Press the left-hand operator key  for at least 2 seconds.**
 - The configuration file default.pdis starts downloading to the safety card. Display: "...".
 - Once the configuration file has been downloaded, the safety card starts up. The safety card is in "STARTUP" condition ("RUN" LED flashes).
 - If the download has been successful, the safety card switches to "RUN" condition ("RUN" LED is lit).

7.4 Safety checks

The machine manufacturer must check and verify the functionality of the employed safety functions.

- ▶ The safety functions may only be checked by qualified personnel.

The safety function must be checked

- ▶ After initial commissioning
- ▶ After changing the configuration of the safety functions
- ▶ After exchanging the safety card or servo amplifier

A full check comprises

- ▶ Proper execution of the employed safety functions
- ▶ Inspection of the parameters

The result of the check on each safety function must be documented in a test report. This test report must be signed.



INFORMATION

If any of the parameters for the safety functions have been changed, the check must be repeated and this must be recorded in the test report.

Regular checks

Check the safety functions at regular intervals. The aim of these regular checks is to uncover any changes to the plant/machine, safety functions and ambient conditions.

You must comply with the requirements of the applicable national regulations.

The intervals you select will depend on the application, the overall system and the associated risk analysis. The test interval should not exceed one year.

Brake test

Depending on the application, the regular checks may include a test of the internal (motor brake) and external brake.



INFORMATION

Please refer to "Safe brake test - SBT" for details of the function of the safe brake test.

Prerequisites for normal operation are:

- ▶ Commissioning is complete
- ▶ The safety card contains the configuration data
- ▶ The safety functions have been tested
- ▶ The "RUN" LED is lit

During operation

- ▶ Any pulse edge change at the safety card's safe inputs is monitored
- ▶ The safety functions are performed in accordance with the configuration.

8.1 Operating states

The safety card is always in clearly defined operating states.

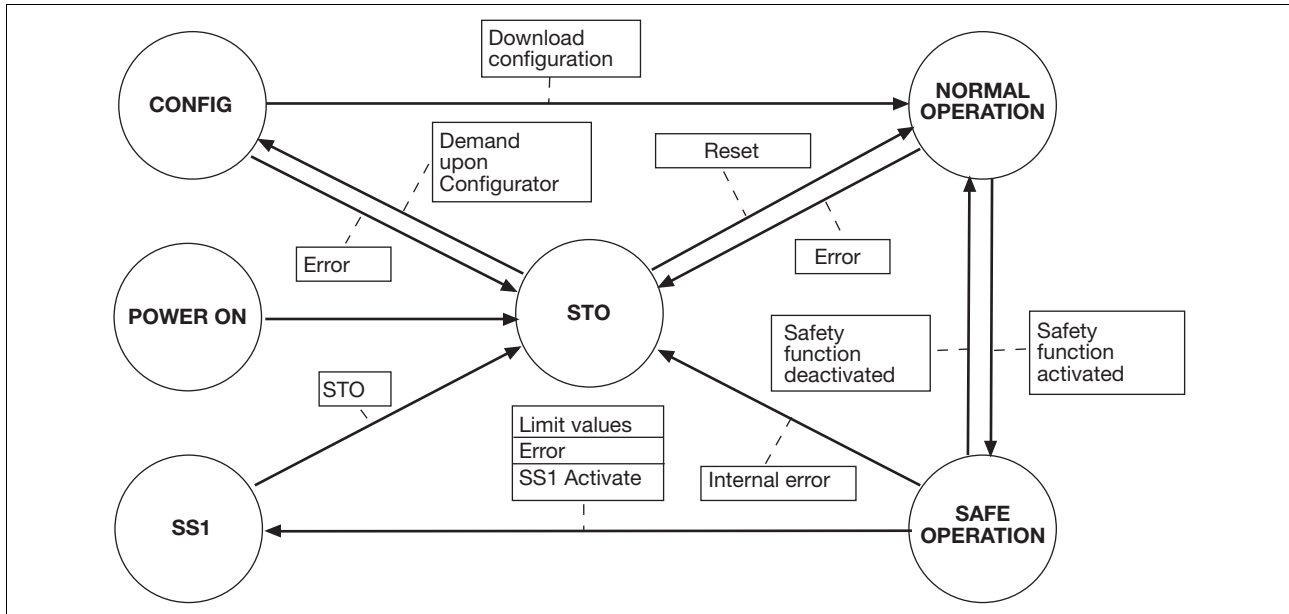

POWER ON

- ▶ The supply voltages are present.
- ▶ Transition to STO once the supply voltages are applied

CONFIG

- ▶ Download of configuration to the safety card
- ▶ Transition to NORMAL OPERATION: Configuration downloaded without error
- ▶ Transition to STO: Incorrect configuration data

NORMAL OPERATION

- ▶ No safety function activated
- ▶ Transition to STO: Internal error
- ▶ Transition to SAFE OPERATION: A safety function is activated

SAFE OPERATION

- ▶ Safe operation after at least one safety function has been activated
- ▶ Transition to STO: Internal error
- ▶ Transition to SS1 due to
 - Error
 - Violation of limit values
 - Demand upon safety function SS1
- ▶ Transition to NORMAL OPERATION: No safety function activated

8.1 Operating states

SS1

- ▶ SS1 is activated
 - After violation of the limit values
 - After an error
 - After a demand upon safety function SS1
- ▶ Transition to STO: After activation of SS1 (drive is brought to a standstill with a defined braking ramp)

STO

- ▶ There is no power to the motor after execution of safety function STO
- ▶ Transition to CONFIG: Demand upon the Configurator
- ▶ Transition to NORMAL OPERATION due to
 - Reset of safety card (see "Recommissioning")
 - Prior POWER ON

8.2 Testing the safe pulse disabler

The safety card meets the requirements of EN IEC 61508 up to SIL 3 and EN ISO 13849-1 up to PL e.

To achieve category SIL 3 or PL e, the operator must ensure that the function of the safe pulse disabler is tested periodically, after 8 hours at the latest, by triggering safety functions SS1 or STO:

- ▶ By restarting after safety functions SS1 or STO have been triggered as a condition of operation
or
- ▶ By restarting after safety function SS1 has been triggered by the operator

To test the safe pulse disabler, proceed as follows:

1. Switch input SS1 Activate or SS1 SIL3/Reset to 0 V
 - ▶ The safety card performs the safety function SS1 (Safe Stop 1) and switches to a "STOP" condition. The "FAULT" LED is flashing.
2. Switch input SS1 Activate or SS1 SIL3/Reset to 24 V.
 - ▶ The safety card switches to a "STARTUP" condition. The device and the safe pulse disabler are tested. The "RUN" LED flashes.
 - ▶ The safety card switches to a "RUN" condition. The "RUN" LED is lit continuously.

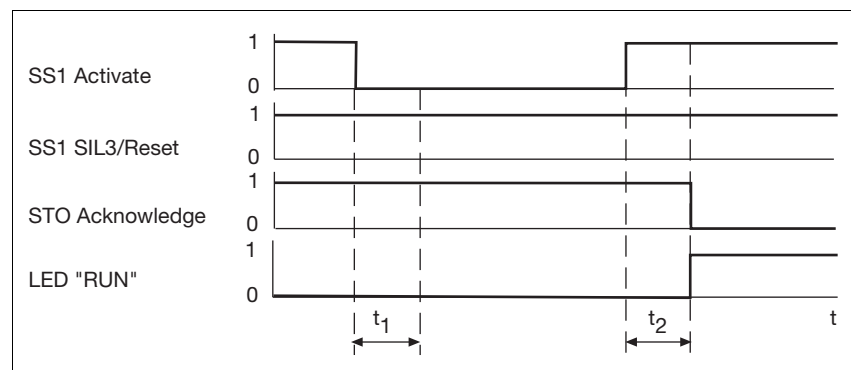

- ▶ t_1 : At least 2 ms; time during which SS1 Activate or SS1 SIL3/Reset must have a "0" signal
- ▶ t_2 : approx. 2 s, safety card's run-up time
- ▶ SS1 Activate: Input for safety function SS1
- ▶ SS1 SIL3/Reset: Input for SIL 3 and reset
- ▶ STO Acknowledge: Output for feedback from safety function STO
- ▶ "RUN" LED: System is ready

8.3 Display elements

The expansion card has LEDs to display the status of the operating states.

	LED			Meaning
	Name	Colour	Status	
	POWER	---	●	Supply voltage is not present
		Green		Supply voltage is present
	RUN	---	●	System not ready
		Green		System read ("RUN" status)
		Green		System boots ("Startup" status)
	CONFIG	---	●	Normal operation
		Yellow		Downloading the configuration data
	FAULT	---	●	No error
		Red		Error ("STOP" status)

► Legend

	LED on
●	LED off
	LED flashes

8.4 Messages

Any errors on the safety card are indicated on the servo amplifier display with message "F31".

The following options are available for detailed diagnostics and fault detection:

- ▶ LEDs on the front of the safety card provide information on operating states (see section on "Display elements" in this chapter).
- ▶ Outputs on the safety card display the status of the safety functions (e.g. SS1 Acknowledge).
- ▶ Errors and messages are entered in the safety card's error stack.
- ▶ The following are displayed in online mode in the Configurator SafetyGUI:
 - Safety card status and error messages (error stack)
 - Status of safety card inputs and outputs

9.1 Technical Details

Technical details	Safety Card S1
Application range	Failsafe
Electrical data	
Supply voltage U_B DC	24.0 V
Voltage tolerance	-15 %/+20 %
Inputs	
Number	9
Input voltage in accordance with EN 61131-2 type 1	24 V DC
Input current range	3.5 - 10.8 mA
Signal level at "1"	15 - 30 V DC
Signal level at "0"	-3 - +5 V DC
Pulse suppression	0.6 ms
Galvanic isolation	yes
Outputs, single-pole	
Number of positive-switching single-pole semiconductor outputs	7
Short circuit-proof	yes
Typ. output current at "1" signal and rated voltage of semiconductor output	0.50 A
Monitoring threshold of semiconductor output	7.0 V
Permitted current range	0.50 A
Residual current at "0" signal	0.02 mA
Max. duration of on time during self test	200 μs
Max. duration of off time during self test	200 μs
Permitted loads	inductive, capacitive, resistive
Outputs, dual-pole	
Number of dual-pole semiconductor outputs	1
Short circuit-proof	yes
Galvanic isolation	yes
Typ. output current at "1" signal and rated voltage of semiconductor output	2.0 A
Monitoring threshold of semiconductor output	7.0 V
Permitted current range	2.00 A
Residual current at "0" signal	0.50 mA
Max. duration of on time during self test	200 μs
Max. duration of off time during self test	200 μs
Permitted loads	inductive, capacitive, resistive
Times	
Response time	4 ms
Error reaction time	2 ms
Encoder input	
Number of inputs	1
Connection type	Female 9-pin D-SUB connector SSI encoder Incremental encoder

9.1 Technical Details

Encoder input	
SSI encoder	
Voltage range	10 ... 30 VDC, 4.75 ... 5.25 VDC
Output signal (clock)	Differential signal (RS 422)
Max. number of bits on the counter input	12 - 25 Bit
Selectable transmission rates	1,000.0 kHz
Coding of the input signal	Binary, Grey
Signal at the data input	Differential signal (RS 422)
Incremental encoder	
Voltage range	10 ... 30 VDC, 4.75 ... 5.25 VDC
Signal level at "1"	>= 2.5 V
Signal level at "0"	<= 0.5 V
Phase position for the differential signals A _A and B _B	90° ±30°
Input resistance	0.3 kOhm
Maximum threshold frequency	0.5 MHz
Environmental data	
Climatic suitability	EN 60068-2-14, EN 60068-2-1, EN 60068-2-2, EN 60068-2-30, EN 60068-2-78
Ambient temperature in accordance with DIN EN 60721-3-3	0 - 40 °C
Storage temperature in accordance with DIN EN 60721-3-1	-25 - 55 °C
Climatic suitability in accordance with DIN EN 60721-3-3	85 % r. h. at 40 °C
Condensation	Not permitted
EMC	EN 61800-3
Vibration to	IEC 721-3-3
Protection type in accordance with EN 60529	
Mounting (e.g. cabinet)	IP54
Housing	IP20
Terminals	IP20
Airgap creepage in accordance with EN 61800-5-1	
Overvoltage category	II
Pollution degree	2
Mechanical data	
Housing material	
Front	Steel 1,4016
Top	Polyesterfoil
Dimensions	
Height	142.0 mm
Width	18.5 mm
Depth	103.0 mm
Weight	150 g

The standards current on **2009-03** apply.

9.2 Safety characteristic data

9.2.1 Safe actuator with one encoder

9.2.1.1 MTTF >= 10 years

Safety characteristic data						
Device	Operating mode	EN ISO 13849-1 PL	EN 954-1 Category	EN IEC 62061 SIL CL	PFH [1/h]	t _M [year]
Safety card						
	Safe actuator with motor encoder, MTTF of motor encoder ≥ 10 years	PL d (Cat. 3)	Cat. 3	SIL CL 2	1.26E-07	20

This operating mode requires a motor encoder with MTTF ≥ 10 years.

The motor encoder is already included in the characteristic data, so no more calculations need to be performed for the "Safe Actuator" subsystem.

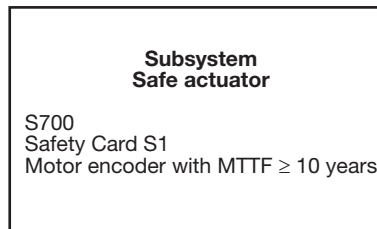

The safety-related characteristic data is valid for all safety functions.

All the units used within a safety function must be considered when calculating the safety characteristic data.

9.2.1.2 MTTF >= 57 years

Safety characteristic data						
Device	Operating mode	EN ISO 13849-1 PL	EN 954-1 Category	EN IEC 62061 SIL CL	PFH [1/h]	t _M [year]
Safety card						
	Safe actuator with motor encoder, MTTF of motor encoder ≥ 57 years	PL e (Cat. 4)	Cat. 4	SIL CL 3	2.37E-08	20

9.2 Safety characteristic data

The characteristic data is valid when using a motor encoder with an $MTTF \geq 57$ years.

The motor encoder is already included in the characteristic data, so no more calculations need to be performed for the "Safe Actuator" subsystem.

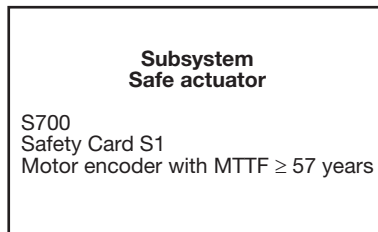

The safety-related characteristic data is valid for all safety functions.

All the units used within a safety function must be considered when calculating the safety characteristic data.

9.2.2 Safe actuator with two encoders

Safety characteristic data						
Device	Operating mode	EN ISO 13849-1 PL	EN 954-1 Category	EN IEC 62061 SIL CL	PFH [1/h]	t_M [year]
Safety card						
	Safe actuator	PL e (Cat. 4)	Cat. 4	SIL CL 3	1.19E-08	20

The safety analysis of the plant or machine may necessitate a second encoder (external encoder).

The sensor subsystem consists of the motor encoder (sensor 1) and an external encoder (sensor 2). A separate PL or SIL must be calculated for this subsystem. For this subsystem structure, Category 3 with a DC of 99 % is acceptable. The following characteristic data is required for both sensors (motor encoder and external encoder): $MTTF_d$ and λ_d / λ .

9.2 Safety characteristic data



The safety-related characteristic data is valid for all safety functions.

All the units used within a safety function must be considered when calculating the safety characteristic data.

SBC - Safe brake control	Safety function in accordance with EN 61800-5-2, supplies a safe output signal to drive an external brake. SBC is the abbreviation for safe brake control.
SBT - Safe brake test	Safety function which tests an external holding brake and the motor brake. SBT is the abbreviation for safe brake test.
SDI - Safe direction	Safety function in accordance with EN 61800-5-2, monitors the drive's direction of rotation. SDI is the abbreviation for safe direction.
SLS - Safely limited speed	Safety function in accordance with EN 61800-5-2, monitors the drive to check that it stays within a defined speed limit. SLS is the abbreviation for safely limited speed.
SOS - Safe operating stop	Safety function in accordance with EN 61800-5-2, monitors the stop position that has been reached and keeps this position within a defined range. SOS is the abbreviation for safe operating stop
SS1 - Safe stop 1	Safety function in accordance with EN 61800-5-2, brakes the motor in a controlled manner and removes the power to the motor. SS1 is the abbreviation for safe stop 1.
SS2 - Safe stop 2	Safety function in accordance with EN 61800-5-2, brakes the drive in a controlled manner and then initiates safe standstill monitoring. SS2 is the abbreviation for safe stop 2.
SSR - Safe speed range	Safety function in accordance with EN 61800-5-2, monitors the drive's current speed to ensure it stays within a maximum permitted limit value. SSR is the abbreviation for safe speed range.
STO - Safe torque off	Safety function in accordance with EN 61800-5-2, removes the power to the motor and switches it to torque-free. STO is the abbreviation for safe torque off.



► ...
In many countries we are represented by our subsidiaries and sales partners.

Please refer to our homepage for further details or contact our headquarters.

Pilz GmbH & Co. KG
Felix-Wankel-Straße 2
73760 Ostfildern, Germany
Telephone: +49 711 3409-0
Telefax: +49 711 3409-133
E-Mail: pilz.gmbh@pilz.de
Internet: www.pilz.com

► Technical support

+49 711 3409-444
support@pilz.com

pilz

InduraneT p[®], Pilz[®], PIT[®], PMCprotego[®], PMI[®], PNOZ[®], Primo[®], PSEN[®], PSS[®], PVIS[®], SafetyBUS P[®], SafetyEYE[®], SafetyNET p[®], the spirit of safety[®] are registered and protected trademarks of Pilz GmbH & Co. KG in some countries. We would point out that product features may vary from the details stated in this document, depending on the status at the time of publication and the scope of the equipment. We accept no responsibility for the validity, accuracy and entirety of the text and graphics presented in this information. Please contact our Technical Support if you have any questions.