



PROFIBUS S300/S400/S600/S700

Communication Profile

Fieldbus Interface

Translation of the original manual.

Edition 12/2010

Keep the manual as a product component during the life span of the product. Pass the manual to future users / owners of the product.

Datei srprof_e.***

KOLLMORGEN

Previous editions

Edition	Comments
05 / 1999	Preliminary version
10 / 1999	First edition
06 / 2002	new layout, several corrections, valid from firmware 3.54
11 / 2005	Valid for the S300/S400/S600 series, several corrections, company name changed, front- and back-page new design
12 / 2005	Language improvements in the english version
09 / 2006	New Design
08 / 2007	Branding, S700 new, Symbols, Standards
12 / 2008	Several corrections, PNU1785 expanded
07 / 2009	Product branding
12 / 2009	Several minor corrections, Symbols according to ANSI Z535
12 / 2010	Company name new

SINEC is a registered trademark of Siemens AG

SERVOSTAR is a registered trademark of Kollmorgen Corporation

Technical changes to improve the performance of the equipment may be made without prior notice!

Printed in the Federal republic of Germany

All rights reserved. No part of this work may be reproduced in any form (by photocopying, microfilm or any other method) or stored, processed, copied or distributed by electronic means, without the written permission of Kollmorgen Europe GmbH.

1	General	
1.1	About this manual	5
1.2	Target group	5
1.3	Use as directed	6
1.4	Symbols used in this manual	6
1.5	Abbreviations used in this manual	6
2	Installation / Setup	
2.1	Installation	7
2.1.1	Safety notes	7
2.1.2	Inserting the expansion card (S300, S600 and S700)	8
2.1.2.1	Front view	8
2.1.2.2	Setup of Station Address and Baud Rate	8
2.1.2.3	Connection technology	8
2.1.2.4	Connection diagram	9
2.1.3	Profibus master module setup	10
2.1.3.1	Configuration of the master controller (e.g. Siemens S7)	10
2.1.4	Standard function block for data exchange with the servo amplifier	11
2.2	Amplifier setup	11
2.2.1	Guide to setup	11
2.2.2	Important amplifier configuration parameters	12
2.2.3	Setup Software	13
2.2.3.1	Screen page PROFIBUS	13
2.2.3.2	Screen page PROFIBUS instrument control	14
3	Device Profile	
3.1	Parameter channel	16
3.1.1	Parameter ID (PKE)	16
3.1.1.1	Interpretation of the response IDs	16
3.1.1.2	Response ID 7: Profile specific error numbers	17
3.1.2	Index IND	17
3.1.3	Parameter value PWE	18
3.2	The process data channel (PZD)	18
4	Parameter channel (PKW)	
4.1	Read/write an amplifier parameter	19
4.2	Summary of the parameter numbers	19
4.2.1	List of the parameters	20
4.2.2	Standard PROFIDRIVE parameters	22
4.2.2.1	PNU 940/911: PPO type write/read	22
4.2.2.2	PNU 918: PROFIBUS node address	22
4.2.2.3	PNU 963: baud rate	22
4.2.2.4	PNU 965: PROFIDRIVE profile number	22
4.2.2.5	PNU 970: default parameters	22
4.2.2.6	PNU 971: non volatile saving of parameters	22
4.2.2.7	PNU 930: Selection Switch for Operating Mode	23
4.2.3	Manufacturer specific parameters	24
4.2.3.1	PNU 1000: instrument ID	24
4.2.3.2	PNU 1001: manufacturer specific error register	24
4.2.3.3	PNU 1002: manufacturer specific status register	25
4.2.4	Position control parameters	26
4.2.4.1	PNU 1894: velocity multiplier	26
4.2.4.2	PNU 1807: axis type	26

4.2.5	Position data for the position control mode	26
4.2.5.1	PNU 1790: position	26
4.2.5.2	PNU 1791: velocity	26
4.2.5.3	PNU 1785: motion task type	27
4.2.5.4	PNU 1783: acceleration time	27
4.2.5.5	PNU 1784: acceleration jolt limiting	28
4.2.5.6	PNU 1786: deceleration time	28
4.2.5.7	PNU 1787: deceleration jolt limiting	28
4.2.5.8	PNU 1788: next motion task	28
4.2.5.9	PNU 1789: start delay	28
4.2.5.10	PNU 1310: copy motion task	28
4.2.5.11	PNU 1311: position, 32 bit floating decimal point format	28
4.2.5.12	PNU 1312: velocity, 32 bit floating decimal point format	28
4.2.6	Setup mode: position	29
4.2.6.1	PNU 1773: homing type	29
4.2.6.2	PNU 1644: homing direction	29
4.2.7	Actual values	29
4.2.7.1	PNU 1401: speed	29
4.2.7.2	PNU 1402: incremental position, actual value	29
4.2.7.3	PNU 1800: actual position value in SI (User) units	29
4.2.7.4	PNU 1414: actual position, 32 bit floating decimal point format	29
4.2.7.5	PNU 1415: actual velocity, 32 bit floating decimal point format	30
4.2.8	Digital I/O configuration	30
4.2.8.1	PNUs 1698/1701/1704/1707: digital input configuration	30
4.2.8.2	PNUs 1775/1778: digital output configuration	30
4.2.9	Analog configuration	30
4.2.9.1	PNU 1607: analog input configuration	30
4.2.9.2	PNU 1613/1614: analog output configuration	30
4.2.10	Manufacturer specific object channel (from PNU 1600)	31
5	Process data channel	
5.1	Instrument control	34
5.1.1	Control word (STW)	36
5.1.2	Status word (ZSW)	37
5.2	Operating modes	37
5.2.1	Positioning (operating mode 2)	38
5.2.2	Digital speed (operating mode 1)	39
5.2.3	Analog speed (operating mode -1)	39
5.2.4	Digital torque (operating mode -2)	40
5.2.5	Analog torque (operating mode -3)	40
5.2.6	Electronic gearing (operating mode -4)	40
5.2.7	Trajectory (operating mode -5)	40
5.2.8	ASCII channel (operating mode -16)	41
5.2.9	Operating mode after switch-on (operating mode -126)	41
6	Appendix	
6.1	Example telegrams	43
6.1.1	Zero telegram (for initialization)	43
6.1.2	Setting the Opmode	43
6.1.3	Enable the servo amplifier	44
6.1.4	Start jog mode (on positioning opmode)	44
6.1.5	Set reference point	44
6.1.6	Start homing run	45
6.1.7	Start a motion task	47
6.1.8	Start a direct motion task	47
6.1.9	Polling a warning or error message	47
6.1.10	Writing a parameter (via parameter channel PKW)	48
6.1.11	Reading actual values	48
6.1.12	Write a parameter via the ASCII channel	49
6.2	Index	50

1 General

1.1 About this manual

This manual describes the wiring, setup, range of functions and software protocol for the SERVOSTAR® 300 (S300), SERVOSTAR® 400 (S400), SERVOSTAR® 600 (S600) and S700.

S300, S600 and S700:

The expansion card -PROFIBUS- offers PROFIBUS compatible connectivity to these servo amplifiers. The expansion card and its mounting is described in the instructions manual.

NOTICE

The expansion card for S300 and S700 is different from the card for S600. The text "PROFIBUS DP" on the front label marks the card for S300/S700, the text "PROFIBUS" the card for S600.

S400-PROFIBUS:

PROFIBUS functionality is built-in on delivery.

This manual is part of the complete documentation of the digital servo amplifiers. The installation and setup of the servo amplifier, as well as all the standard functions, are described in the corresponding instructions manuals.

Other parts of the documentation of the digital servo amplifiers:

Title	Publisher
Instructions manual for the Servo Amplifier	Kollmorgen
Online-Help with Object Reference Guide	Kollmorgen

Further documentation:

Title	Publisher
Installation Guideline for PROFIBUS DP/FMS	PNO
Profile for Variable Speed Drives	PNO
SINEC Produktinformation S79200-A0737-X-02-7437	Siemens
SINEC Installationsanleitungen S79200-A0737-X-01-7419	Siemens
SINEC Einführung CP5412 (A2) C79000-G8900-C068	Siemens
SINEC DP-Masterbetrieb mit dem COML DP projektieren C79000-G8900-C069	Siemens
SINEC DP-Programmierschnittstelle C79000-G8900-C071	Siemens

1.2 Target group

This manual addresses personnel with the following qualifications:

Transport :	only by personnel with knowledge of handling electrostatically sensitive components.
Unpacking:	only by electrically qualified personnel.
Installation :	only by electrically qualified personnel.
Setup :	only by qualified personnel with extensive knowledge of electrical engineering and drive technology
Programming:	Software developers, project-planners, experienced PLC programmers with PROFIBUS DP expertise

The qualified personnel must know and observe the following standards:
IEC 60364 and IEC 60664
accident prevention regulations

⚠ WARNING

During operation there are deadly hazards, with the possibility of death, severe injury or material damage. The operator must ensure that the safety instructions in this manual are followed. The operator must ensure that all personnel responsible for working with the servo amplifier have read and understood the instructions manual.

Training courses are available on request.

1.3 Use as directed





Please observe the chapter "Use as directed" in the instructions manual for the servo amplifier. The PROFIBUS interface serves only for the connection of the servo amplifier to a master with PROFIBUS connectivity.

The servo amplifiers are components that are built into electrical apparatus or machinery, and can only be setup and operated as integral components of such apparatus or machinery.

NOTE We can only guarantee the conformity of the servo amplifier with the following standards for industrial areas when the components that we specify are used, and the installation regulations are followed:

EC EMC Directive	2004/108/EEC
EC Low-Voltage Directive	2006/95/EEC

1.4 Symbols used in this manual

Symbol	Indication
	Indicates a hazardous situation which, if not avoided, will result in death or serious injury.
	Indicates a hazardous situation which, if not avoided, could result in death or serious injury.
	Indicates a hazardous situation which, if not avoided, could result in minor or moderate injury.
	Indicates situations which, if not avoided, could result in property damage.
	This is not a safety symbol. This symbol indicates important notes.

1.5 Abbreviations used in this manual

The abbreviations used in this manual are explained in the table below.

Abbrev.	Meaning
AGND	Analog ground
BTB/RTO	Ready to operate
CLK	Clock signal
COM	Serial interface for a PC-AT
DGND	Digital ground
DIN	German Institute for industrial Standards
Disk	Magnetic storage (diskette, hard disk)
EEPROM	Electrically erasable programmable memory
EN	European standard
IEC	International Electrotechnical Commission
INC	Incremental Interface
LED	Light-emitting diode
MB	Megabyte
NI	Zero pulse
NSTOP	Limit-switch input for CCW rotation (left)
PZD	Process data
PSTOP	Limit-switch input for CW rotation (right)
RAM	Volatile memory
RES	Resolver
ROD	A quad B encoder
PLC	Programmable logic controller
S300	SERVOSTAR 300
S400	SERVOSTAR 400
S600	SERVOSTAR 600
SSI	Synchronous serial interface
VAC	AC voltage
VDC	DC voltage

2 Installation / Setup

2.1 Installation

2.1.1 Safety notes

⚠ DANGER

Install and wire up the equipment only while it is not electrically connected. Make sure that the control cabinet is safely isolated (lock-out, warning signs etc.).

The individual supply voltages will not be switched on until setup is carried out.

Residual charges in the capacitors can still have dangerous levels several minutes after switching off the supply voltage. Measure the voltage in the intermediate (DC-link) circuit and wait until it has fallen below 40V.

Power and control connections can still be live, even though the motor is not rotating.

Electronic equipment is basically not failure-proof. The user is responsible for ensuring that, in the event of a failure of the servo amplifier, the drive is set to a state that is safe for both machinery and personnel, for instance with the aid of a mechanical brake.

Drives with servo amplifiers and PROFIBUS expansion cards are remote-controlled machines. They can start to move at any time without previous warning. Take appropriate measures to ensure that the operating and service personnel is aware of this danger.

Implement appropriate protective measures to ensure that any unintended start-up of the machines cannot result in dangerous situations for personnel or machinery. Software limit-switches are not a substitute for the hardware limit-switches in the machine.

⚠ WARNING

Install the servo amplifier as described in the instructions manual. The wiring for the analog setpoint input and the positioning interface, as shown in the wiring diagram in the instructions manual, is not required.

Never break any of the electrical connections to the servo amplifier while it is live. This could result in destruction of the electronics.

NOTE

Because of the internal representation of the position-control parameters, the position controller can only be operated if the final limit speed of the drive does not exceed:

rotatory

at sinusoidal² commutation: 7500 rpm

at trapezoidal commutation: 12000 rpm.

linear

at sinusoidal² commutation: 4 m/s

at trapezoidal commutation: 6.25 m/s

NOTE

All the data on resolution, step size, positioning accuracy etc. refer to calculatory values.

Non-linearities in the mechanism (backlash, flexing, etc.) are not taken into account.

If the final limit speed of the motor has to be altered, then all the parameters that were previously entered for position control and motion blocks must be adapted.

2.1.2 Inserting the expansion card (S300, S600 and S700)

NOTICE

The expansion card for S300/S700 is different from the card for S600. The text "PROFIBUS DP" on the front label marks the card for S300/S700, the text "PROFIBUS" the card for S600.

To fit the PROFIBUS expansion card into the servo amplifier, proceed as follows:

NOTE

- Remove the cover of the option slot (see installation manual of the servo amplifier.)
- Take care that no small items (such as screws) fall into the open option slot.
- Push the expansion card carefully into the guide rails that are provided, without twisting it.
- Press the expansion card firmly into the slot, until the front cover touches the fixing lugs. This ensures that the connectors make good contact.
- Use the screws on the expansion card to secure it in the drive.

2.1.2.1 Front view

Shown is the expansion card for S300/S700.



2.1.2.2 Setup of Station Address and Baud Rate

During setup it makes sense to use the keypad on the front panel to preset the station addresses for the individual amplifiers (see chapter "Setup" in the instructions manual).

NOTE

After changing the station address you must turn the 24V auxiliary supply for the servo amplifier off and on again for the new address to take affect.

Possible ways for setup:

- keypad on the front panel of the servo amplifier (see instructions manual)
- setup software: screen page "CAN / Fieldbus" (see online help)
- serial interface with a sequence of ASCII commands:
ADDR nn ⇒ SAVE ⇒ COLDSTART (with nn = address)

The Baudrate is defined by the hardware configuration in the master controller. Baudrates up to 12 MBaud are possible. During bus initialization, the master controller sends the amplifier the desired baud rate.

2.1.2.3 Connection technology

Cable selection, cable routing, shielding, bus connector, bus termination and transmission times are all described in the "Installation guidelines for PROFIBUS-DP/" from PNO, the PROFIBUS User Organization.

2.1.2.4 Connection diagram

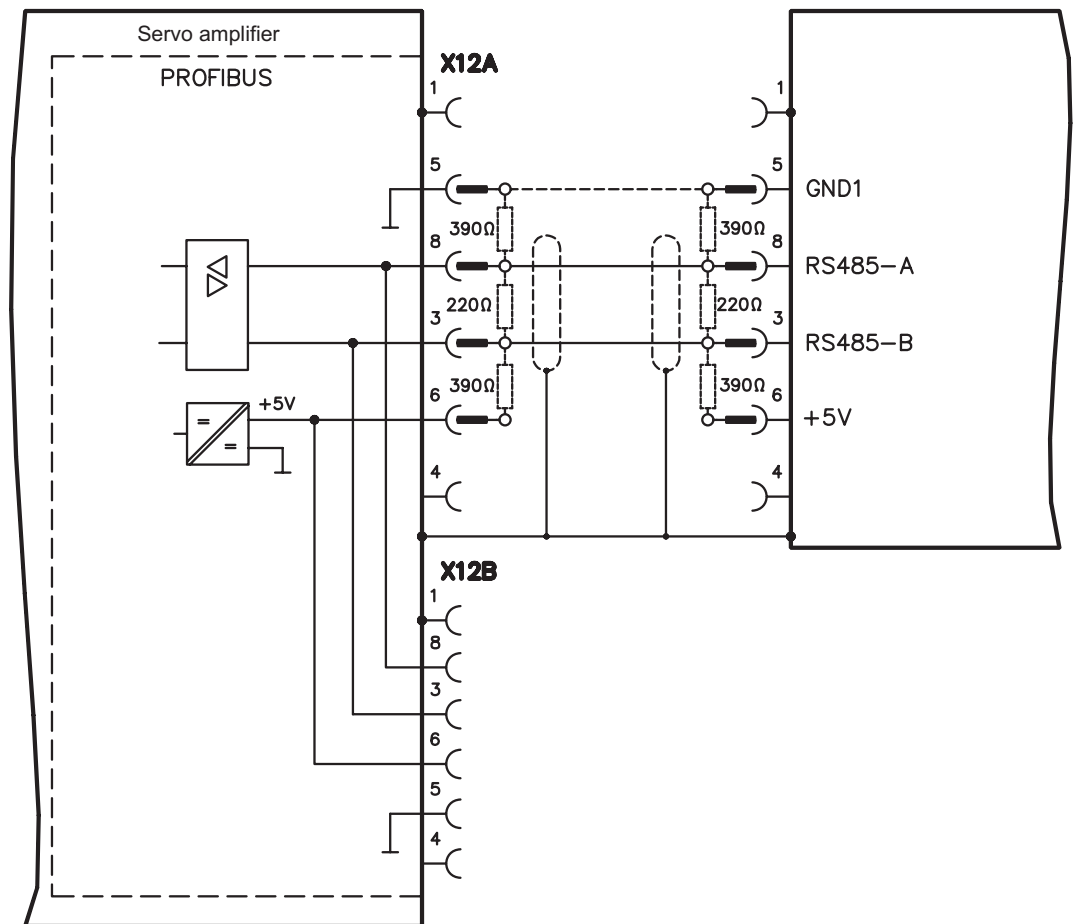

NOTE With S600 terminals AGND and DGND (connector X3) must be joined together !

2.1.3 Profibus master module setup

2.1.3.1 Configuration of the master controller (e.g. Siemens S7)

The graphics interface makes it very easy to configure the Siemens S7 for the PROFIBUS network. After you have set up the control layout, configure the interface module that is used as follows: Use our library file **KOLL045D.GSD** to configure the Profibus master for the servo amplifier. The following shows a Siemens PLC. Other machine controllers can also be configured for the Kollmorgen Profibus expansion card. Open the Hardware catalog and drag the symbol for the corresponding field unit onto the representation of the bus system. A window opens automatically for the general parameterization of the field unit (please observe: the S300/S700 are displayed here like a S600). Enter the address of the participant here.

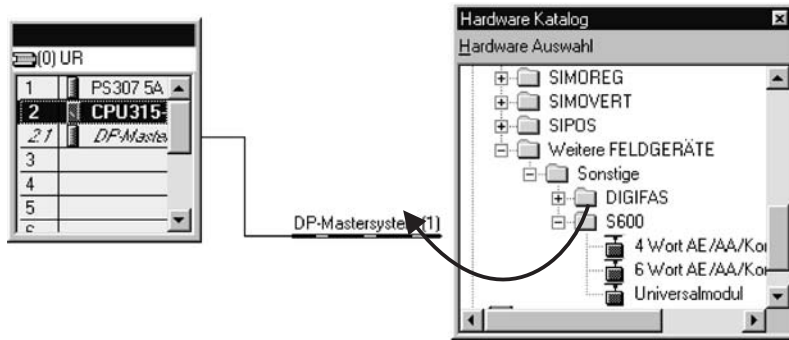

Next, use the same method as above to drag the module from the Hardware catalog into the box for the field unit, whereby the 4-word module must lie in Cell 0 and the 6-word module in Cell 1.

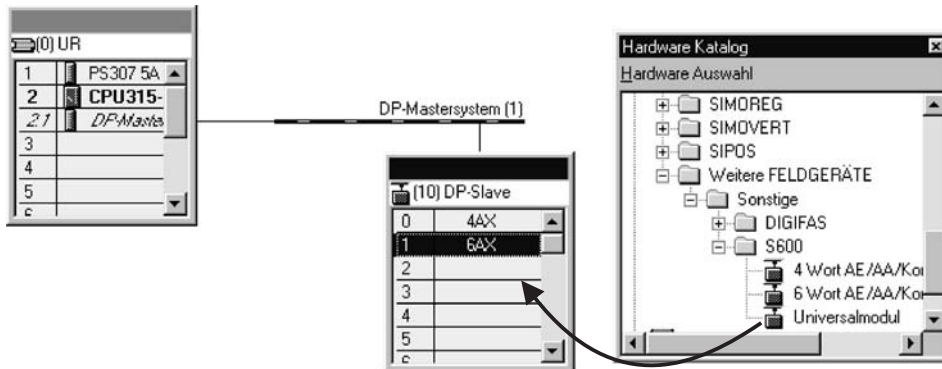

Another window opens, in which you can set the parameters for the module.

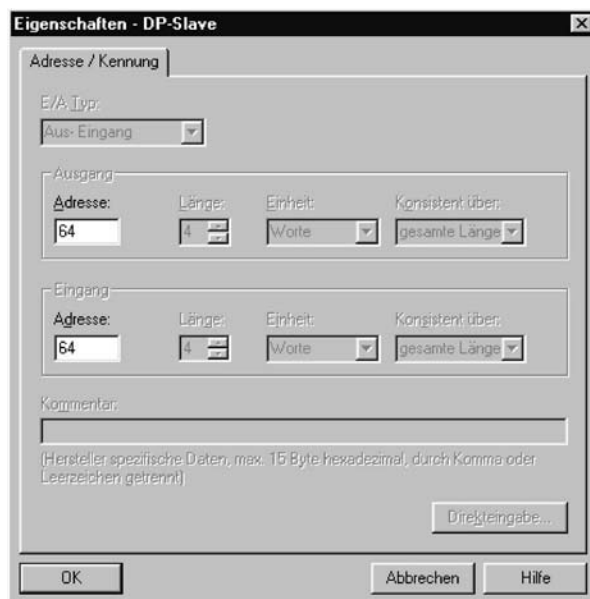

2.1.4 Standard function block for data exchange with the servo amplifier

Kollmorgen supplies a S7-function block (FB10) for use Siemens PLC that make it possible to handle the servo amplifier control functions very simply.

This function block and its description can be found as a text file on the CDROM and in the download section of our website.

2.2 Amplifier setup

2.2.1 Guide to setup

▲ CAUTION Only properly qualified personnel with professional expertise in control and drive technology are permitted to setup the servo amplifier.

Check assembly + installation	Check that all the safety instructions, which are included in both the instructions manual for the servo amplifier and in this manual, have been observed and implemented.
Connect PC, start setup software	Use the setup software for setting the parameters for the servo amplifier.
▲ WARNING	Make sure that any unintended movement of the drive cannot create a danger to personnel or machinery.
Setup the basic functions	Now setup the basic functions of the servo amplifier including tuning the servo loops. This part of setup is described in the online help system of the setup software.
Save parameters	When the optimization is finished, save the controller parameters in the servo amplifier.
Test the bus connection	Remove the Enable signal (Terminal X3) and switch off the mains power supply for the servo amplifier. The 24V DC auxiliary voltage remains switched on. Test the installation of the PROFIBUS connection and the interface to the PROFIBUS master. Check the PROFIBUS-DP parameter settings and the station configuration. Check the parameter settings for the PROFIBUS interface module. Check the PLC user program and the parameter settings for the function block.

2.2.2 Important amplifier configuration parameters

The following parameters configure the amplifier for the Profibus interface. They can be set using the setup software for the amplifier.

EXTWD (PNU 1658)

With this parameter, the observation time (watch dog) for the fieldbus-slot communication can be set. The observation is only active, if a value higher than 0 is assigned to EXTWD (EXTWD=0, observation switched off) and the output stage is enabled. If the set time runs out, without the watchdog-timer being newly triggered by the arrival of a telegram, then the warning n04 (response monitoring) is generated and the drive is stopped. The amplifier remains ready for operation and the output stage enabled. Before a new driving command (setpoint) is accepted, this warning must be deleted (function CLRFAULT or INxMODE=14).

ADDR (PNU 918)

With this command, the node address of the amplifier is set. When the address has been changed, all parameters should be saved to the EEPROM and the amplifier switched off and on again.

Since the modular structure of the S400 as a multi-axis system requires its own addressing, there is the additional parameter **ADDRFB (PNU 2012)** for this series, with which a field bus address different from the internal device address (ADDR) can be defined. As long as ADDRFB = 0, ADDR is the bus address. If ADDRFB > 0, then ADDRFB is the bus address. ADDR is set automatically by the S400 master module in descending order.

AENA (PNU 1606)

With this parameter, the state of the software-enable after switch-on can be defined. The software-enable allows an external control to enable/disable the output stage. For amplifiers with analog setpoints (OPMODE=1,3) the software-enable is set automatically after switch-on and the devices are ready for operation immediately (if hardware-enable is present). For all others, software-enable will be set to the value of AENA. The variable AENA also has functionality when resetting the amplifier after an error (by digital input 1 or the CLRFAULT command). If an error can be reset by the software, the software-enable is set to the value of AENA after the error is cleared. In this way the behavior of the amplifier after a software-reset is similar to after the drive is switched on.

INPT, INPT0 (PNU 1904)

With INPT (S300/S700: INPT0) a delay for the in-position message can be set. With the start of a motion task the in-position message is deleted and the monitoring of the position is activated after expiration of the adjusted time. This function is particularly important for positioning procedures within the in-position window. In this case the in-position message is delayed for a defined time.

2.2.3 Setup Software

2.2.3.1 Screen page PROFIBUS

This screen will only appear, if the PROFIBUS hardware is built into the servo amplifier. The screen page displays the PROFIBUS-specific parameters, the bus status, and the data words in the transmit and receive directions, as seen by the bus-master. This page is helpful when searching for errors and commissioning the bus communication. The picture below shows the S300/S700 screen.

Baudrate: The baud rate set by the PROFIBUS master.

PNO Identno.: The PNO identification is the number for the servo amplifier from the list of ID-numbers set by the PROFIBUS user organization.

Address: Station address of the amplifier (setting see p.8).

PPO type: servo amplifier only supports PPO-type 2 of the PROFIDRIVE profile.

PROFIBUS Interface states:

Shows the present status of the bus communication. Data can only be transferred across the PROFIBUS when the "Communication OK" message is black (not shown in gray).

Input: The last PROFIBUS object received by the master.

Output: The last PROFIBUS object sent by the master.

NOTE

The data for input/output are only transferred, if the threshold monitoring for the servo amplifier has been activated in the master's hardware configuration.

2.2.3.2 Screen page PROFIBUS instrument control

On this screen page the individual bits of the control word (STW) and the status word (ZSW) are shown. The device status resulting from the status word is visualized in the status machine. The current status is shown as black, all others are grey. Additionally the previous status is shown by emphasizing the number of the appropriate arrow. The picture below shows the S300/S700 screen.

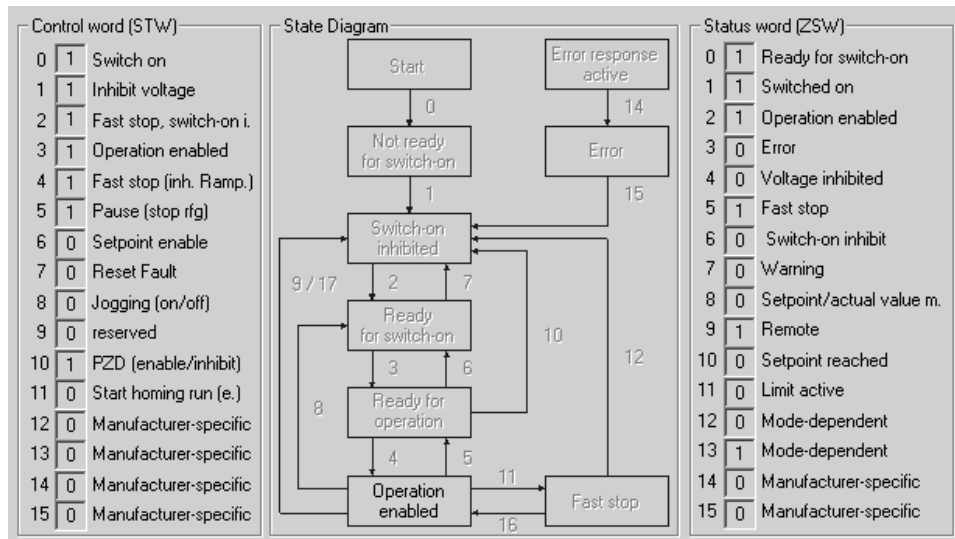

3 Device Profile

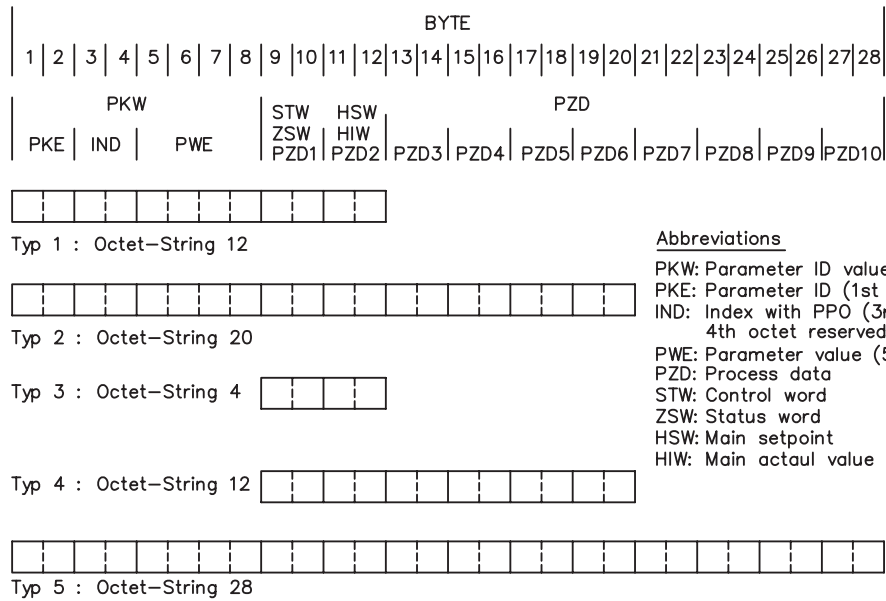

The PROFIBUS-profile PROFIDRIVE includes the following parameter process-data objects (PPO):

The servo amplifier only uses the PPO-type 2 (with 4 words PKW-section and 6 words PZD-section). The PKW-section is used mainly for the transmission of parameters for the servo amplifier, the PZD-section is used principally for handling motion functions.

The telegram can be divided into two sections or data channels:

1. PKW-section (4 words, Bytes 1 to 8)
2. PZD-section (6 words, Bytes 8 to 20)

The PKW data channel can also be termed the service or parameter channel. The service channel only uses confirmed communication services, and is used by the servo amplifier as a parameter channel.

The PKW channel has no real-time capability.

The PZD data channel can also be termed the process data channel. The process data channel uses unconfirmed communication services. The response of the servo amplifier to an unconfirmed service can only be seen in the reaction of the amplifier (status word, actual values).

The PZD channel has real-time capability.

3.1 Parameter channel

3.1.1 Parameter ID (PKE)

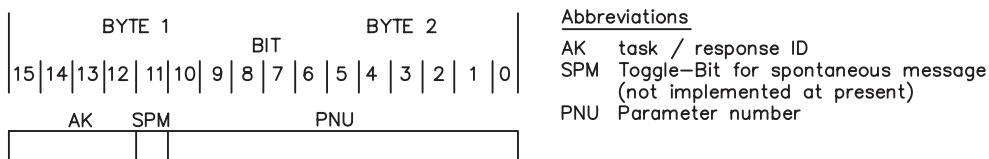

Marked lines in the table are valid for the servo amplifier

Master → Slave		Slave → Master	
Task ID	Function	Response ID positive	Response ID negative
0	no task	0	0
1	request parameter value	1,2	7
2	alter parameter value [W]	1	7/8
3	alter parameter value [DW]	2	7/8
4	request description element	3	7
5	alter description element	3	7/8
6	request parameter value [A]	4,5	7
7	alter parameter value [A/W]	4	7/8
8	alter parameter value	5	7/8
9	request number of array elements	6	7
10 - 15	reserved		

3.1.1.1 Interpretation of the response IDs

Marked lines in the table are valid for the servo amplifier

Response ID	Interpretation
0	no task
1	transmit parameter value
2	transmit parameter value
3	transmit description element
4	transmit parameter value
5	transmit parameter value
6	transmit number of array elements
7	task not possible (with error no.)
8	no operating authority for PKW interface
9	spontaneous message [W]
10	spontaneous message [DW]
11	spontaneous message [A/W]
12	spontaneous message [A/DW]

Abbreviations in the tables:

- A: Array
- W: Word
- DW: Double-word

3.1.1.2 Response ID 7: Profile specific error numbers

Error no.	Description
0	illegal PNU
1	parameter value cannot be changed
2	Lower or upper limit violated
3	Erroneous sub-index
4	no array
5	Incorrect data type
6	setting not allowed (can only be reset)
7	Descriptive element cannot be changed
8	PPO-write, requested in IR, not available
9	descriptive data not available
10	access group incorrect
11	No parameter change rights
12	Password incorrect
13	Text cannot be read in cyclic data transmission
14	Name cannot be read in cyclic data transmission
15	text array not available
16	PPO-write missing
17	opmode switch over not possible at STW Bit 10 = 1 (PZD enable)
18	other error
19-100	reserved
101	faulty task ID
102	software error (command table)
103	only possible in disabled state
104	only possible in enabled state
105	BCC-error in the EEPROM data
106	only possible after task is stopped
107	wrong value [16,20]
108	wrong parameter (OCOPY x [- y] z)
109	wrong motion block no. (0,1..180,192..255)
110	wrong parameter (PTEACH x [y])
111	EEPROM write error
112	wrong value
113	BCC-error in motion block
114	Object is read only or write only
115	not possible due to operation status (e.g. output stage enabled)
>115	reserve

3.1.2 Index IND

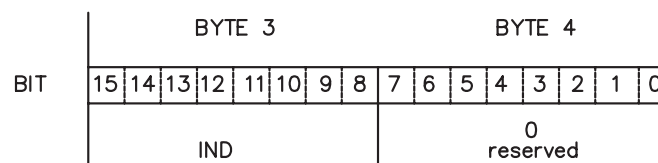
NOTE

An Index (IND) unequal to 0 is used for reading and writing amplifier parameters with PNUs > 1600. See page 31 for further description.

3.1.3 Parameter value PWE

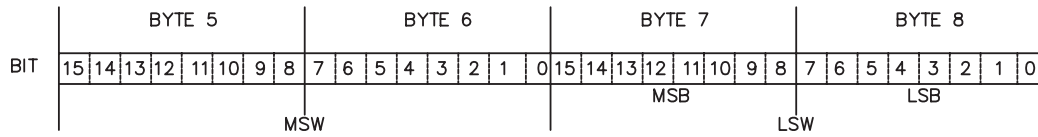

The data for the PNU-variable is contained in the PWE, and is placed flush right (PKE):

4-byte data (double-word) PWE 5-8 (PWE 8 LSB)

Commands are transferred right justified with task ID 3. If a command cannot be executed, the response identification AK = 7 signals the error, and an error number is given out. The error numbers are described on page 17.

3.2 The process data channel (PZD)

Cyclical data are exchanged across the PROFIBUS through the process data section of the 20-byte telegram. Each PROFIBUS cycle triggers an interrupt in the servo amplifier and new process data is exchanged and processed. The interpretation of the PZD by the amplifier depends on the operating mode that is set. The operating mode is set through a PROFIBUS parameter (PNU 930, ⇨ p. 23).

In all operating modes, data word 1 of the process data (PZD1) in the direction from control system to servo amplifier is used for instrument control, and in the direction from servo amplifier to control system it has the function of a status indicator for the amplifier.

The interpretation of the process data PZD2 – PZD6 changes depending on the operating mode, as can be seen in Chapter 5.2.

CAUTION

When the servo amplifier is switched on, the PROFIDRIVE operating mode that is always set to -126 (safe state). Before changing the operating mode, bit 10 of the control word STW must always be set to 0. The new operating mode only becomes active when bit 10 of the control word is set to 1 (see p. 23).

4 Parameter channel (PKW)

The digital servo amplifiers of the servo amplifier series have to be adapted to the circumstances of your machine. The parameters for the controllers are set using either the setup software or via the PROFIBUS.

4.1 Read/write an amplifier parameter

Read (AK = 1) or write (AK = 3) amplifier parameters

To read or write an amplifier parameter through PROFIBUS, the corresponding PNU must be used. The parameters that are written to the servo amplifier can be transferred to the *non-volatile* memory by using the command "non-volatile parameter save" (PNU 971).

Telegram layout:

	Request	Response
PKE/AK	1 (read) / 3 (write)	2 (OK) / 7 (error)
PKE/PNU	see 4.2.1	as transmitted
PWE	for AK = 3 see p.20ff for data type for AK = 1 data type irrelevant	for AK = 3 returns the PWE of the request for AK = 1 see p.20f for data type

4.2 Summary of the parameter numbers

All the parameter numbers (PNUs) for the servo amplifier are listed in numerical order in the table on page 20ff, with a short description. The parameter numbers in the range 900 – 999 are profile-specific for the PROFIBUS drive profile PROFIDRIVE. Parameter numbers > 999 are manufacturer-specific.

For better understanding, you can look up the ASCII commands which are in the column "ASCII command" in the online help the setup software. A description of all ASCII commands can be found in the ASCII reference lists (referring to the servo amplifier type) located on the product CDROM and on our website.

Parameter numbers >1600 use the object channel (see p.31ff).

NOTE

In the S400/S600 some amplifier parameters (e.g. GV) have 2 PNU numbers. Both of them can be used to read and write the parameter (e.g. PNU 1200 and PNU 1672).

4.2.1 List of the parameters

PNU		Data type	Acc	Description	ASCII command		PNU (old) S400/S600
S400/S600	S300/S700				S400/S600	S300/S700	
Profile parameter							
904	904	UINT32	ro	Number of the supported PPO-write, always 2	-	-	904
911	911	UINT32	ro	Number of the supported PPO-read, always 2	-	-	911
918	918	UINT32	ro	Participant address on PROFIBUS	ADDR	ADDR	918
930	930	UINT32	r/w	Selector for operating mode	-	-	930
963	963	UINT32	ro	PROFIBUS baud rate	-	-	963
965	965	Octet-String2	ro	Number of the PROFIDRIVE profile (0302H)	-	-	965
970	970	UINT32	wo	Load default parameter set	RSTVAR	RSTVAR	970
971	971	UINT32	wo	non-volatile parameter save	SAVE	SAVE	971
Manufacturer-specific parameters							
General parameters							
1000	1000	Visible String4	ro	Instrument ID	-	-	1000
1001	1001	UINT32	ro	Manufacturer-specific error register	ERRCODE	ERRCODE	1001
1002	1002	UINT32	ro	Manufacturer-specific status register	-	-	1002
Speed controller parameters							
1672	1672	UINT32	r/w	Kp – gain factor for speed controller	GV	GV	1200
1677	1677	UINT32	r/w	Tn – integral-action time for speed controller	GVTN	GVTN	1201
1676		UINT32	r/w	PID – T2 – time constant for speed controller	GVT2	ARxPx - Filter	1202
1601	1601	UINT32	r/w	Setpoint ramp+, speed controller	ACC	ACC	1203
1634	1634	UINT32	r/w	Setpoint ramp-, speed controller	DEC	DEC	1204
1637	1637	UINT32	r/w	Emergency stop ramp, speed controller	DECSTOP	DECSTOP	1205
1890	1890 / 1891	UINT32	r/w	Maximum speed	VLIM	VLIM / VLIMN	1206
1895	1895	UINT32	r/w	Overspeed	VOSPD	VOSPD	1207
1642	1642	UINT32	r/w	Count direction	DIR	DIR	1208
Position controller parameters							
1894	1894	UINT32	r/w	Velocity multiplier for jogging/homing	VMUL	VMUL	1250
1807	1807	UINT32	r/w	Axis type	POSCNFG	POSCNFG	1251
1798	1798	INTEGER32	r/w	InPosition window	PEINPOS	PEINPOS	1252
1799	1799	INTEGER32	r/w	Following error window	PEMAX	PEMAX	1253
1860	1860	INTEGER32	r/w	Position register 1	SWE1	SWE1	1254
1862	1862	INTEGER32	r/w	Position register 2	SWE2	SWE2	1255
1864		INTEGER32	r/w	Position register 3	SWE3		1256
1866		INTEGER32	r/w	Position register 4	SWE4		1257
1803	1803	UINT32	r/w	Denominator resolution	PGEARO	PGEARO	1258
1802	1802	UINT32	r/w	Numerator resolution	PGEARI	PGEARI	1259
1814	1814	UINT32	r/w	Minimum acceleration/braking time	PTMIN	PTMIN	1260
1669	1669	UINT32	r/w	Feed-forward factor for position controller	GPFFV	GPFFV	1261
1666	1666	UINT32	r/w	KV - factor for position controller	GP	GP	1262
1671		UINT32	r/w	KP - factor for position controller	GPV		1263
1670		UINT32	r/w	Tn - integral-action time for position controller	GPTN		1264
1816	1816	UINT32	r/w	Maximum velocity for positioning mode	PVMAX	PVMAX	1265
1856	1856	UINT32	r/w	Configuration variable for software switch	SWCNFG	SWCNFG	1266
Position data for the position control mode							
1790	1790	INTEGER32	r/w	Position	O P	O P	1300
1791	1791	INTEGER16	r/w	Velocity	O V	O V	1301
1785	1785	UINT32	r/w	Motion task type	O C	O C	1302
1783	1783	INTEGER16	r/w	Starting time (acceleration)	O ACC1	O ACC	1304
1786	1786	INTEGER16	r/w	Braking time (deceleration)	O DEC1	O DEC	1305
1784		INTEGER16	r/w	Jolt limiting (acceleration)	O ACC2		1306
1787		INTEGER16	r/w	Jolt limiting (deceleration)	O DEC2		1307
1788	1788	UINT32	r/w	Number of next motion task	O FN	O FN	1308
1789	1789	UINT32	r/w	Start delay for next motion task	O FT	O FT	1309
1310	1310	2 * UINT16	wo	Copy a motion task	OCOPY	OCOPY	1310
1311		special	r/w	Position, 32 bit floating decimal point format			1311
1312		special	r/w	Velocity, 32 bit floating decimal point format			1312
1857		UINT32	r/w	Configuration variable 2 for software switch	SWCNFG2		1267

PNU		Data type	Acc	Description	ASCII command		PNU (old)
S400/S600	S300/S700				S400/S600	S300/S700	S400/S600
Position set-up mode							
1773	1773	UINT32	r/w	Homing type	NREF	NREF	1350
1644	1644	UINT32	r/w	Homing direction	DREF	DREF	1351
1602	1602	UINT32	r/w	Acceleration ramp (jogging/homing)	ACCR	ACCR	1352
1636	1636	UINT32	r/w	Braking ramp	DECR	DECR	1353
1831	1831	UINT32	r/w	Reference offset	ROFFS	ROFFS	1354
1896	1896	UINT32	ro	Homing run velocity	VREF	VREF	1355
1889	1889	UINT32	ro	Jogging velocity	VJOG	VJOG	1356
Actual values							
1400	1810	INTEGER32	ro	Actual position 20 bits/turn	PRD	PRD	1400
1401		INTEGER32	ro	Speed			1401
1402		INTEGER32	ro	Incremental position, actual value			1402
1800	1800	INTEGER32	ro	SI-position, actual value	PFB	PFB	1403
1815	1815	INTEGER32	ro	SI-velocity, actual value	PV	PV	1404
1797	1797	INTEGER32	ro	SI following error	PE	PE	1405
1688	1688	INTEGER32	ro	RMS current	I	I	1406
1880	1880	INTEGER32	ro	SI-speed, actual value	V	V	1407
1873	1873	INTEGER32	ro	Heatsink temperature	TEMPH	TEMPH	1408
1872	1872	INTEGER32	ro	Internal temperature	TEMPE	TEMPE	1409
1882	1882	INTEGER32	ro	DC-bus (DC-link) voltage	VBUS	VBUS	1410
1792	1792	INTEGER32	ro	Regen power	PBAL	PBAL	1411
1689	1764	INTEGER32	ro	I2t - loading	I2T	MI2T	1412
1876	1876	INTEGER32	ro	Running time	TRUN	TRUN	1413
1414		special	ro	Position, 32 bit floating decimal point format			1414
1415		special	ro	Velocity, 32 bit floating decimal point format			1415
Digital I/O configuration							
1698	1698	UINT32	r/w	Function of digital input 1	IN1MODE	IN1MODE	1450
1701	1701	UINT32	r/w	Function of digital input 2	IN2MODE	IN2MODE	1451
1704	1704	UINT32	r/w	Function of digital input 3	IN3MODE	IN3MODE	1452
1707	1707	UINT32	r/w	Function of digital input 4	IN4MODE	IN4MODE	1453
1699	1699	INTEGER32	r/w	Auxiliary variable for digital input 1	IN1TRIG	IN1TRIG	1454
1702	1702	INTEGER32	r/w	Auxiliary variable for digital input 2	IN2TRIG	IN2TRIG	1455
1705	1705	INTEGER32	r/w	Auxiliary variable for digital input 3	IN3TRIG	IN3TRIG	1456
1708	1708	INTEGER32	r/w	Auxiliary variable for digital input 4	IN4TRIG	IN4TRIG	1457
1775	1775	INTEGER32	r/w	Function of digital input 1	O1MODE	O1MODE	1458
1778	1778	INTEGER32	r/w	Function of digital input 2	O2MODE	O2MODE	1459
1776	1776	UINT32	r/w	Auxiliary variable for digital output 1	O1TRIG	O1TRIG	1460
1779	1779	UINT32	r/w	Auxiliary variable for digital output 2	O2TRIG	O2TRIG	1461
1852	1852	UINT32	r/w	State of 4 digital inputs, Enable, 2 digital outputs	STATIO	STATIO	1462
Analog configuration							
1607	1607	UINT32	r/w	Configuration of the analog input functions	ANCNFG	ANCNFG	1500
1613		UINT32	r/w	Configuration monitor function analog output 1	ANOUT1		1501
1611	1611	UINT32	r/w	Offset voltage for analog input 1	ANOFF1	ANOFF1	1502
1617	1617	UINT32	r/w	Filter time constant for analog input 1	AVZ1	AVZ1	1503
1897	1897	UINT32	r/w	Scaling factor for velocity, analog input 1	VSCALE1	VSCALE1	1504
1713	1713	UINT32	r/w	Scaling factor for current, analog input 1	ISCALE1	ISCALE1	1505
1614		UINT32	r/w	Configuration monitor function analog output 2	ANOUT2		1506
1612	1612	UINT32	r/w	Offset voltage for analog input 2	ANOFF2	ANOFF2	1507
1898	1898	UINT32	r/w	Scaling factor for velocity, analog input 2	VSCALE2	VSCALE2	1508
1714	1714	UINT32	r/w	Scaling factor for current, analog input 2	ISCALE2	ISCALE2	1509
Motor parameters							
1735	1735	UINT32	r/w	Brake configuration	MBRAKE	MBRAKE	1550
1753	1753	UINT32	r/w	Motor number from motor database	MNUMBER	MNUMBER	1551
Manufacturer specific object channel							
≥1600				⇒ p. 31 and description of the ASCII-commands in the online help.			≥1600

Abbreviations in the "Access" column

Abbrev.	Description
wo	"write only" access
ro	"read only" access
r/w	read and write access

4.2.2 Standard PROFIDRIVE parameters

4.2.2.1 PNU 940/911: PPO type write/read

These parameters describe the numbers of the supported PPO-types write und read. Since only PPO-type 2 is supported (see Chapter 3), this parameter is always set to 2.

4.2.2.2 PNU 918: PROFIBUS node address

With this parameter the PROFIBUS - node address of the amplifier can be read.

S400/S600

The range of addresses can be extended from 1..63 to 1..127 with the ASCII-command MDRV.

Setting up the station address, see page 8.

4.2.2.3 PNU 963: baud rate

This parameter defines the index of the baud rate that is used for PROFIBUS communication, and can only be read. The baud rate is given out by the PROFIBUS-master.

The table below shows the indices with the according baud rates (in kBaud):

Index	0	1	2	3	4	5	6	7	8	9
Baud rate	12000	6000	3000	1500	500	187.5	93.75	45.45	19.2	9.6

4.2.2.4 PNU 965: PROFIDRIVE profile number

This parameter can be used to read out the number of the PROFIDRIVE profile. Profile Number 3, Version 2 is used.

4.2.2.5 PNU 970: default parameters

With this parameter you can reject all the parameters that are set and load the manufacturer's default values.

4.2.2.6 PNU 971: non volatile saving of parameters

With this parameter you can save all the parameter settings to the EEPROM. To do this, the parameter must have the value PWE = 1 when the transfer takes place.

4.2.2.7 PNU 930: Selection Switch for Operating Mode

The “Selector for operating modes” is defined by the drive profile, and mirrors the operating modes of the drive profile to the operating modes of the servo amplifier. The following table shows a summary of the operating modes:

NOTE

If process data are exchanged across the PROFIBUS, then the operating modes of the drive profile must only be selected with PNU 930.

Operating mode of drive profile	Operating mode servo amplifier (ASCII command “OPMODE”)	Description
2	8	Positioning mode according to PROFIDRIVE profile
1	0	Digital speed control according to PROFIDRIVE profile
0	-	reserved
-1	1	Speed control, analog setpoint
-2	2	Torque control, digital setpoint
-3	3	Torque control, analog setpoint
-4	4	Position control, electronic gearing
-5	5	Position control, external trajectory
-6 to -15	-	reserved
-16	-	ASCII channel for expanded parameterization
-17 to -125	-	reserved
-126	-	Initial settings when amplifier is switched on

The individual operating modes are described in chapter 5.2. A change of operating mode can only be undertaken in connection with the control word.

The operating mode must be changed according to the following sequence:

- Inhibit setpoints and process data**
 Bit 10 in the control word is set to 0, so that no new setpoints will be accepted by the servo amplifier and no new control functions can be initiated. A new operating mode can, however, be selected while a motion function is being performed. The control word is only inhibited to the extent that the servo amplifier can always be switched into a safe state.
- Select the new operating mode with PNU 930**
 The new operating mode is selected with parameter 930 through the parameter channel, but not yet accepted.
- Set/receive the setpoints and actual values**
 Enter the corresponding setpoints in the setpoint area of the process data. Here you must take note that the normalization and data formats depend on the operating mode that is selected. The interpretation of the actual values is also altered (see ⇒ p. 15 and p. 37ff). The user program must respond accordingly.
- Enable the setpoints**
 Bit 10 of STW is set to 1. The setpoints are immediately accepted and processed. The new actual values are output with the appropriate normalization and data format.

CAUTION

After switch-on or after a coldstart the servo amplifier is always in the safe operating mode. In the safe operating mode (-126), no motion functions can be initiated via the PROFIBUS. However, it is possible to perform motion functions with the the setup Software. If the operating mode is changed, then motion functions can only be operated via the PROFIBUS. If the operating mode is changed via another communication channel, then the amplifier is emergency braked and the error F21 (Handling error, expansion card) is signaled.

4.2.3 Manufacturer specific parameters

4.2.3.1 PNU 1000: instrument ID

The instrument ID consists of four ASCII characters, with the contents "Sxyz".

- x stands for the servoamplifier family
- yz stands for the current level of the output stage

4.2.3.2 PNU 1001: manufacturer specific error register

The assignment of the error register can be seen in the following table. The explanation of the individual errors can be found in the assembly & installation instructions for the servo amplifier.

Bit	Description
0	Error F01: Heatsink temperature
1	Error F02: Overvoltage
2	Error F03: Following error
3	Error F04*: Feedback
4	Error F05: Undervoltage
5	Error F06*: Motor temperature
6	Error F07*: Auxiliary voltage
7	Error F08: Overspeed
8	Error F09*: EEPROM
9	Error F10*: Flash-EEPROM
10	Error F11*: Mechanical holding brake
11	Error F12*: Motor phase
12	Error F13: Internal temperature
13	Error F14*: Output stage
14	Error F15: I ² t max.
15	Error F16: Mains supply-BTB
16	Error F17*: A/D-converter
17	Error F18*: Regen circuit
18	Error F19: Mains supply phase
19	Error F20*: Expansion card error
20	Error F21*: Handling error, plug-in card
21	Error F22: Earth short
22	Error F23: CAN-Bus off
23	Error F24: Warning
24	Error F25: Commutation error
25	Error F26: Limit switch
26	Error F27: AS functionality
27-30	Error F28 - F31*: reserved
31	Error F32*: System error

When the cause of the error has been cleared, the error state can be canceled by setting Bit 7 in the control word (STW).

The error response of the servo amplifier to the reset will differ, depending on the error that has occurred:

For errors that are marked by an asterisk (*), setting the reset bit initiates a cold-start of the amplifier, whereby the PROFIBUS communication to this amplifier will also be interrupted for several seconds. Depending on the circumstances, this break in communication may have to be separately handled by the PLC.

For the other errors, the reset leads to a warm start, during which the communication will not be interrupted.

A description of the individual errors and recommendations for removing them can be found in the amplifier's installation manual.

4.2.3.3

PNU 1002: manufacturer specific status register

The bit assignment can be seen in the following table:

Bit	Description
0	Warning 1: I ² t threshold exceeded (set, as long as I _{rms} is above the threshold)
1	Warning 2: Regen power exceeded (set, as long as the set regen power is exceeded)
2	Warning 3: Following error
3	Warning 4: Threshold monitoring (field bus) active
4	Warning 5: Mains supply phase missing
5	Warning 6: Software limit-switch 1 has been activated
6	Warning 7: Software limit-switch 2 has been activated
7	Warning 8: Faulty motion task has been started
8	Warning 9: No reference point was set at the start of the motion task
9	Warning 10: PSTOP active
10	Warning 11: NSTOP active
11	Warning 12: Motor default values were loaded (HIPERFACE® or EnDat® feedback)
12	Warning 13: Expansion card is not working properly
13	Warning 14: Sine encoder commutation not carried out
14	Warning 15: Speed - current table error INxMODE 35
15	Warning 16: Reserve
16	Motion task active (is set as long as a position control task is active - motion task, jogging, homing).
17	Reference point set (is set after a homing run, or when an absolute position (multi-turn) encoder is used. This is canceled when the amplifier is switched on, or when a homing run is started.
18	Actual position = home position (is set as long as the reference switch is activated).
19	InPosition (is set as long as the difference between the target position for a motion task and the actual position is smaller than PEINPOS. The InPosition signal is suppressed if a following task is started at the target position.
20	Position latch set (positive edge) – this is set if a rising edge is detected on the INPUT2 (IN2MODE=26) that is configured as a latch. This is canceled if the latched position is read out (LATCH16/LATCH32)
21	—
22	Position 1 reached (is set if the configured condition for this signal (SWCNFG, SWE1, SWE1N) is met. Depending on the configuration, this bit is set on exceeding SWE1, or going below SWE1, on reaching the InPosition window SWE1...SWE1N or on leaving the InPosition window SWE1...SWE1N.
23	Position 2 reached (see above)
24	Position 3 reached (see above)
25	Position 4 reached (see above)
26	Initialization completed (is set if the internal initialization of the amplifier is completed).
27	—
28	Speed = 0 (is set as long as the motor speed is below the standstill threshold VELO).
29	Safety relay has been triggered (is set as long as the safety relay is open AS)
30	Output stage enabled (is set when software and hardware enables are set).
31	Error present (is canceled when the amplifier is switched on, or if the function "Cancel error" is called.

In the process data, Bits 16 to 31 of the manufacturer-specific status register are given out.
Warnings 3 and 4 can be reset through Bit 13 in the control word.

4.2.4 Position control parameters

4.2.4.1 PNU 1894: velocity multiplier

This parameter is used to enter a multiplier for the jogging/homing velocity. In Positioning opmode, the velocity for jogging/homing is set through PZD2 jogging/homing is started using bit 8/ bit 11 in the control word (STW).

The actual jog velocity is calculated according to the following formula:

$$V_{Jog,vel. (32Bit)} = V_{Jog,PZD2 (16Bit)} \times velocity\ multiplier(16Bit)$$

The default value for PNU 1894 is 1.

4.2.4.2 PNU 1807: axis type

This parameter is used to define the axis type.

Value	S300/S700	S400	S600
0	Linear axis	Linear axis	Linear axis
1	Modulo axis	Rotary axis	Rotary axis
2		Modulo axis	Modulo axis

4.2.5 Position data for the position control mode

4.2.5.1 PNU 1790: position

Since the servo amplifier calculates all positioning operations internally only on an incremental basis, there are limitations on the usable range of values for distances that are given in SI (user) units.

The range for the incremental position covers the values from -2^{31} to $(2^{31}-1)$.

The resolution that is determined by the PGEARO (PNU1803 ind1) and PGEARI (PNU1802 ind1) parameters and the variable PRBASE fix the sensibly usable range for positioning operations.

The variable PRBASE determines, through the equation $n = 2^{PRBASE}$, the number of increments per motor turn. The value of PRBASE can only be 16 or 20.

PGEARO contains the number of increments that must be traversed when the distance to be moved is PGEARI. The default values for PGEARO correspond to one turn.

The number of turns that can be covered are given as follows:

-2048..+2047 for PRBASE=16 and -32768..+32767 for PRBASE=20

The sensibly usable position range is derived as follows:

$$\begin{aligned}
 & -2^{31} * \frac{PGEARI}{PGEARO} \dots (2^{31} - 1) * \frac{PGEARI}{PGEARO} && \text{for PGEARI} \leq \text{PGEARO} \text{ or} \\
 & -2^{31} \dots (2^{31} - 1) && \text{for PGEARI} > \text{PGEARO}
 \end{aligned}$$

4.2.5.2 PNU 1791: velocity

The usable range for the velocity is not limited by the available data area. It is limited by the maximum applicable speed n_{max} , which is given by the speed parameter VLIM as the final limit speed for the motor.

The maximum velocity is thus given by:

$$n_{SI,max} = n_{max} \times \frac{PGEARI}{PGEARO} \times 2^{PRBASE} \quad \text{with } n_{max} \text{ in turns/second}$$

or, in incremental units, as:

$$v_{incr,max} = n_{max} \times 2^{PRBASE} \times \frac{250ms}{1sec} = \frac{n_{max}}{4000} \times 2^{PRBASE} \quad \text{with } n_{max} \text{ in turns/second}$$

4.2.5.3 PNU 1785: motion task type

Bit	Value	Meaning
0	0	The position value that is given is evaluated as an absolute position.
	1	The position value that is given is evaluated as a relative traversing distance. The two following bits then determine the type of relative motion.
1	0	If Bit 1 and Bit 2 are set to 0 and Bit 0 set to 1, then the relative motion task is performed according to the "InPosition" bit.
	1	The new target position is given by the old target position plus the traversing distance. Bit 1 has priority over Bit 2.
2	0	If Bit 1 and Bit 2 are set to 0 and Bit 0 set to 1, then the relative motion task is performed according to the "InPosition" bit.
	1	The new target position is given by the actual position plus the traversing distance.
3	0	no following task available
	1	There is a following task, but it must be defined through parameter O_FN, PNU 1788
4	0	Change over to next motion task, with braking to 0 at the target position.
	1	Change over to next motion task, without standstill at the target position. The type of velocity transition is determined by Bit 8.
5	0	Change over to next motion task, without evaluating inputs.
	1	A following motion task is started by a correspondingly configured input.
6	0	Start the next motion task by Input State = low or if bit 7 = 1 after the delay set in PNU 1789.
	1	Start the next motion task by Input State = high or if bit 7 = 1 after the delay set in PNU 1789.
7	0	The next motion task is started immediately.
	1	The next motion task is started after the delay time set by PNU 1789 or, if Bit 6 = 1, previously by a corresponding input signal.
8	0	Only for following motion tasks and Bit 4 = 1: from the target position for the previous motion task onwards, the velocity is altered to the value for the following motion task.
	1	The change of velocity is made so that the velocity at the target position of the previous motion task matches the value given for the following motion task.
9		
10	-	reserved
11		
12	0	Accelerations are calculated according to the run-up/acceleration and run-down/braking times for the motion task.
	1	the deceleration/acceleration ramps are interpreted in mm/s ²
13	0	The target position and target velocity of a motion task are interpreted as increments.
	1	The target position and target velocity are recalculated as increments before the start of the motion task. The parameters PGEAR1 and PGEARO are used for this purpose.
14	0	The programmed velocity is used as the velocity for the motion task.
	1	The velocity for the motion task is determined by the voltage present on analog input 1 at the start of the motion task.
15	-	reserved
16	0	S300/S700 only: a motion task with trapezoid profile is started
	1	S300/S700 only: a table motion task (sin ² profile) is started. Bit 9 must be set to 0.

Bits 0 to 15 are transmitted as motion task type in PZD 6 (mode "positioning") with direct motion tasks.

Bit 16 is not affected by the motion task type transmitted with the process data in PZD 6 and therefore must be written with PNU 1785 to the parameter channel.

4.2.5.4 PNU 1783: acceleration time

This parameter defines the total time or rate (depending on the type of units selected for acceleration) to reach the target velocity for the motion task.

4.2.5.5 PNU 1784: acceleration jolt limiting

For S400/S600 only. This parameter defines the form of the acceleration ramp. If a value $\neq 0$ is entered here, then a \sin^2 -ramp (S-curve) is used to reach the target velocity. To employ sine²-ramps, the configuration variable SPSET has to be set to 2 (via the ASCII-channel or the ASCII-terminal in the setup software) and to be saved.

4.2.5.6 PNU 1786: deceleration time

This parameter defines the total time or rate (depending on the type of units selected for deceleration) to reduce the velocity to 0 at the target position.

4.2.5.7 PNU 1787: deceleration jolt limiting

For S400/S600 only. This parameter defines the form of the braking/deceleration ramp. If a value $\neq 0$ is entered here, then a \sin^2 -ramp (S-curve) is used for braking/deceleration.

4.2.5.8 PNU 1788: next motion task

S400/S600:

The motion task number of the motion task to be started can be from 1 to 180 (motion tasks in EEPROM) or 192 to 255 (motion tasks in RAM).

S300/S700:

The motion task number of the motion task to be started can be from 1 bis 200 (motion tasks in EEPROM) or 201 .. 300 (motion tasks in RAM).

4.2.5.9 PNU 1789: start delay

This parameter is used to set a delay time before the start of a motion task.

4.2.5.10 PNU 1310: copy motion task

This parameter can be used to copy motion tasks. The source motion task must be entered in the high-value portion of PWE (PZD 5 & 6) and the target motion task must be entered in the low-value portion of PWE (PZD 7 & 8).

4.2.5.11 PNU 1311: position, 32 bit floating decimal point format

For S400/S600 only. With this object the target position for motion task 0 (direct motion task, see ASCII – command O_P) can be set in 32 Bit Floating decimal point format (IEEE).

Right of decimal point positions will be truncated. This objekt is, aside from the data format, identical PNU 1790. The defaults are indicated in micrometers.

Use:

Controls that support only 16 Bit integer and 32 Bit floating decimal point.

4.2.5.12 PNU 1312: velocity, 32 bit floating decimal point format

For S400/S600 only. With this object the velocity for motion task 0 (direct motion task, see ASCII – command O_V) can be set in 32 Bit Floating decimal point format (IEEE).

Right of decimal point positions will be truncated. This objekt is, aside from the data format, identical PNU 1791.

Use:

Controls that support only 16 Bit integer and 32 Bit floating decimal point.

4.2.6 Setup mode: position**4.2.6.1 PNU 1773: homing type**

This parameter can be used to determine which type of homing run should be applied. The assignment can be seen in the following table:

PWE	Type of homing run
0	Reference point at the present position
1	Initiator with resolver zero mark
2	Hardware limit-switch resolver zero mark
3	Initiator without resolver zero mark
4	Hardware limit-switch without resolver zero mark
5	Zero mark / feedback unit
6	Reference point at the actual position
7	Hardware limit-switch with resolver zero mark
8	Absolute SSI-position
9	Move to Mechanical Stop

4.2.6.2 PNU 1644: homing direction

This parameter can be used to determine the direction of motion for homing runs. If set equal 0, then the direction of motion is negative; for a value 1 it is positive, and for a 2 it depends on the distance to the reference point in the direction in which the homing run started.

4.2.7 Actual values**4.2.7.1 PNU 1401: speed**

For S400/S600 only.

The parameter value is the actual speed of the motor in increments / 250 µsec, which are the amplifier's internal units.

4.2.7.2 PNU 1402: incremental position, actual value

For S400/S600 only.

The parameter value is the actual position value in increments.

4.2.7.3 PNU 1800: actual position value in SI (User) units

The parameter value is the actual SI (user unit) position value.

4.2.7.4 PNU 1414: actual position, 32 bit floating decimal point format

For S400/S600 only. With this object the actual position (see ASCII-command PFB) can be read in a 32 Bit Floating decimal point format (IEEE).

Right of decimal point positions will be truncated. This object is, aside from the data format, identical to PNU1800.

Use:

PLC Controls that support only 16 Bit integer and 32 Bit floating decimal point.

4.2.7.5 PNU 1415: actual velocity, 32 bit floating decimal point format

For S400/S600 only. With this object the actual velocity (see ASCII-command PV) can be read in a 32 Bit Floating decimal point format (IEEE).

Right of decimal point positions will be truncated. This object is, aside from the data format, identical to PNU1815.

Use:

PLC Controls that support only 16 Bit integer and 32 Bit floating decimal point.

4.2.8 Digital I/O configuration

All settings for the digital inputs and outputs only become effective after being saved in the EEPROM and then switching off and on again, or making a cold start of the servo amplifier. Details on each configuration setting can be seen in the user manual for the setup software.

4.2.8.1 PNUs 1698/1701/1704/1707: digital input configuration

This parameter can be used to configure the digital inputs 1 to 4 individually.

The configurable functions depend on the used amplifier and are described in the ASCII Object Reference.

4.2.8.2 PNUs 1775/1778: digital output configuration

These parameters can be used to configure the two digital outputs individually. The configurable functions depend on the used amplifier and are described in the ASCII Object Reference.

4.2.9 Analog configuration

All settings for the analog inputs and outputs only become effective after being saved in the EEPROM and then switching off and on again, or making a cold start of the servo amplifier. The significance of the functions can be seen in the user manual for the setup Software.

4.2.9.1 PNU 1607: analog input configuration

This parameter can be used to configure the two analog inputs together. The configurable functions depend on the used amplifier and are described in the ASCII Object Reference.

4.2.9.2 PNU 1613/1614: analog output configuration

With S400/S600 only. This parameter can be used to configure the two analog outputs individually.

PWE	Function
0	Off
1	n act
2	l act
3	n setp
4	l setp
5	S_fault
6	Slot

4.2.10

Manufacturer specific object channel (from PNU 1600)

With PNUs>1600 you can programm each ASCII-parameter/command of the servo amplifier. The PNU can be calculated by the object number with a specific offset (ASCII command reference list: DPR).

All PNUs described in this manual can be reached with index=1. In the ASCII reference list you find for every parameter the PNU and the referring index. More functions of the object channel can be used with the indices listed below.

The offset and the indices that must be used depend on the object number:

Objekt number	Offset	PNUs	Index
0 ...447	1600	1600 ...2047	00h ...08h (1 ... 8dez)
448 ...847	1200	1648 ...2047	10h ...18h (16 ... 24dez)
848 ...1047	800	1648 ...2047	20h ...28h (32 ...40dez)

Index	0/10h/ 20h depending on the object no. (see above)
short description	Number of entries
Unit	—
Access	ro
Data type	UNSIGNED8
Value range	8
EEPROM	—

Index	1/11h/ 21h depending on the object no. (see above)
short description	read/write a parameter
Unit	see corresponding ASCII-command
Access	see corresponding ASCII-command
Data type	see corresponding ASCII-command
Value range	see corresponding ASCII-command
Default value	—
EEPROM	see corresponding ASCII-command

Index	2/12h/ 22h depending on the object no. (see above)
short description	read lower limit
Unit	see corresponding ASCII-command
Access	Read only
Data type	see corresponding ASCII-command
Value range	see corresponding ASCII-command
Default value	—
EEPROM	—

Index	3/13h/ 23h depending on the object no. (see above)
short description	read upper limit
Unit	see corresponding ASCII-command
Access	Read only
Data type	see corresponding ASCII-command
Value range	see corresponding ASCII-command
Default value	—
EEPROM	—

Index	4/14h/ 24h depending on the object no. (see above)
short description	read default value
Unit	see corresponding ASCII-command
Access	Read only
Data type	see corresponding ASCII-command
Value range	see corresponding ASCII-command
Default value	—
EEPROM	—

Index	5/15h/ 25h depending on the object no. (see above)
short description	read object format
Unit	—
Access	Read only
Data type	see corresponding ASCII-command
Value range	see corresponding ASCII-command
Default value	—
EEPROM	—

Description:

The following object formats are possible:

- 0 Function (no parameters – write only)
- 1 Function (32-Bit parameter)
- 2 Function (32-Bit parameter with weighting 3)
- 3 8-Bit integer
- 4 8-Bit unsigned integer
- 5 16-Bit integer
- 6 16-Bit unsigned integer
- 7 32-Bit integer
- 8 32-Bit unsigned integer
- 9 32-Bit integer (weighting 3)

Index	6/16h/ 26h depending on the object no. (see above)
short description	read object control data
Unit	—
Access	Read only
Data type	UNSIGNED32
Value range	0 ... $2^{32} - 1$
Default value	—
EEPROM	—

Description:

- 0x00010000 when altered, the variable has to be saved and the amplifier reset
- 0x00020000 variable will be saved in the serial EEPROM
- 0x00200000 variable is read-only, must not be written via PROFIBUS

Index	7/17h/ 27h and 8/18h/ 28h
short description	reserved
Unit	—
Access	Read only
Data type	UNSIGNED32
Value range	0 ... $2^{32} - 1$
Default value	—
EEPROM	—

NOTE

Objects with format 0 (index 5) must not be accessed reading (response identification = 1)

5 Process data channel

The process data channel is used for real-time communication. This channel is divided into two telegram sections:

- PZD1: Control word (STW) /Status word (ZSW) – instrument control
The control word and the status word are used to control the amplifier and monitor the amplifier's status.
- PZD2-6: Setpoint / actual values depending on the operating mode.
Setpoints and actual values such as position, velocity and current are exchanged in this section.

The availability of a process data channel is determined in the PROFIDRIVE drive profile. The data that can be transferred is defined according to the operating mode (see "Setting the operating mode s" chapter 4.2.2.7). The process data that are used are determined in such a way that the real-time capability of this channel is optimally used.

In this chapter the instrument control is described first, and then the functions and details of each operating mode .

5.1 Instrument control

The control of the amplifier through PROFIBUS is described with the aid of the status machine shown below. The status machine is defined in the drive profile by a flow diagram valid for all operating modes. The following diagram shows different amplifier states for the servo amplifier.

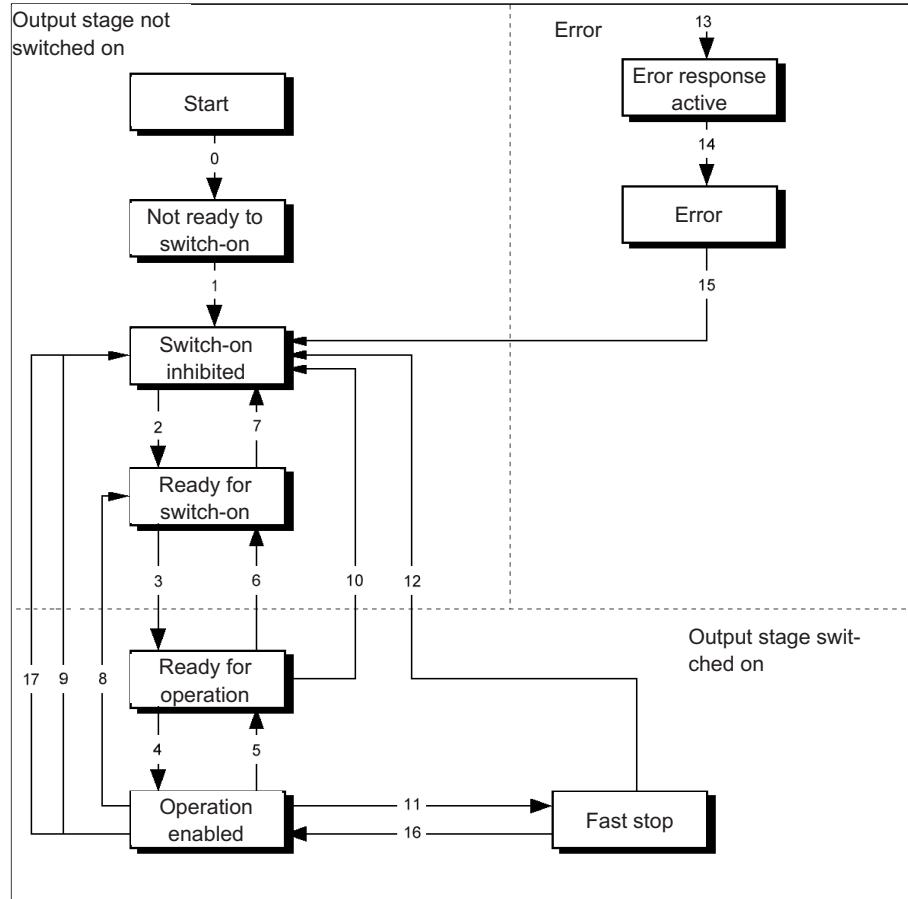

The following table describes the amplifier states and the transitions.

States of the status machine

State	Description
Not ready for switch-on	servo amplifier is not ready for switch-on. No operation readiness (BTB) is signaled from the amplifier software.
Switch-on inhibited	servo amplifier is ready for switch-on. Parameters can be transferred, DC bus link can be switched on, motion functions cannot be carried out yet.
Ready for switch-on	DC bus link voltage must be switched on. Parameters can be transferred, motion functions cannot be carried out yet.
Ready for operation	DC bus link voltage must have been switched on. Parameters can be transferred, motion functions cannot be carried out yet. Output stage is switched on (enabled).
Operation enabled	No error present. Output stage is switched on, motion functions are enabled.
Fast stop activated	Drive has been stopped, using the emergency stop ramp. Output stage is switched on (enabled), motion functions are enabled.
Error response active/error	If an amplifier error occurs, the servo amplifier changes to the amplifier state "Error response active". In this state, the power stage is switched off immediately. After this error response has taken place, it changes to the state "Error". This state can only be terminated by the bit-command "Error-reset". To do this, the cause of the error must have been removed (see ASCII command ERRCODE).

Transitions of the status machine

Transition	Description	
0	Event	Reset / 24V supply is switched on
	Action	Initialization started
1	Event	Initialization successfully completed, servo amplifier switch-on inhibit
	Action	none
2	Event	Bit 1 (inhibit voltage) and Bit 2 (fast stop) are set in the control word (command: shutdown). DC bus link voltage is present.
	Action	none
3	Event	Bit 0 (switch-on) is also set (command: switch-on)
	Action	Output stage is switched on (enabled). Motor has torque.
4	Event	Bit 3 (operation enabled) is also set (command: operation enable)
	Action	Motion functions are enabled, depending on the operating mode that is set.
5	Event	Bit 3 is canceled (command: inhibit)
	Action	Motion functions are disabled. Motor is braked, using the relevant ramp (depends on operating mode).
6	Event	Bit 0 is canceled (ready for switch-on).
	Action	Output stage is switched off (disabled). Motor has no torque.
7	Event	Bit 1 or Bit 2 is canceled.
	Action	(Command: "Fast stop" or "Inhibit voltage")
8	Event	Bit 0 is canceled (operation enabled -> ready for switch-on)
	Action	Output stage is switched off (disabled) - motor has no torque.
9	Event	Bit 1 is canceled (operation enabled -> switch-on inhibited)
	Action	Output stage is switched off (disabled) - motor has no torque.
10	Event	Bit 1 or 2 are canceled (ready for operation -> switch-on inhibited)
	Action	Output stage is switched off (disabled) - motor has no torque.
11	Event	Bit 4 is canceled (operation enabled -> fast stop)
	Action	Drive is stopped, using the emergency ramp. The output stage remains enabled. Setpoints are canceled (e.g motion block number, digital setpoint).
12	Event	Bit 1 is canceled (fast stop -> switch-on inhibited)
	Action	Output stage is switched off (disabled) - motor has no torque.
13	Event	Error response active
	Action	Output stage is switched off (disabled) - motor has no torque.
14	Event	Error
	Action	none
15	Event	Bit 7 is set (error -> switch-on inhibited)
	Action	Acknowledge error (depending on error – with/without reset)
16	Event	Bit 4 is set (fast stop -> operation enabled)
	Action	Motion function is enabled again.
17	Event	Bit 2 is canceled
	Action	Switch-on inhibited, output stage disabled

The state transitions are affected by internal events (e.g. switching off the DC-link voltage) and by the flags in the control word (Bits 0, 1, 2, 3, 7).

5.1.1 Control word (STW)

With the aid of the control word, you can switch from one amplifier state to another. In the diagram for the state machine you can see which instrument states can be reached by which transitions. The momentary amplifier state can be taken from the status word.

Several states may be passed through during one telegram cycle, e.g.

Ready for switch on → Ready for operation → Operation enabled.

The bits in the control word can be (operating-) **mode-dependent** or **mode-independent**.

The following table describes the bit assignment in the control word.

Bit	Name	Commentary
0	Switch on	—
1	Inhibit voltage	—
2	Fast stop, switch-on inhibited	1 -> 0 drive decelerates using emergency ramp, axis is disabled (See also ASCII-commands STOPMODE and DECDIS)
3	Operation enabled	—
4	Fast stop (inhibit rfg)	1 -> 0 drive decelerates using emergency ramp, the amplifier remains enabled
5	Pause (stop rfg)	Operating mode dependent, 1 -> 0 stops motion
6	Setpoint enable	Operating mode dependent (see table below)
7	Reset Fault	only effective with errors
8	Jogging (on/off)	Operating mode dependent (see table below)
9	reserved	—
10	PZD (enable/inhibit)	—
11	Start homing run (edge)	Operating mode dependent (see table below)
12	Manufacturer-specific	reset the position
13	Manufacturer-specific	acknowledge warnings
14	Manufacturer-specific	only position opmode: Bit14 = 1: PZD section is interpreted as direct motion block (velocity 32-bit, position 32-bit, motion block type 16-bit Bit14 = 0: PZD section (HSW) is interpreted as motion block number
15	Manufacturer-specific	Operating mode dependent, digital speed

Depending on the bit combination in the control word, a corresponding control command is defined. The following table shows the bit combinations and also determines the priorities of the individual bits, in case several bits are altered in one telegram cycle.

Command	Bit 13	Bit 7	Bit 4	Bit 3	Bit 2	Bit 1	Bit 0	Transitions
Shutdown	X	X	X	X	1	1	0	2, 6, 8
Switch-on	X	X	X	X	1	1	1	3
Inhibit voltage	X	X	X	X	X	0	X	7, 9, 10, 12
Fast stop (amplifier is disabled)	X	X	X	X	0	1	X	7, 10,11->12
Fast stop (amplifier remains enabled)	X	X	0	1	1	1	1	11
Inhibit operation	X	X	X	0	1	1	1	5
Enable operation	X	X	1	1	1	1	1	4, 16
Reset error	X	1	X	X	X	X	X	15
Acknowledge warnings	1	X	X	X	X	X	X	-

Bits labeled with X are irrelevant.

Opmode-dependent bits in the control word:

Mode	Bit 5	Bit 6	Bit 8	Bit 11
Position	Motion block: The parameter that is set in the motion block is used. Setup operation: The parameter that is set as a ramp for homing and jogging is used	Start a motion task with every transition edge (toggle bit).	Start jogging	Start homing
Digital speed	Drive brakes, using the preset speed ramp.	Setpoint enable, start movement	reserved	reserved
Digital current	reserved	Setpoint enable, start movement	reserved	reserved
Analog speed	reserved	reserved	reserved	reserved
Analog current	reserved	reserved	reserved	reserved
Trajectory	reserved	reserved	reserved	reserved

Priority of the Bits 6, 8, 11 in position-control mode: 6 (high), 11, 8 (low).

5.1.2 Status word (ZSW)

With the help of the status word, the amplifier state can be represented and a transmitted control word can be verified.

If the amplifier does not react to changes of the control word (STW) as expected, the marginal conditions like (enable of the output stage – hardware + software, application of the DC bus link voltage) must be checked.

The bits in the status word can be **mode-dependent** or **mode-independent**.

The following table describes the bit assignment in the status word.

Bit	Name	Commentary
0	Ready for switch-on	---
1	Switched on	---
2	Operation enabled	---
3	Error	see ASCII command ERRCODE
4	Voltage inhibited	---
5	Fast stop	---
6	Switch-on inhibit	---
7	Warning	see ASCII command STATCODE
8	Setpoint / actual value monitoring	only in position-control opmode: following error indicator
9	Remote	not supported, fixed to 1
10	Setpoint reached	only in position mode: In Position
11	Limit active	not supported at present
12	Depends on mode	used in ASCII-mode
13	Depends on mode	used in ASCII-mode
14	Manufacturer-specific	used in ASCII-mode
15	Manufacturer-specific	reserved

States of the status machine:

State	Bit 6	Bit 5	Bit 4	Bit 3	Bit 2	Bit 1	Bit 0
Not ready for switch-on	0	X	X	0	0	0	0
Switch-on inhibit	1	X	X	0	0	0	0
Ready for switch-on	0	1	X	0	0	0	1
Ready for operation	0	1	X	0	0	1	1
Operation enabled	0	1	X	0	1	1	1
Error	0	X	X	1	X	X	X
Error response	0	X	X	1	0	0	0
Fast stop active	0	0	X	0	1	1	1

5.2 Operating modes

The selection of a new operating mode is described in detail on p. 23. This procedure must be followed for proper amplifier operation.

CAUTION

Appropriate precautionary measures against damage caused by faulty presentation of data formats or normalization of the setpoints must be taken by the user.

The possible operating modes are described below. PROFIBUS operating modes with a positive number (1,2) are defined in the drive profile. Operating modes with a negative number (-1,-2...) are labeled in the drive profile as being manufacturer-specific modes.

5.2.1 Positioning (operating mode 2)

Direction	PZD 1	PZD 2	PZD 3	PZD 4	PZD 5	PZD 6
Controller to Amplifier	STW	motion task no. or v_{cmd}^*	-	-	-	-
Amplifier to Controller	ZSW	n_{act} (16-bit)	actual position (32-bit)		manufacturer-specific status	-

*: for jogging/homing

Alternative assignment when STW Bit 14=1 (Direct Motion Task):

Direction	PZD 1	PZD 2	PZD 3	PZD 4	PZD 5	PZD 6
Controller to Amplifier	STW	direct motion task: v_{cmd} (32-bit)		position setpoint (32-bit)		motion block type
Amplifier to Controller	ZSW	n_{act} (16-bit)	actual position (32-bit)		manufacturer-specific status	-

Motion task number

The motion task number of the motion task to be started can lie in the range 1 to 180 (motion tasks in EEPROM) or 192 to 255 (motion tasks in RAM).

Speed Setpoint (v_{cmd})

This is just when jogging or homing is selected. PNU 1894 provide the scaling for this value. See chapter 4.2.4.1 for more detail.

Actual speed (16-bit)

The representation of the 16-bit actual speed value is normalized to the parameter for overspeed $VOSPD$ $n_{act16} = \frac{n_{act}}{VOSPD} \times 2^{15}$

Actual position (32-bit)

The range for the incremental position covers values from -2^{31} to $(2^{31}-1)$, whereby one turn corresponds to 2^{PRBASE} increments. Position is always reported in internal units. Reporting in User Units (SI) is not supported.

Manufacturer-specific status

In the process data, the upper 16 bits of the manufacturer-specific status register (PNU 1002) are made available. The numbering starts again from 0. Details of the status register bits can be found in the table in chapter 4.2.3.3.

Speed setpoint for a direct motion task

The usable range for the speed is not limited by the available data area. It is limited by the maximum achievable speed n_{max} , which is given by the speed parameter VLIM as the final limit speed for the motor. Maximum speed is derived from the following formula:

$$v_{SI,max} = n_{max} \times \frac{PGEARI}{PGEARO} \times 2^{PRBASE} \text{ or, as an incremental value, from:}$$

$$v_{incr,max} = n_{max} \times 2^{PRBASE} \times \frac{250\mu s}{1sec} = \frac{n_{max}}{4000} \times 2^{PRBASE} \text{ , in each case with } n_{max} \text{ in revs/sec}$$

Position setpoint for a direct motion task

The servo amplifier calculates all position values internally on an incremental basis only, so there are limitations on the usable range of values for distances that are given in SI (user) units. The range for the incremental position covers the values from -2^{31} to $(2^{31}-1)$. The resolution that is determined by the PGEARO (PNU1803) and PGEARI (PNU1802) parameters and the variable PRBASE fix the usable range for position values. The variable PRBASE determines, through the equation $n = 2^{PRBASE}$, the number of increments per motor turn. The value of PRBASE can only be 16 or 20. PGEARO contains the number of increments that must be traversed when the distance to be moved is PGEARI. The default values for PGEARO are 1048576 (PRBASE = 20) or 65536 (PRBASE = 16) and correspond to one turn. Number of turns that can be covered : -2048..+2047 for PRBASE=16 and -32768..+32767 for PRBASE=20

The sensibly usable position range is derived as follows:

$$-2^{31} * \frac{PGEARI}{PGEARO} \dots (2^{31} - 1) * \frac{PGEARI}{PGEARO} \quad \text{for } PGEARI \leq PGEARO, \text{ or}$$

$$-2^{31} \dots (2^{31} - 1) \quad \text{for } PGEARI > PGEARO$$

Motion block type

The various types of motion block are described in chapter 4.2.5.3.

5.2.2 Digital speed (operating mode 1)

Direction	PZD 1	PZD 2	PZD 3	PZD 4	PZD 5	PZD 6
Controller to Amplifier	STW	n_{cmd}	-	-	-	-
Amplifier to Controller	ZSW	n_{act}	-	incremental actual position 32-bit	manuf.-specific status	

Alternative assignment of the process data sections with STW Bit 14=1:

Direction	PZD 1	PZD 2	PZD 3	PZD 4	PZD 5	PZD 6
Controller to Amplifier	STW	n_{cmd} (32-bit)	-	-	-	-
Amplifier to Controller	ZSW	n_{act} (32-bit)	-	incremental actual position 32-bit	manuf.-specific status	

Alternative assignment of the process data sections with STW Bit 15=1:

Direction	PZD 1	PZD 2	PZD 3	PZD 4	PZD 5	PZD 6
Controller to Amplifier	STW	n_{cmd}	-	-	-	-
Amplifier to Controller	ZSW	n_{act}	-	position (20 bits/turn and 16 turns)	manuf.-specific status	

Actual speed n_{act} (16-bit)

The representation of the 16-bit actual speed value is normalized to the parameter for the overspeed $VOSPD$ $n_{act16} = \frac{n_{act}}{VOSPD} \times 2^{15}$

Actual position (32-bit)

The range for the incremental position covers values from -2^{31} to $(2^{31}-1)$. Here one turn corresponds to 2^{PRBASE} increments. Reporting the information in User Units (SI) is not supported.

Manufacturer-specific status

In the process data (PZD5), the upper 16 bits of the manufacturer-specific status register (PNU 1002) are made available. The numbering starts again from 0. The significance of the status register bits can be seen in the table in Chapter 4.2.3.3.

Speed setpoint n_{cmd} (16-bit)

The 16-bit speed setpoint is normalized to the parameter for the overspeed $VOSPD$.

$$n_{cmd16} = \frac{n_{cmd}}{VOSPD} \times 2^{15}$$

Position

The actual position value is an incremental value with a resolution of 24 bits. Her one turn corresponds to 2^{PRBASE} increments. So $2^{24 - PRBASE}$ turns can be represented.

Speed values n_{act} (32-bit)

The digital speed values are converted according to the formula.

$$n_{cmd/act} \text{ (in rpm)} = n_{cmd/act, dig.} \times \frac{60 \times 4000}{32 \times 2^{PRBASE} \times 128}$$

with 2^{PRBASE} = Increments per Motor turn, 60s/min,
4000 = Number of position controller cycles / sec.

5.2.3 Analog speed (operating mode -1)

In this operating mode the control word (STW) can only be used to enable and disable the amplifier.

Direction	PZD 1	PZD 2	PZD 3	PZD 4	PZD 5	PZD 6
Controller to Amplifier	STW	-	-	-	-	-
Amplifier to Controller	ZSW	n_{act}	-	incremental actual position 32-bit	manuf.-specific status	

5.2.4 Digital torque (operating mode -2)

Direction	PZD 1	PZD 2	PZD 3	PZD 4	PZD 5	PZD 6
Controller to Amplifier	STW	I_{cmd}	-	-	-	-
Amplifier to Controller	ZSW	I_{act}	incremental actual position (32-bit, value range 24-bit)		manuf.-specific status	-

Actual position (32-bit)

The range for the incremental position covers values from -2^{31} to $(2^{31}-1)$. Here one turn corresponds to 2^{PRBASE} increments.

Manufacturer-specific status

In the process data, the upper 16 bits of the manufacturer-specific status register (PNU 1002) are made available. The numbering starts again from 0. The significance of the status register bits can be seen in the table in Chapter 4.2.3.3.

Digital current values (16-bit)

The digital current values are converted: $I[mA] = \frac{\text{digital current setpoint}}{3280} \times DIPEAK [mA]$
(DIPEAK = amplifier peak current)

5.2.5 Analog torque (operating mode -3)

In this operating mode the control word (STW) can only be used to enable and disable the amplifier.

Direction	PZD 1	PZD 2	PZD 3	PZD 4	PZD 5	PZD 6
Controller to Amplifier	STW	-	-	-	-	-
Amplifier to Controller	ZSW	$I_{act} = IQ$	incremental actual position (32-bit, value range 24-bit)		manuf.-specific status	-

5.2.6 Electronic gearing (operating mode -4)

Direction	PZD 1	PZD 2	PZD 3	PZD 4	PZD 5	PZD 6
Controller to Amplifier	STW	-	-	-	-	-
Amplifier to Controller	ZSW	n_{act}	actual position (32-bit)		manuf. status	-

Actual speed (16-bit)

The representation of the 16-bit actual speed value is normalized to the parameter for the overspeed VOSPD $n_{act16} = \frac{n_{act}}{VOSPD} \times 2^{15}$

Actual position (32-bit)

The range for the actual position covers values from -2^{31} to $(2^{31}-1)$. Here one turn corresponds to 2^{PRBASE} increments.

Manufacturer-specific status

In the process data, the upper 16 bits of the manufacturer-specific status register (PNU 1002) are made available. The numbering starts again from 0. The significance of the status register bits can be seen in the table in Chapter 4.2.3.3.

5.2.7 Trajectory (operating mode -5)

Direction	PZD 1	PZD 2	PZD 3	PZD 4	PZD 5	PZD 6
Controller to Amplifier	STW	-	-	-	-	-
Amplifier to Controller	ZSW	n_{act}	incremental actual position (32-bit)		manuf. status	-

Actual speed (16-bit)

The representation of the 16-bit actual speed value is normalized to the parameter for the overspeed VOSPD $n_{act16} = \frac{n_{act}}{VOSPD} \times 2^{15}$

Actual position (32-bit)

The range for the actual position covers values from -2^{31} to $(2^{31}-1)$. Here one turn corresponds to 2^{PRBASE} increments.

5.2.8 ASCII channel (operating mode -16)

Direction	PZD 1	PZD 2	PZD 3	PZD 4	PZD 5	PZD 6
Controller to Amplifier	STW	10 bytes of ASCII-data				
Amplifier to Controller	ZSW	10 bytes of ASCII-data				

The operating mode "ASCII-channel" is used for parameterizing the servo amplifier.

With this channel, just as with any terminal program, ASCII data can be exchanged with the servo amplifier via the RS232 interface. The control of the communication is performed by handshake bits in the control and status words.

The assignment is as follows:

Bit 12: Control word
Any transition edge on this bit informs the servo amplifier that valid ASCII data are available in its process data input section, i.e. that with effect from this moment valid data must have been entered into the PZD transmission section PZD 2 - PZD 6 by the control system.

Status word

The servo amplifier confirms that it has accepted the ASCII data, by a transition edge on this bit.

Bit 13: Status word
The servo amplifier uses a "1" in this bit to signal that the ASCII buffer now contains valid data. A transition edge of Bit 14 in the control word STW can be used to make the servo amplifier write the buffer contents to the PZD reception section of the bus-master.

Bit 14: Control word
Any transition edge on this bit requests the servo amplifier to write the contents of its filled ASCII buffer to the receive process data of the bus master

Status word

The servo amplifier uses a transition edge on this bit to signal that the ASCII buffer data have been written to the process data.

When transmitting ASCII data, you must observe:

1. Every ASCII command must be terminated by the "CR LF" character sequence.
2. If the ASCII command (with CR LF) is shorter than the 10 characters that are available, then the rest of the telegram must be filled up with bytes with a content 0x00.
3. ASCII commands that are longer than 10 characters must be divided into more than one telegram, whereby a maximum of 30 characters can be sent before the buffer must be read out once.

When evaluating the responses to the transmitted ASCII command, you must observe:

1. The ASCII response is always terminated by an "End of Text" (EOT = 0x04) character.
2. Response telegrams can include less than 10 bytes of user data, without the response being concluded. The telegram must then be filled up with bytes with the value 0x00.
3. After reading out the buffer, Bit 13 of the status word is reset to "0", until the buffer is filled again.
The designation of the end of the ASCII response is in all cases "End of Text".

5.2.9 Operating mode after switch-on (operating mode -126)

In this state, it is possible to control the state machine, but motion functions cannot be initiated (see page 23).

This page is deliberately left blank.

6 Appendix

6.1 Example telegrams

All examples are valid for all servo amplifiers.

6.1.1 Zero telegram (for initialization)

At the beginning of PROFIBUS communication via the parameter channel and after communication errors, a zero telegram should be sent:

Byte 1	2	3	4	5	6	7	8
0000 0000	0000 0000	0000 0000	0000 0000	0000 0000	0000 0000	0000 0000	0000 0000
PKE		IND		PWE			

The servo amplifier answers, by likewise setting the first 8 byte of the telegram (PKW) to zero.

6.1.2 Setting the Opmode

After switch-on or a reset (coldstart) the servo amplifier is in the PROFIBUS operating mode -126, in which it cannot perform any motion functions. For example to carry out positioning operations (motion tasks, jogging, homing), it must be set to the position-control mode.

The procedure to do this is as follows:

- a) Set the control word Bit 10 (PZD1, Bit 10) to 0.
This invalidates the process data for the servo amplifier.

Byte 9	10	11	12
xxxx x0xx	xxxx xxxx	xxxx xxxx	xxxx xxxx
STW		HSW	

- b) Transmit PNU 930 through the parameter channel to set the operating mode.

Byte 1	2	3	4	5	6	7	8
0011 0011	1010 0010	xxxx xxxx	xxxx xxxx	0000 0000	0000 0000	0000 0000	0000 0010
PKE		IND		PWE			

The bits in the PKE section of the PKW have the following significance:

Bit 0 to 10 = PNU 930, Bit 12 to 15 = AK 3 (see also Chapter 3.1.1)

The servo amplifier sends a response telegram with AK = 2 and mirrors (identical) the values for the PNU (parameter number) and PWE (parameter value).

- c) Switch on the new operating mode by setting the control word (STW) Bit 10 to 1.
This validates the process data.

If, for example, point a) is not observed, the servo amplifier transmits a negative answer: (response ID=7)

Byte 1	2	3	4	5	6	7	8
0111 0011	1010 0010	0000 0000	0000 0000	0000 0000	0000 0000	0000 0000	0001 0001
PKE		IND		PWE			

And the number that is transferred in the PWE section represents the error number, and can be looked up in the table in Chapter 3.1.1.2. In this case, error no. 17, "Task impossible because of operating state" will be signaled.

6.1.3 Enable the servo amplifier

The hardware enable signal (24V) must be applied, as a precondition for enabling the servo amplifier via the PROFIBUS. The enable through PROFIBUS can be made by setting the bit combination for the "Operation enabled" state in the control word (STW).

Byte 9	10	11	12
xxx0 x1xx	0011 1111	xxxx xxxx	xxxx xxxx
STW		HSW	

The servo amplifier then reports back the corresponding state in its status word (ZSW), or indicates a warning or error message.

Byte 9	10	11	12
xxxx xx1x	0010 0111	xxxx xxxx	xxxx xxxx
ZSW		HSW	

6.1.4 Start jog mode (on positioning opmode)

Jog mode is started in a similar manner to homing. To start, Bit 8 STW must be set. The jog velocity is given by the product of the 16-bit main setpoint in PZD2 and the multiplier defined by PNU 1894. The sign of the main setpoint determines the direction of movement.

It is not necessary to have a reference point set for jogging.

6.1.5 Set reference point



Take care that the position of the reference point permits the following positioning operations. The parameterized software limit-switches in the servo amplifier may not be effective. The axis could then drive up to the hardware limit-switch or the mechanical stop. There is a danger of damage being caused.

The control word (STW) Bit 12 = 1 defines the present position as being the reference point. The positioning functions are enabled. **The shifting of the zero point (NI-offset) is ineffective.** The replay "Reference point set" is made through Bit 17 in the manufacturer-specific status register (PNU 1002) or Bit 1 (manufacturer status of the process data).

Conditions:

PNU930 ≠ -16

No motion function active manufacturer specific status, process data 5 bit 0

6.1.6 Start homing run

⚠ CAUTION

After switching on the 24V auxiliary voltage the system must first of all carry out a homing run.

Take care that the position of the machine zero point (reference point) permits the following positioning operations. The parameterized software limit-switches in the servo amplifier may not be effective. The axis could then drive up to the hardware limit-switch or the mechanical stop. There is a danger of damage being caused.

If the reference point (machine zero point) is approached too fast, with high moments of inertia in the system, then it might be overrun, and the axis could then drive up to the hardware limit-switch or the mechanical stop. There is a danger of damage being caused.

The homing run is started by the control word (STW) Bit 11 = 1. The start of the homing run is detected by a positive transition edge for Bit 11.

If Bit 11 is set to 0 again, before the reference point has been reached, then the homing run is canceled. Status word (ZSW) Bit 17 remains at 0 (reference point not set).

A set reference point is a precondition for all the positioning functions of the linear axis.

The reference point switch is wired up to a digital input on the servo amplifier.

Depending on the type of homing run, you can freely shift the zero crossing point of the motor shaft within one turn, by using the parameter "Zero-point offset" (NI-offset). Furthermore, you can fix the position value to be the reference point by using the reference offset.

After the homing run, the amplifier signals "InPosition", thereby enabling the position controller.

The velocity for the homing run is transmitted with the setpoint HSW (PZD 2), as a 16-bit value.

Multiplying this by the value of PNU 1894 determines the 32-bit speed. The sign is not evaluated.

Conditions :

State of the state machine = "Operation enabled"

No warning message (ZSW Bit 7 = 0)

The following diagram uses the homing run Type 1 (negative direction of motion, positive rotation, starting point in negative direction relative to the reference switch) as an example to illustrate the signal sequence of the relevant bits in the manufacturer-specific state.

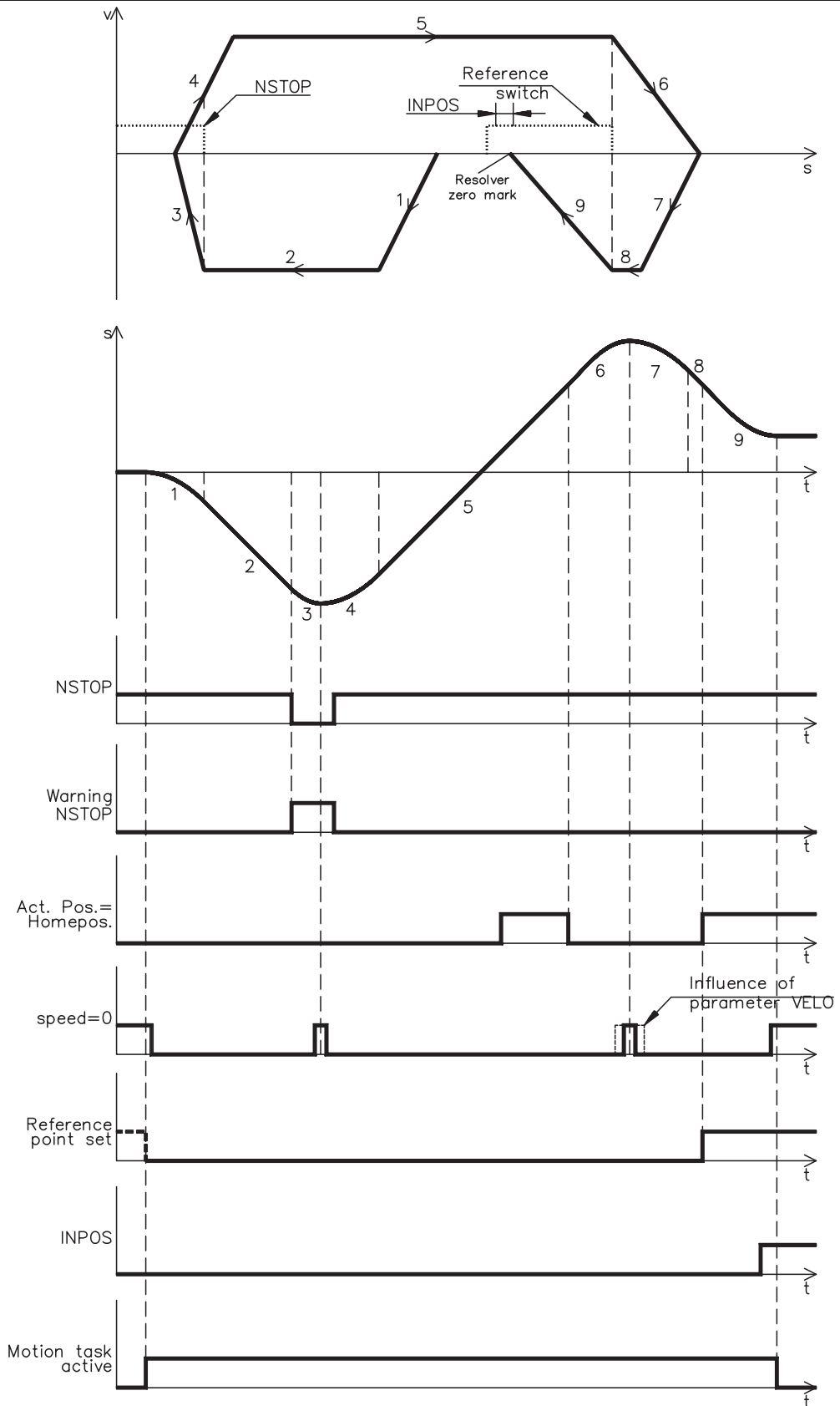

After the homing run has been completed, Bit 11 STW must be set to 0 again.

Alternatively, the reference point can also be set at the actual position.

This can be achieved by setting Bit 12 STW, or by setting the homing run type 0 with PNU 1773 and subsequent start of the homing run by Bit 11 STW .

6.1.7 Start a motion task

Motion tasks are started by a transition edge (positive or negative) at Bit 6 STW. Bit 14 STW is used to decide whether a stored motion task or a direct motion task should be carried out.

Conditions:

- Hardware enable is present.
- Amplifier is in the "Operation enabled" state.
- For linear axis: reference point is set.

Example: start the EEPROM motion task number 10:

Byte 9	10	11	12
0000 0100	0F*11 1111	0000 0000	0000 1010
STW		HSW	

* F stands for a transition edge, the state of Bit 6 STW also depends on the previous state.

By setting bit 5 in the manufacturer-specific status, the amplifier indicates that it has accepted the motion task and is carrying it out.

6.1.8 Start a direct motion task

If the motion task data is to be directly sent from the controller, then a direct motion task must be used. In this case, the target position, velocity and type of motion task are transferred using the process data channel (PZD), together with the call of the motion task. If required, further parameters for this motion task (e.g. ramps) can be transferred previously by parameter tasks.

Target position	135000 μm
Velocity	20000 $\frac{\text{mm}}{\text{s}}$
Motion task type	<ul style="list-style-type: none"> - relative to actual position - with following motion task - without pause - target velocity for the following task should already be reached at the target position (only makes sense if there is no change of direction) - use SI (user) units

Byte 1	2	3	4	5	6
0100 0100	0F*11 1111	0000 0000	0000 0000	0100 1110	0010 0000
PZD1		PZD2		PZD3	
STW		velocity setpoint			

Byte 7	8	9	10	11	12
0000 0000	0000 0010	0000 1111	0101 1000	0010 0001	0001 1101
PZD4		PZD5		PZD6	
position setpoint				motion task type	

* F stands for a transition edge, the state of Bit 6 STW also depends on the previous state.

6.1.9 Polling a warning or error message

If a warning or error message is present, then parameter 1001 or 1002 can be interrogated to find out the number of the warning or error.

6.1.10 Writing a parameter (via parameter channel PKW)

Parameter v_max is used as an example to show how control parameters are transmitted from the master to the servo amplifier.

Parameter number: **1816** 111 0001 1000
 Parameter value: **350000** µm/s 0000 0000 0000 0101 0101 0111 0011 0000

Byte 1	2	3	4	5	6	7	8
0011 0111	0001 1000	0000 0100	0000 0000	0000 0000	0000 0101	0101 0111	0011 0000
PKE		IND		PWE			

Note: after an error has occurred in parameter transmission (AK = 7), a "Zero telegram" should be transmitted, i.e. the first 8 bytes of the transmit telegram from the PLC should be kept at 0, until the servo amplifier has responded with a zero telegram.

6.1.11 Reading actual values

Cyclical actual value request

This PKW task switches on the reading of an actual value. The actual value will now be transmitted with each cyclical telegram – until a new PKW task is presented.

Telegram layout:

	Request	Response
PKE/AK	1	2
PKE/PNU	Parameter number of the actual values	as transmitted
IND	0 = read	0
PWE	no significance	actual value

6.1.12 Write a parameter via the ASCII channel

The KP value for the current controller is to be set through the ASCII channel. The command is then `MLGQ_1.985`. Here the understroke stands for a space. Since every telegram only has 10 positions available for the transmission of ASCII characters, the termination of the line ("CR LF") must be transmitted in a second telegram.

Conditions:

ASCII mode is switched on (PNU 930 = -16)

Bit 13 STW = 0 (if necessary, toggle Bit 14 STW until Bit 13 ZSW = 0)

Procedure:

1. Write data to PZD 2..6 and invert Bit 12 STW

Byte 1	2	3	4	5	6
0001 0000	0000 0000	0100 1101	0100 1100	0100 0111	0101 0001
PZD1		PZD2		PZD3	
STW		"M"	"L"	"G"	"Q"

Byte 7	8	9	10	11	12
0010 0000	0011 0001	0010 1110	0011 1001	0011 1000	0011 0101
PZD4		PZD5		PZD6	
"_"	"1"	"."	"9"	"8"	"5"

2. Wait for the transition edge on Bit 12 ZSW
3. Continue writing data to PZD 2..6 and invert Bit 12 STW

Byte 1	2	3	4	5..12
0000 0000	0000 0000	0000 1101	0000 1010	0000 0000
PZD1		PZD2		PZD3..6
STW		"CR"	"LF"	

4. Wait for the transition edge on Bit 12 ZSW
5. Wait until Bit 13 ZSW = 1
6. Invert Bit 14 STW
7. Wait until Bit 14 ZSW = 1
8. The servo amplifier sends a response telegram

Byte 1	2	3	4	5	6
0110 0010	0000 0000	0100 1101	0100 1100	0100 0111	0101 0001
PZD1		PZD2		PZD3	
ZSW		"M"	"L"	"G"	"Q"

Byte 7	8	9	10	11	12
0010 0000	0011 0001	0010 1110	0011 1001	0011 1000	0011 0101
PZD4		PZD5		PZD6	
"_"	"1"	"."	"9"	"8"	"5"

9. Repeat steps 5 to 8 until a response telegram indicates "EOT".

Byte 1	2	3	4	5	6	7..12
0000 0010	0000 0000	0000 1101	0000 1010	0000 0100	0000 0000	0000 0000
PZD1		PZD2		PZD3		PZD4..6
ZSW		"CR"	"LF"	"EOT"		

Note: The sequence of response telegrams shown above is only one of many possibilities (for the same response from the servo amplifier). Because of the transmission rate and the internal synchronization mechanism, it can happen that process data sections remain empty and so the response is broken into segments. This could possibly alter the number of response telegrams.

6.2 Index

A	abbreviations	6	M	motion task	
	acceleration time	27		copy	28
	actual position value			start	47
	incremental	29		type	27
	SI-units	29	N	next motion task	28
	analog inputs	30	O	operating modes	37
	analog outputs	30	P	parameter channel	16
	axis type	26		parameter description	22
B	baud rate	22		parameter ID	16
C	complete documentation	5		parameter numbers	20
	Connection diagram PROFIBUS	9		parameter value	18
	control word	36		parameterization of the amplifier	18
D	data format, parameter	18		PNU list	20
	deceleration time	28		position data	26
	default parameters	22		process data channel	18
	digital inputs	30		PROFIDRIVE profile number	22
	digital outputs	30	R	read actual values	48
E	error numbers	17		read/write amplifier parameter	19
	error register	24		response IDs	16
F	Fitting the expansion card	8	S	sample telegram	43
H	homing	45		saving	22
	homing direction	29		set reference point	44
	homing type	29		Setup	11
I	incremental position	26		Setup software	13
	Index IND	17		speed	29
	installation	7		standard function blocks	11
	instrument control	34		start delay	28
	instrument ID	24		status machine	34
	instrument profile	15		status register	25
	interface modules	10		status word	37
J	jog mode	44	T	Target group	5
	jolt limiting		U	Use as directed	6
	acceleration	28	V	velocity	26
	deceleration	28		velocity multiplier	26

This page has been deliberately left blank.

Service

We are committed to quality customer service. In order to serve in the most effective way, please contact your local sales representative for assistance.
If you are unaware of your local sales representative, please contact the Customer Support.

Europa

Kollmorgen Customer Support Europe

Internet www.kollmorgen.com

E-Mail technik@kollmorgen.com

Tel.: +49 (0)2102 - 9394 - 2250

Fax: +49 (0)2102 - 9394 - 3110

North America

Kollmorgen Customer Support North America

Internet www.kollmorgen.com

E-Mail support@kollmorgen.com

Tel.: +1 - 540 - 633 - 3545

Fax: +1 - 540 - 639 - 4162