

AKD BASIC®

Programming Manual



```

X = 0
MOVE.ACC = 1
MOVE.DEC = 1

INPUT "ENTER RUNSPEED"; MOVE.RUNSPEED
IF MOVE.RUNSPEED > 50 AND MOVE.RUNSPEED < 100 THEN
    MOVE.ACC = MOVE.RUNSPEED * 0.5
    MOVE.DEC = MOVE.ACC * 2
ELSEIF MOVE.RUNSPEED > 100 AND MOVE.RUNSPEED < 500 THEN
    MOVE.ACC = MOVE.RUNSPEED * .25
    MOVE.DEC = MOVE.ACC * 4
    IF MOVE.ACC < 75 THEN
        OUT1 = 0
        X = 1.5
    ELSE
        OUT1 = 1
        X = 1
    END IF
ELSEIF MOVE.RUNSPEED > 500 AND MOVE.RUNSPEED < 1500 THEN
    MOVE.ACC = MOVE.RUNSPEED * 1.5
    MOVE.DEC = ACCELRA T E * 8
ELSE
    PRINT "VALUES OUT OF RANGE"
END IF
    
```

Edition May 2014, Revision G

Valid for Firmware Revision 1.12

Part Number 903-2000017-00



Keep all manuals as a product component during the life span of the product.
Pass all manuals to future users/owners of the product.

KOLLMORGEN®

Because Motion Matters™

Record of Document Revisions:

Revision	Remarks
06/2011, Rev A	Launch Version for M_01-06-00-000
05/2012, Rev B	Updated for BASIC IO option card. Option IO parameters in SD, AIN2, AOUT2, DIN, and DOUT parameter categories added.
12/2012, Rev C	Added Appendix A: BASIC Sample Programs. Ranges and default values updated for EGEAR and MOVE parameters.
05/2013, Rev D	Added VM parameters. Updated CAM.CREATE example.
09/2013, Rev E	Feedback type "none" added. Capture Feedback Source added. Parameters added: GUI.DISPLAYS (pg 1), TEMP.POWER1 to TEMP.POWER3, DRV.DOWNLOADALLOWED. Variant support information added to all parameters.
12/2013, Rev F	Program Memory Space (pg 26) added. DRV.MOTIONDISSOURCES (pg 361), FB1.LASTIDENTIFIED (pg 421), VL.VFTHRESH (pg 770) added. MOTOR.IDMAX, MOTOR.LDLL, MOTOR.LISAT, MOTOR.PHSADV1, MOTOR.PHSADV2, MOTOR.SUPPORTEDPARAMS, MOTOR.TEMPC added (see MOTOR Parameters (pg 546)).
05/2014, Rev G	MOTORPHASE and MOTORPOLES parameters added to FB1 Parameters (→ p. 1), FB2 Parameters (pg 450), and FB3 Parameters (pg 460). FB3.DIR (pg 461) added. Program Memory Space (pg 26) section added.

Windows is a registered trademark of Microsoft Corporation

AKD is a registered trademark of Kollmorgen Corporation

Current patents:

US Patent 5,646,496 (used in control card R/D and 1 Vp-p feedback interface)

US Patent 5,162,798 (used in control card R/D)

US Patent 6,118,241 (used in control card simple dynamic braking)

Technical changes which improve the performance of the device may be made without prior notice.

Printed in the United States of America

This document is the intellectual property of Kollmorgen. All rights reserved. No part of this work may be reproduced in any form (by photocopying, microfilm or any other method) or stored, processed, copied or distributed by electronic means without the written permission of Kollmorgen.

Table of Contents

1 About this User Guide	19
2 Program View	20
2.1 Toolbar Options	20
2.1.1 New	20
2.1.2 Save / Save As	20
2.1.3 Open	21
2.1.4 Edit Parameters Section	21
2.1.5 Compile / Download / Run	21
2.1.6 Continue / Pause / Stop	21
2.1.7 Debug	21
2.1.8 View	22
2.1.9 Format Document	22
2.1.10 Insert Code Snippet	22
2.1.11 Upload?	22
2.1.12 Lock	22
2.2 Incompatible Firmware	23
2.2.1 Resolving Incompatible Firmware	23
2.3 Unsupported Parameters	23
3 AKD BASIC Language	25
3.1 AKD BASIC Program Structure	25
3.1.1 Local Variables	25
3.1.2 Global Variables	25
3.2 Program Memory Space	26
3.3 Program Sections	26
3.3.1 Program Template	26
3.3.2 Setup Parameter Definitions	27
3.3.3 Global Variables, Constants, and Aliases	27
3.3.4 Variable Definitions	27
3.3.5 Constant Definitions	28
3.3.6 Alias Definitions	28
3.4 Main Program, Subroutines, Functions & Interrupt Handlers	28
3.4.1 Main Definitions	29
3.4.2 Subroutine Definition	30
3.4.3 Function Definition	30
3.4.4 Interrupt Handler Definition	30
3.5 Language Definition	31
3.5.1 Lexical Conventions	31
3.5.2 Identifiers	31
3.5.3 Data Types	31
3.5.4 Literal Constants	32
3.5.5 Decimal Integer Constants	32
3.5.6 Hexadecimal Constants	32
3.5.7 Floating-Point Constants	33
3.6 Statements	33

3.6.1 Alias	33
3.6.2 Call	33
3.6.3 CIs	33
3.6.4 Const	34
3.6.5 Dim	34
3.6.6 Exit	34
3.6.7 For...Next	34
3.6.8 Function	35
3.6.9 GoTo	35
3.6.10 If...Then...Else	36
3.6.11 \$Include	36
3.6.12 Input	36
3.6.13 Interrupt ... End Interrupt	36
3.6.14 MOVE.ABORT	36
3.6.15 MOVE.GOABS	36
3.6.16 MOVE.GOHOME	37
3.6.17 MOVE.GOREL	37
3.6.18 MOVE.GOUPDATE	37
3.6.19 MOVE.GOVEL	37
3.6.20 On Error GoTo	37
3.6.21 Pause()	38
3.6.22 Print	38
3.6.23 VM.RESTART	38
3.6.24 Select Case	38
3.6.25 Static	39
3.6.26 Stop	39
3.6.27 Sub...End Sub	39
3.6.28 Swap	40
3.6.29 When	40
3.6.30 While...Wend	40
3.7 Built-in Functions	40
3.7.1 Parameters and Commands	42
3.8 Expressions	42
3.8.1 Arithmetic Expressions	42
3.8.2 Numeric Operators	42
3.8.3 Logical Operators	42
3.8.4 String Operators	43
3.8.5 Example	43
3.9 Function Invocation	43
3.9.1 \$INCLUDE	44
3.10 Arrays and Function Parameter Lists	44
3.10.1 Optimizations	45
3.11 AKD BASICModBus TCP/IP	46
3.11.1 ModBus Parameter Table	46
3.11.2 ModBus Register and Data Types	46

3.11.3 User Created Variables with Assigned Modbus Address Numbers	47
3.11.4 Drive Fault Table	47
3.11.5 Drive Parameter Scaling Over Modbus	47
3.11.6 Special Modbus AKD Parameters	47
3.11.7 ModBus Dynamic Mapping	48
3.12 Cam Profiling	48
3.12.1 Procedure	48
3.12.2 Related Variables	49
3.12.3 Cam Wizard	49
3.12.4 Example	50
3.12.5 Program	50
3.12.6 Virtual encoder (virtual master)	51
3.12.7 Move Parameters	51
3.12.8 Move Statements	52
3.12.9 Other Variables for Virtual Encoder	52
4 Quick Reference: Parameters, Functions, Operators	53
4.1 AKD Parameters and Commands	53
4.2 AKD BASIC Parameters and Commands	63
5 AKD BASIC Functions	71
5.1 ABS()	72
5.2 ASC()	73
5.3 ATAN()	74
5.4 CHR\$()	75
5.5 CINT()	76
5.6 COS()	77
5.7 EXP()	78
5.8 FIX()	79
5.9 HEX\$()	80
5.10 INKEY\$()	81
5.11 INSTR()	82
5.12 INT()	83
5.13 LCASE\$()	84
5.14 LEFT\$()	85
5.15 LEN()	86
5.16 LOG()	87
5.17 LOG10()	88
5.18 LTRIM\$()	89
5.19 MID\$	90
5.20 OCT\$()	91
5.21 RIGHT\$()	92
5.22 RTRIM\$()	93
5.23 SGN()	94
5.24 SIN()	95
5.25 SPACE\$()	96
5.26 SQRT()	97

5.27	STR\$()	98
5.28	STRING\$()	99
5.29	TAN()	100
5.30	TRIM\$()	101
5.31	UCASE\$()	102
5.32	VAL()	103
6	Operators	104
6.1	AND	105
6.2	BAND	106
6.3	BNOT	107
6.4	BOR	108
6.5	BXOR	109
6.6	MOD	110
6.7	NOT	111
6.8	OR	112
6.9	SHL	113
6.10	SHRA	114
6.11	SHRL	115
6.12	XOR	116
7	AKD BASIC Parameters and Statements	117
7.1	Additional Statements	118
7.1.1	\$Include	119
7.1.2	Alias	120
7.1.3	Call	121
7.1.4	Cls	122
7.1.5	Const	123
7.1.6	Dim	124
7.1.7	Exit	125
7.1.8	For...Next	126
7.1.9	Function	127
7.1.10	GoTo	128
7.1.11	If...Then...Else	129
7.1.12	Input	130
7.1.13	On Error GoTo	131
7.1.14	Pause()	132
7.1.15	Print	133
7.1.16	Restart	134
7.1.17	Select Case	135
7.1.18	Static	136
7.1.19	Stop	137
7.1.20	Sub...End Sub	138
7.1.21	Swap	139
7.1.22	While...Wend	140
7.2	AIN Parameters	141
7.2.1	AIN.CUTOFF	142

7.2.2 AIN.DEADBAND	143
7.2.3 AIN.DEADBANDMODE	145
7.2.4 AIN.ISCALE	147
7.2.5 AIN.MODE	148
7.2.6 AIN.OFFSET	150
7.2.7 AIN.PSCALE	151
7.2.8 AIN.VALUE	153
7.2.9 AIN.VSCALE	154
7.2.10 AIN.ZERO	156
7.3 AIN2 Parameters	157
7.3.1 AIN2.CUTOFF	158
7.3.2 AIN2.DEADBAND	159
7.3.3 AIN2.DEADBANDMODE	160
7.3.4 AIN2.MODE	161
7.3.5 AIN2.OFFSET	162
7.3.6 AIN2.VALUE	163
7.3.7 AIN2.ZERO	164
7.4 AOUT Parameters	165
7.4.1 AOUT.CUTOFF	166
7.4.2 AOUT.DEBUGADDR	167
7.4.3 AOUT.DEBUGDATATYPE	168
7.4.4 AOUT.DEBUGSCALE	169
7.4.5 AOUT.ISCALE	170
7.4.6 AOUT.MODE	171
7.4.7 AOUT.OFFSET	173
7.4.8 AOUT.PSCALE	174
7.4.9 AOUT.VALUE	176
7.4.10 AOUT.VALUEU	177
7.4.11 AOUT.VSCALE	178
7.5 AOUT2 Parameters	180
7.5.1 AOUT2.CUTOFF	181
7.5.2 AOUT2.MODE	182
7.5.3 AOUT2.OFFSET	183
7.5.4 AOUT2.VALUE	184
7.5.5 AOUT2.VALUEU	185
7.6 BODE Parameters	186
7.6.1 BODE.EXCITEGAP	187
7.6.2 BODE.FREQ	188
7.6.3 BODE.IAMP	190
7.6.4 BODE.IFLIMIT	191
7.6.5 BODE.IFTHRESH	193
7.6.6 BODE.INJECTPOINT	195
7.6.7 BODE.MODE	197
7.6.8 BODE.MODETIMER	200
7.6.9 BODE.PRBDDEPTH	202

7.6.10 BODE.VAMP	203
7.6.11 BODE.VFLIMIT	205
7.6.12 BODE.VFTHRESH	207
7.7 CAM Parameters	209
7.7.1 CAM.ACTIVATE	210
7.7.2 CAM.ADDPOINT	212
7.7.3 CAM.CORRECTDIR	214
7.7.4 CAM.CREATE	215
7.7.5 CAM.MASTER	217
7.7.6 CAM.MASTERPOS	218
7.7.7 CAM.SLAVEOFFSET	219
7.7.8 CAMVM.DIR	220
7.7.9 CAMVM.FREQ	221
7.7.10 CAMVM.GOREL	222
7.7.11 CAMVM.GOUPDATE	223
7.7.12 CAMVM.GOVEL	224
7.7.13 CAMVM.MOVING	225
7.7.14 CAMVM.POSITION	226
7.7.15 CAMVM.RELATIVEDIST	227
7.7.16 CAMVM.STOP	228
7.8 CAP Parameters	229
7.8.1 CAP0.EDGE, CAP1.EDGE	230
7.8.2 CAP0.EN, CAP1.EN	232
7.8.3 CAP0.EVENT, CAP1.EVENT	233
7.8.4 CAP0.FBSOURCE, CAP1.FBSOURCE	236
7.8.5 CAP0.FILTER, CAP1.FILTER	237
7.8.6 CAP0.MODE, CAP1.MODE	238
7.8.7 CAP0.PLFB, CAP1.PLFB	240
7.8.8 CAP0.PREEDGE, CAP1.PREEDGE	242
7.8.9 CAP0.PREFILTER, CAP1.PREFILTER	244
7.8.10 CAP0.PRESELECT, CAP1.PRESELECT	245
7.8.11 CAP0.STATE, CAP1.STATE	247
7.8.12 CAP0.T, CAP1.T	248
7.8.13 CAP0.TRIGGER, CAP1.TRIGGER	250
7.9 CS Parameters	252
7.9.1 CS.DEC	253
7.9.2 CS.STATE	255
7.9.3 CS.TO	256
7.9.4 CS.VTHRESH	258
7.10 DIN Parameters	260
7.10.1 DIN.HCMD1 TO DIN.HCMD4	262
7.10.2 DIN.LCMD1 to DIN.LCMD4	264
7.10.3 DIN.ROTARY	265
7.10.4 DIN.STATES	267
7.10.5 DIN1.FILTER TO DIN7.FILTER	268

7.10.6 DIN1.INV to DIN7.INV	270
7.10.7 DIN1.MODE TO DIN7.MODE	272
7.10.8 DIN1.STATE TO DIN7.STATE	274
7.10.9 DIN9.STATE to DIN11.STATE	276
7.10.10 DIN21.FILTER to DIN32.FILTER	277
7.10.11 DIN21.STATE to DIN32.STATE	279
7.11 DIO Parameters	281
7.11.1 DIO9.DIR to DIO11.DIR	282
7.11.2 DIO9.INV to DIO11.INV	283
7.12 DOUT Parameters	284
7.12.1 DOUT.CTRL	285
7.12.2 DOUT.RELAYMODE	286
7.12.3 DOUT.STATES	287
7.12.4 DOUT1.MODE to DOUT2.MODE	288
7.12.5 DOUT1.PARAM AND DOUT2.PARAM	290
7.12.6 DOUT1.STATE AND DOUT2.STATE	292
7.12.7 DOUT1.STATEU AND DOUT2.STATEU	293
7.12.8 DOUT9.STATE to DOUT11.STATE	294
7.12.9 DOUT9.STATEU to DOUT11.STATEU	295
7.12.10 DOUT21.STATE to DOUT32.STATE	297
7.12.11 DOUT21.STATEU to DOUT32.STATEU	299
7.13 DRV Parameters	301
7.13.1 DRV.ACC	303
7.13.2 DRV.ACTIVE	305
7.13.3 DRV.BLINKDISPLAY	306
7.13.4 DRV.BOOTTIME	307
7.13.5 DRV.CLRASHDUMP	308
7.13.6 DRV.CLRFAULTHIST	309
7.13.7 DRV.CLRFAULTS	310
7.13.8 DRV.CMDDELAY	311
7.13.9 DRV.CMDSOURCE	312
7.13.10 DRV.CRASHDUMP	314
7.13.11 DRV.DBILIMIT	315
7.13.12 DRV.DEC	316
7.13.13 DRV.DIFVAR	318
7.13.14 DRV.DIR	319
7.13.15 DRV.DIS	320
7.13.16 DRV.DISMEDIA	321
7.13.17 DRV.DISSOURCES	323
7.13.18 DRV.DISTO	325
7.13.19 DRV.EMUCHECKSPEED	326
7.13.20 DRV.EMUEDIR	327
7.13.21 DRV.EMUEMODE	328
7.13.22 DRV.EMUEMTURN	330
7.13.23 DRV.EMUEPULSEWIDTH	332

7.13.24 DRV.EMUERES	334
7.13.25 DRV.EMUEZOFFSET	335
7.13.26 DRV.EN	337
7.13.27 DRV.ENDEFAULT	338
7.13.28 DRV.FAULTHIST	339
7.13.29 DRV.FAULTS	340
7.13.30 DRV.FAULT1 to DRV.FAULT10	341
7.13.31 DRV.HANDWHEEL	343
7.13.32 DRV.HANDWHEELSRC	345
7.13.33 DRV.HELP	346
7.13.34 DRV.HELPALL	347
7.13.35 DRV.HWENABLE	348
7.13.36 DRV.HWENDELAY	349
7.13.37 DRV.HWENMODE	350
7.13.38 DRV.ICONT	351
7.13.39 DRV.INFO	352
7.13.40 DRV.IPEAK	355
7.13.41 DRV.IZERO	356
7.13.42 DRV.LIST	357
7.13.43 DRV.LOGICVOLTS	358
7.13.44 DRV.MEMADDR	359
7.13.45 DRV.MEMDATA	360
7.13.46 DRV.MOTIONDISSOURCES	361
7.13.47 DRV.MOTIONSTAT	362
7.13.48 DRV.NAME	364
7.13.49 DRV.NVCHECK	365
7.13.50 DRV.NVLIST	366
7.13.51 DRV.NVLOAD	367
7.13.52 DRV.NVSAVE	368
7.13.53 DRV.ONTIME	369
7.13.54 DRV.OPMODE	370
7.13.55 DRV.READFORMAT	372
7.13.56 DRV.RSTVAR	373
7.13.57 DRV.RUNTIME	374
7.13.58 DRV.SETUPREQBITS	375
7.13.59 DRV.SETUPREQLIST	377
7.13.60 DRV.STOP	378
7.13.61 DRV.SWENABLE	379
7.13.62 DRV.TEMPERATURES	380
7.13.63 DRV.TIME	381
7.13.64 DRV.TYPE	382
7.13.65 DRV.VER	384
7.13.66 DRV.VERIMAGE	385
7.13.67 DRV.WARNINGS	386
7.13.68 DRV.WARNING1 to DRV.WARNING3	387

7.13.69 DRV.ZERO	389
7.14 EGEAR Parameters	390
7.14.1 EGEAR.ACCLIMIT	391
7.14.2 EGEAR.DECLIMIT	393
7.14.3 EGEAR.ERROR	395
7.14.4 EGEAR.LOCK	396
7.14.5 EGEAR.ON	397
7.14.6 EGEAR.PULSESIN	398
7.14.7 EGEAR.PULSESOUT	399
7.14.8 EGEAR.RATIO	400
7.14.9 EGEAR.TYPE	401
7.15 EXTENCODER Parameters	402
7.15.1 EXTENCODER.FREQ	403
7.15.2 EXTENCODER.POSITION	404
7.15.3 EXTENCODER.POSMODULO	405
7.16 FAULT Parameters	406
7.16.1 FAULTx.ACTION	407
7.17 FB1 Parameters	409
7.17.1 FB1.BISSBITS	410
7.17.2 FB1.ENCRESES	411
7.17.3 FB1.HALLSTATE	413
7.17.4 FB1.HALLSTATEU	415
7.17.5 FB1.HALLSTATEV	416
7.17.6 FB1.HALLSTATEW	417
7.17.7 FB1.IDENTIFIED	418
7.17.8 FB1.INITSIGNED	420
7.17.9 FB1.LASTIDENTIFIED	421
7.17.10 FB1.MECHPOS	422
7.17.11 FB1.MEMVER	423
7.17.12 FB1.MOTORPHASE	424
7.17.13 FB1.MOTORPOLES	425
7.17.14 FB1.OFFSET	426
7.17.15 FB1.ORIGIN	428
7.17.16 FB1.P	430
7.17.17 FB1.PDIR	431
7.17.18 FB1.PFIND	432
7.17.19 FB1.PFINDCMDU	433
7.17.20 FB1.POFFSET	434
7.17.21 FB1.POLES	435
7.17.22 FB1.PSCALE	436
7.17.23 FB1.PUNIT	438
7.17.24 FB1.RESKTR	439
7.17.25 FB1.RESREFPHASE	440
7.17.26 FB1.SELECT	441
7.17.27 FB1.TRACKINGCAL	443

7.17.28 FB1.USERBYTE0 to FB1.USERBYTE7	444
7.17.29 FB1.USERDWORD0 to FB1.USERDWORD1	446
7.17.30 FB1.USERWORD0 to FB1.USERWORD3	448
7.18 FB2 Parameters	450
7.18.1 FB2.ENCRESES	451
7.18.2 FB2.MODE	452
7.18.3 FB2.MOTORPHASE	453
7.18.4 FB2.MOTORPOLES	454
7.18.5 FB2.P	455
7.18.6 FB2.DIR	456
7.18.7 FB2.POFFSET	457
7.18.8 FB2.PUNIT	458
7.18.9 FB2.SOURCE	459
7.19 FB3 Parameters	460
7.19.1 FB3.DIR	461
7.19.2 FB3.MODE	462
7.19.3 FB3.MOTORPHASE	463
7.19.4 FB3.MOTORPOLES	464
7.19.5 FB3.P	465
7.19.6 FB3.PDIR	466
7.19.7 FB3.POFFSET	467
7.19.8 FB3.PUNIT	468
7.20 GUI Parameters	469
7.20.1 GUI.DISPLAY	470
7.20.2 GUI.PARAM01	471
7.20.3 GUI.PARAM02	472
7.20.4 GUI.PARAM03	473
7.20.5 GUI.PARAM04	474
7.20.6 GUI.PARAM05	475
7.20.7 GUI.PARAM06	476
7.20.8 GUI.PARAM07	477
7.20.9 GUI.PARAM08	478
7.20.10 GUI.PARAM09	479
7.20.11 GUI.PARAM10	480
7.21 HWLS Parameters	481
7.21.1 HWLS.NEGSTATE	482
7.21.2 HWLS.POSSTATE	483
7.22 IL Parameters	484
7.22.1 IL.BUSFF	485
7.22.2 IL.CMD	486
7.22.3 IL.CMDU	487
7.22.4 IL.DFOLDT	488
7.22.5 IL.DIFOLD	489
7.22.6 IL.FB	490
7.22.7 IL.FF	491

7.22.8 IL.FOLDFTHRESH	492
7.22.9 IL.FOLDFTHRESHU	493
7.22.10 IL.FOLDWTHRESH	494
7.22.11 IL.FRCTION	495
7.22.12 IL.IFOLD	496
7.22.13 IL.IUFB	497
7.22.14 IL.IVFB	498
7.22.15 IL.KACFF	499
7.22.16 IL.KBUSFF	500
7.22.17 IL.KP	501
7.22.18 IL.KPDRATIO	502
7.22.19 IL.KPLOOKUPINDEX	503
7.22.20 IL.KPLOOKUPVALUE	504
7.22.21 IL.KPLOOKUPVALUES	506
7.22.22 IL.KVFF	507
7.22.23 IL.LIMITN	508
7.22.24 IL.LIMITP	509
7.22.25 IL.MFOLDD	510
7.22.26 IL.MFOLDR	511
7.22.27 IL.MFOLDT	512
7.22.28 IL.MI2T	513
7.22.29 IL.MI2TWTHRESH	514
7.22.30 IL.MIFOLD	515
7.22.31 IL.MIMODE	516
7.22.32 IL.OFFSET	517
7.22.33 IL.VCMD	518
7.22.34 IL.VUFB	519
7.22.35 IL.VVFB	520
7.23 IP Parameters	521
7.23.1 IP.ADDRESS	522
7.23.2 IP.GATEWAY	524
7.23.3 IP.MODE	526
7.23.4 IP.RESET	528
7.23.5 IP.SUBNET	530
7.24 INTR Parameters	532
7.24.1 Interrupt {Source}	533
7.24.2 Interrupt...End Interrupt	535
7.25 LOAD-Parameter	536
7.25.1 LOAD.INERTIA	537
7.26 MODBUS Paramters	538
7.26.1 MODBUS.PIN	539
7.26.2 MODBUS.POUT	541
7.26.3 MODBUS.PSCALE	543
7.26.4 MODBUS.SCALING	545
7.27 MOTOR Parameters	546

7.27.1 MOTOR.AUTASET	548
7.27.2 MOTOR.BRAKE	550
7.27.3 MOTOR.BRAKEIMM	552
7.27.4 MOTOR.BRAKERLS	553
7.27.5 MOTOR.BRAKESTATE	554
7.27.6 MOTOR.CTF0	555
7.27.7 MOTOR.ICONT	556
7.27.8 MOTOR.IDDATAVALID	557
7.27.9 MOTOR.IDMAX	558
7.27.10 MOTOR.INERTIA	559
7.27.11 MOTOR.IPEAK	560
7.27.12 MOTOR.KE	561
7.27.13 MOTOR.KT	562
7.27.14 MOTOR.LDLL	563
7.27.15 MOTOR.LISAT	564
7.27.16 MOTOR.LQLL	565
7.27.17 MOTOR.NAME	566
7.27.18 MOTOR.PHASE	567
7.27.19 MOTOR.PHSADV1	568
7.27.20 MOTOR.PHSADV2	569
7.27.21 MOTOR.PITCH	570
7.27.22 MOTOR.POLES	571
7.27.23 MOTOR.R	572
7.27.24 MOTOR.SUPPORTEDPARAMS	573
7.27.25 MOTOR.TBRAKEAPP	574
7.27.26 MOTOR.TBRAKERLS	575
7.27.27 MOTOR.TBRAKETO	576
7.27.28 MOTOR.TEMP	577
7.27.29 MOTOR.TEMPC	578
7.27.30 MOTOR.TEMPFAULT	579
7.27.31 MOTOR.TEMPWARN	580
7.27.32 MOTOR.TYPE	581
7.27.33 MOTOR.VMAX	583
7.27.34 MOTOR.VOLTMAX	584
7.27.35 MOTOR.VOLTMIN	585
7.27.36 MOTOR.VOLTRATED	586
7.27.37 MOTOR.VRATED	587
7.28 MOVE Parameters	589
7.28.1 MOVE.ABORT	590
7.28.2 MOVE.ACC	591
7.28.3 MOVE.DEC	593
7.28.4 MOVE.DIR	595
7.28.5 MOVE.DWELLTIME	596
7.28.6 MOVE.GOABS	597
7.28.7 MOVE.GOHOME	598

7.28.8 MOVE.GOREL	599
7.28.9 MOVE.GOUPDATE	600
7.28.10 MOVE.GOVEL	601
7.28.11 MOVE.INPOSITION	602
7.28.12 MOVE.INPOSLIMIT	603
7.28.13 MOVE.MOVING	604
7.28.14 MOVE.POSCOMMAND	605
7.28.15 MOVE.RELATIVEDIST	606
7.28.16 MOVE.RUNSPEED	607
7.28.17 MOVE.SCURVETIME	608
7.28.18 MOVE.TARGETPOS	609
7.28.19 MOVE.VCMD	610
7.29 PL Parameters	611
7.29.1 PL.CMD	612
7.29.2 PL.ERR	613
7.29.3 PL.ERRFTHRESH	615
7.29.4 PL.ERRMODE	617
7.29.5 PL.ERRWTHRESH	619
7.29.6 PL.FB	621
7.29.7 PL.FBSOURCE	623
7.29.8 PL.INTINMAX	624
7.29.9 PL.INTOUTMAX	626
7.29.10 PL.KI	628
7.29.11 PL.KP	629
7.29.12 PL.MODP1	630
7.29.13 PL.MODP2	632
7.29.14 PL.MODPDIR	634
7.29.15 PL.MODPEN	636
7.30 PLS Parameters	638
7.30.1 PLS.EN	639
7.30.2 PLS.MODE	641
7.30.3 PLS.P1 TO PLS.P8	643
7.30.4 PLS.RESET	645
7.30.5 PLS.STATE	647
7.30.6 PLS.T1 TO PLS.T8	649
7.30.7 PLS.UNITS	651
7.30.8 PLS.WIDTH1 TO PLS.WIDTH8	654
7.31 REC Parameters	656
7.31.1 REC.ACTIVE	657
7.31.2 REC.CH1 to REC.CH6	658
7.31.3 REC.DONE	659
7.31.4 REC.GAP	660
7.31.5 REC.NUMPOINTS	661
7.31.6 REC.OFF	662
7.31.7 REC.RECPRMLIST	663

7.31.8 REC.RETRIEVE	664
7.31.9 REC.RETRIEVEDATA	665
7.31.10 REC.RETRIEVEFRMT	667
7.31.11 REC.RETRIEVEHDR	668
7.31.12 REC.RETRIEVESIZE	669
7.31.13 REC.STOPTYPE	670
7.31.14 REC.TRIG	671
7.31.15 REC.TRIGPARAM	672
7.31.16 REC.TRIGPOS	673
7.31.17 REC.TRIGPRMLIST	675
7.31.18 REC.TRIGSLOPE	676
7.31.19 REC.TRIGTYPE	677
7.31.20 REC.TRIGVAL	678
7.32 REGEN Parameters	679
7.32.1 REGEN.POWER	680
7.32.2 REGEN.REXT	681
7.32.3 REGEN.TEXT	682
7.32.4 REGEN.TYPE	684
7.32.5 REGEN.WATTEXT	685
7.33 SD Commands	686
7.33.1 SD.LOAD	687
7.33.2 SD.SAVE	688
7.33.3 SD.STATUS	689
7.34 SM Parameters	690
7.34.1 SM.I1	691
7.34.2 SM.I2	692
7.34.3 SM.MODE	693
7.34.4 SM.MOVE	696
7.34.5 SM.T1	697
7.34.6 SM.T2	698
7.34.7 SM.V1	699
7.34.8 SM.V2	701
7.35 STO Parameters	703
7.35.1 STO.STATE	704
7.36 SWLS Parameters	705
7.36.1 SWLS.EN	706
7.36.2 SWLS.LIMIT0	708
7.36.3 SWLS.LIMIT1	709
7.36.4 SWLS.STATE	710
7.37 UNIT Parameters	711
7.37.1 UNIT.ACCLINEAR	712
7.37.2 UNIT.ACCROTARY	713
7.37.3 UNIT.LABEL	714
7.37.4 UNIT.PIN	715
7.37.5 UNIT.PLINEAR	716

7.37.6 UNIT.POUT	717
7.37.7 UNIT.PROTARY	718
7.37.8 UNIT.VLINEAR	719
7.37.9 UNIT.VROTARY	720
7.38 VBUS Parameters	721
7.38.1 VBUS.HALFVOLT	722
7.38.2 VBUS.OVFTHRESH	724
7.38.3 VBUS.OVWTHRESH	725
7.38.4 VBUS.RMSLIMIT	726
7.38.5 VBUS.UVFTHRESH	727
7.38.6 VBUS.UVMODE	728
7.38.7 VBUS.UVWTHRESH	729
7.38.8 VBUS.VALUE	730
7.39 VL Parameters	731
7.39.1 VL.ARPF1 TO VL.ARPF4	732
7.39.2 VL.ARPQ1 TO VL.ARPQ4	734
7.39.3 VL.ARTYPE1 TO VL.ARTYPE4	736
7.39.4 VL.ARZF1 TO VL.ARZF4	738
7.39.5 VL.ARZQ1 TO VL.ARZQ4	740
7.39.6 VL.BUSFF	742
7.39.7 VL.CMD	743
7.39.8 VL.CMDU	744
7.39.9 VL.ERR	746
7.39.10 VL.FB	747
7.39.11 VL.FBFILTER	748
7.39.12 VL.FBSOURCE	749
7.39.13 VL.FBUNFILTERED	750
7.39.14 VL.FF	751
7.39.15 VL.GENMODE	752
7.39.16 VL.KBUSFF	753
7.39.17 VL.KI	754
7.39.18 VL.KO	756
7.39.19 VL.KP	757
7.39.20 VL.KVFF	759
7.39.21 VL.LIMITN	760
7.39.22 VL.LIMITP	762
7.39.23 VL.LMJR	764
7.39.24 VL.MODEL	765
7.39.25 VL.OBSBW	766
7.39.26 VL.OBSMODE	767
7.39.27 VL.THRESH	768
7.39.28 VL.VFTHRESH	770
7.40 VM Parameters	771
7.40.1 VM.AUTOSTART	772
7.40.2 VM.ERR	773

7.40.3 VM.INTRTIMER	775
7.40.4 VM.PGMCOMPILERVERSION	776
7.40.5 VM.PGMERRORLIST	777
7.40.6 VM.RESTART	778
7.40.7 VM.START	779
7.40.8 VM.STATE	780
7.40.9 VM.STOP	781
7.41 WHEN Parameters	782
7.41.1 When	783
7.41.2 WHEN.DRVHANDWHEEL	786
7.41.3 WHEN.DRVTIME	787
7.41.4 WHEN.FB1MECHPOS	788
7.41.5 WHEN.FB3P	789
7.41.6 WHEN.PLCMD	790
7.41.7 WHEN.PLFB	791
7.42 WS Parameters	792
7.42.1 WS.ARM	793
7.42.2 WS.CHECKMODE	794
7.42.3 WS.CHECKT	796
7.42.4 WS.CHECKV	797
7.42.5 WS.DISARM	798
7.42.6 WS.DISTMAX	799
7.42.7 WS.DISTMIN	800
7.42.8 WS.FREQ	801
7.42.9 WS.IMAX	802
7.42.10 WS.MODE	803
7.42.11 WS.NUMLOOPS	804
7.42.12 WS.STATE	805
7.42.13 WS.T	806
7.42.14 WS.TDELAY1	807
7.42.15 WS.TDELAY2	808
7.42.16 WS.TDELAY3	809
7.42.17 WS.TIRAMP	810
7.42.18 WS.TSTANDSTILL	811
7.42.19 WS.VTHRESH	812
8 Appendix A: BASIC Sample Programs	814

1 About this User Guide

This guide describes the operation and use of the AKD drive. Each section details a specific topic related to the use of the product in simple terms which will help you get the most from the product. Each section includes examples to help guide you in setting up and using the various features available in the drive.

This guide is for users who have installed and tested the drive according to the *AKD Installation Manual*. The *AKD Installation Manual* is included on the product disk and contains critical safety information.

2 Program View

The program view in AKD WorkBench is specific to AKD BASIC drives and can only be accessed using an AKD BASIC drive type in either online or offline mode. Programs can be compiled in offline mode, but an AKD BASIC drive must be connected to download and run a program.

2.1 Toolbar Options

The toolbar at the top of the program view contains a number of tools to assist you in programming.

2.1.1 New ...

The Program view loads as an empty window. Create a new program by clicking the new icon in the upper-left corner and selecting either **BASIC** or **BASIC Using Current Drive Params**. The **BASIC** selection will load an empty template. The **BASIC Using Current Drive Params** selection will populate the template with all current drive values. Then select the location and name of your new project file, and click save.

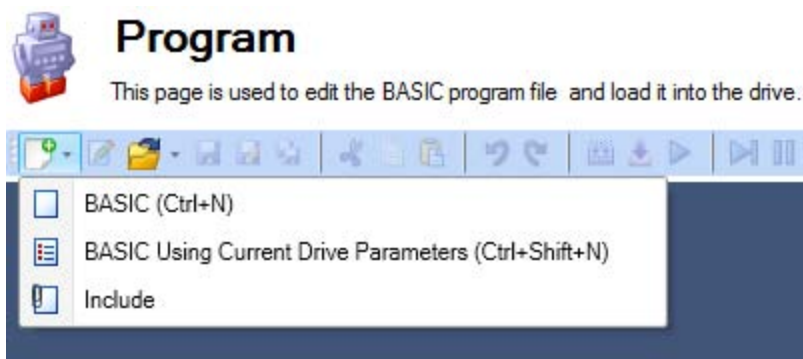

This will load the BASIC template from which you can begin programming.

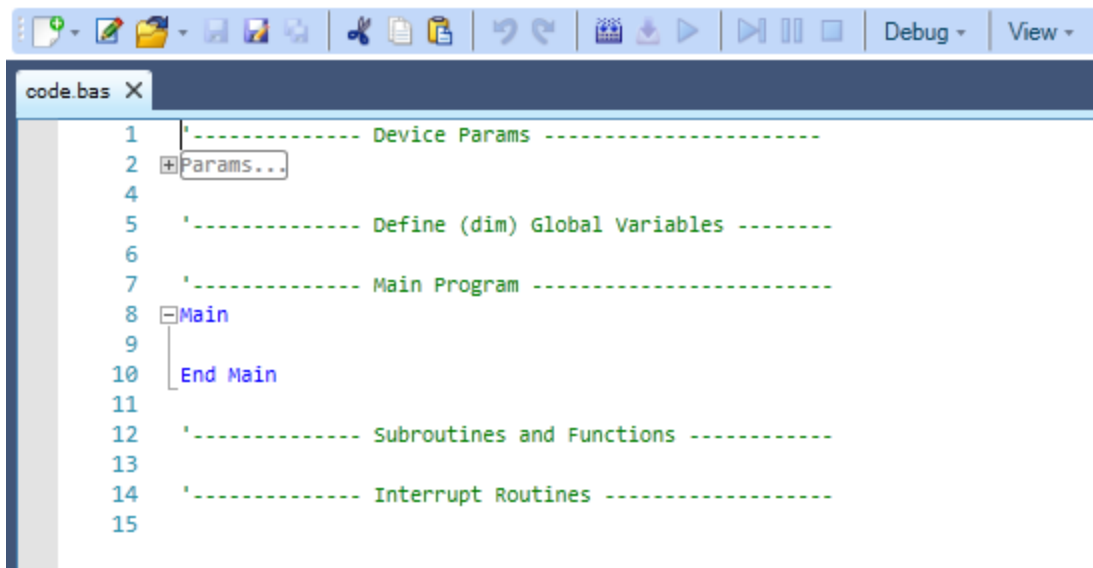

2.1.2 Save / Save As

Once you have written a program, save it using the "Save" or "Save As" function on the toolbar .

2.1.3 Open

To open a previous project file click the "Open" function  and locate your file in the explorer.

2.1.4 Edit Parameters Section

Clicking on the Edit Params Section tool  will prompt you to populate the Params section of your code with all the current drive settings. Clicking yes will overwrite all current param definitions with the current drive values.

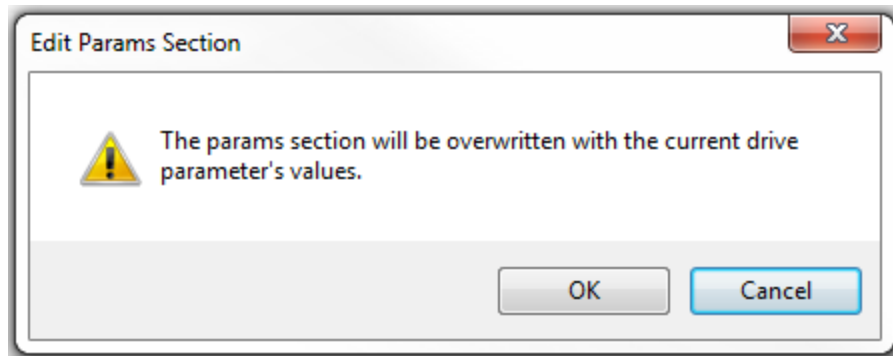

2.1.5 Compile / Download / Run

The Compile button will compile your source code to binary so that you may download the program to the drive.

The Download button will download your compiled code and source code to the drive by default. If you do not wish to download the source code to the drive, go to the options menu, choose download and de-select download source with binary.

The run button will issue a VM.START to start the BASIC program in the drive. If the active BASIC program in the editor is different than the program in the drive, the run button will compile and download the program before running.

2.1.6 Continue / Pause / Stop

The Continue, Pause, and Stop options  allow you to control your program while it is running.

2.1.7 Debug

The Debugger allows you to set break points and step through your program.

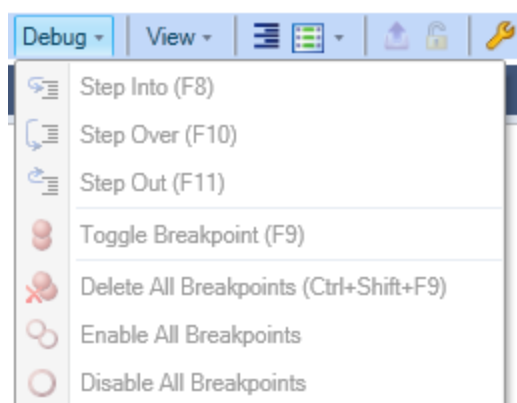

2.1.8 View

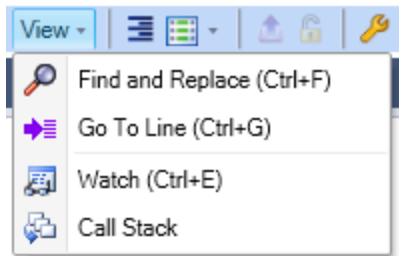

Use Find and Replace to find keywords in your program and replace them with a new keyword

Use the Go To Line to go to a specific line of code

Watch will open the expression evaluator tab. The expression evaluator is only valid while using the debugger. You can evaluate any drive parameter or user defined variable when the program is paused by the debugger.

Call Stack will open the call stack tab

2.1.9 Format Document

The format document tool  implements correct line indentation across all code.

2.1.10 Insert Code Snippet

The Insert Code Snippet tool  presents a list of existing code snippets, which can be selected and inserted into the program at the point where the cursor is currently placed.

2.1.11 Upload?

The upload tool uploads the source code from the drive. If the source code has not been downloaded, this option is not available. The tools menu allows you to select if the source code is to be downloaded with the binary.

2.1.12 Lock

The lock tool password protects the source code in the drive. If a new program is downloaded to a drive, the original source code and password protection is erased.

2.2 Incompatible Firmware

If your BASIC firmware is incompatible, an incompatibility error will display in the program view.



Program View

Program View is disabled

The connected drive contains an old firmware (1.8.0.4) which is incompatible with this version of WorkBench.

To use Program View

- a. Upgrade your drive's firmware to the latest version (minimum 1.9.0.0).
- b. Use an older WorkBench version (1.8.0) with this drive.

We recommend to upgrade the firmware...

[Get latest firmware](#)

[Get older WorkBench for BASIC](#)

[? More information](#)

This error is due to major WorkBench and compiler changes since your last firmware update, causing your current firmware to be incompatible with your current WorkBench version. These changes improved the product's ability to handle revision control of the language. However, the improvement also required changes in how WorkBench and firmware communicate, which caused the incompatibility. The improvement will allow the editor to recognize the firmware version being used and auto-recognize the parameters and commands inherent to that firmware. This allows better use of mis-matching WorkBench and firmware versions in the future.

See VM.PGMCOMPILERVERSION (pg 776) and VM.PGMERRORLIST (pg 777) for more information on using this new feature.

2.2.1 Resolving Incompatible Firmware

If your firmware is incompatible, we recommend upgrading the AKD BASIC's firmware to version 1.9 or later in order to take advantage of the new feature and allow seamless integration moving forward.

If the product using AKD BASIC is deep in its product lifecycle, or there are version controls in place that prevent changes to the machine device firmware, upgrading the firmware may not be suitable. In this case, downgrading to an older version of WorkBench (version 1.8.0.32358 or earlier) is recommended.

NOTE

It is not necessary to uninstall your current WorkBench version in order to install an older version. Multiple versions of WorkBench can be installed simultaneously on one PC.

To upgrade to the latest firmware version, please visit the AKD BASIC [software/firmware tab](#) on kollmorgen.com.





To downgrade to an older version of WorkBench, please visit the [AKD BASIC archive tab](#) on kollmorgen.com.





See Also

Unsupported Firmware (pg 1) | Invalid Firmware (pg 1)

2.3 Unsupported Parameters

If a parameter is being used in a BASIC program which is not supported by the current firmware version, an error will be displayed in the error list after the program is downloaded to the drive.

Error List				
Description	Line	Column	File/Program	
 The drive command [AIN.ZERO] is not supported by the FW.			code	
 The drive parameter [TEMP.POWER1] (integer) is not supported by the FW.			code	
 The drive parameter [FB1.POFFSET] (long) is not supported by the FW.			code	
 The drive parameter [FB2.POFFSET] (long) is not supported by the FW.			code	
 The drive parameter [IL.KACFF] (float) is not supported by the FW.			code	

 Error List
  Console
  Output
  Watch
  Call Stack

Error: [0102] BASIC program invalid. Ln 1 Ch 1 code

This list of unsupported parameters from a BASIC program can also be read from VM.PGMERRORLIST (pg 777).

When the drive returns Fault 831 (BASIC program is invalid), you can either:

1. Use VM.PGMERRORLIST to identify and remove unsupported calls to items.
- or
2. Upgrade your firmware, and then re-compile, and re-download the BASIC program.

3 AKD BASIC Language

This chapter describes the overall structure of an AKD BASIC program and the elements of the AKD BASIC language. Topics covered are:

- scope
- program structure
 - setup parameters
 - global variables, constants and aliases
 - 'main' program, subroutines, functions and interrupt handlers
- language description
 - lexical conventions
 - identifiers
 - data types
 - constants
 - statements
 - built-in functions
 - parameters
 - expressions
 - function invocation
 - \$include
 - arrays and parameter lists
 - optimizations

For a list of AKD BASIC sample programs, see Appendix A: BASIC Sample Programs (pg 814).

3.1 AKD BASIC Program Structure

3.1.1 Local Variables

The notion of 'scope' is a key concept in AKD BASIC programs. By 'scope', we mean those parts of the program in which a particular name is 'visible'. There are two levels of scope in AKD BASIC — global and local. Variables (and constant definitions, aliases, etc.) defined inside a 'main' definition, or a subroutine, function, or interrupt handler definition, are considered to be 'local' in scope (visible only within that function).

3.1.2 Global Variables

All other definitions (those occurring outside functions) are considered 'global' in scope (visible inside main, and inside any subroutine, function, or interrupt handler). For example, consider the following simple AKD BASIC program:

```
'----- Define (dim) Global Variables -----
dim i as integer
'----- Main Program -----
Main
  dim i as integer
  for i = 1 to 10
```

```

        print "the cube of "; i; "is "; cube(i)
        call increment
    next i
End Main
'----- Subroutines and Functions -----
function cube(i as integer) as integer
    cube = i * i * i
end function
sub increment
    i = i + 1
end sub

```

This program prints a table of the cubes of the integers from 1 to 10. The first (global) definition of 'i' is visible inside subroutine 'increment', but 'shadowed' by the 'i' in main and function 'cube'. The definition of 'i' inside 'main' is local to 'main', and is NOT the same variable as the 'i' inside the function 'cube', or inside the subroutine 'increment'. These same scope rules apply to constant definitions and aliases, as well.

3.2 Program Memory Space

A total of 64k is available for code and data space. Compile a program and click the Output tab to see the amount of code space and data space currently in use by that program.

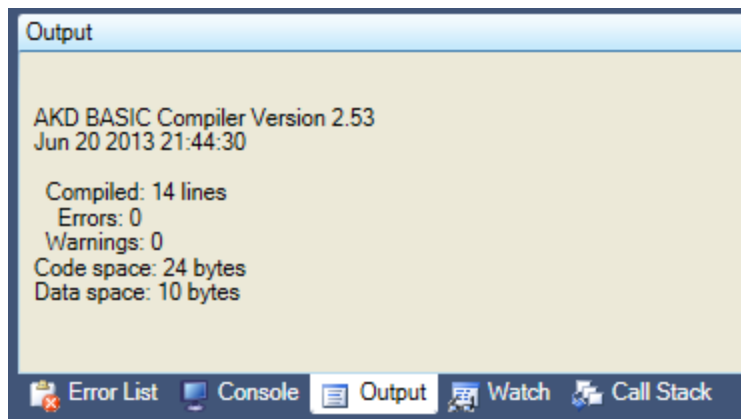

3.3 Program Sections

The major sections of an AKD BASIC program are:

- setup parameter definitions
- global variables, constants, and aliases
- 'main' program, subroutines, functions, and interrupt handlers

Although these sections may appear in any order, we recommend that you keep them in the order shown, or at least, choose a single layout style and use it consistently.

3.3.1 Program Template

The program below is an example of the template generated automatically by WorkBench:

```

'----- Device Params -----
Params

```

```

End Params
'----- Define (dim) Global Variables -----
'----- Main Program -----
Main
End Main
'----- Subroutines and Functions -----
'----- Interrupt Routines -----

```

These sections are described in greater detail in the following paragraphs.

3.3.2 Setup Parameter Definitions

This section of the program defines the setup parameters for drive tuning and configuration. It is executed immediately upon power-up (if VM.AUTOSTART = 1), before entering main, and before any interrupts are enabled. The section begins with `Param` and ends with `End Param` (this is similar to the format used to define a subroutine or function). The only statements permitted in this section are assignment statements of the form:

```
<parameter> = <constant expression>
```

This section can be automatically generated by WorkBench when a New Program is created. Choose "current drive parameters" to include the connected drive's setup parameters in your program. If you choose to not include the setup parameters in your program, be sure to save the setup parameters to the drive to ensure proper drive setup upon power up.

3.3.3 Global Variables, Constants, and Aliases

This section contains variables, constant definitions, and global alias expressions — they apply everywhere in the program, unless specifically overridden by another declaration at local scope (inside a subroutine, function, or interrupt handler). Global definitions may be placed almost anywhere in the program text — between subroutines, before or after 'main', and so on.

Global variables, constants, and aliases do not need to be defined before use — the only requirement is that they be defined at some point in the program text. You may have multiple instances of the global variables section throughout your program. However, as a matter of good programming style, we recommend that you keep all global definitions in one place, preferably at or near the beginning of your program.

3.3.4 Variable Definitions

The format of a global variable definition is:

```

dim a,b as integer, x,y,z as float
dim ia(3,4) as integer
dim s1, s2 as string*80
dim sa(5,2) as string
dim j, k, l as integer NV

```

Line 1 declares a and b as integers, x,y, and z as floats. Line 2 declares a 3 x 4 array of integers. Line 3 declares s1 and s2 as strings, each of length 80. Line 4 declares sa as a 5 x 2 array of strings, each with the default length of 32 characters. Line 5 defines 3 integers, j, k, and l as NV.

In addition, global variables can be specified as 'NV' to indicate their values are retained when power is turned off. All other global variables are automatically initialized when the program begins (strings are set to empty, and floats and integers are set to 0). There are no restrictions on the ordering of volatile vs. non-volatile user-variables. For ease of program maintenance, place all non-volatile variables definitions in a single section at the beginning of the program, and add new variables to the end of that section.

3.3.5 Constant Definitions

The format of a constant declaration is:

```
const <name> = <constant_expression>
```

as in

```
const ARRAY_SIZE = 4 * NUMBER_OF_ENTRIES
const PI_SQUARE = 3.1415926535 ^ 2
const GREETING = "Hello"
const GREETING = "Hello"
const NUMBER_OF_ENTRIES = 5
```

Names for constants follow the same rules as variable names. ‘Forward definitions’ are allowed. Circular definitions are detected and reported at compile-time. Although it is not required, it is convenient to adopt a convention of keeping all constants in UPPER_CASE, so you can easily distinguish between constants and variables in the program.

Constant definitions are entirely ‘folded’ at compile-time. Feel free to write maintainable constant expressions such as:

```
const LENGTH = 3
const WIDTH = 10
const AREA = LENGTH * WIDTH
```

The value of AREA is computed at compile-time, so the program does NOT need to compute this at run-time and the program is easier to maintain if LENGTH changes at some future date.

3.3.6 Alias Definitions

Aliases allow you to define your own names for system resources, such as input / output pins. The intention is to make it possible for you to use names that are meaningful to you in your particular application.

The format of an alias expression is:

```
alias <name> = <expression>
```

For example, the following alias defines application-specific uses of input # 1:

```
alias CONVEYOR_IS_RUNNING = (DIN1.STATE = 0)
alias CONVEYOR_IS_STOPPED = (DIN1.STATE = 1)
if CONVEYOR_IS_RUNNING then
  print"running"
else
  print"stopped"
```

An alias is much more powerful than a constant. Constant expressions are computable at compile-time, while an alias has a value that is only known (in general) at the time it is used. Use aliases with care — too much aliasing can make it very difficult for you to understand the program.

3.4 Main Program, Subroutines, Functions & Interrupt Handlers

These sections share the same fundamental structure:

<section>

<declarations>

<statements>

<section end>

An example of each of these sections follows, with an explanation of key points.

3.4.1 Main Definitions

For main, a typical definition is:

```

Main
    dim i as integer
    i = 1
    print i
End Main

```

The variable 'i' defined above in the 'dim' statement is a local variable — it is not accessible to other functions, and inside 'main', its definition overrides any other variable named 'i' that might exist at global scope.

Unlike global variables, local variables **MUST** be defined at the beginning of the section — they must appear before any executable statement in main. For example, the following is illegal:

```

Main
    dim i as integer
    i = 1
    dim j as integer    `this is an error!
    j = i
End Main

```

You may also define local constant definitions and aliases, provided that like local variables, they appear before any executable statement. Local constant definitions override global definitions of the same name. For example, given the following global definitions,

```

const N = 1
Main
    const N = "Hello, world!"
    print N
    call sub1
End Main
'----- Subroutines and Functions -----
sub sub1
    print N
end sub

```

The program prints to the console:

```

Hello world!
1

```

Because the N visible inside main is the constant defined there, while the N visible to sub1 is the global constant N, whose value is 1.

The main program is the section of your program that is executed immediately after the 'params section, regardless of its position in the program text. Other functions, subroutines, and interrupt handlers are executed according to the flow of control defined in the program.

main does not accept arguments, and cannot be called from any other subroutine, function, or interrupt handler.

3.4.2 Subroutine Definition

For a subroutine such as `print_sum`, a typical definition is:

```
sub print_sum(i,j as integer)
    print i+j
end sub
```

The arguments to this subroutine are specified as integer variables, and are passed by value - any assignments to these variables has no effect on the arguments supplied by the caller. Subroutines are invoked by 'call' instructions, as in `call print_sum(3,4)`.

3.4.3 Function Definition

For a function such as `sum_squares`, a typical definition is:

```
function sum_squares(i,j as integer) as integer
    sum_squares = i^2 + j^2
end function
```

The function above returns a value of type integer. The value of the function is assigned by assigning to the name of the function, as if it were a variable.

NOTE

It is not legal to use the function name as a variable name on the left-hand-side of an assignment - a function name on the left-hand-side is always an INVOCATION of that function.

There must be at least one statement in the function that assigns a value to the function. It is not possible to detect at compile-time if the statement will actually execute. Functions are invoked by name, as in `print sum_squares(3,4)`. This is syntactically identical to an array reference.

3.4.4 Interrupt Handler Definition

The Interrupt statement marks the beginning of an Interrupt Service Routine. The Interrupt Service Routine is defined by a program structure resembling a subroutine. The interrupt feature permits execution of a user-defined subroutine upon receipt of a hardware interrupt signal or a pre-defined interrupt event.

Interrupts are triggered by pre-defined events or external hardware sources. The interrupt-source-name and interrupt enable flag are unique for each interrupt source. For a list of interrupt sources see Interrupt {Source} (pg 533).

Receiving an interrupt will suspend program execution and the interrupt service routine will be executed. Then program execution will resume at the point that it was interrupted.

Interrupts are enabled (or disabled) by setting (or clearing) the associated interrupt enable flag. Interrupts are disabled until explicitly enabled. After an interrupt is triggered it is automatically disabled until it is enabled again in your program.

```
Main
    DRV.TIME = 0
    INTR.DIN1LO = 1 'enables interrupt
    while 1
        pause(0.5)
```

```

        DOUT1.STATEU=0 : Pause (0.005) : DOUT1.STATEU=1
    wend
end main
'the following interrupt defines what occurs for interrupt DIN1LO
Interrupt DIN1LO
    print "I'm awake"
    If DRV.TIME > 10 then
        print "OK. That's it."
    else
        INTR.DIN1LO = 1 're-enables interrupt
    end if
End Interrupt

```

The interrupt is re-enabled by the statement `INTR.DIN1LO = 1`. A similar statement must be executed once before the interrupt is serviced. It is a run-time error to attempt to enable an interrupt for which no handler is defined.

Interrupt handlers do not return values and cannot have arguments. They declare local variables, constants, and aliases. Interrupt handlers are invoked when the AKD hardware detects that the designated interrupt condition is satisfied (provided that the interrupt is enabled).

Interrupts are triggered by pre-defined events or external hardware sources. The interrupt-source-name and interrupt enable flag are unique for each interrupt source.

Receiving an interrupt will suspend program execution and the interrupt service routine will be executed. Then program execution will resume at the point that it was interrupted.

Interrupts are enabled (or disabled) by setting (or clearing) the associated interrupt enable flag. Interrupts are disabled until explicitly enabled. After an interrupt is triggered it is automatically disabled until it is enabled again in your program.

3.5 Language Definition

3.5.1 Lexical Conventions

AKD BASIC is case-insensitive. String literals are not modified, but all other text is treated as if it were entered in upper case. This means that the identifiers `spin`, `Spin`, and `SPIN` all refer to the same entity.

3.5.2 Identifiers

Identifiers are alphanumeric and must start with an alphabetic character or underscore. In addition, they may include the underscore character ('_') and dollar sign ('\$'). Identifiers denote variables, functions, sub-routines, and statement labels, symbolic constants, and aliases. Identifiers are a maximum of 40 characters. User-defined identifiers may not include the period ('.'). Use of a longer identifier is a compile-time error.

Although both forms are accepted for compatibility, the latter form is preferred. Although AKD BASIC is case-insensitive, we recommend that you adopt a consistent naming convention, such as `Move.Acc`, and avoid having `Move.acc`, `move.acc`, and `move.Acc` in the same program.

3.5.3 Data Types

The pre-defined types are `INTEGER`, `FLOAT`, `LONG` and `STRING`. `LONG` is a 64-bit signed integer. `INTEGER` variables are 32-bit signed integers. `FLOAT` variables are IEEE single-precision floating point numbers. `STRING` variables are represented internally as a maximum length, a current length, and an array of ASCII characters (can contain null characters).

When a FLOAT result is assigned to an INTEGER variable, or when a FLOAT argument is used where an INTEGER is expected, the value is coerced to an integer before use. Coercion from FLOAT to INTEGER always rounds to the nearest integer. For example:

1.2 rounds to 1
 1.7 rounds to 2
 -1.2 rounds to -1
 -1.7 rounds to -2

Scalar INTEGER and FLOAT coercion is automatically provided for function arguments. When passing ARRAYS as arguments, the types must match exactly because coercion is prohibitively expensive at run-time.

String assignment is checked at run-time. An attempt to copy a string to a destination too small results in a run-time error. String indexing is 1-origin. For example, `mid$("abc", 1, 1)` returns the string, `a`.

STRING variables have a firmware-imposed maximum length of 230 characters and a default maximum length of 32 characters. They may be assigned a different maximum length by declaring them to be of type `STRING*n` where `n` is a positive integer between 1 and 230 (inclusive).

Declare arrays of the pre-defined types. Arrays have a maximum rank of four dimensions. The upper-bound of each dimension has no compiler-defined limit. However, because of the limited data space of the controller, there is a logical upper-bound that depends on the controller model.

Array indexing is 1-origin. The indices in each dimension range from 1 to the upper-bound of the dimension. Every reference to an array element is checked at run-time. Any attempt to reference beyond the bounds of the array causes a run-time error. New types cannot be defined.

3.5.4 Literal Constants

String constants begin and end with the double-quotes (`""`). They cannot extend past the end of the input line. Any printable ASCII character appears in a string constant. An attempt to generate a string literal with non-ASCII characters causes a compile-time error. No check is made to verify that non-ASCII strings are not created at run-time, so avoid doing so.

3.5.5 Decimal Integer Constants

Decimal integer constants are a string of decimal digits with no decimal point. A leading `'-'` sign is optional and is parsed as a unary minus. For example:

1
 -1
 314159

are all valid decimal constants.

3.5.6 Hexadecimal Constants

Hexadecimal constants are denoted by a leading `&H` or `&h`, and cannot have a sign or decimal point. Hexadecimal constants are composed from the set `[0-9A-Fa-f]`. Upper- and lower-case may be mixed.

For example:

`&h00ff`
`&HFF00`
`&H1234abcd`

are all valid hexadecimal constants. Octal and binary constants are not supported.

3.5.7 Floating-Point Constants

Floating-point constants are specified in fixed-point or mantissa-exponent notation. A floating-point constant consists of one of the following.

digit	[0-9]
optsign	'+' '-' /* nothing */
fixed	optsign {digit}+ '.' {digit}*optsign '.' {digit}+
exp	fixed 'e' optsign {digit}+
float	fixed exp

For example:

```
0.1
.1
-.1
-0.1
3.14159E-6
-1.0E6
```

are all valid floating point constants. By design, "." is not a legal floating-point constant.

3.6 Statements

Statements are separated by a new line (CR-LF) or a colon (':'). The statements of the language are:

3.6.1 Alias

Create an alias for an identifier (not just any identifier). Alias is either a parameter or another alias. ID must be a legal variable name. You cannot create an alias for an array element.

Like Const definitions, Alias definitions can be made to identifiers not yet defined. Circular definitions are not allowed.

Any duplicate definition of an identifier in the same scope is illegal. However, a local definition can shadow a definition from the global scope. Using a single identifier to denote two different objects is NOT allowed (i.e., you cannot have both a label and a variable named `all_done`).

Like constant, variable, and function declarations, Alias declarations made in the global scope are imported into all functions (including the main function).

Example:

```
Alias speed = MOTOR.SPEED 'save some keystrokes
```

3.6.2 Call

```
Call sub[(arg1, arg2, ...)]
```

`sub` is the name of a subroutine. The current program counter is saved and `sub` is invoked. When `sub` finishes (by reaching either an `exit sub` or `end sub` statement, control is returned to the statement logically following `Call`.

A subroutine is essentially a function with no return value. The parameter passing conventions followed by subroutines are the same as those followed by functions.

3.6.3 CIs

This statement transmits 40 line-feed characters (ASCII code = 10) to the serial port. `CIs` clears the display of the console.

3.6.4 Const

```
const name = x
```

Declares symbolic constants to be used instead of numeric values. Forward references are allowed, but circular references are not supported.

```
'supported
const x = y + 2
const y = 17
'unsupported
const x = y + 2
const y = x - 2
```

Like alias, variable, and function declarations, Const declarations made in the global scope are imported into all functions (including the main function).

3.6.5 Dim

```
Dim var1 [, var2 [...]] as type [NV]
```

All variables must be declared. Local variables must be declared in the function before use.

The NV specifier is used on a Dim statement in the global scope.

Variables in the global scope are automatically imported into functions and subroutines. Variables in function scope (including inside the main function) are not accessible in other functions.

Arrays cannot be assigned directly.

```
'This is not allowed
dim x(5), y(5) as integer
x = y
'Instead, a loop is needed:
dim x(5), y(5), i as integer
for i = 1 to 5
    x(i) = y(i)
next i
```

3.6.6 Exit

Exit {{Sub|Function|Interrupt|For|While}}

Exits the closest enclosing context of the specified type. It is a compile-time error to EXIT a construct not currently in scope.

3.6.7 For...Next

For loop_counter = Start_Value To End_Value [Step increment]

...statements...

Next

If step increment is not specified, uses 1 as the step increment. If step increment is positive, continues to the value of End_Value. If step increment is negative, continues to the value of var = limit.

The loop index variable must be a simple identifier, not an array element or a parameter and must be a numeric variable (integer or float).

```

for var = init to limit step delta
  stlist
next var

```

Substantially more efficient code is generated if delta is a constant (i.e., the default value of 1 is used, or specified as an expression that is evaluated at compile-time).

3.6.8 Function

Function function-name [(argument-list)] as function-type

...statements...

End Function

On function entry, all local variable strings are "" and all numeric locals are zero (including all elements of local arrays). If the function takes no arguments, omit the argument-list. An empty argument-list is illegal. The value returned from the function is specified by assigning an identifier with the name of the function.

Example:

```

function cube (x as float) as float
  cube = x * x * x
end function

```

Arguments are passed by value. Arrays can not be returned by a function. Arrays passed to a function are passed by value.

If the return value is not set, a runtime error condition is generated (caught with ON ERROR).

Array actuals must conform with formals to the extent that they have the same number of dimensions, and EXACTLY the same type. The size of each dimension is available to the function through the use of local constants that are bound on function entry.

Example:

```

function sum(x(n) as integer) as integer
  dim i, total as integer
  sum = 0
  for i = 1 to n
    total = total + x(i)
  next
  sum = total
end function

```

This function exploits the fact that the variable N is automatically assigned a value when the function is called and the value is the extent of the array passed on invocation. N is a read-only variable in this context. Attempts to write to N cause compile-time errors.

The local variable, total is automatically initialized to 0 upon function entry.

3.6.9 GoTo

GoTo label

A program can only GoTo a label in the same scope. A GoTo may jump out of a For or While loop, but not INTO one.

3.6.10 If...Then...Else

```

if condition1 then
    ...statement block1...
elseif condition2 then
    ...statement block2...
else
    ...statement block3...
end if

```

IF...THEN...ELSE statements control program execution based on the evaluation of numeric expressions. The IF...THEN...ELSE decision structure permits the execution of program statements or allows branching to other parts of the program based on the evaluation of the expression.

There are two structures of IF... THEN...ELSE statements, single line and block formats.

3.6.11 \$Include

```

$include inclfile
$include include-file-name

```

Textually include inclfile at this point in the compilation. There can be no space between \$ and include. The \$include directive must start at the beginning of the line.

3.6.12 Input

```

input [prompt-string][,|;]input-variable

```

Input (pg 130) reads a character string received by the console tab in the program view, terminated by a carriage return.

As an option, the prompt message is transmitted when the Input statement is encountered. If the prompt string is followed by a semicolon, a question mark is printed at the end of the prompt string. If a comma follows the prompt string, no question mark is printed. This input statement is typically used for debugging purposes.

3.6.13 Interrupt ... End Interrupt

```

interrupt {Interrupt-Source-Name}
    ...program statements...
end interrupt

```

Interrupt handlers can be located anywhere in the program text (e.g., before main).

3.6.14 MOVE.ABORT

MOVE.ABORT stops motor motion and allows continued program execution. Deceleration is determined by the controlled stop deceleration rate (CS.DEC).

3.6.15 MOVE.GOABS

MOVE.GOABS (Go Absolute) moves the motor to the position specified by MOVE.TARGETPOS. This position is based on a zero position at electrical home.

The motor speed follows a velocity profile as specified by MOVE.ACC, MOVE.RUNSPEED, and MOVE.DEC. Direction of travel depends on current position and target position only (MOVE.DIR has no effect). After the program initiates MOVE.GOABS, it immediately goes to the next instruction.

Change MOVE.ACC, MOVE.RUNSPEED, and MOVE.DEC during a move using MOVE.GOUPDATE.

3.6.16 MOVE.GOHOME

MOVE.GOHOME moves the motor shaft to the electrical home position (PL.FB = 0).

The motor speed follows a trapezoidal velocity profile as specified by MOVE.ACC, MOVE.RUNSPEED, and MOVE.DEC. After the program initiates MOVE.GOHOME, it immediately goes to the next instruction.

MOVE.GOHOME performs the same action as setting MOVE.TARGETPOS to zero and executing a MOVE.GOABS function. Change MOVE.ACC, MOVE.DEC and MOVE.RUNSPEED during a move using MOVE.GOUPDATE

3.6.17 MOVE.GOREL

MOVE.GOREL (Go Relative) moves the motor shaft a relative distance from the current position.

Distance, as specified in MOVE.RELATIVEDIST, is either positive or negative. The motor speed follows a trapezoidal velocity profile as specified by MOVE.ACC, MOVE.RUNSPEED, and MOVE.DEC.

The program does not wait for motion completion. After the program initiates this move it immediately goes to the next instruction.

Change MOVE.ACC, MOVE.RUNSPEED, and MOVE.DEC during a move using MOVE.GOUPDATE.

3.6.18 MOVE.GOUPDATE

MOVE.GOUPDATE (Update Move) updates a move in process with new variables. This allows you to change motion “on the fly” without having to stop and restart the motion function with new variables.

3.6.19 MOVE.GOVEL

MOVE.GOVEL (Go Velocity) moves the motor shaft at a constant speed.

The motor accelerates and reaches maximum speed as specified by MOVE.ACC and MOVE.RUNSPEED, with direction determined by MOVE.DIR. Stop motion by:

- Programming MOVE.ABORT for maximum deceleration allowed by current limits.
- Programming MOVE.RUNSPEED = 0 for deceleration at rate set by MOVE.DEC.

After the program initiates MOVE.GOVEL, it immediately goes to the next instruction.

Change variables during a move using MOVE.GOUPDATE.

3.6.20 On Error GoTo

```
On Error Goto Error-Handler-Name
```

or

```
On Error Goto 0
```

When a firmware runtime error condition occurs, Error-Handler-Name is called, the error handler is de-installed, and an internal flag (inerror-handler) is set. Any subsequent runtime error (including attempting to set the error handler, or return from the On Error handler) causes an immediate Stop.

On Error Goto 0 disables the current On Error handler. If an error occurs when no error handler is installed, Stop is invoked.

3.6.21 Pause()

Pause(Pause_Time) causes the program to pause the amount of time specified by the Pause_Time argument. The motion of the motor is not affected.

3.6.22 Print

```
print expression1 [ [,;] expression2 ] [;]
```

Print a list of expressions, separated by delimiters to the console. Any number of delimiters (including zero) can appear before or after the list of expressions. At least one delimiter must appear between each pair of expressions in the print list. The print statement is primarily used for debugging purposes.

Example:

```
print \ print a newline
print , \ advance a single tab stop
print a,b \ print a and b, tab between
print a,b, \ print a and b, tab between and at end
print ,,,x,,, \ tab tab tab x tab tab tab
```

3.6.23 VM.RESTART

VM.RESTART clears the run time error variables and causes program execution to start again from the beginning of the program. Any Interrupts, Subroutines, WHEN statements or loops in process are aborted. This statement is used to continue program execution after a Run Time Error Handler or to abort from WHEN statements without satisfying the condition.

VM.RESTART does not clear the data area or change any program or motion variables.

3.6.24 Select Case

```
Select Case test-expression
  Case expression-list1
    ...statement block1...
  Case expression-list2
    ...statement block1...
  Case expression-list3
    ...statement block1...
  Case Else
    ...else block...
End Select
```

test-expression must evaluate to an INTEGER or FLOAT value.

expression-list1 is a non-empty list of case-defn, separated by commas.

There can be only one Case Else and, if present, it must appear as the last case. It is selected only if all other tests fail.

case-defn can be any of the following:

```

expr
expr to expr (tests inclusive (closed range))
is relop expr (<, =, =, =, > )
is expr (equiv to "is = expr")

```

Select-case statements where the case-defn expressions are composed solely of integer constants are evaluated much quicker at run-time. (Cases involving variables must be transformed to logically equivalent if-then-else statements.)

3.6.25 Static

Static var1 [, var2[...]] as type

where type is:

INTEGER 32 bit integer

FLOAT IEEE single precision float

STRING default length is 32 characters

Static is used for declaring variables before use. All variables (except parameters) must be declared before they can be used. The Static statement is used in a Function, Sub or Interrupt to specify that the specified variable's value be remembered even when the Function or Sub is finished. The next time that the Function, Sub or Interrupt is executed, the value will be available.

Example:

```

Main
  while 1
    call MySub
    pause(1)
  wend
End Main
'----- Subroutines and Functions -----
sub MySub
  dim x as integer 'value is forgotten
  static y as integer 'value is remembered
  x= x + 1
  y = y + 1
  print x,y
end sub

```

3.6.26 Stop

Stops the execution of the program.

3.6.27 Sub...End Sub

```

Sub [argument-list]
  ...body of the sub-procedure...
End Sub

```

Declare a subroutine. Invoked via Call. Optionally takes arguments. As with Function, it is illegal to provide an empty parameter list ('()') if the subroutine takes no parameters.

3.6.28 Swap

```
Swap x, y
```

Swaps the values of the variables. The variable types must be the same. Does not work on arrays or strings.

3.6.29 When

```
When when-condition , when-action
```

When is used for very fast output response to certain input conditions. You specify the condition and action. Upon encountering When, program execution waits until the defined condition is satisfied. The program immediately executes the action and continues with the next line of the program.

The When statement provides latching of several variables when the When condition is satisfied. These variables are:

WHEN.DRVHANDWHEEL	WHEN.FB1MECHPOS
WHEN.PLCMD	WHEN.DRVTIME
WHEN.PLFB	

The software checks for the defined condition at the 4Khz rate. The when action is queued up and executed immediately. The when action will be executed within 25 microseconds of the when condition being met.

3.6.30 While...Wend

```
While condition
    ...statement block...
Wend
```

While...Wend tells the program to execute a series of statements as long as an expression after the While statement is true.

If the expression is true, the loop statements between While and Wend are executed. The expression is evaluated again and if the expression is still true, the loop statements are executed again. This continues until the expression is no longer true. If the expression is not true, the statement immediately following the Wend statement is executed.

3.7 Built-in Functions

A function that takes a numeric argument (either FLOAT or INTEGER) returns the same type. Coercion between INTEGER and FLOAT is not performed unless necessary. (notation - the arguments n and m refer to INTEGER types, as in the definition of the MID\$ function, whose signature is MID\$(string, integer, integer).

Name	Args	Return	Semantics
ABS() (pg 72)	numeric	numeric	absolute value
ATAN() (pg 74)	float	float	arc tangent (radians)
CINT() (pg 76)	numeric	int	truncate (round to nearest int)
COS() (pg 77)	float	float	cosine
EXP() (pg 78)	float	float	e ^ arg, arg 88.02969 (o/w overflow)

Name	Args	Return	Semantics
FIX() (pg 79)	numeric	int	truncate (round toward zero)
INT() (pg 83)	numeric	int	truncate (round towards -INFINITY)
LOG() (pg 87)	float	float	natural log
LOG10() (pg 88)	float	float	log base 10
SGN() (pg 94)	numeric	integer	sign of argument: -1, 0, 1
SIN() (pg 95)	float	float	sine (radians)
SQRT() (pg 97)	float	float	square root of arg
TAN() (pg 100)	float	float	tangent (radians)

String function		Description	
ASC() (pg 73)	string	int	ASCII code for 1st char
CHR\$(pg 75)	int	string	One-character string containing the character with the ASCII code of arg. If arg 255, returns CHR\$(arg % 256).
HEX\$(pg 80)	int	string	Printable hexadecimal rep of arg (without leading &H).
INKEY\$(pg 81)		string	One-character string, read from serial port. Returns "" if no char available.
INSTR() (pg 82)	[pos],str1,str2	int	Index of str2 in str1, or 0 if not found. Optional first arg specifies where to start search (defaults to position 1).
LCASE\$(pg 84)	str	str	Returns lower-case copy of arg.
LEFT\$(pg 85)	str,n	str	Returns n leftmost chars of str.
LEN() (pg 86)	str	int	Returns length of str in bytes.
LTRIM\$(pg 89)	str	str	Trim leading spaces.
MID\$(pg 90)	str,n[,m]	str	Returns substring starting at position n [for up to to m bytes].
OCT\$(pg 91)	n	str	Octal string representation of arg.
RIGHT\$(pg 92)	str,n	str	Rightmost n chars of str.
RTRIM\$(pg 93)	str	str	Trim trailing spaces.
SPACE\$(pg 96)	n	str	Returns a string of n spaces.
STR\$(pg 98)	n	str	Decimal string representation of str.
STRING\$(pg 99)	n,str	str	Return n copies of first char of str.
TRIM\$(pg 101)	str	str	Trim leading AND trailing spaces.

String function			Description
UCASE\$((pg 102)	str	str	Returns upper-case copy of arg.
VAL() (pg 103)	str	numeric	Returns numeric value of str.

3.7.1 Parameters and Commands

The AKD BASIC language is augmented by a set of parameters, input/output parameters, and pre-defined commands. The parameters set motor-specific control parameters, and the pre-defined commands control the motor.

For example, MOVE.ACC, MOVE.DEC, and MOVE.RUNSPEED are used to set the acceleration rate, deceleration rate, and commanded motor speed for the next commanded move:

```
MOVE.ACC = 1000.0
MOVE.DEC = 1000.0
MOVE.RUNSPEED = 500.0
MOVE.GOVEL
```

The program fragment above sets up the relevant motion parameters, and commands the motor to move at the specified velocity.

You cannot create variables (or function names, etc.) that shadow pre-defined ones. For a complete list of Parameters and commands, refer to the [Parameter Guide](#) section in this manual.

3.8 Expressions

3.8.1 Arithmetic Expressions

Arithmetic expressions (expressions involving INTEGER and FLOAT values) use the following operators.

3.8.2 Numeric Operators

Operators higher in the table have greater precedence than those below.

Operator	Assoc	Name
^	right	exponentiation
-	right	unary minus
*	left	multiply
/	left	divide
MOD	left	modulo
+	left	add
-	left	subtract

3.8.3 Logical Operators

Operator	Assoc	Explanation
=, <, >, ≥, ≤, <=, >=	left	mathematical operators
NOT (pg 111), BNOT (pg 107)	right	not, bitwise not
AND (pg 105), BAND (pg 106)	left	and, bitwise and
OR (pg 112), BOR (pg 108), XOR (pg 116), BXOR (pg 109)	left	or, bitwise or, xor, bitwise xor

Logical expressions (as, for example, in the condition of an 'if' statement) also use these operators. Strings are concatenated with the '+' operator. Logical expressions are formed from strings, using the comparison operators, NOT, AND, OR, and BXOR, with the meaning of an empty string being FALSE, and a non-empty string being TRUE.

Integer values are coerced to floating point values as needed. Floating-point values are rounded when coerced to integer values.

Logical operators are NOT short-circuiting (i.e., when executing the code).

if a(x) or b(y) or c(z) then ...

if a(x) is true, b(y) and c(z) are still invoked.

Bxxx boolean operators are provided to support bitwise operations on integer values. They operate quite differently from their logical equivalents. For example:

2 and 1 has the value -1 (TRUE, since each operand is 'true'), but 2 bitand 1 has the value 0 since no matching bits are 1).

Similarly, 3 or 4 has the value -1(TRUE since at least one operand is not FALSE), while 3 BOR 4 has the value 7 (the three lsb's are set).

Remember that relational and logical operators return numeric values 0 for FALSE and -1 for TRUE. Any value not equal to FALSE is considered to be logically equivalent to TRUE for purposes of the logical operators.

It is syntactically incorrect to code:

```
dim a, b, c, x as integer
x = a < b < c
```

3.8.4 String Operators

Operator	Assoc	Name
<, >, ≤, ≥, =, <>, <=, >=	nonassoc	string comparisons
+	left	string concatenation

There is no implicit coercion between strings and numeric types. String comparison is case-sensitive. Relative comparisons are made using ASCII lexical ordering. The empty string sorts before all other strings. String comparison operators are non-associative because they evaluate to a numeric value.

3.8.5 Example

It makes no sense to say a\$ = b\$ = c\$.

It is sensible to say x = a\$ = b\$

x is assigned the value TRUE if a\$ is the same as b\$, and FALSE otherwise.

3.9 Function Invocation

A function invocation is denoted as:

```
var = func(arg1, arg2, ..., argn)
```

The arguments are passed by value (i.e., modifications made to the formal parameters inside a function are not reflected in the actuals). Arrays are also passed by value to functions. Arrays cannot be returned by a function. A function of no arguments is invoked by using the function name alone. For example, if func_none takes no arguments, then func_none is correct and func_none() is invalid.

The return value of a function may not be ignored by the caller. If the return value of a function is regularly ignored, the function should be rewritten as a subroutine (a function with no return value).

3.9.1 \$INCLUDE

Use \$INCLUDE to textually include one file in another. The \$INCLUDE facility is a simple, powerful way to create a consistent family of applications. By including source files containing commonly used functions, subroutines, constant definitions, aliases, etc., you have control over the source for each application. When you change the source, you update each application simply by recompiling (see Optimizations).

A file cannot include itself, either directly or indirectly. Include file nesting is allowed, but limited to a pre-defined maximum depth (currently 16).

The path of an include file is relative to the directory of the included file, not the current working directory of the compiler. Suppose, for example, the source program is in directory C:\WORK, and includes the file .C\H\HEADER, and the file HEADER includes COMMON. The compiler looks for COMMON in C:\H, not in C:\WORK.

```
C:\WORK
  A.BAS
    $INCLUDE "..\H\HEADER"
C:\H
  HEADER
    $INCLUDE "COMMON"
```

Compilation errors occur when a file is included multiple times. For example, if B.BAS includes files MATH and INCL, and INCL also includes MATH, MATH is included twice, causing a compile-time error.

```
B.BAS
  $INCLUDE "MATH"
  $INCLUDE "INCL"
INCL
  $INCLUDE "MATH"
```

3.10 Arrays and Function Parameter Lists

When an array parameter (formal) of a function or subroutine is declared, the number of dimensions is specified, but the extent of (number of elements in) each dimension is not specified. This allows the programmer some freedom when invoking such a function. For example, a function may be defined to take a one-dimensional array and compute the sum of the elements in the array. A single function can be written to take a one-dimensional array of any size and correctly compute the sum. (Because AKD BASIC checks array bounds at run time on each access, there is no risk that a function will read or write outside the bounds of the array.)

When a formal parameter to a function is an array, instead of specifying the extent of each dimension, a list of variables is used to both implicitly specify the number of dimensions and to hold the extent of each dimension. These variables are read-only and cannot be modified within the function.

Adopt a convention for assigning names to placeholders. One such convention is to use the name of the array with a numerical suffix. For example,

```
function f(a(a1,a2,a3) as integer) as integer
```

where a1, a2, and a3 are the variables that get the extents of the array, a.

The function f above would be called as follows:

```
dim x_array(3,4,5) as integer
dim y_array(1,2,10) as integer
print f(x_array()) + f(y_array())
```

In both invocations of `f`, the function correctly determines the extent of each dimension of the passed array.

Remember that when passing an array to a function, the type of the array must match EXACTLY with the type expected by the function. Unlike scalar arguments (implicitly coerced from float to int or int to float), arrays are NOT coerced. An attempt to pass an integer array to a function that expects a float array results in a compile-time error.

3.10.1 Optimizations

As mentioned in an earlier section, constant definitions are completely 'folded' at the point of definition. This is efficient code. Constant expressions inside AKD BASIC statements are also folded under certain conditions. For example, in the statement:

```
const PI = 3.1415926535
Main
  Print PI^2
End Main
```

The value of `PI^2` is not computed at run-time. It is detected as a constant value and pre-computed by the compiler as a single literal constant to be printed.

Similarly, the literal constant `3*4*PI` in

$$x = 3 * 4 * PI * x$$

is folded at compile-time, leaving only one multiplication to be performed at run-time.

However, certain constant expressions are not folded. For example:

$$x = 3 * PI * x * 4$$

is computed at run-time, involving 3 multiplications because the analysis of constant expressions does not attempt to exploit algebraic commutativity laws. Since the basic arithmetic operators are 'left associative', you can ensure the best performance by grouping constant factors together towards the left (or using a new constant definition).

If a function is not referenced (transitively from MAIN, plus any interrupt handlers), the compiler does not generate code for it. So, you can freely `$include` libraries with unused code (e.g., a comprehensive library containing functions supporting several possible axis configurations). Although the compiler parses and type-checks all the included source, it does not generate code into the downloaded program.

If select-case cases are all constants, more efficient code is generated. If a case is a variable, the generated code is equivalent to a string of if-then-else statements for all cases.

If any of the cases is an open-ended range (e.g., `is 10`), or covers a large range (e.g., `1 to 1000`), a fast table-lookup is generated.

If all of the cases are constant, and can be grouped into locally dense subsets, the fastest possible code is generated — a binary search of dispatch tables, followed by an indirect jump through the table. If speed is a consideration, keep your cases constant and close together. (values form a reasonably dense set.)

The compiler performs limited dead-code elimination based on simple constant analysis. For example:

```
const DEBUGGING = FALSE
Main
  dim i, sum as integer
  for i = 1 to 10
    sum = sum + i
    if DEBUGGING then
      print "partial sum is ";sum
```

```

    next i
End Main

```

Since the value of DEBUGGING is FALSE, the compiler recognizes that the printing of the partial sum never happens and does not generate the print statement. This allows you to place debugging code in strategic locations in your programs and effectively disable it when shipping a production version (shrinks the size of the generated code).

This dead-code elimination also applies to functions whose only point of reference lies in eliminated code. The functions themselves become dead-code and no code is generated for their definitions.

The compiler does not eliminate the print statement from the following program:

```

dim DEBUGGING as integer
Main
    dim i, sum as integer
    DEBUGGING = FALSE
    for i = 1 to 10
        sum = sum + i
        if DEBUGGING
            print"partial sum is ";sum
        next i
End Main

```

In this case, the print statement never executes, but the code to implement is generated because the value of the integer DEBUGGING could be changed by the AKD's Integrated Development Environment Debugger at runtime, causing the print statement to be executed!

3.11 AKD BASICModBus TCP/IP

Modbus TCP/IP, or Modbus TCP, is a Modbus variant used for communications over TCP/IP networks, connecting over port 502. A max of 3 masters can be connected to one drive at any time. Modbus standard limits one master to 256 slaves. Modbus and Workbench (telnet) can be connected to the same drive at the same time. Because Modbus and Telnet are processed in the AKD's background task, 5~10mS delay between messages will prevent over running the back ground task stack limits.

3.11.1 ModBus Parameter Table

For a list of parameters and their Modbus addresses, visit the Modbus Parameter Table in the AKD User Guide.

for 64 bit to 32 bit mapping, visit Modbus 64-bit Parameters to 32-bit Mapping in the AKD User Guide.

3.11.2 ModBus Register and Data Types

All predefined AKD parameters are Modbus 32 bit or 64 bit (some with and some without sign).

Because most HMI products don't support 64 bit numbers, the AKD also has a series of matching 32 bit parameters. Ex: PL.FB is a signed 64 bit integer with address number 588. There is also PL.FB_32 as a signed 32 bit integer with address number 2072. PL.FB_32 is the lower two 16 bit registers of PL.FB.

Typical HMI tag addressing will need the additional "40000" be added to the Modbus address number. Ex: To create a tag in an HMI to read PL.FB_32, the address number 42072 should be used.

All AKD command parameter will require writing a "1" to trigger the command. Ex: DRV.EN is used to enable the drive. To trigger the command, send "1" as a 32 bit integer to address 254.

3.11.3 User Created Variables with Assigned Modbus Address Numbers

User variables can be assigned an Modbus address number. The range of available numbers is from 5000 to 5999. An example program:

```
Dim int2 as integer
Dim flt1 as float
Dim long1 as long
MBInfo
$MMap32(5001, int2)
$MMap64(5003, long1)
$MMapfloat(5007, flt1)
End

'----- Main Program -----
Main
  'setup some data to be read
  int2 = 262144
  flt1 = 1.234
  Long1 = 17179869184
End Main
```

Notice that address numbers have to be skipped for mapped variables larger than 16 bit. Ex: In the program above, 5001 was assigned for a 32 bit integer and then next number available would be 5003.

3.11.4 Drive Fault Table

The parameter MODBUS.FAULT1 to MODBUS.FAULT10 is used to read any drive fault condition. The fault parameters are loaded with the AKD fault code, starting with parameter MODBUS.FAULT1. DRV.CLRFAULT will reset the drive and clear out any data in MODBUS.FAULT1 to MODBUS.FAULT10.

HMI fault tables only need to monitor MODBUS.FAULT1, but report faults, if present, in 1 to 10.

3.11.5 Drive Parameter Scaling Over Modbus

The predefined AKD velocity, position, acceleration, and deceleration parameters use the Modbus scaling and do not use the “user units” configured in Workbench.

MODBUS.PSCALE

MODBUS.PIN

MODBUS.POUT

The default is 2^{20} counts/ rev, 2^{20} counts/sec, and 2^{20} counts/sec²

User defined variables, which have assigned Modbus address numbers, are not effected by this scaling.

3.11.6 Special Modbus AKD Parameters

MODBUS.DIO

Bit 0 to 6	DIN.STATES
Bit 16 and 17	DOUT.STATES

MODBUS.DRVSTAT

Bit 0	Drive Active
Bit 1	STO Status

Bit 2	Pos Hw Limit
Bit 3	Neg Hw Limit
Bit 4	Pos Sw Limit
Bit 5	Neg Sw Limit

MODBUS.DRV

Bit 0	Stop
Bit 1	Enable

MODBUS.MOTOR

Bit 0	Has Brake
Bit 1	Brake Release

MODBUS.HOME

Bit 0	Start Homing
Bit 1	Set (current position as home position)

MODBUS.MT

Bit 0	Clear (clears motion task MT.NUM)
Bit 1	Continue
Bit 2	Load (load motion task MT.NUM)
Bit 3	Set
Bit 4	Move (start move of MT.NUM)

MODBUS.SM

Bit 0	One Direction (sets SM.MODE to either 0 or 1)
Bit 1	Start Move: Edge triggered 0 → 1 : Start motion (execution of SM.MOVE) 1 → 0 : Stop motion (execution of DRV.STOP)

3.11.7 ModBus Dynamic Mapping

For information on Modbus Dynamic Mapping visit Modbus Dynamic Mapping in the AKD User Guide.

3.12 Cam Profiling

In the AKD, a cam is a cyclic, generally non-linear relationship between master encoder position and slave (motor) position. The relationship between slave and master counts is no longer a constant ratio, but changes as a function of master counts. As in electronic gearing, once a cam is active, the program no longer needs to do anything special to maintain it – the motion profile is repeated indefinitely until the cam is deactivated.

In camming terminology, a master is typically an external encoder. The encoder is wired into the AKD BASIC encoder input port on X9. It is also possible to use the AKD BASIC's virtual (internal) encoder.

3.12.1 Procedure

To use a cam profile on the AKD BASIC, you must:

1. Create the cam profile (CAM.CREATE).
2. Activate the cam profile (CAM.ACTIVATE).

3.12.2 Related Variables

CAM.MASTER: Specifies the source of the input to the cam table for cam profiling.

CAM.CORRECTDIR: Specifies the direction of the correction move that is done when a new cam table is activated (by setting **CAM.ACTIVATE = n**).

CAM.ADDPOINT: Adds the specified "point" (master position and corresponding slave position) to the cam table being created.

3.12.3 Cam Wizard

The Cam Wizard is designed to solve cut to length applications. The picture below shows a typical setup:

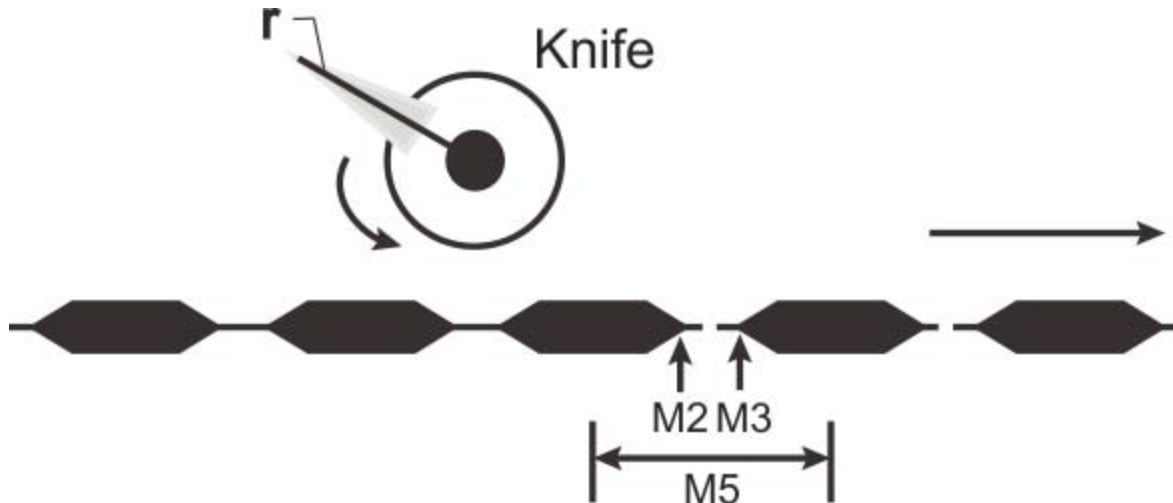

In this application, material is being fed beneath a rotary knife. The master encoder measures forward movement of the material under the knife. The slave motor controls rotation of the knife. In order for this to work properly, the slave motor must be controlled (as a function of master encoder counts) so the blade of the rotary knife:

1. Stays out of the way until the proper amount of material has passed
2. Accelerates so the speed of the knife matches the speed of the material during the cut
3. Decelerates back to the original speed until the material is almost in position for the next cut

NOTE

The rotary knife either accelerates or decelerates to match the speed of the material in the cut phase, depending on whether or not the circumference of the rotary knife is less than or greater than the length of the piece to be cut. You may need to interchange the terms 'accelerate' and 'decelerate', or simply think of them as signed quantities.

AKD BASIC's **CAM.ADDPOINT** statement specifies a cam profile as a mapping from master position to slave position. The problem refers to relative velocities and accelerations. It is not always clear how to get from velocity and acceleration to position.

The Cam Wizard was designed to make such applications easy to implement. You provide:

1. The master positions corresponding to the length of material to be cut
2. The slave positions corresponding to one complete rotation of the knife with respect to the master positions

Once you have provided these three pieces of information, the Cam Wizard automatically:

1. Generates a subroutine to create the cam table

2. Generates a subroutine to activate the cam

3.12.4 Example

You can create a cam to approximate any continuous function, but the Cam Wizard cannot help you with it. The basic technique is to develop an AKD BASIC expression (or function) defining the slave position as a function of master position and use it to generate a series of CAM.ADDPOINT statements at appropriate master position intervals, such as the one shown in the next figure.

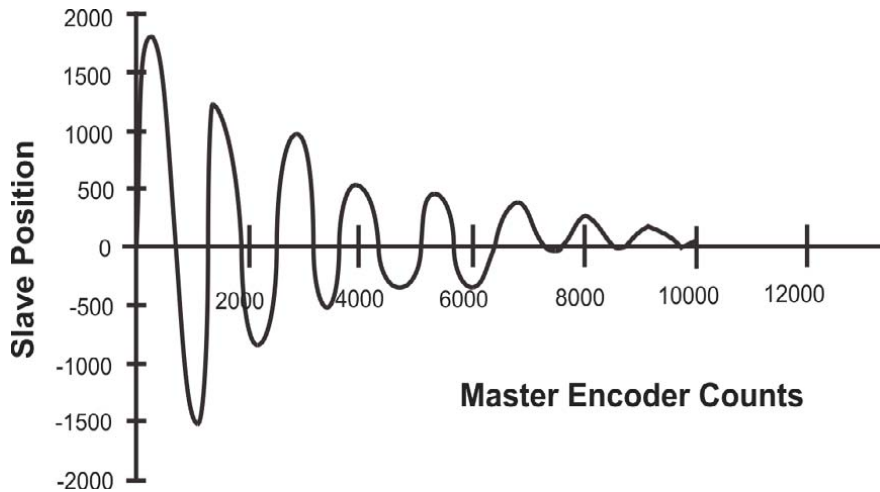

3.12.5 Program

```
'----- Device Params -----_
Params
End Params
'----- Define (dim) Global Variables -----
const MC = 10000 'master counts in total cycle
const NPOINTS = 501 'number of points in cam profile
const pi = 3.1415926535
const k = 0.69314718 / 100
const w = 1 / (7.5 * pi)

'----- Main Program -----
Main
  CAM.ACTIVATE = 0 'Turn off any active cams
  'sets resolution in counts/rev of Virtual Encoder
  FB2.ENCREAS = 2500
  CAM.MASTER = 1 'Master = virtual encoder only
  CAMVM.DIR = 0 'set direction of virtual master
  CAMVM.FREQ = 1000 'set virtual master speed
  call CamCreate_2
  'Generate a cam that does exponentially-
  'damped sinusoidal motion and activate it.
  'Please note that since we are computing
  '500 points of slave profile here several
  'seconds will elapse during the calculation
  'of the cam table.
  call ActivateCam_2
  CAMVM.GOVEL 'virtual master to run at CAMVM.FREQ
  While 1 : Wend
```

```

End Main
'----- Subroutines and Functions -----
Sub CamCreate_2
  'This code creates a cam whose profile
  'is an exponentially damped sine wave.
  dim m, s as float
  dim i as integer
  CAM.CREATE (2,501)
    for i = 0 to NPOINTS-1
      m = i * (MC / (NPOINTS-1)) 'master position
      s = (1 / exp (1.5 * k * i)) * sin (2 * pi * w * i)
      's = computed slave position
      CAM.ADDPOINT(m, 65536 * s)
    Next i
  End
  CAM.CREATE
End Sub
Sub ActivateCam_2
  'Need to disable the drive before changing positions
  DRV.SWENABLE = 0
  MOVE.POSCOMMAND = 0 'Zero out slave position
  EXTENCODER.POSITION = 0 'Zero out real master encoder position
  CAMVM.POSITION = 0 'Zero out virtual master encoder position
  EXTENCODER.POSMODULO = MC 'Set master modulo value
  PL.MODPEN = 1 'Enable slave modulo
  PL.MODP2 = 65536 'Set slave modulo value
  DRV.SWENABLE = 1 'Enable drive
  CAM.ACTIVATE = 2 'Start the cam
End Sub

```

3.12.6 Virtual encoder (virtual master)

The virtual encoder is an internal count generator that is used as the input to the cam. It is controlled much like the profile generator used to control the motion of the motor. The Parameters and statements associated with the virtual encoder are listed below:

CAMVM.DIR
 CAMVM.FREQ
 CAMVM.GOREL
 CAMVM.GOUPDATE
 CAMVM.GOVEL
 CAMVM.MOVING
 CAMVM.POSITION
 CAMVM.RELATIVEDIST
 CAMVM.STOP

3.12.7 Move Parameters

CAMVM.DIR specifies direction for CAMVM.GOVEL
 CAMVM.RELATIVEDIST specifies distance for CAMVM.GOREL
 CAMVM.FREQ specifies speed (frequency) for CAMVM.GOREL and CAMVM.GOVEL

3.12.8 Move Statements

CAMVM.GOREL executes incremental move

CAMVM.GOVEL executes velocity move

CAMVM.GOUPDATE updates move parameters on move in progress

CAMVM.STOP stops motion

3.12.9 Other Variables for Virtual Encoder

CAMVM.POSITION gives the value of the internal counter. This should be set to zero before activating the cam.

CAMVM.MOVING indicates whether a move is in progress

The virtual encoder is used as the input to the cam, either alone (as a virtual master) or in combination with the actual encoder (EXTENCODER.POSITION), to add an offset to the master position. This functionality is controlled by the variable, CAM.MASTER.

FB2.ENCREC (resolution of the external encoder and/or virtual encoder) must be set to a realistic value in counts/rev when using the Virtual Encoder only. When using both the Virtual Encoder and a Real Encoder for the Master Encoder, the Virtual Encoder uses the resolution of the Real Encoder (FB2.ENCREC).

4 Quick Reference: Parameters, Functions, Operators

This section contains the functions, parameters, statements and variables available for AKD BASIC. The tables below list all the parameters that can be called in the program view.

4.1 AKD Parameters and Commands

This table lists the parameters and commands from the AKD Base Drive documentation that are available in AKD BASIC. For detailed descriptions of each parameter click the links below or visit Appendix A of the AKD User Manual.

Parameter or Command	Type	Description
Analog Input (AIN)		
AIN.CUTOFF (pg 142)	NV	Sets the analog input low-pass filter cutoff frequency. (pg 142)
AIN.DEADBAND (pg 143)	NV	Sets the analog input signal deadband. (pg 143)
AIN.DEADBANDMODE (pg 145)	NV	Sets the analog input deadband mode. (pg 145)
AIN.ISCALE (pg 147)	NV	Sets the analog current scale factor. (pg 147)
AIN.MODE (pg 148)	NV	Analog input mode (pg 148)
AIN.OFFSET (pg 150)	NV	Sets the analog input offset. (pg 150)
AIN.PSCALE (pg 151)	NV	Sets the analog position scale factor. (pg 151)
AIN.VALUE (pg 153)	R/O	Reads the value of the analog input signal. (pg 153)
AIN.VSCALE (pg 154)	NV	Sets analog velocity scale factor. (pg 154)
AIN.ZERO (pg 156)	Command	Zeroes the analog input signal. (pg 156)
Analog Input 2 (AIN2)		
AIN2.CUTOFF (pg 158)	NV	Sets the analog input 2 low-pass filter cutoff frequency. (pg 158)
AIN2.DEADBAND (pg 159)	NV	Sets the analog input 2 signal deadband. (pg 159)
AIN2.DEADBANDMODE (pg 160)	NV	Sets the analog input 2 deadband mode. (pg 160)
AIN2.MODE (pg 161)	NV	Analog input 2 mode (pg 161)
AIN2.OFFSET (pg 162)	NV	Sets the analog input 2 offset. (pg 162)
AIN2.VALUE (pg 163)	R/O	Reads the value of the analog input 2 signal. (pg 163)
AIN2.ZERO (pg 164)	Command	Zeroes the analog input 2 signal. (pg 164)
Analog Output (AOUT)		
AOUT.CUTOFF (pg 166)	NV	Sets the analog output low-pass filter cutoff frequency. (pg 166)
AOUT.ISCALE (pg 170)	NV	Sets the analog current scale factor. (pg 170)
AOUT.MODE (pg 171)	NV	Sets the analog output mode. (pg 171)
AOUT.OFFSET (pg 173)	NV	Sets the analog output offset. (pg 173)
AOUT.PSCALE (pg 174)	NV	Sets the analog position scale factor. (pg 174)
AOUT.VALUE (pg 176)	NV	Reads the analog output value. (pg 176)
AOUT.VALUEU (pg 177)	R/W	Sets the analog output value. (pg 177)
AOUT.VSCALE (pg 178)	NV	Sets the velocity scale factor for analog output. (pg 178)
Analog Output 2 (AOUT2)		

Parameter or Command	Type	Description
AOUT2.CUTOFF (pg 181)	NV	Sets the analog output 2 low-pass filter cutoff frequency. (pg 181)
AOUT2.MODE (pg 182)	NV	Sets the analog output 2 mode. (pg 182)
AOUT2.OFFSET (pg 183)	NV	Sets the analog output 2 offset. (pg 183)
AOUT2.VALUE (pg 184)	NV	Reads the analog output 2 value. (pg 184)
AOUT.VALUEEU (pg 185)	R/W	Sets the analog output 2 value. (pg 185)
Capture (CAP)		
CAP0.EDGE, CAP1.EDGE (pg 230)	NV	Selects the capture edge. (pg 230)
CAP0.EN, CAP1.EN (pg 232)	NV	Enables or disables the related capture engine. (pg 232)
CAP0.EVENT, CAP1.EVENT (pg 233)	NV	Controls the precondition logic. (pg 233)
CAP0.FILTER, CAP1.FILTER (pg 237)	R/W	Controls the precondition logic. (pg 233)
CAP0.MODE, CAP1.MODE (pg 238)	NV	Selects the captured value. (pg 238)
CAP0.PLFB, CAP1.PLFB (pg 240)	R/O	Reads captured position value. (pg 240)
CAP0.PREEDGE, CAP1.PREEDGE (pg 242)	NV	Selects the capture precondition edge. (pg 242)
CAP0.PREFILTER, CAP1.PREFILTER (pg 244)	NV	Sets the filter for the precondition input source. (pg 244)
CAP0.PRESELECT, CAP1.PRESELECT (pg 245)	NV	Sets the precondition trigger. (pg 245)
CAP0.STATE, CAP1.STATE (pg 247)	R/O	Indicates whether or not trigger source was captured. (pg 247)
CAP0.T, CAP1.T (pg 248)	R/O	Reads time capture (if time capture was configured). (pg 248)
CAP0.TRIGGER, CAP1.TRIGGER (pg 250)	NV	Specifies the trigger source for the position capture. (pg 250)
Controlled Stop (CS)		
CS.DEC (pg 253)	NV	Sets the deceleration value for the controlled stop process. (pg 253)
CS.STATE (pg 255)	NV	Returns the internal status of the controlled stop process. (pg 255)
CS.TO (pg 256)	NV	Sets the time value for the drive velocity to be within CS.VTHRESH (pg 258). (pg 256)
CS.VTHRESH (pg 258)	NV	Sets the velocity threshold for the controlled stop. (pg 258)
Digital Input (DIN)		
DIN.ROTARY (PG 265)	R/O	Reads the rotary knob value. (pg 265)
DIN.STATES (PG 267)	R/O	Reads the digital input states. (pg 267)
DIN1.FILTER TO DIN7.FILTER (pg 268)	R/W	Filter mode for digital inputs 1 to 7. (pg 268)

Parameter or Command	Type	Description
DIO9.INV to DIO11.INV (pg 283)	R/W	DIO9.INV to DIO11.INV (pg 283)
DIN1.MODE TO DIN7.MODE (pg 272)	NV	Sets the digital input modes. (pg 272)
DIN1.STATE TO DIN7.STATE (pg 274)	R/O	Reads a specific digital input state. (pg 274)
DIN9.STATE to DIN11.STATE (pg 276)	NV	Shows on selected pin if signal is high or low. (pg 276)
DIN21.FILTER to DIN32.FILTER (pg 277)	R/W	Filter mode for digital inputs 21 to 32. (pg 277)
DIN21.STATE to DIN32.STATE (pg 279)	R/O	Reads a specific digital input state. (pg 279)
DIO		
DIO9.INV to DIO11.INV (pg 283)	NV	Inverting the output voltage of the IO, when in the output direction. (pg 283)
DIO9.DIR to DIO11.DIR (pg 282)	NV	Changing direction of the IOs from the X9 connector. (pg 282)
Digital Output (DOUT)		
DOUT.RELAYMODE (pg 286)	R/W	Indicates faults relay mode. (pg 286)
DOUT.STATES (PG 287)	R/O	Reads the state of the digital output(s). (pg 287)
DOUT1.MODE to DOUT2.MODE (pg 288)	NV	Sets the digital output mode. (pg 288)
DOUT1.PARAM AND DOUT2.PARAM (pg 290)	NV	Sets extra parameters for the digital output(s). (pg 290)
DOUT1.STATE AND DOUT2.STATE (pg 292)	R/O	Reads the digital output state. (pg 292)
DOUT1.STATEU AND DOUT2.STATEU (pg 293)	R/W	Sets the state of the digital output node. (pg 293)
DOUT9.STATE to DOUT11.STATE (pg 294)	NV	Shows on selected pin if signal is high or low. (pg 294)
DOUT9.STATEU to DOUT11.STATEU (pg 295)	NV	Allows user to set level of selected pin to high or low. (pg 295)
DOUT21.STATE to DOUT32.STATE (pg 297)	R/O	Reads the digital output state. (pg 297)
DOUT21.STATEU to DOUT32.STATEU (pg 299)	R/W	Sets the state of the digital output node. (pg 299)
Drive (DRV)		
DRV.ACC (pg 303)	NV	Describes the acceleration ramp for the velocity loop. (pg 303)
DRV.ACTIVE (pg 305)	R/O	Reads the enable status of an axis. (pg 305)
DRV.BLINKDISPLAY (PG 306)	Command	Causes the display to blink for 10 seconds. (pg 306)
DRV.CLRFAULT HIST (PG 309)	Command	Clears the fault history log in the NV. (pg 309)

Parameter or Command	Type	Description
DRV.CLRFAULTS (PG 310)	Command	Tries to clear all active faults in the drive. (pg 310)
DRV.CMDSOURCE (PG 312)	NV	Sets the command source (service, fieldbus, analog input, gearing, digital, or Bode). (pg 312)
DRV.DBILIMIT (pg 315)	NV	Sets the maximum amplitude of the current for dynamic braking. (pg 315)
DRV.DEC (pg 316)	NV	Sets the deceleration value for the velocity loop. (pg 316)
DRV.DIR (pg 319)	R/W	Changes drive direction. (pg 319)
DRV.DIS (PG 320)	Command	Disables the axis (software). (pg 320)
DRV.DISSOURCES (PG 323)	R/O	Returns the possible reason for a drive disable. (pg 323)
DRV.DISTO (pg 325)	R/W	Sets the emergency timeout (pg 325).
DRV.EMUJEDIR (pg 327)	R/W	Sets the direction of the emulated encoder output (EEO) signal. (pg 327)
DRV.EMUJEMODE (pg 328)	R/W	Sets the mode of the emulated encoder output (EEO) connector. (pg 328)
DRV.EMUJEMTURN (pg 330)	R/W	Defines the location of the index pulse on the EEO (emulated encoder output) when DRV.EMUJEMODE=2. (pg 330)
DRV.EMUJERES (pg 334)	R/W	Sets the resolution of the EEO (emulated encoder output). (pg 334)
DRV.EMUJZOFFSET (pg 335)	R/W	Sets the location of the EEO (emulated encoder output) index pulse (when DRV.EMUJEMODE=1). (pg 335)
DRV.EN (PG 337)	Command	Enables the axis (software). (pg 337)
DRV.FAULT1 to DRV.FAULT10 (pg 341)	R/O	Location of fault codes for any active fault conditions. (pg 341)
DRV.HANDWHEEL (pg 343)	R/O	Reads the EEO input value. (pg 343)
DRV.HANDWHEELSRC (pg 345)	NV	Selects the feedback for handwheel operation. (pg 345)
DRV.HWENABLE (pg 348)	R/O	Status of the hardware enable. (pg 348)
DRV.ICONT (PG 351)	R/O	Reads the continuous rated current value. (pg 351)
DRV.IPEAK (PG 355)	R/O	Reads the peak rated current value. (pg 355)
DRV.NAME (PG 364)	NV	Sets and reads the name of the drive. (pg 364)
DRV.NVLOAD (pg 367)	W/O	Loads all data from the NV memory of the drive into the RAM parameters. (pg 367)
DRV.NVSAVE (PG 368)	Command	Saves the drive parameters from the RAM to the NV memory. (pg 368)
DRV.OPMODE (PG 370)	NV	Sets the drive operation mode (current, velocity, or position). (pg 370)
DRV.RSTVAR (PG 373)	Command	Sets default values in the drive without re-booting the drive and without resetting the NV memory. (pg 373)
DRV.SETUPREQBITS (pg 375)	R/O	Reads the bitwise set status of parameters that must be set before the drive can be enabled. (pg 375)
DRV.STOP (PG 378)	Command	This command stops all drive motion. (pg 378)
DRV.TIME (pg 381)	R/W	A continuous time counter in the drive. (pg 381)

Parameter or Command	Type	Description
DRV.WARNING1 to DRV.WARNING3 (pg 387)	R/O	Location of fault codes for any active warning conditions. (pg 387)
Fault (FAULT)		
FAULTx.ACTION (pg 407)	R/W	Gets/Sets the Fault Action for Fault 130, 131, 132, 134, 139, 451, and 702. (pg 407)
Feedback 1 (FB1)		
FB1.BISSBITS (PG 410)	NV	Specifies the number of Biss Sensor (Position) Bits for the BiSS Mode C encoder in use. (pg 410)
FB1.ENCRES (PG 411)	NV	Sets the resolution of the motor encoder. (pg 411)
FB1.HALLSTATE (PG 413)	R/O	Reads the Hall switch values (encoder feedback only). (pg 413)
FB1.HALLSTATEU (pg 415)	R/O	Reads the state of Hall switch U. (pg 415)
FB1.HALLSTATEV (pg 416)	R/O	Reads the state of Hall switch V. (pg 416)
FB1.HALLSTATEW (pg 417)	R/O	Reads the state of Hall switch W. (pg 417)
FB1.IDENTIFIED (PG 418)	R/O	Reads the type of feedback device used by the drive/motor. (pg 418)
FB1.INITSIGNED (pg 420)	NV	Sets initial feedback value as signed or unsigned. (pg 420)
FB1.MECHPOS (PG 422)	R/O	Reads the mechanical position. (pg 422)
FB1.MEMVER (PG 423)	R/O	Returns the memory feedback version. (pg 423)
FB1.ORIGIN (pg 428)	NV	Adds to the initial feedback position. (pg 428)
FB1.P (pg 430)	R/O	Reads position from the primary feedback. (pg 430)
FB1.PDIR (pg 431)	NV	Sets the counting direction for feedback channel 1. (pg 431)
FB1.POFFSET (PG 434)	NV	FB1.POFFSET (pg 434)
FB1.POLES (PG 435)	R/O	Reads the number of feedback poles. (pg 435)
FB1.PSCALE (pg 436)	R/W	Sets position scaling value for fieldbus transferred position objects. (pg 436)
FB1.PUNIT (pg 438)	NV	Sets the unit for FB1.P. (pg 438)
FB1.SELECT (PG 441)	NV	Sets user entered type or identified type (-1). (pg 441)
Feedback 2 (FB2)		
FB2.DIR (pg 456)	R/W	FB2.DIR (pg 456)
FB2.ENCRES (pg 451)	NV	Sets the secondary feedback (FB2) resolution (also defines resolution of virtual encoder in AKD BASIC). (pg 451)
FB2.MODE (pg 452)	R/W	Sets the mode for the second feedback inputs, EEO connector (X9) and high speed opto inputs (pins 9 and 10 on X7). (pg 452)
FB2.P (pg 455)	R/O	Reads position from the secondary feedback. (pg 455)
FB2.DIR (pg 456)	NV	Sets the counting direction for feedback channel 2. (pg 456)
FB2.POFFSET (pg 457)	NV	Sets the offset for secondary feedback. (pg 457)
FB2.PUNIT (pg 458)	NV	Sets the unit for FB2.P. (pg 458)
FB2.SOURCE (pg 459)	R/W	Sets the source for the second feedback input. Choices are the EEO connectors (X9) which are RS485 inputs, or the X7 connector's high speed opto inputs (pins 9 and 10). (pg 459)

Parameter or Command	Type	Description
Feedback 3 (FB3)		
FB3.MODE (pg 462)	NV	Selects the type of feedback connected to X9. (pg 462)
FB3.POFFSET (pg 467)	NV	Sets the offset for tertiary feedback. (pg 467)
FB3.PUNIT (pg 468)	NV	Sets the unit for FB3.P. (pg 468)
Hardware Limit Switch (HWLS)		
HWLS.NEGSTATE (pg 482)	R/O	Reads the status of the negative hardware limit switch. (pg 482)
HWLS.POSSTATE (pg 483)	R/O	Reads the status of the positive hardware limit switch. (pg 483)
Current Loop (IL)		
IL.BUSFF (pg 485)	R/O	Displays the current feedforward value injected by the fieldbus. (pg 485)
IL.CMD (PG 486)	R/O	Reads the value of the q-component current command. (pg 486)
IL.CMDU (PG 487)	R/W	Sets the user current command. (pg 487)
IL.DIFOLD (PG 489)	R/O	Reads the drive foldback current limit. (pg 489)
IL.FB (PG 490)	R/O	Reads the actual value of the d-component current. (pg 490)
IL.FF (pg 491)	R/O	Displays the current loop overall feedforward value (pg 491).
IL.FOLDFTHRESH (PG 492)	NV	Reads the foldback fault level. (pg 492)
IL.FOLDWTHRESH (PG 494)	NV	Sets the foldback warning level. (pg 494)
IL.IFOLD (pg 496)	R/O	Reads the overall foldback current limit. (pg 496)
IL.IUFB (PG 497)	R/O	Reads the sigma-delta measured current in the u-winding of the motor. (pg 497)
IL.IVFB (PG 498)	R/W	Sets the sigma-delta measured current in the u-winding of the motor. (pg 498)
IL.KP (PG 501)	NV	Sets the proportional gain of the q-component of the PI regulator. (pg 501)
IL.KPDRATIO (PG 502)	NV	Sets the proportional gain of the d-component current PI-regulator as a percentage of IL.KP (pg 502)
IL.LIMITN (PG 508)	NV	Sets the negative user (application-specific) current limit. (pg 508)
IL.LIMITP (PG 509)	NV	Sets the positive user (application-specific) current limit. (pg 509)
IL.MFOLDD (PG 510)	NV	Sets the motor foldback maximum time at motor peak current. (pg 510)
IL.MFOLDR (PG 511)	R/O	Sets the motor foldback recovery time. (pg 511)
IL.MFOLDT (PG 512)	NV	Sets the motor foldback time constant of the exponential current drop (foldback). (pg 512)
IL.MIFOLD (PG 515)	R/O	Sets the motor foldback current limit. (pg 515)
IL.VCMD (PG 518)	R/O	Sets the output of the q-component PI regulator. (pg 518)
IL.VUFB (PG 519)	R/O	Reads the measured voltage on the u-winding of the motor. (pg 519)
IL.VVFB (PG 520)	R/O	Reads the measured voltage on the v-winding of the motor. (pg 520)
LOAD Parameters		
LOAD.INERTIA (pg 537)	NV	Sets the load inertia. (pg 537)

Motor Parameters		
MOTOR.BRAKE (PG 550)	NV	Sets the presence or absence of a motor brake. (pg 550)
MOTOR.BRAKERLS (pg 553)	Command	Allows a user to release or apply the motor brake. (pg 553)
MOTOR.ICONT (PG 556)	NV	Sets the motor continuous current. (pg 556)
MOTOR.INERTIA (PG 559)	NV	Sets the motor inertia. (pg 559)
MOTOR.IPEAK (PG 560)	NV	Sets the motor peak current. (pg 560)
MOTOR.KE (pg 561)	NV	Sets the motor back EMF constant. (pg 561)
MOTOR.KT (PG 562)	NV	Sets the torque constant of the motor. (pg 562)
MOTOR.LQLL (PG 565)	NV	Sets the line-to-line motor Lq. (pg 565)
MOTOR.NAME (PG 566)	NV	Sets the motor name. (pg 566)
MOTOR.PHASE (PG 567)	NV	Sets the motor phase. (pg 567)
MOTOR.PITCH (PG 570)	NV	Sets the motor pitch. (pg 570)
MOTOR.POLES (PG 571)	NV	Sets the number of motor poles. (pg 571)
MOTOR.R (PG 572)	NV	Sets the stator winding resistance phase-phase in ohms. (pg 572)
MOTOR.TBRAKEAPP (PG 574)	NV	The delay time used for applying the motor brake. (pg 574)
MOTOR.TBRAKERLS (PG 575)	NV	The delay time used for releasing the motor brake. (pg 575)
MOTOR.TEMP (pg 577)	R/O	Reads the motor temperature represented as the resistance of the motor PTC or NTC. (pg 577)
MOTOR.TEMPFAULT (pg 579)	NV	Sets the motor temperature fault level. (pg 579)
MOTOR.TEMPWARN (pg 580)	NV	Sets the motor temperature warning level. (pg 580)
MOTOR.TYPE (PG 581)	NV	Sets the motor type. (pg 581)
MOTOR.VOLTMAX (PG 584)	NV	Sets the motor maximum voltage. (pg 584)
Position Loop (PL)		
PL.CMD (PG 612)	NV	Reads the position command directly from the entry to the position loop. (pg 612)
PL.ERR (PG 613)	NV	Reads the position error present when the drive is controlling the position loop. (pg 613)
PL.ERRFTHRESH (pg 615)	NV	Sets the maximum position error. (pg 615)
PL.ERRMODE (pg 617)	R/W	Sets the type of following error warning and fault usage. (pg 617)
PL.ERRWTHRESH (pg 619)	NV	Sets the position error warning level. (pg 619)

PL.FB (PG 621)	R/O	Reads the position feedback value. (pg 621)
PL.FBSOURCE (pg 623)	NV	Sets the feedback source for the position loop. (pg 623)
PL.INTINMAX (PG 624)	NV	Limits the input of the position loop integrator by setting the input saturation. (pg 624)
PL.INTOUTMAX (PG 626)	NV	Limits the output of the position loop integrator by setting the output saturation. (pg 626)
PL.KI (PG 628)	NV	Sets the integral gain of the position loop. (pg 628)
PL.KP (PG 629)	NV	Sets the proportional gain of the position regulator PID loop. (pg 629)
PL.MODP1 (pg 630)	R/W	Sets modulo range parameter. (pg 630)
PL.MODP2 (pg 632)	R/W	Sets the beginning or end modulo range parameter. (pg 632)
Programmable Limit Switch (PLS)		
PLS.EN (pg 639)	R/W	Enables programmable limit switch (PLS). (pg 639)
PLS.MODE (pg 641)	NV	Selects programmable limit switch mode. (pg 641)
PLS.P1 TO PLS.P8 (pg 643)	NV	Sets the trigger point for programmable limit switches. (pg 643)
PLS.RESET (pg 645)	W/O	Resets programmable limit switch. (pg 645)
PLS.STATE (pg 647)	R/O	Reads the programmable limit switch state. (pg 647)
PLS.T1 TO PLS.T8 (pg 649)	R/W	Sets programmable limit switch time (pg 649).
PLS.UNITS (pg 651)	R/W	Sets programmable limit switch (PLS) units. (pg 651)
PLS.WIDTH1 TO PLS.WIDTH8 (pg 654)	R/W	Programmable Limit Switch Width (pg 654)
Recorder (REC)		
REC.ACTIVE (PG 657)	R/O	Indicates if data recording is in progress (active). (pg 657)
REC.DONE (PG 659)	R/O	Checks whether or not the recorder has finished recording. (pg 659)
REC.OFF (PG 662)	R/W	Turns the recorder OFF. (pg 662)
REC.TRIG (PG 671)	Command	Triggers the recorder. (pg 671)
Regen Resistor (REGEN)		
REGEN.POWER (PG 680)	R/O	READS REGEN RESISTOR'S CALCULATED POWER. (PG 680)
REGEN.REXT (PG 681)	N/V	SETS THE EXTERNAL, USER-DEFINED REGEN RESISTOR RESISTANCE. (PG 681)
REGEN.TEXT (pg 682)	R/W	Sets the external regen resistor thermal protection time constant. (pg 682)
REGEN.TYPE (PG 684)	N/V	SETS THE REGEN RESISTOR TYPE. (PG 684)
REGEN.WATTEXT (PG 685)	R/W	SETS THE REGEN RESISTOR'S POWER FAULT LEVEL FOR AN EXTERNAL REGEN RESISTOR. (PG 685)
SD card (SD)		
SD.LOAD (pg 687)	Command	Loads the drive state (BASIC program and NV parameters) from the SD card to the AKD (AKDs equipped with IO option card only). (pg 687)
SD.SAVE (pg 688)	Command	Saves the drive state (BASIC program and NV parameters) to the SD card (AKDs equipped with IO option card only). (pg 688)

SD.STATUS (pg 689)	R/O	Reads the status of the SD card. (pg 689)
STO		
STO.STATE (pg 704)	R/O	Returns the status of the safe torque off. (pg 704)
SWLS		
SWLS.EN (pg 706)	NV	Enables and disables software travel limit switches. (pg 706)
SWLS.LIMIT0 (pg 708)	NV	Sets the position of the software travel limit switch 0. (pg 708)
SWLS.LIMIT1 (pg 709)	NV	Sets the position of the software travel limit switch 0. (pg 709)
SWLS.STATE (pg 710)	R/O	Reads the actual status of software limit switches. (pg 710)
Units (UNIT)		
UNIT.ACCLINEAR (PG 712)	NV	Sets the linear acceleration/deceleration units. (pg 712)
UNIT.ACCROTARY (PG 713)	NV	Sets the rotary acceleration/deceleration units. (pg 713)
UNIT.LABEL (pg 714)	NV	Sets user-defined name for user-defined position units. (pg 714)
UNIT.PIN (PG 715)	NV	Sets gear IN for the unit conversion. (pg 715)
UNIT.PLINEAR (PG 716)	NV	Sets the linear position units. (pg 716)
UNIT.POUT (PG 717)	NV	Sets gear out for the unit conversion. (pg 717)
UNIT.PROTARY (PG 718)	NV	Sets the position units when the motor type (MOTOR.TYPE (pg 581)) is rotary. (pg 718)
UNIT.VLINEAR (PG 719)	NV	Sets the linear velocity units. (pg 719)
UNIT.VROTARY (PG 720)	NV	Sets the velocity units when the motor type (MOTOR.TYPE (pg 581)) is rotary. (pg 720)
Bus Voltage (VBUS)		
VBUS.OVFTHRESH (pg 724)	R/O	Reads the over voltage fault level. (pg 724)
VBUS.OVWTHRESH (pg 725)	NV	Sets voltage level for over voltage warning. (pg 725)
VBUS.RMSLIMIT (pg 726)	R/O	Reads the limit for the bus capacitors load. (pg 726)
VBUS.UVFTRESH (pg 727)	R/W	Sets the under voltage fault level. (pg 727)
VBUS.UVMODE (pg 728)	NV	Indicates undervoltage (UV) mode. (pg 728)
VBUS.UVWTHRESH (pg 729)	NV	Sets voltage level for undervoltage warning. (pg 729)
VBUS.VALUE (pg 730)	R/O	Reads DC bus voltage. (pg 730)
Velocity Loop (VL)		
VL.ARPF1 TO VL.ARPF4 (pg 732)	R/W	Sets the natural frequency of the pole (denominator) of anti-resonance (AR) filters 1, 2, 3, and 4; active in opmodes 1 (velocity) and 2 (position) only. (pg 732)
VL.ARPQ1 TO VL.ARPQ4 (pg 734)	R/W	Sets the Q of the pole (denominator) of anti-resonance (AR) filter 1; active in opmodes 1 (velocity) and 2 (position) only. (pg 734)
VL.ARTYPE1 TO VL.ARTYPE4 (pg 736)	NV	Indicates the method used to calculate BiQuad coefficients; active in opmodes 1 (velocity) and 2 (position) only. (pg 736)
VL.ARZF1 TO VL.ARZF4 (pg 738)	R/W	Sets the natural frequency of the zero (numerator) of anti-resonance (AR) filter 1; active in opmodes 1 (velocity) and 2 (position) only. (pg 738)

VL.ARZQ1 TO VL.ARZQ4 (pg 740)	R/W	Sets the Q of the zero (numerator) of anti-resonance filter #1; active in opmodes 1 (velocity) and 2 (position) only. (pg 740)
VL.BUSFF (pg 742)	R/O	Displays the velocity loop feedforward value injected by the field-bus; active in opmodes 1 (velocity) and 2 (position) only. (pg 742)
VL.CMD (PG 743)	R/O	Reads the actual velocity command; active in opmodes 1 (velocity) and 2 (position) only. (pg 743)
VL.CMDU (PG 744)	R/W	Sets the user velocity command; active in opmodes 1 (velocity) and 2 (position) only. (pg 744)
VL.ERR (PG 746)	R/O	Sets the velocity error; active in opmodes 1 (velocity) and 2 (position) only. (pg 746)
VL.FB (PG 747)	R/O	Reads the velocity feedback; active in opmodes 1 (velocity) and 2 (position) only. (pg 747)
VL.FBFILTER (pg 748)	R/O	Filters VL.FB (pg 747) value; active in opmodes 1 (velocity) and 2 (position) only. (pg 748)
VL.FBSOURCE (pg 749)	NV	Sets feedback source for the velocity loop; active in opmodes 1 (velocity) and 2 (position) only. (pg 749)
VL.FBUNFILTERED (pg 750)	R/O	Reads the velocity feedback. (pg 750)
VL.FF (pg 751)	R/O	Displays the velocity loop overall feedforward value; active in opmodes 1 (velocity) and 2 (position) only. (pg 751)
VL.GENMODE (PG 752)	NV	Selects mode of velocity generation (Observer, d/dt); active in opmodes 1 (velocity) and 2 (position) only. (pg 752)
VL.KBUSFF (pg 753)	R/W	Sets the velocity loop acceleration feedforward gain value; active in opmodes 1 (velocity) and 2 (position) only. (pg 753)
VL.KI (pg 754)	NV	Sets the velocity loop integral gain for the PI controller; active in opmodes 1 (velocity) and 2 (position) only. (pg 754)
VL.KP (pg 757)	NV	Sets velocity loop proportional gain for the PI controller; active in opmodes 1 (velocity) and 2 (position) only. (pg 757)
VL.KVFF (pg 759)	R/W	Sets the velocity loop velocity feedforward gain value; active in opmodes 1 (velocity) and 2 (position) only. (pg 759)
VL.LIMITN (PG 760)	NV	Sets the velocity lower limit; active in opmodes 1 (velocity) and 2 (position) only. (pg 760)
VL.LIMITP (PG 762)	NV	Sets the velocity high limit; active in opmodes 1 (velocity) and 2 (position) only. (pg 762)
VL.LMJR (pg 764)	R/W	Sets the ratio of the estimated load moment of inertia relative to the motor moment of inertia; active in opmodes 1 (velocity) and 2 (position) only. (pg 764)
VL.THRESH (PG 768)	NV	Sets the user over speed fault level. (pg 768)
Wake and Shake (WS)		
WS.ARM (pg 793)	Command	Sets wake and shake to start at the next drive enable. (pg 793)
WS.DISARM (pg 798)	Command	Cancels ARM requests and resets wake and shake to the IDLE state. (pg 798)
WS.DISTMAX (pg 799)	R/W	Sets maximum movement allowed for wake and shake. (pg 799)
WS.DISTMIN (pg 800)	R/W	Sets the minimum movement required for wake and shake. (pg 800)
WS.IMAX (pg 802)	R/W	Sets maximum current used for wake and shake. (pg 802)
WS.MODE (pg 803)	R/W	Sets the method used for wake and shake. (pg 803)

WS.NUMLOOPS (pg 804)	R/W	Sets the number of repetitions for wake and shake. (pg 804)
WS.STATE (pg 805)	R/O	Reads wake and shake status. (pg 805)
WS.T (pg 806)	R/W	Sets wake and shake current-vector appliance time. (pg 806)
WS.TDELAY1 (pg 807)	NV	Delay for wake and shake timing. (pg 807)
WS.TDELAY2 (pg 808)	NV	Sets the delay for wake and shake timing. (pg 808)
WS.TDELAY3 (pg 809)	NV	Sets the delay for wake and shake between loops in mode 0. (pg 809)
WS.VTHRESH (pg 812)	NV	Defines the maximum allowed velocity for Wake & Shake. (pg 812)

4.2 AKD BASIC Parameters and Commands

The following table lists parameters, commands, functions, and operators unique to AKD BASIC. For detailed descriptions of each parameter click the links below or visit the AKD BASIC Parameters chapter of the AKD BASIC User Manual.

Parameter	Type	Description
Additional Statements		
\$Include (pg 119)	Statement	The \$Include statement allows you to textually include multiple separate files in a single source file. (pg 119)
Alias (pg 120)	Statement	Allows you to define your own names for system resources, such as Input or Output pins. (pg 120)
Call (pg 121)	Statement	Transfer program control to a subroutine. When the subroutine is finished then control is transferred to the line following the CALL. (pg 121)
Cls (pg 122)	Statement	This statement transmits 40 line feed characters (ASCII code = 10) to the serial port. Cls clears the display of a terminal. (pg 122)
Const (pg 123)	Statement	Declares symbolic constants to be used instead of numeric values. (pg 123)
Dim (pg 124)	Statement	Used for declaring variables before use. All variables (except predefined variables) must be declared before they can be used. (pg 124)
Exit (pg 125)	Statement	The Exit statement is used to exit from a subroutine, a function, an interrupt, a For...Next or a While...Wend. (pg 125)
For...Next (pg 126)	Statement	Allows a series of lines to be executed in a loop a specified number of times. (pg 126)
Function (pg 127)	Statement	The Function statement is used to declare and define the name, arguments and type of a user defined function. (pg 127)
GoTo (pg 128)	Statement	GOTO causes the software to jump to the specified label and continue executing from there. (pg 128)
If...Then...Else (pg 129)	Statement	If...Then...Else statements controls program execution based on the evaluation of numeric or string expressions. (pg 129)
Input (pg 130)	Statement	The Input statement reads a character string received from the console tab screen below the program editor window, terminated by a carriage-return. (pg 130)

Parameter	Type	Description
On Error GoTo (pg 131)	Statement	On Error Goto allows you to define a run-time error handler to prevent run-time errors from halting program execution. (pg 131)
Pause() (pg 132)	Statement	Causes the program execution to pause for a specified amount of time. The motion of the motor is not affected. (pg 132)
Print (pg 133)	Statement	Displays formatted output through the console while the program is running. (pg 133)
Restart (pg 134)	Statement	Causes program execution to begin again from the beginning of the program. (pg 134)
Select Case (pg 135)	Statement	Select Case executes one of several statement blocks depending upon the value of an expression. (pg 135)
Static (pg 136)	Statement	Static (pg 136)
Stop (pg 137)	Statement	Stops execution of the user program. (pg 137)
Sub...End Sub (pg 138)	Statement	The Sub statement declares a sub procedure and defines the sub procedures format. (pg 138)
Swap (pg 139)	Statement	Exchanges the value of two variables. (pg 139)
While...Wend (pg 140)	Statement	Executes a series of lines for as long as the condition after the WHILE is True. (pg 140)
BASIC Operators		
AND (pg 105)	Operator	Performs a logical AND operation on two expressions. (pg 105)
BAND (pg 106)	Operator	Performs a bitwise AND of two integer expressions. (pg 106)
BNOT (pg 107)	Operator	Performs a bitwise NOT of the integer expression. (pg 107)
BOR (pg 108)	Operator	Performs a bitwise OR of two integer expressions. (pg 108)
BXOR (pg 109)	Operator	Performs a bitwise XOR of two integer expressions. (pg 109)
MOD (pg 110)	Operator	This is the modulus or "remainder" operator. It divides one number by another and returns the remainder. (pg 110)
NOT (pg 111)	Operator	Performs a logical NOT operation on a boolean expression. (pg 111)
OR (pg 112)	Operator	Performs a logical OR operation on two expressions. (pg 112)
SHL (pg 113)	Operator	Left Shift Operator (pg 113)
SHRA (pg 114)	Operator	Arithmetic Right Shift Operator (pg 114)
SHRA (pg 114)	Operator	Arithmetic Right Shift Operator (pg 114)
XOR (pg 116)	Operator	Performs a logical XOR operation on two expressions. (pg 116)
BASIC Functions		
ABS() (pg 72)	Function	ABS(x) converts the associated value (x) to an absolute value. If the value is negative, it is converted to a positive value. If the value is positive, it is not changed. (pg 72)
ASC() (pg 73)	Function	ASC(string expression) returns a decimal numeric value that is the ASCII code for the first character of the string expression(x\$). (pg 73)

Parameter	Type	Description
ATAN() (pg 74)	Function	ATAN() (arc tangent) returns the arctangent of its argument in radians. (pg 74)
CHR\$() (pg 75)	Function	Returns a one character string whose ASCII value is the argument. (pg 75)
CINT() (pg 76)	Function	Converts a numeric expression to the closest integer number. (pg 76)
COS() (pg 77)	Function	COS(x) returns the cosine of x, where x is in radians. (pg 77)
EXP() (pg 78)	Function	Returns e (the base of natural logarithms) raised to a power. (pg 78)
FIX() (pg 79)	Function	Fix() returns the truncated integer part of x. (pg 79)
HEX\$() (pg 80)	Function	HEX\$() converts an integer number to its equivalent hexadecimal ASCII string. (pg 80)
INKEY\$() (pg 81)	Function	Returns a 1 character string corresponding to the character in the serial port receive buffer. If there is no character waiting the INKEY\$ will be the Null string (""). If several characters are pending only the first one is returned. (pg 81)
INSTR() (pg 82)	Function	Returns the starting location of a substring within a string. (pg 82)
INT() (pg 83)	Function	INT() (convert to largest integer) truncates an expression to a whole number. (pg 83)
LCASE\$() (pg 84)	Function	Converts a string expression to lowercase characters. (pg 84)
LEFT\$() (pg 85)	Function	Returns a string of the n leftmost characters in a string expression. (pg 85)
LEN() (pg 86)	Function	Returns the number of characters in a string expression. (pg 86)
LOG() (pg 87)	Function	Returns the natural logarithm of a numeric expression. (pg 87)
LOG10() (pg 88)	Function	Returns the base 10 logarithm of a numeric expression. (pg 88)
LTRIM\$() (pg 89)	Function	Returns a copy of the original string with leading blanks removed. (pg 89)
MID\$() (pg 90)	Function	Returns a substring of the original string that begins at the specified offset location and is of the specified (optional) length. (pg 90)
OCT\$() (pg 91)	Function	OCT\$() converts an integer number to its equivalent octal ASCII string. (pg 91)
RIGHT\$() (pg 92)	Function	Returns a string of the n rightmost characters in a string expression. (pg 92)
RTRIM\$() (pg 93)	Function	Returns a copy of the original string with trailing blanks removed. (pg 93)
SGN() (pg 94)	Function	Returns the sign of a numeric expression. (pg 94)
SIN() (pg 95)	Function	SIN(x) returns the sine of x, where x is in radians. (pg 95)
SPACE\$() (pg 96)	Function	Returns a string of n spaces. (pg 96)
SQRT() (pg 97)	Function	Returns the square root of a numeric expression. (pg 97)

Parameter	Type	Description
STR\$() (pg 98)	Function	Returns a string representing the value of a numeric expression. (pg 98)
STRING\$() (pg 99)	Function	Returns a string containing the specified number of occurrences of the specified character. (pg 99)
TAN() (pg 100)	Function	TAN(x) returns the tangent of x, where x is in radians. (pg 100)
TRIM\$() (pg 101)	Function	Returns a copy of the original string with leading and trailing blanks removed. (pg 101)
UCASE\$() (pg 102)	Function	Converts a string expression to uppercase characters. (pg 102)
VAL() (pg 103)	Function	Returns the numerical value of a string. (pg 103)
Camming (CAM)		
CAM.ACTIVATE (pg 210)	Statement	Activates the specified cam table. (pg 210)
CAM.ADDPOINT (pg 212)	Statement	CAM.ADDPOINT(Master Position, Slave Position) Adds the specified "point" to the cam table being created. (pg 212)
CAM.CORRECTDIR (pg 214)	R/W	Specifies the direction of the correction move when a new cam table is activated (set CAM.ACTIVATE = n) or when speed synchronization is achieved. (pg 214)
CAM.CREATE (pg 215)	Statement	CAM.CREATE (x, y) Initiates the creation of a cam table. (pg 215)
CAM.MASTER (pg 217)	R/W	Specifies the source of the input to the cam table for cam profiling. (pg 217)
CAM.MASTERPOS (pg 218)	R/O	Gives the value of the master position presently being used as the input to the cam table. (pg 218)
CAM.SLAVEOFFSET (pg 219)	R/O	CAM.SLAVEOFFSET indicates the offset (or difference) between MOVE.POSCOMMAND and the position command that is calculated from the active cam table based upon the present value of EXTENCODER.POSITION and/or CAMVM.POSITION. (pg 219)
CAMVM.DIR (pg 220)	R/W	Specifies the direction the virtual encoder goes when CAMVM.GOVEL is executed. (pg 220)
CAMVM.FREQ (pg 221)	R/W	CAMVM.FREQ sets the maximum frequency allowed during a relative (CAMVM.GOREL) move, and sets the commanded speed during a velocity move (CAMVM.GOVEL) (pg 221)
CAMVM.GOREL (pg 222)	Statement	Makes the virtual master move the distance specified by CAMVM.RELATIVEDIST. (pg 222)
CAMVM.GOUPDATE (pg 223)	Statement	Updates a move in progress with new move parameters. (pg 223)
CAMVM.GOVEL (pg 224)	Statement	CAMVM.GOVEL (Go at Velocity) causes the virtual master to move continuously at the frequency specified by CAMVM.FREQ in the direction (positive or negative) specified by CAMVM.DIR. The frequency or direction is modified during the move using CAMVM.GOUPDATE. (pg 224)
CAMVM.MOVING (pg 225)	R/O	Indicates if the virtual encoder is moving. (pg 225)

Parameter	Type	Description
CAMVM.POSITION (pg 226)	R/W	Contains the current value of the virtual encoder counter. (pg 226)
CAMVM.RELATIVEDIST (pg 227)	R/W	Specifies the number or counts that the virtual encoder (virtual master) will put out during an incremental move (CAMVM.GOREL). (pg 227)
CAMVM.STOP (pg 228)	Statement	CAMVM.STOP stops the virtual encoder (pg 228)
Drive (DRV)		
DRV.SWENABLE (pg 379)	R/W	Controls whether power can flow to the motor. (pg 379)
Electronic Gearing (EGEAR)		
EGEAR.ACCLIMIT (pg 391)	R/W	EGEAR.ACCLIMIT sets the maximum acceleration. (pg 391)
EGEAR.DECLIMIT (pg 393)	R/W	EGEAR.DECLIMIT sets the maximum deceleration that will be commanded on the follower when EGEAR.ON is turned OFF or the electronic gearing ratio (EGEAR.RATIO or EGEAR.PULSESOUT / EGEAR.PUSLESIN) is decreased. (pg 393)
EGEAR.ERROR (pg 395)	R/W	Indicates the amount of position deviation that has accumulated on the slave axis (in an electronic gearing application) as a result of the slave axis limiting its acceleration or deceleration while achieving velocity synchronization. (pg 395)
EGEAR.LOCK (pg 396)	R/O	EGEAR.LOCK indicates when the slave axis (follower axis) in an electronic gearing application has achieved velocity synchronization with the electronic gearing master. (pg 396)
EGEAR.ON (pg 397)	Command	Starts the electronic gearing; active in opmode 2 (position) only. (pg 397)
EGEAR.PULSESIN (pg 398)	R/W	Specifies the number of encoder counts used when specifying an exact electronic gearing ratio. (pg 398)
EGEAR.PULSESOUT (pg 399)	R/W	Specifies the number of position counts used in an exact electronic gearing ratio. (pg 399)
EGEAR.RATIO (pg 400)	R/W	Sets the electronic gearing ratio (rev to rev) between the encoder shaft (master) and the motor shaft (slave). (pg 400)
EGEAR.TYPE (pg 401)	R/W	Sets the allowed direction of motion for electronic gearing. (pg 401)
External Encoder (EXTENCODER)		
EXTENCODER.FREQ (pg 403)	R/O	Gets the external encoder (EEO) velocity. (pg 403)
EXTENCODER.POSITION (pg 404)	R/O	Gets the external encoder (EEO) position. (pg 404)
EXTENCODER.POSMODULO (pg 405)	R/W	Sets/gets the external encoder (EEO) modulo position. (pg 405)
Interrupt (INTR)		
Interrupt...End Interrupt (pg 535)	Statement	The interrupt feature permits execution of a user-defined subroutine upon receipt of a hardware interrupt signal or a pre-defined interrupt event. (pg 535)

Parameter	Type	Description
INTR.DIN1HI (pg 533)		Enables interrupt for when DIN1.STATE to DIN7.STATE goes from 0 to 1, respectively.
INTR.DIN1LO (pg 533)		Enables interrupt for when DIN1.STATE to DIN7.STATE goes from 1 to 0, respectively.
INTR.DISABLE (pg 534)		Enables interrupt for when the drive gets disabled.
INTR.DRV.FAULTS (pg 534)		Enables interrupt for when the drive faults.
INTR.DRV.HWENABLE (pg 534)		Enables interrupt for when DRV.HWENABLE goes from 0 to 1.
INTR.DRV.WARNINGS (pg 534)		Enables interrupt for when the drive produces a warning.
INTR.HWLS.NEGSTATE (pg 534)		Enables interrupt for when HWLS.NEGSTATE goes from 0 to 1.
INTR.HWLS.POSSTATE (pg 534)		Enables interrupt for when HWLS.POSSTATE goes from 0 to 1.
INTR.MOVBUS (pg 534)		Enables interrupt for when a Modbus User Parameter changes.
INTR.PL.ERR (pg 534)		Enables interrupt for when PL.ERR = PL.ERRFTHRESH.
INTR.PLS.P1 to INTR.PLS.P8 (pg 534)		Enables interrupt for when PLS1 to PLS8 is enabled and goes high, respectively.
INTR.SWLS.LIMIT0 (pg 534)		Enables interrupt for when PL.FB > SWLS.LIMIT0 (if SWLS.LIMIT0 is the upper limit)
INTR.SWLS.LIMIT1 (pg 534)		Enables interrupt for when PL.FB < SWLS.LIMIT1 (if SWLS.LIMIT1 is the lower limit)
INTR.TIMER (pg 534)		Executes interrupt after a number of milliseconds specified by VM.INTRTIMER.
MODBUS Parameters		
MODBUS.PIN (pg 539)	R/W	Gets / Sets the Modbus User Units Input parameter.
MODBUS.POUT (pg 541)	R/W	Gets / Sets the Modbus User Units Output parameter.
MODBUS.PSCALE (pg 543)	R/W	Gets/Sets the Feedback Resolution (per rev) over Modbus.
MODBUS.SCALING (pg 545)	NV	Selects the scaling mode for Modbus values.
Move Parameters (MOVE)		
MOVE.ABORT (pg 590)	Command	MOVE.ABORT stops motor motion and allows continued program execution. (pg 590)
MOVE.ACC (pg 591)	R/W	Sets the maximum commanded acceleration rate when the speed is increased. (pg 591)
MOVE.DEC (pg 593)	R/W	Sets the maximum commanded deceleration rate when the speed is decreased. (pg 593)
MOVE.DIR (pg 595)	R/W	MOVE.DIR specifies the direction the motor turns when a MOVE.GOVEL statement is executed. (pg 595)
MOVE.GOABS (pg 597)	Command	MOVE.GOABS moves the motor to the position specified by MOVE.TARGETPOS. (pg 597)
MOVE.GOHOME (pg 598)	Command	MOVE.GOHOME causes the motor to move to the position specified where PL.FB = 0. (pg 598)
MOVE.GOREL (pg 599)	Command	MOVE.GOREL moves the motor a distance specified by MOVE.RELATIVEDIST. (pg 599)

Parameter	Type	Description
MOVE.GOUPDATE (pg 600)	Command	MOVE.GOUPDATE updates a move in progress with new move parameters. (pg 600)
MOVE.GOVEL (pg 601)	Command	MOVE.GOVEL moves the motor at a constant speed specified by MOVE.RUNSPEED and direction specified by MOVE.DIR. (pg 601)
MOVE.INPOSITION (pg 602)	R/O	Indicates whether or not the motor has achieved command position. (pg 602)
MOVE.INOSLIMIT (pg 603)	R/W	Specifies the tolerance of Position Error (PL.ERR) within which the MOVE.INPOSITION flag will be set to 1 (True). (pg 603)
MOVE.MOVING (pg 604)	R/O	Indicates whether or not the commanded motion profile is complete. (pg 604)
MOVE.POSCOMMAND (pg 605)	R/W	Current Position Command from Trajectory Generator. (pg 605)
MOVE.RELATIVEDIST (pg 606)	R/W	Specifies the distance the motor turns during a relative move (MOVE.GOREL). (pg 606)
MOVE.RUNSPEED (pg 607)	R/W	Sets the maximum speed allowed during a relative (MOVE.GOREL) or absolute (MOVE.GOABS) move, and sets the commanded speed during a velocity move (MOVE.GOVEL). (pg 607)
MOVE.SCURVETIME (pg 608)	R/W	Sets the amount of S-curve smoothing applied to all velocity profiles. (pg 608)
MOVE.TARGETPOS (pg 609)	R/W	MOVE.TARGETPOS specifies the target position for an absolute (MOVE.GOABS) move. (pg 609)
MOVE.VCMD (pg 610)	R/O	Trajectory Generator Velocity Command. (pg 610)
Virtual Machine (VM)		
VM.AUTOSTART (pg 772)	R/W	VM.AUTOSTART specifies whether or not the program in the AKD BASIC starts executing automatically when AC power is applied. (pg 772)
VM.PGMCOMPILERVERSION (pg 776)	R/O	Returns the compiler version of the most recent BASIC program downloaded to the drive.
VM.ERR (pg 773)	R/W	Indicates what caused the most recent Runtime Error. (pg 773)
VM.INTRTIMER (pg 775)	R/W	Sets a number of milliseconds before INTR.TIMER executes after it is called. (pg 775)
VM.PGMERRORLIST (pg 777)	R/O	Returns a list of unsupported items from the most recent BASIC program downloaded to the drive.
VM.RESTART (pg 778)	Command	Causes program execution to start again from the beginning of the program. (pg 778)
VM.START (pg 779)	Command	Starts program execution if program has been stopped. (pg 779)
VM.STATE (pg 780)	R/O	Returns the state of the AKD Virtual Machine. (pg 780)
VM.STOP (pg 781)	Command	Stops Execution of the program (pg 781)
WHEN		
When (pg 783)	Statement	The When statement is used for very fast response to certain input conditions. (pg 783)
When Conditions		
PL.FB < value		

Parameter	Type	Description
PL.FB > value		
PL.CMD < value		
PL.CMD > value		
DRV.HANDWHEEL < value		
DRV.HANDWHEEL > value		
DRV.TIME > value		
DINx.STATE = 0 or 1		
FB3.P < value		
FB3.P > value		
MOVE.MOVING = 0 or 1		
MOVE.INPOSITION = 0 or 1		
When Actions		
Continue		
CAMVM.GOREL		
CAMVM.GOUPDATE		
CAMVM.GOVEL		
CAMVM.STOP		
DOUT1.STATEU = 0 or 1		
DOUT2.STATEU = 0 or 1		
EGEAR.RATIO = value		
MOVE.ABORT		
MOVE.GOABS		
MOVE.GOREL		
MOVE.GOVEL		
MOVE.GOABSREG		
MOVE.GOHOME		
MOVE.GORELREG		
MOVE.GOUPDATE		
WHEN.DRVHANDWHEEL (pg 786)	R/O	Records the value of DRV.HANDWHEEL when the when-condition is satisfied. (pg 786)
WHEN.DRVTIME (pg 787)	R/O	Records the value of Time when the when-condition is satisfied. (pg 787)
WHEN.FB1MECHPOS (pg 788)	R/O	Records the value of FB1.MECHPOS when the when-condition is satisfied. (pg 788)
WHEN.FB3P (pg 789)	R/O	Records the value of FB3.P when the when-condition is satisfied. (pg 789)
WHEN.PLCMD (pg 790)	R/O	Records the value of PL.CMD when the when-condition is satisfied. (pg 790)
WHEN.PLFB (pg 791)	R/O	Records the value of Position when the when-condition is satisfied. (pg 791)

5 AKD BASIC Functions

This section describes the functions available in AKD BASIC.

5.1	ABS()	72
5.2	ASC()	73
5.3	ATAN()	74
5.4	CHR\$()	75
5.5	CINT()	76
5.6	COS()	77
5.7	EXP()	78
5.8	FIX()	79
5.9	HEX\$()	80
5.10	INKEY\$()	81
5.11	INSTR()	82
5.12	INT()	83
5.13	LCASE\$()	84
5.14	LEFT\$()	85
5.15	LEN()	86
5.16	LOG()	87
5.17	LOG10()	88
5.18	LTRIM\$()	89
5.19	MID\$	90
5.20	OCT\$()	91
5.21	RIGHT\$()	92
5.22	RTRIM\$()	93
5.23	SGN()	94
5.24	SIN()	95
5.25	SPACE\$()	96
5.26	SQRT()	97
5.27	STR\$()	98
5.28	STRING\$()	99
5.29	TAN()	100
5.30	TRIM\$()	101
5.31	UCASE\$()	102
5.32	VAL()	103

5.1 ABS()

General Information	
Type	Function
Description	ABS(x) converts the associated value (x) to an absolute value. If the value is negative, it is converted to a positive value. If the value is positive, it is not changed.

Instructions

Enter the argument (the value) in parentheses immediately following the term ABS.

Example

```
For x = -10 To 10
  Print ABS(x)
Next
```

5.2 ASC()

General Information	
Type	Function
Description	ASC(string expression) returns a decimal numeric value that is the ASCII code for the first character of the string expression(x\$).

Syntax

x = ASC(s\$)

Instructions

If the string begins with an uppercase letter, the value of ASC() will be between 65 and 90.

If the string begins with a lowercase letter, the value of ASC() will be between 97 and 122.

Values "0" to "9" return 48 to 57.

5.3 ATAN()

General Information	
Type	Function
Description	ATAN() (arc tangent) returns the arctangent of its argument in radians.

Instructions

The result is always between $-\pi/2$ and $\pi/2$.

The value of x may be any numeric type.

To convert from degrees to radians, multiply by 0.01745329

5.4 CHR\$()

General Information	
Type	Function
Description	Returns a one character string whose ASCII value is the argument.

Syntax

s\$ = CHR\$(x)

Instructions

The argument to Chr\$() must be a numeric value in the range 0 to 255.

Example

```
'this example will print an uppercase B  
Dim a$ as string  
a$ = CHR$(66)  
Print a$
```

5.5 CINT()

General Information	
Type	Function
Description	Converts a numeric expression to the closest integer number.

Instructions

X = CINT(numeric-expression)

Related Topics

INT() (pg 83) | FIX() (pg 79)

5.6 COS()

General Information	
Type	Function
Description	COS(x) returns the cosine of x, where x is in radians.

Instructions

X must be in radians. To convert from degrees to radians, multiply by 0.017453.

5.7 EXP()

General Information	
Type	Function
Description	Returns e (the base of natural logarithms) raised to a power.

Instructions

The Exp() function complements the action of the Log() function. For those of you keeping score, the value of e is 2.71828182.

Related Topics

LOG() (pg 87) | LOG10() (pg 88)

5.8 FIX()

General Information	
Type	Function
Description	Fix() returns the truncated integer part of x.

Instructions

Fix() does not round off numbers, it simply eliminates the decimal point and all digits to the right of the decimal point.

Related Topics

ABS() (pg 72) | CINT() (pg 76) | INT() (pg 83)

5.9 HEX\$()

General Information	
Type	Function
Description	HEX\$() converts an integer number to its equivalent hexadecimal ASCII string.

Syntax

result\$ = HEX\$(x)

Instructions

Hexadecimal numbers are numbers to the base 16 (rather than base 10).

The argument to HEX\$() is rounded to an integer before HEX\$(x) is evaluated.

Example

```
Dim x,y as integer
Dim result1$, result2$ as string
x = 20
y = $H6A
result1$ = HEX$(x)
result2$ = HEX$(y)
Print result1$, result2$
'prints 14 6A
```

Related Topics

OCT\$() (pg 91) | STR\$() (pg 98)

5.10 INKEY\$()

General Information	
Type	Function
Description	Returns a 1 character string corresponding to the character in the serial port receive buffer. If there is no character waiting the INKEY\$ will be the Null string (""). If several characters are pending only the first one is returned.

Syntax

x\$ = INKEY\$

Instructions

Assigning a string from INKEY\$ removes the character from the serial port's receive buffer.

Example

```
' remove all characters from the receive buffer and put them into
'A$.
new$ = INKEY$
While new$ <> ""
    A$ = A$ + new$
    new$ = INKEY$
Wend
```

5.11 INSTR()

General Information	
Type	Function
Description	Returns the starting location of a substring within a string.

Syntax

result = INSTR([n], x\$, y\$)

x\$ is the string

y\$ is the substring

n optionally sets the start of the search

Instructions

n must be in the range 1 to 255

INSTR() returns 0 if:

n > LEN(x\$)

y\$ cannot be found in x\$

If y\$ is null (empty, ""), INSTR() returns n

Related Topics

LEN() (pg 86)

5.12 INT()

General Information	
Type	Function
Description	INT() (convert to largest integer) truncates an expression to a whole number.

Instructions

INT() behaves the same as FIX() for positive numbers. They behave differently for negative numbers.

Example

```
Print INT(12.34) 'prints the value 12  
Print INT(-12.34) 'prints the value -13
```

Related Topics

CINT() (pg 76) | FIX() (pg 79)

5.13 LCASE\$()

General Information	
Type	Function
Description	Converts a string expression to lowercase characters.

Syntax

result\$ = LCASE\$(string-expression)

Instructions

LCASE\$() affects only letters in the string expression. Other characters (such as numbers) are not changed.

Example

```
Dim x$ as string
x$ = "U.S.A"
Print LCASE$(x$) 'prints: u.s.a
```

Related Topics

UCASE\$() (pg 102)

5.14 LEFT\$()

General Information	
Type	Function
Description	Returns a string of the n leftmost characters in a string expression.

Syntax

```
result$ = LEFT$(x$, n)
```

Instructions

If n is greater than LEN(x\$) then the entire string will be returned.

Example

```
a$ = "Mississippi"  
Print LEFT$(a$, 5) 'prints: Missi
```

Related Topics

LEN() (pg 86) | MID\$ (pg 90) | RIGHT\$() (pg 92)

5.15 LEN()

General Information	
Type	Function
Description	Returns the number of characters in a string expression.

Syntax

```
result = Len( x$ )
```

Instructions

Non-printing characters and blanks are included.

Example

```
x$ = "New York, New York"  
Print LEN(x$) 'prints 18
```

5.16 LOG()

General Information	
Type	Function
Description	Returns the natural logarithm of a numeric expression.

Instructions

X must be greater than 0.

Example

```
Print LOG (45.0 / 7.0) 'prints 1.860752  
Print LOG(1) 'prints 0
```

Related Topics

EXP() (pg 78) | LOG10() (pg 88)

5.17 LOG10()

General Information	
Type	Function
Description	Returns the base 10 logarithm of a numeric expression.

Instructions

X must be greater than 0.

Example

```
Print LOG10(100) 'prints 2  
Print LOG10(1) 'prints 0
```

Related Topics

EXP() (pg 78) | LOG() (pg 87)

5.18 LTRIM\$()

General Information	
Type	Function
Description	Returns a copy of the original string with leading blanks removed.

Syntax

result\$ = LTRIM\$(x\$)

Instructions

x\$ can be any string-expression

Example

```
x$ = "   Hello   "  
Print "(" + LTRIM$(x$) + ")"  
'prints: (Hello   )
```

Related Topics

RTRIM\$(pg 93) | TRIM\$(pg 101)

5.19 MID\$

General Information	
Type	Function
Description	Returns a substring of the original string that begins at the specified offset location and is of the specified (optional) length.

Syntax

```
result = MID$(x$, start, [length])
```

Instructions

Start and Length must both be numeric expressions.

If Length is omitted then MID\$() returns a substring that starts at start and goes to the end of x\$.

Example

```
x$ = "abcdefghi"  
Print MID$(x$, 1, 5) 'prints: abcde  
Print MID$(x$, 6) 'prints: fghi
```

Related Topics

INSTR() (pg 82) | LEFT\$() (pg 85) | LEN() (pg 86) | RIGHT\$() (pg 92)

5.20 OCT\$()

General Information	
Type	Function
Description	OCT\$() converts an integer number to its equivalent octal ASCII string.

Syntax

result\$ = OCT\$(x)

Instructions

Octal numbers are numbers to the base 8 (rather than base 10).

The argument to HEX\$() is rounded to an integer before OCT\$(x) is evaluated.

Example

```
Dim x, y as integer
Dim result1$, result2$ as string

x = 20
y = &H6A
result1$ = OCT$(x)
result2$ = OCT$(y)
print result1$, result2$ 'prints: 24 152
```

Related Topics

HEX\$() (pg 80) | STR\$() (pg 98)

5.21 RIGHT\$()

General Information	
Type	Function
Description	Returns a string of the n rightmost characters in a string expression.

Syntax

```
result$ = RIGHT$(x$, n)
```

Instructions

If n is greater than Len(x\$) then the entire string will be returned.

Example

```
a$ = "Mississippi"  
Print RIGHT$(a$, 5) 'prints: sippi
```

Related Topics

LEN() (pg 86) | MID\$ (pg 90) | LEFT\$() (pg 85)

5.22 RTRIM\$()

General Information	
Type	Function
Description	Returns a copy of the original string with trailing blanks removed.

Syntax

result\$ = RTRIM\$(x\$)

Instructions

x\$ can be any string-expression.

Example

```
x$ = "    Hello    "  
Print "(" + RTRIM$(x$) + ")"  
'prints: (    Hello)
```

Related Topics

LTRIM\$(pg 89) | TRIM\$(pg 101)

5.23 SGN()

General Information	
Type	Function
Description	Returns the sign of a numeric expression.

Instructions

X is any numeric expression

Example

```
Print SGN(-33) 'prints -1  
Print SGN(0) 'prints 0  
Print SGN(45.77) 'prints 1
```

5.24 SIN()

General Information	
Type	Function
Description	SIN(x) returns the sine of x, where x is in radians.

Instructions

X must be in radians. To convert from degrees to radians, multiply by 0.017453.

5.25 SPACE\$()

General Information	
Type	Function
Description	Returns a string of n spaces.

Syntax

result\$ = SPACE\$(n)

n is 0 to 255

Instructions

N is rounded to an integer before SPACE\$() is evaluated.

Example

```
x$ = "(" + SPACE$(1) + "hello" + SPACE$(4) + ")"  
Print x$  
'prints: ( hello   )'
```

Related Topics

STRING\$() (pg 99)

5.26 SQRT()

General Information	
Type	Function
Description	Returns the square root of a numeric expression.

Instructions

X must be greater than or equal to zero.

Example

```
x = 10
print SQRT(x) 'prints 3.162278
```

5.27 STR\$()

General Information	
Type	Function
Description	Returns a string representing the value of a numeric expression.

Syntax

result\$ = STR\$(x)

Instructions

Enter a numeric expression as x and STR\$ will return its result as a string.

Example

```
x = 45.2 / 7  
Print STR$(x) 'prints: 6.457'
```

Related Topics

HEX\$() (pg 80) | OCT\$() (pg 91)

5.28 STRING\$()

General Information	
Type	Function
Description	Returns a string containing the specified number of occurrences of the specified character.

Syntax

1) x\$ = STRING\$(n, a\$)

or

2) x\$ = STRING\$(n, m)

Instructions

n is the number of occurrences of the desired character (the length of the returned string).

In 1), the returned string will consist of the first character in a\$

In 2), the returned string will consist of the ASCII value of m.

Example

```
Print String$(5, 45) 'prints: -----
Print String$(5, "A") 'prints: AAAAA
```

Related Topics

SPACE\$() (pg 96)

5.29 TAN()

General Information	
Type	Function
Description	TAN(x) returns the tangent of x, where x is in radians.

Instructions

X must be in radians. To convert from degrees to radians, multiply by 0.017453.

5.30 TRIM\$()

General Information	
Type	Function
Description	Returns a copy of the original string with leading and trailing blanks removed.

Syntax

result\$ = TRIM\$(x\$)

Instructions

x\$ can be any string-expression

Example

```
x$ = "    Hello    "  
Print "(" + TRIM$(x$) + ")"  
'prints: (Hello)
```

Related Topics

LTRIM\$() (pg 89) | RTRIM\$() (pg 93)

5.31 UCASE\$()

General Information	
Type	Function
Description	Converts a string expression to uppercase characters.

Syntax

result\$ = UCASE\$(string-expression)

Instructions

UCASE\$() affects only letters in the string expression. Other characters (such as numbers) are not changed.

Example

```
Dim x$ as string
x$ = "u.s.a"
Print UCASE$( x$) 'prints: U.S.A
```

Related Topics

LCASE\$() (pg 84)

5.32 VAL()

General Information	
Type	Function
Description	Returns the numerical value of a string.

Syntax

result = VAL(a\$)

Instructions

If the first character of a\$ is not numeric then Val() will return 0.

Related Topics

STR\$() (pg 98)

6 Operators

This section describes the details of some operators available in AKD BASIC.

6.1 AND	105
6.2 BAND	106
6.3 BNOT	107
6.4 BOR	108
6.5 BXOR	109
6.6 MOD	110
6.7 NOT	111
6.8 OR	112
6.9 SHL	113
6.10 SHRA	114
6.11 SHRL	115
6.12 XOR	116

6.1 AND

General Information	
Type	Operator
Description	Performs a logical AND operation on two expressions.

Syntax

result = A AND B

Instructions

The result evaluates to True if, and only if, both expressions are True. Otherwise, the result is False.

Example

```
x = 17
y = 27
if (x > 20) AND (y > 20) then
    print "This won't get printed"
end if
if (x < 20) AND (y > 20) then
    print "This will get printed"
end if
```

6.2 BAND

General Information	
Type	Operator
Description	Performs a bitwise AND of two integer expressions.

Syntax

result = x BAND y

Instructions

The Band operator performs a bitwise And operation on the two numeric expressions. The expressions are converted to integers (32 bits) before the Band operation takes place.

For each of the 32 bits in the result, the bit will be set to 1 if, and only if, the corresponding bit in both of the arguments is 1.

Example

```
x = 45 '0010 1101 binary
y = 99 '0110 0011 binary
print x BAND y 'prints: 33 (0010 0001)
```

6.3 BNOT

General Information	
Type	Operator
Description	Performs a bitwise NOT of the integer expression.

Syntax

result = Bnot x

Instructions

The Bnot operator performs a bitwise NOT operation on a numeric expression. The expression is converted to an integer (32 bits) before the BNOT operation takes place.

For each of the 32 bits in the result, the bit will be set to 1 if the corresponding bit in the argument is 0; the bit will be set to 0 if the corresponding bit in the argument is 1.

Example

```
x = 45 '0010 1101 binary
print BNOT x 'prints: -46
```

6.4 BOR

General Information	
Type	Operator
Description	Performs a bitwise OR of two integer expressions.

Syntax

result = x BOR y

Instructions

The Bor operator performs a bitwise OR operation on the two numeric expressions. The expressions are converted to integers (32 bits) before the BOR operation takes place.

For each of the 32 bits in the result, the bit will be set to 1 if the corresponding bit in either of the arguments is 1.

Example

```
x = 45 '0010 1101 binary
y = 99 '0110 0011 binary
print x BOR y 'prints: 111(0110 1111)
```

6.5 BXOR

General Information	
Type	Operator
Description	Performs a bitwise XOR of two integer expressions.

Syntax

result = x BXOR y

Instructions

The Bxor operator performs a bitwise XOR operation on the two numeric expressions. The expressions are converted to integers (32 bits) before the BXOR operation takes place.

For each of the 32 bits in the result, the bit will be set to 1 if the corresponding bits in the two arguments are different from each other. If the corresponding bits are identical (both 0 or both 1), then the bit will be set to 0.

Example

```
x = 45 '0010 1101 binary
y = 99 '0110 0011 binary
print x BXOR y 'prints: 78 (0100 1110)
```

6.6 MOD

General Information	
Type	Operator
Description	This is the modulus or "remainder" operator. It divides one number by another and returns the remainder.

Syntax

$x = y \text{ MOD } z$

Instructions

This MOD operator is only used in numeric expressions.

Example

```
Print 19 MOD 5 'prints: 4
```

6.7 NOT

General Information	
Type	Operator
Description	Performs a logical NOT operation on a boolean expression.

Syntax

result = not (boolean-expression)

Instructions

The result evaluates to True if, and only if, the boolean expressions is False. Otherwise, the result is False.

Example

```
Main
  if (1=1) then
    print "This will be printed"
  end if
  if NOT(1=1) then
    print "This will not be printed"
  end if
  if NOT(1=2) then
    print "This will also be printed"
  end if
End Main
```

6.8 OR

General Information	
Type	Operator
Description	Performs a logical OR operation on two expressions.

Syntax

result = a OR b

Instructions

The result evaluates to True if either of the expressions is True. Otherwise, the result is False.

Example

```
x = 17
y = 27
if (x > 20) OR (y > 20) then
    print "This will get printed"
end if
if (x < 20) OR (y > 20) then
    print "...so will this"
end if
```

6.9 SHL

General Information	
Type	Operator
Description	Left Shift Operator

Syntax

operand1 SHL operand2

Instructions

This operator performs a left shift by operand2 places of operand1. This is equivalent to multiplying operand1 by 2 operand2 number of times.

6.10 SHRA

General Information	
Type	Operator
Description	Arithmetic Right Shift Operator

Syntax

operand1 SHRA operand2

Instructions

This operator performs an arithmetic right shift of operand1 by operand2 number of places. This is equivalent to dividing operand1 by 2 operand2 number of times.

6.11 SHRL

General Information	
Type	Operator
Description	Logical Right Shift Operator

Syntax

operand1 SHRL operand2

Instructions

This operator performs a logical right shift of operand1 by operand2 number of places. In a logical right shift zeros are shifted in from the left.

6.12 XOR

General Information	
Type	Operator
Description	Performs a logical XOR operation on two expressions.

Syntax

result = a XOR b

Instructions

The result evaluates to True if, and only if, one of the boolean expressions is True and the other boolean expression is False.

Otherwise, the result is False.

Example

```
x = 17
y = 27
if (x > 20) XOR (y > 20) then
    print "This will get printed."
end if
if (x < 20) XOR (y > 20) then
    print "This won't get printed."
end if
```

7 AKD BASIC Parameters and Statements

This section is an alphabetical reference to AKD BASIC parameters. A list of additional statements which have no category are included at the start of this section.

7.1 Additional Statements

This section describes statements not directly related to a parameter set.

7.1.1 \$Include	119
7.1.2 Alias	120
7.1.3 Call	121
7.1.4 Cls	122
7.1.5 Const	123
7.1.6 Dim	124
7.1.7 Exit	125
7.1.8 For...Next	126
7.1.9 Function	127
7.1.10 GoTo	128
7.1.11 If...Then...Else	129
7.1.12 Input	130
7.1.13 On Error GoTo	131
7.1.14 Pause()	132
7.1.15 Print	133
7.1.16 Restart	134
7.1.17 Select Case	135
7.1.18 Static	136
7.1.19 Stop	137
7.1.20 Sub...End Sub	138
7.1.21 Swap	139
7.1.22 While...Wend	140

7.1.1 \$Include

General Information	
Type	Statement
Description	The \$Include statement allows you to textually include multiple separate files in a single source file.
Units	N/A
Range	N/A
Default Value	N/A
Data Type	N/A

Description

The \$Include statement allows you to textually include multiple separate files in a single source file. A file cannot include itself, either directly or indirectly. Include file nesting is allowed to a depth of 16. Relative paths in a nested include file are relative to the directory location of the include file, not the current working directory of the compiler.

Example

This example shows two file, myinc.inc and myfile.bas. The file myinc.inc has a sub-procedure for doing and incremental move that is used by the main program in myfile.bas.

MyInc.Inc:

```
Sub DoIndexMove( Distance as integer)
    MOVE.RELATIVEDIST = Distance
    MOVE.GOREL
    while MOVE.MOVING : wend
End Sub
```

MyFile.Bas"

```
$Include "myinc.inc"
Main
    while 1
        call DoIndexMove (4096)
        Pause (0.5)
    wend
End Main
```

7.1.2 Alias

General Information	
Type	Statement
Description	Allows you to define your own names for system resources, such as Input or Output pins.
Units	N/A
Range	N/A
Default Value	N/A
Data Type	N/A

Description

Allows you to define your own names for system resources, such as Input or Output pins. ALIAS is much more powerful than CONST. Constant expressions are computable at compile-time, whereas an alias has a value that may only be known at the time that it is being used. For this reason aliases should be used with care – over-use of aliases can make it very difficult to read a program.

Example

```
Alias CONVEYOR_IS_RUNNING = (DIN1.STATE = 0)
if CONVEYOR_IS_RUNNING then
    print "The conveyor is running"
end if
```

Related Topics

Const (pg 123)

7.1.3 Call

General Information	
Type	Statement
Description	Transfer program control to a subroutine. When the subroutine is finished then control is transferred to the line following the CALL.
Units	N/A
Range	N/A
Default Value	N/A
Data Type	N/A

Description

Transfer program control to a subroutine. When the subroutine is finished then control is transferred to the line following the CALL. A subroutine is essentially a function with no return value. Arguments to subroutines are passed "by value". This means that the subroutine receives a copy of these arguments. Any assignments to these arguments made by the subroutine will have no effect on these variables in the calling function or subroutine.

Example

```
Call PrintSum(3,4)
'----- Subroutines and Functions -----
Sub PrintSum(i,j,as integer)
    print i+j
End Sub
```

Related Topics

Sub...End Sub (pg 138)

7.1.4 Cls

General Information	
Type	Statement
Description	This statement transmits 40 line feed characters (ASCII code = 10) to the serial port. Cls clears the display of a terminal.
Units	N/A
Range	N/A
Default Value	N/A
Data Type	N/A

Description

This statement transmits 40 line feed characters (ASCII code = 10) to the serial port. Cls clears the display of a terminal.

Example

```
Print "Take a good look now..."  
pause (2)  
cls
```

Related Topics

[Statement Table\(1\)](#)

7.1.5 Const

General Information	
Type	Statement
Description	Declares symbolic constants to be used instead of numeric values.
Units	N/A
Range	N/A
Default Value	N/A
Data Type	N/A

Description

Declares symbolic constants to be used instead of numeric values. Using the CONST Statement can make your program much more readable and self-documenting.

Unlike variables, CONSTANTS can assume only one value in a program.

Example

```
Const SLEW_SPEED = 2500
Const WORK_SPEED = 100

MOVE.RUNSPEED = SLEW_SPEED : MOVE.GOVEL
Pause (0.5)
MOVE.RUNSPEED = WORK_SPEED : MOVE.GOVEL
```

Related Topics

Alias (pg 120)

7.1.6 Dim

General Information	
Type	Statement
Description	Used for declaring variables before use. All variables (except predefined variables) must be declared before they can be used.
Units	N/A
Range	N/A
Default Value	N/A
Data Type	N/A

Description

Used for declaring variables before use. All variables (except predefined variables) must be declared before they can be used. The DIM statement may also be used to specify that a global variable is non-volatile. When the controller is power-cycled non-volatile variables retain the value present when the controller was powered down. All other user variables are initialized to zero.

The default length for strings is 32 characters. This default can be overridden by following the STRING type designator with a * (see example).

There are 500 bytes available for user NV variables.

See the examples for how to use DIM to dimension an array.

Example

```
Dim x,y,z as Integer NV '3 non-volatile integers
Dim q as float '1 floating point
Dim Array1(4,5) as Integer 'a 4x5 array
Dim A$ as String*50 'a 50 character string
```

Related Topics

Static (pg 136)

7.1.7 Exit

General Information	
Type	Statement
Description	The Exit statement is used to exit from a subroutine, a function, an interrupt, a For...Next or a While...Wend.
Units	N/A
Range	N/A
Default Value	N/A
Data Type	N/A

Description

The Exit statement is used to exit from a subroutine, a function, an interrupt, a For...Next or a While...Wend. Do not confuse the Exit statement with the End statement. The Exit statement causes program control to pass to the end of the block structure whereas the End statement defines the end of the structure.

Related Topics

Sub...End Sub (pg 138) | Function (pg 127) | Interrupt...End Interrupt (pg 535) | For...Next (pg 126) | While...Wend (pg 140)

7.1.8 For...Next

General Information	
Type	Statement
Description	Allows a series of lines to be executed in a loop a specified number of times.
Units	N/A
Range	N/A
Default Value	N/A
Data Type	N/A

Description

Allows a series of lines to be executed in a loop a specified number of times. You can exit from a For...Next loop using the Exit statement. If Step increment is omitted then increment defaults to 1. The loop_counter can be floating point or integer. The Step increment can be positive or negative, integer or floating point.

Example

```
'print 2 to 100 in 2's
Dim x as integer
For x = 1 to 100 step 2
    print x
next

'print 0.5 to 1.2 in 0.1 increments
Dim x as float
For x = 0.5 to 1.2 step 0.1
    print x
next
```

Related Topics

While...Wend (pg 140) | Exit (pg 125)

7.1.9 Function

General Information	
Type	Statement
Description	The Function statement is used to declare and define the name, arguments and type of a user defined function.
Units	N/A
Range	N/A
Default Value	N/A
Data Type	N/A

Description

The Function statement is used to declare and define the name, arguments and type of a user defined function. The code for the function immediately follows the function statement and must be terminated by an End Function statement.

On entry to the function all local variables are initialized to zero including all elements of local arrays. All local string variables are initialized to the null string ("").

If a function takes no arguments then the argument-list (including the parentheses) must be omitted, both when declaring the function and when using the function.

The return value for the function is specified by making an assignment to the function name. See the example (cube) below.

Arguments, including array arguments, are passed by value. Arrays cannot be returned from functions.

Example

This example declares a function that calculates the cube of a floating point number.

```

Main
    dim LocalFloat as float
    LocalFloat = 1.234
    LocalFloat = cube(LocalFloat)
    print LocalFloat
End Main

Function cube( x as float) as float
    cube = x ^3
End Function

```

Related Topics

Dim (pg 124) | Static (pg 136) | Exit (pg 125) | Sub...End Sub (pg 138)

7.1.10 GoTo

General Information	
Type	Statement
Description	GOTO causes the software to jump to the specified label and continue executing from there.
Units	N/A
Range	N/A
Default Value	N/A
Data Type	N/A

Description

GoTo causes the software to jump to the specified label and continue executing from there. GoTo is not recommended as a looping technique. Excessive use of the GoTo statement can lead to disorganized and confusing programs. Preferred looping techniques are:

- For...Next
- If...Then...Else
- While...Wend

Related Topics

On Error GoTo (pg 131)

7.1.11 If...Then...Else

General Information	
Type	Statement
Description	If...Then...Else statements controls program execution based on the evaluation of numeric or string expressions.
Units	N/A
Range	N/A
Default Value	N/A
Data Type	N/A

Description

If...Then...Else statements controls program execution based on the evaluation of numeric or string expressions. The syntax of If...Then...Else statements are as follows:

```

IF condition1 THEN
    ...statement block1...
[ ElseIf condition2 Then
    ...statement block2...]
[Else
    ...statement block3...]
End If

```

If condition1 is True then statement block1 is executed. Otherwise, if condition2 is True then statement block2 is executed. If the original IF condition is False and all ELSEIF conditions are False then the ELSE statement block (statement block3) is executed.

Related Topics

Select Case (pg 135) | While...Wend (pg 140) | Exit (pg 125)

7.1.12 Input

General Information	
Type	Statement
Description	The Input statement reads a character string received from the console tab screen below the program editor window, terminated by a carriage-return.
Units	N/A
Range	N/A
Default Value	N/A
Data Type	N/A

Description

The Input statement reads a character string received from the console tab screen below the program editor window, terminated by a carriage-return. The input variable can be integer, floating-point or a string. As an option, the prompt-string is transmitted when the Input statement is encountered. This prompt-string can be either a string constant or a string variable. If the prompt-string is followed by a semi-colon, then a question mark will be printed at the end of the prompt-string. If the prompt-string is followed by a comma then no question mark will be printed.

Example

```
Main
  dim YourName$ as string
  input "What's your name"; YourName$
  print "Hello ";YourName$;", I'm leaving..."
End Main
```

Related Topics

[Statement Table\(1\)](#)

7.1.13 On Error GoTo

General Information	
Type	Statement
Description	On Error Goto allows you to define a run-time error handler to prevent run-time errors from halting program execution.
Units	N/A
Range	N/A
Default Value	N/A
Data Type	N/A

Description

On Error Goto allows you to define a run-time error handler to prevent run-time errors from halting program execution. Different error handlers can be defined for different parts of the program. An error handler is active from when the On Error Goto statement is executed until another one is executed.

An error handler has the same structure as a subroutine, but must end with a Restart statement. If the error handler does not end with a Restart statement then program execution will terminate at the End Sub statement.

Using the form On Error Goto 0 disables any user defined run-time error handler and reinstalls the default handler. Any subsequent run-time error will print an error message and halt the program.

Errors occurring within the error handler are handled by the default error handler. This means that they will halt program execution.

Example

```

dim Count as integer
Main
    dim y as integer
    if Count < 10 then
        on error goto MyHandler
    else
        on error goto 0
    end if
    y = 0
    pause (0.5)
    y = 1/y
    print "I'll never get here"
end main

Sub MyHandler
    Count = Count+1
    print Count
    restart
End Sub

```

Related Topics

Restart (pg 134)

7.1.14 Pause()

General Information	
Type	Statement
Description	Causes the program execution to pause for a specified amount of time. The motion of the motor is not affected.
Units	seconds
Range	N/A
Default Value	N/A
Data Type	N/A

Description

Causes the program execution to pause for a specified amount of time. The motion of the motor is not affected. Interrupts are active during a Pause() statement.

Example

```
dim x as float

for x = 0.1 to 2.0 step 0.1
  DOUT1.STATEU = 1
  Pause (x)
  DOUT1.STATEU = 0
  Pause (x)
next
```

Related Topics

[Statement Table\(1\)](#)

7.1.15 Print

General Information	
Type	Statement
Description	Displays formatted output through the console while the program is running.
Units	N/A
Range	N/A
Default Value	N/A
Data Type	N/A

Description

AKD BASIC defines zones of 13 characters which can be used to produce output in columns.

If a list of expressions is separated by commas (,) then each subsequent expression is printed in the next zone.

If a list of expressions is separated by semi-colons (;) then the zones are ignored and consecutive expressions are printed in the next available character space.

If a PRINT statement ends in a comma or semi-colon then carriage-return/line-feed at the end of serial output is suppressed.

Example

```
Print "Hello" , "Goodbye"
Print "Hello" ; "Goodbye"
Print "Hello" , "Goodbye";
Print "...The End."
```

Related Topics

[Statement Table\(1\)](#)

7.1.16 Restart

General Information	
Type	Statement
Description	Causes program execution to begin again from the beginning of the program.
Units	N/A
Range	N/A
Default Value	N/A
Data Type	N/A

Description

Causes program execution to begin again from the beginning of the program. Restart is the only way to exit from an Error Handler routine. Any interrupts, WHEN statements or loops in progress will be aborted. If the RESTART statement is used to exit from a user error handler then an infinite loop will occur if the error condition is not cleared.

Note: RESTART does not clear the user program variables or by itself change any program variables, any predefined variables or have any effect on motor motion.

Related Topics

MOVE.ABORT (pg 590) | On Error GoTo (pg 131)

7.1.17 Select Case

General Information	
Type	Statement
Description	Select Case executes one of several statement blocks depending upon the value of an expression.
Units	N/A
Range	N/A
Default Value	N/A
Data Type	N/A

Description

Select Case executes one of several statement blocks depending upon the value of an expression. The test-expression must evaluate to a numeric or floating-point value. There may be as many Cases in the Select Case statement as you want. There can only be one Case Else and it must be the last case in the sequence. The Case Else statement block is executed if all other tests fail.

Select Case statements where the expression-lists are integer constants are executed more quickly at run-time.

Example

This example prints out information about the numbers between 1 and 20.

```

Main
  dim x as integer
  for x = 1 to 20
    print x;" is ";
    select case x
      case 1, 3, 5, 7, 9
        print "Odd"
      case 4, 8
        print "4 or 8"
      case 12 to 18
        print "between 12 and 18"
      case else
        print "other"
    end select
  next
End Main

```

Related Topics

If...Then...Else (pg 129)

7.1.18 Static

General Information	
Type	Statement
Description	The Static statement is used in a Function, Sub or Interrupt to specify that the specified variable's value be remembered even when the Function or Sub is finished.
Units	N/A
Range	N/A
Default Value	N/A
Data Type	N/A

Description

The Static statement is used in a Function, Sub or Interrupt to specify that the specified variable's value be remembered even when the Function or Sub is finished. The next time that the Function, Sub or Interrupt is executed, the value will be available.

Example

This example illustrates the difference between using Dim and Static in a Sub procedure. 'x' always gets reset to zero, while 'y' continually gets incremented.

```

Main
  while 1
    call MySub
    pause (1)
  wend
End Main

Sub MySub
  dim x as integer 'value is forgotten
  static y as integer 'value is remembered
  x = x + 1
  y = y + 1
  print x,y
End Sub

```

Related Topics

[Dim \(pg 124\)](#) | [Sub...End Sub \(pg 138\)](#) | [Function \(pg 127\)](#) | [Interrupt...End Interrupt \(pg 535\)](#)

7.1.19 Stop

General Information	
Type	Statement
Description	Stops execution of the user program.
Units	N/A
Range	N/A
Default Value	N/A
Data Type	N/A

Description

Stops execution of the user program. When the user program stops AKD BASIC goes back to message mode, waiting for a command over the communications link.

Related Topics

MOVE.ABORT (pg 590)

7.1.20 Sub...End Sub

General Information	
Type	Statement
Description	The Sub statement declares a sub procedure and defines the sub procedures format.
Units	N/A
Range	N/A
Default Value	N/A
Data Type	N/A

Description

The Sub statement declares a sub procedure and defines the sub procedures format. A sub procedure is invoked with the Call statement. A sub-procedure can accept arguments like a function, but does not return any value. If the sub-procedure does not take any arguments then it is illegal to provide an empty argument-list "()" either when defining the sub-procedure or when calling it.

Example

This example defines a sub-procedure that takes one integer argument.

```

Main
    dim x as integer
    for x = 1 to 10
        call MySub (x)
        pause (1)
    next
End Main

Sub MySub (a as integer)
    print a; "----> ";
    if a <= 5 then
        print a * 0.5
    else
        print a * 2.0
    end if
End Sub

```

Related Topics

Call (pg 121) | Function (pg 127) | Exit (pg 125)

7.1.21 Swap

General Information	
Type	Statement
Description	Exchanges the value of two variables.
Units	N/A
Range	N/A
Default Value	N/A
Data Type	N/A

Description

Exchanges the value of two variables. The two variables must be both numeric (floating point or integer) or both strings.

Example

```
Main
  dim A$, B$ as string
  A$ = "Hello"
  B$ = "Good-bye"
  print A$, B$
  Swap A$, B$
  print A$, B$
End Main
```

Related Topics

[Statement Table\(1\)](#)

7.1.22 While...Wend

General Information	
Type	Statement
Description	Executes a series of lines for as long as the condition after the WHILE is True.
Units	N/A
Range	N/A
Default Value	N/A
Data Type	N/A

Description

Executes a series of lines for as long as the condition after the WHILE is True. While...wend statements may be nested. Each Wend is matched to the most recent While. Unmatched While or Wend statements cause compile time errors.

Example

```

DRV.TIME = 0
While DRV.TIME < 5
    MOVE.DIR = DIN1.STATE : MOVE.GOVEL
Wend
MOVE.ABORT

```

Related Topics

[Exit \(pg 125\)](#) | [For...Next \(pg 126\)](#)

7.2 AIN Parameters

This section describes the analog input (AIN) parameters. AIN parameters function as shown in the block diagram below:

7.2.1 AIN.CUTOFF	142
7.2.2 AIN.DEADBAND	143
7.2.3 AIN.DEADBANDMODE	145
7.2.4 AIN.ISCALE	147
7.2.5 AIN.MODE	148
7.2.6 AIN.OFFSET	150
7.2.7 AIN.PSCALE	151
7.2.8 AIN.VALUE	153
7.2.9 AIN.VSCALE	154
7.2.10 AIN.ZERO	156

7.2.1 AIN.CUTOFF

General Information	
Type	NV Parameter
Description	Sets the analog input low-pass filter cutoff frequency.
Units	Hz
Range	0 to 10,000 Hz
Default Value	5,000 Hz
Data Type	Float
Start Version	M_01-00-00-000

Variants Supported

Variant	Supported
AKD Base	Yes
AKD with Position Indexer	Yes
AKD EtherCAT	Yes
AKD CANopen	Yes
AKD BASIC	Yes
AKD SynqNet	Yes
AKD EtherNet/IP	Yes
AKD Profinet	Yes
AKD sercos [®] III	Yes
AKD-N	No
AKD-C	No

Fieldbus Information

Fieldbus	Address	Attributes	Signed?
Profinet	2000	DWord	No
sercos [®] III		4 Octets	

Fieldbus	Index/Subindex	Is 64 bit?	Attributes	Signed?	Object Start Version
Modbus	0	No	32 bit	No	M_01-03-00-000

Description

AIN.CUTOFF sets the break frequency in Hz for two cascaded single-pole low-pass filters on the hardware command input. Since the two poles are cascaded at the same frequency, the -3 dB frequency is $0.64 \cdot \text{AIN.CUTOFF}$ in hertz and the 10% to 90% step response rise time is $0.53/\text{AIN.CUTOFF}$ in seconds.

Suggested operating values are as follows:

- Analog torque opmode: 5 kHz
- Analog velocity opmode: 2.5 kHz
- General purpose analog input high resolution: 500 Hz

7.2.2 AIN.DEADBAND

General Information	
Type	NV Parameter
Description	Sets the analog input signal dead-band.
Units	V
Range	0 to 12.5 V
Default Value	0 V
Data Type	Float
Start Version	M_01-00-00-000

Variant Support

Variant	Supported
AKD Base	Yes
AKD with Position Indexer	Yes
AKD EtherCAT	Yes
AKD CANopen	Yes
AKD BASIC	Yes
AKD SynqNet	Yes
AKD EtherNet/IP	Yes
AKD Profinet	Yes
AKD sercos [®] III	Yes
AKD-N	No
AKD-C	No

Fieldbus Information

Fieldbus	Address	Attributes	Signed?
Profinet	2001	Word	No
sercos [®] III		2 Octets	

Fieldbus	Index/Subindex	Is 64 bit?	Attributes	Signed?	Object Start Version
Modbus	2	No	16 bit	No	M_01-03-00-000

Description

AIN.DEADBAND sets the deadband of the analog input signal. When AIN.DEADBANDMODE is set to 0, and the value of the analog input is less than the value of AIN.DEADBAND, the analog command will be 0. When the analog input is greater or equal to the AIN.DEADBAND, then the analog command will be generated using the scaling specified.

When AIN.DEADBANDMODE is set to 1, the analog command is 0 if the input is less than the deadband value. When the input is greater than the deadband, the output is equal to (Input - Deadband) * Scaling. Below are illustrations of this behavior.

Ain.Deadbandmode= 0 | Ain.Deadband= 1V

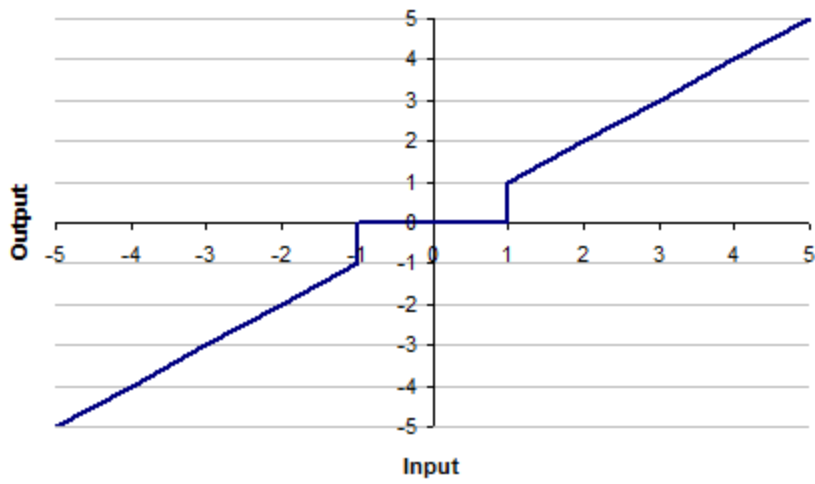

Ain.Deadbandmode= 1 | Ain.Deadband= 1V

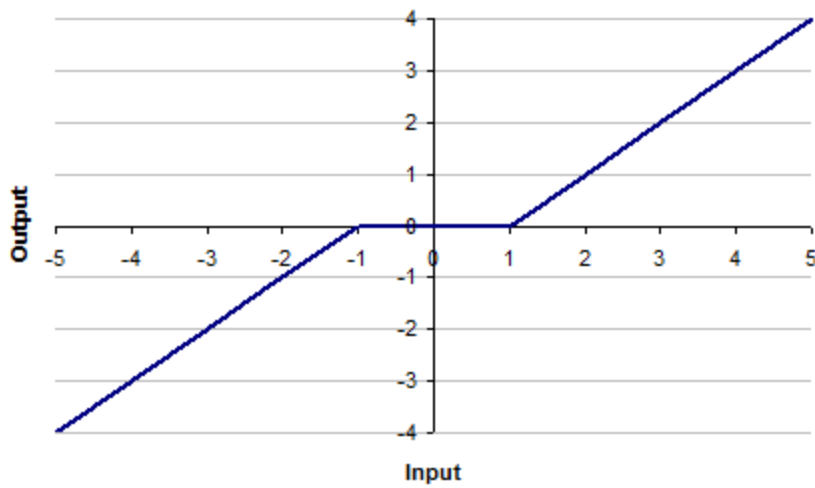

7.2.3 AIN.DEADBANDMODE

General Information	
Type	NV Parameter
Description	Sets the analog input deadband mode.
Units	N/A
Range	0 to 1
Default Value	0
Data Type	Integer
See Also	AIN.DEADBAND (pg 143)
Start Version	M_01-03-06-000

Variants Supported

Variant	Supported
AKD Base	Yes
AKD with Position Indexer	Yes
AKD EtherCAT	Yes
AKD CANopen	Yes
AKD BASIC	Yes
AKD SynqNet	Yes
AKD EtherNet/IP	Yes
AKD Profinet	Yes
AKD sercos [®] III	Yes
AKD-N	No
AKD-C	No

Fieldbus Information

Fieldbus	Address	Attributes	Signed?
Profinet	2593	Word	No
sercos [®] III		2 Octets	

Fieldbus	Index/Subindex	Is 64 bit?	Attributes	Signed?
Modbus	1186	No	16 bit	No

Description

When AIN.DEADBANDMODE is set to 0, and the value of the analog input is less than the value of AIN.DEADBAND, the analog command will be 0. When the analog input is greater or equal to the AIN.DEADBAND, then the analog command will be generated using the scaling specified.

When AIN.DEADBANDMODE is set to 1, the analog command is 0 if the input is less than the deadband value. When the input is greater than the deadband, the output is equal to (Input - Deadband) * Scaling. Below are illustrations of this behavior.

Ain.Deadbandmode= 0 | Ain.Deadband= 1V

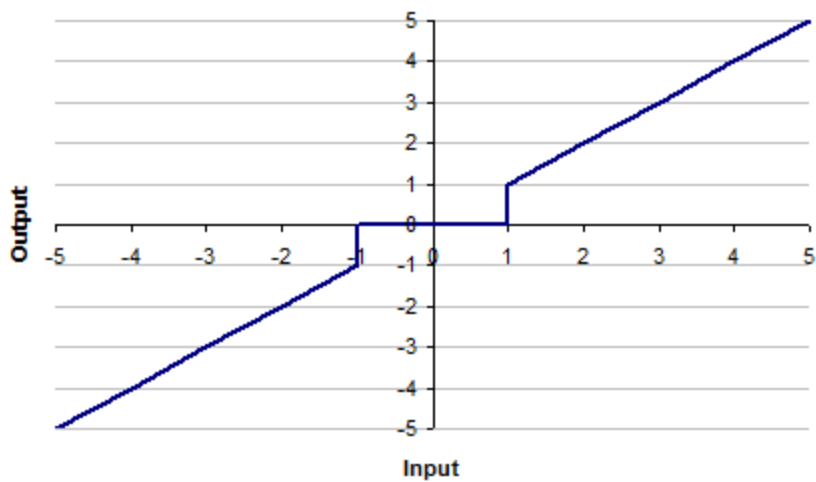

Ain.Deadbandmode= 1 | Ain.Deadband= 1V

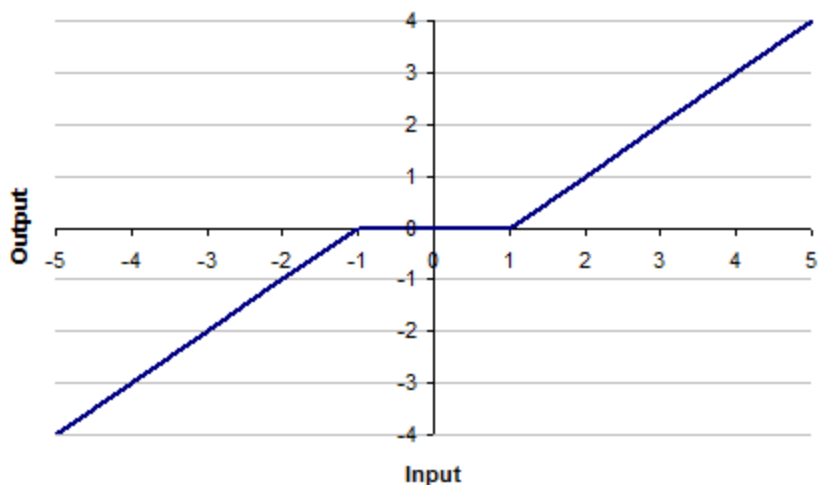

7.2.4 AIN.ISCALE

General Information	
Type	NV Parameter
Description	Sets the analog current scale factor.
Units	A/V
Range	0.001 to 22.4 A/V
Default Value	0.001 A/V
Data Type	Float
Start Version	M_01-01-01-000

Variants Supported

Variant	Supported
AKD Base	Yes
AKD with Position Indexer	Yes
AKD EtherCAT	Yes
AKD CANopen	Yes
AKD BASIC	Yes
AKD SynqNet	Yes
AKD EtherNet/IP	Yes
AKD Profinet	Yes
AKD sercos [®] III	Yes
AKD-N	No
AKD-C	No

Fieldbus Information

Fieldbus	Address	Attributes	Signed?
Profinet	2002	DWord	No
sercos [®] III		4 Octets	

Fieldbus	Index/Subindex	Is 64 bit?	Attributes	Signed?	Object Start Version
Modbus	4	No	32 bit	No	M_01-03-00-000

Description

AIN.ISCALE sets the analog current scale factor that scales the analog input (AIN.VALUE) for DRV.OPMODE (pg 370) = 1 (analog torque mode).

The value entered is the motor current per 10 V of analog input. This value may be either higher or lower than 100%, but the actual analog input will be limited by the application current limit (IL.LIMITN (pg 508) and IL.LIMITP (pg 509)).

7.2.5 AIN.MODE

General Information	
Type	NV Parameter
Description	Analog input mode
Units	N/A
Range	0 to 2
Default Value	1
Data Type	Integer
Start Version	M_01-04-09-000

AKD SynqNet Information	
Range	0

AKD BASIC Information	
Range	0 to 1

Variants Supported

Variant	Supported
AKD Base	Yes
AKD with Position Indexer	Yes
AKD EtherCAT	Yes
AKD CANopen	Yes
AKD BASIC	Yes
AKD SynqNet	Yes
AKD EtherNet/IP	Yes
AKD Profinet	Yes
AKD sercos [®] III	Yes
AKD-N	No
AKD-C	No

Fieldbus Information

Fieldbus	Address	Attributes	Signed?
Profinet	2594	Byte	No
sercos [®] III		2 Octets	

Fieldbus	Index/Subindex	Is 64 bit?	Attributes	Signed?
Modbus	1188	No	8 bit	No

Description

The parameter AIN.MODE is used to assign a functionality to the voltage measured on the analog input pin.

0 – The analog input value is not used by any function.

1 – This mode only works when DRV.CMDSOURCE is set to 3 (analog). The measured voltage will be scaled with:

- AIN.ISCALE if DRV.OPMODE has been set to 0 (torque mode)
- AIN.VSCALE if DRV.OPMODE has been set to 1 (velocity mode)
- AIN.PSCALE if DRV.OPMODE has been set to 2 (position mode)

Afterwards, the value will be forwarded as a command value to the control-loops.

2 – This mode is used for generating a target velocity of a motion task. This mode works when DRV.OPMODE is set to 2 (position) and DRV.CMDSOURCE is set to 0 (service). The measured voltage will be scaled with AIN.VSCALE.

7.2.6 AIN.OFFSET

General Information	
Type	NV Parameter
Description	Sets the analog input offset.
Units	V
Range	-10 to +10 V
Default Value	0 V
Data Type	Float
Start Version	M_01-00-00-000

Variants Supported

Variant	Supported
AKD Base	Yes
AKD with Position Indexer	Yes
AKD EtherCAT	Yes
AKD CANopen	Yes
AKD BASIC	Yes
AKD SynqNet	Yes
AKD EtherNet/IP	Yes
AKD Profinet	Yes
AKD sercos [®] III	Yes
AKD-N	No
AKD-C	No

Fieldbus Information

Fieldbus	Address	Attributes	Signed?
Profinet	2003	Word	Yes
sercos [®] III		2 Octets	

Fieldbus	Index/Subindex	Is 64 bit?	Attributes	Signed?	Object Start Version
Modbus	6	No	16 bit	Yes	M_01-03-00-000

Description

AIN.OFFSET sets the analog offset, which is added to the analog input command to the drive. This value compensates for the analog input signal (AIN.VALUE (pg 153)) offset or drift.

7.2.7 AIN.PSCALE

General Information	
Type	NV Parameter
Description	Sets the analog position scale factor.
Units	Depends on UNIT.PROTARY (pg 718) or UNIT.PLINEAR (pg 716) Rotary: counts/V, rad/V, deg/V, Custom Units/V16-bit counts/V Linear: counts/V, mm/V, $\mu\text{m}/\text{V}$, Custom Units/V16-bit counts/V
Range	Rotary: 1 to 9,223,372,036,854,775 counts/V 0 to 13,493,026.816 rad/V 0.06 to 179.0 deg/V 0 to 10,737,418.240 (PIN/POUT)/V 0 to 140,737,488,355.327 16-bit counts/V Linear: 1 to 9,223,372,036,854,775 counts/V 0 to 2,147,483.648 mm/V 0 to 2,147,483,648.000 $\mu\text{m}/\text{V}$ 0 to 10,737,418.240 (PIN/POUT)/V 0 to 140,737,488,355.327 16-bit counts/V
Default Value	Rotary: 1 counts/V 0 rad/V 0 deg/V 0 (PIN/POUT)/V 0 16-bit counts/V Linear: 1 count/V 0 rad/V 0 deg/V 0 (PIN/POUT)/V 0 16-bit counts/V
Data Type	Float
Start Version	M_01-01-01-000

Variants Supported

Variant	Supported
AKD Base	Yes
AKD with Position Indexer	Yes
AKD EtherCAT	Yes
AKD CANopen	Yes
AKD BASIC	Yes
AKD SynqNet	Yes
AKD EtherNet/IP	Yes
AKD Profinet	Yes

Variant	Supported
AKD sercos [®] III	Yes
AKD-N	No
AKD-C	No

Fieldbus Information

Fieldbus	Index/Subindex	Object Start Version
EtherCAT COE and CANopen CANopen	3472h/0	M_01-00-00-000

Fieldbus	Address	Attributes	Signed?
Profinet	2004	DWord	Yes
sercos [®] III		8 Octets	

Fieldbus	Index/Subindex	Is 64 bit?	Attributes	Signed?	Object Start Version
Modbus	8	Yes	64 bit	Yes	M_01-03-00-000

Description

AIN.PSCALE is an analog position scale factor that scales the analog input (AIN.VALUE (pg 153)) for DRV.OPMODE (pg 370) = 2 , DRV.CMDSOURCE (pg 312) = 3 (analog position mode).

7.2.8 AIN.VALUE

General Information	
Type	R/O Parameter
Description	Reads the value of the analog input signal.
Units	V
Range	-12.5 to +12.5 V
Default Value	N/A
Data Type	Float
Start Version	M_01-00-00-000

Variants Supported

Variant	Supported
AKD Base	Yes
AKD with Position Indexer	Yes
AKD EtherCAT	Yes
AKD CANopen	Yes
AKD BASIC	Yes
AKD SynqNet	Yes
AKD EtherNet/IP	Yes
AKD Profinet	Yes
AKD sercos [®] III	Yes
AKD-N	No
AKD-C	No

Fieldbus Information

Fieldbus	Index/Subindex	Object Start Version
EtherCAT COE and CANopen CANopen	3470h/4 3509h/0	M_01-00-00-000

Fieldbus	Address	Attributes	Signed?
Profinet sercos [®] III	2006	Word 2 Octets	No

Fieldbus	Index/Subindex	Is 64 bit?	Attributes	Signed?	Object Start Version
Modbus	12	No	16 bit	No	M_01-03-00-000

Description

AIN.VALUE reads the analog input value after the value is filtered (as shown in the Analog Input Block Diagram).

Related Topics

AIN.ZERO (pg 156)

AIN.OFFSET (pg 150)

7.2.9 AIN.VSCALE

General Information	
Type	NV Parameter
Description	Sets analog velocity scale factor.
Units	Depends on UNIT.VROTARY (pg 720) or UNIT.ACCLINEAR (pg 712) Rotary: rpm/V, rps/V, (deg/s)/V, Custom Units/V, (rad/s)/V Linear: counts/s/V, (mm/s)/V, (µm/s)/V, Custom Units/V,
Range	Rotary: 0.060 to 60,000 rpm/V 0.001 to 1,000 rps/V 0.359 to 360,000 (deg/s)/V 0.005 to 5,000 [(Custom Units)/s]/V 0.006 to 6,283.186 (rad/s)/V Linear: 0.001 to 1.000 counts/s/V 0.001*MOTOR.PITCH (pg 570) to 1,000.000*MOTOR.PITCH (pg 570) (mm/s)/V 0.998*MOTOR.PITCH (pg 570) to 1,000,000.000*MOTOR.PITCH (pg 570) (µm/s)/V 0.005 to 5,000 [(Custom Units)/s]/V
Default Value	Rotary: 0.060 rpm/V 0.001 rps/V 0.359 (deg/s)/V 0.005 [(Custom Units)/s]/V 0.006 (rad/s)/V Linear: 0.001 counts/s/V 0.001*MOTOR.PITCH (pg 570) (mm/s)/V 0.998*MOTOR.PITCH (pg 570) (µm/s)/V 0.005 to 5,000 [(Custom Units)/s]/V
Data Type	Float
Start Version	M_01-02-00-000

Variants Supported

Variant	Supported
AKD Base	Yes
AKD with Position Indexer	Yes
AKD EtherCAT	Yes
AKD CANopen	Yes
AKD BASIC	Yes
AKD SynqNet	Yes
AKD EtherNet/IP	Yes
AKD Profinet	Yes
AKD sercos [®] III	Yes
AKD-N	No
AKD-C	No

Fieldbus Information

Fieldbus	Index/Subindex	Object Start Version
EtherCAT COE and CANopen CANopen	3629h/0	M_01-00-00-000

Fieldbus	Parameter	Address	Attributes	Signed?
Profinet	AIN.VSCALE_32	2007	DWord	No
sercos [®] III			8 Octets	

Fieldbus	Index/Subindex	Is 64 bit?	Attributes	Signed?	Object Start Version
Modbus	14	No	32 bit	No	M_01-03-00-000

Description

AIN.VSCALE is an analog velocity scale factor that scales the analog input AIN.VALUE (pg 153)) for DRV.OPMODE (pg 370) = 1 (analog velocity mode).

The value entered is the motor velocity per 1 V of analog input. This value may be either higher or lower than the application velocity limit (VL.LIMITP (pg 762) or VL.LIMITN (pg 760)), but the actual analog I/O will be limited by VL.LIMITP (pg 762) or VL.LIMITN (pg 760).

7.2.10 AIN.ZERO

General Information	
Type	Command
Description	Zeroes the analog input signal.
Units	N/A
Range	N/A
Default Value	N/A
Data Type	N/A
See Also	AIN.VALUE (pg 153), AIN.OFFSET (pg 150)
Start Version	M_01-00-00-000

Variants Supported

Variant	Supported
AKD Base	Yes
AKD with Position Indexer	Yes
AKD EtherCAT	Yes
AKD CANopen	Yes
AKD BASIC	Yes
AKD SynqNet	Yes
AKD EtherNet/IP	Yes
AKD Profinet	Yes
AKD sercos [®] III	Yes
AKD-N	No
AKD-C	No

Fieldbus Information

Fieldbus	Index/Subindex	Object Start Version
EtherCAT COE and CANopen CANopen	N/A	M_01-00-00-000

Fieldbus	Address	Attributes	Signed?
Profinet sercos [®] III	2008	Command	No

Fieldbus	Index/Subindex	Is 64 bit?	Attributes	Signed?	Object Start Version
Modbus	16	No	Command	No	M_01-03-00-000

Description

AIN.ZERO causes the drive to zero the analog input signal (AIN.VALUE (pg 153)). You may need to execute this command more than once to achieve zero offset, and AIN.OFFSET is modified in this process.

Related Topics

AIN.VALUE (pg 153)

AIN.OFFSET (pg 150)

7.3 AIN2 Parameters

This section describes the analog input 2 (AIN2) parameters.

7.3.1 AIN2.CUTOFF	158
7.3.2 AIN2.DEADBAND	159
7.3.3 AIN2.DEADBANDMODE	160
7.3.4 AIN2.MODE	161
7.3.5 AIN2.OFFSET	162
7.3.6 AIN2.VALUE	163
7.3.7 AIN2.ZERO	164

7.3.1 AIN2.CUTOFF

General Information	
Type	NV Parameter
Description	Sets the analog input 2 low-pass filter cutoff frequency.
Units	Hz
Range	0 to 10,000 Hz
Default Value	5,000 Hz
Data Type	Float
Start Version	M_01-06-03-000

Variants Supported

Supported by any AKD with extended IO.

Fieldbus Information

Fieldbus	Index/Subindex	Is 64 bit?	Attributes	Signed?	Object Start Version
Modbus	1234	No	32 bit	No	M_01-06-03-000

Description

AIN2.CUTOFF sets the break frequency in Hz for two cascaded single-pole low-pass filters on the hardware command input. Since the two poles are cascaded at the same frequency, the -3 dB frequency is $0.64 \cdot \text{AIN2.CUTOFF}$ in hertz and the 10% to 90% step response rise time is $0.53/\text{AIN2.CUTOFF}$ in seconds.

Suggested operating values are as follows:

- Analog torque opmode: 5 kHz
- Analog velocity opmode: 2.5 kHz
- General purpose analog input high resolution: 500 Hz

7.3.2 AIN2.DEADBAND

General Information	
Type	NV Parameter
Description	Sets the analog input 2 signal dead-band.
Units	V
Range	0 to 12.5 V
Default Value	0 V
Data Type	Float
Start Version	M_01-06-03-000

Variant Support

Supported by any AKD with extended IO.

Fieldbus Information

Fieldbus	Index/Subindex	Is 64 bit?	Attributes	Signed?	Object Start Version
Modbus	1236	No	16 bit	No	M_01-06-03-000

Description

AIN2.DEADBAND sets the deadband of the analog input 2 signal. When AIN2.DEADBANDMODE (pg 160) is set to 0, and the value of the analog input 2 is less than the value of AIN2.DEADBAND, the analog command will be 0. When the analog input 2 is greater or equal to the AIN2.DEADBAND, then the analog command will be generated using the scaling specified.

When AIN2.DEADBANDMODE is set to 1, the analog command is 0 if the input is less than the dead-band value. When the input is greater than the deadband, the output is equal to (Input - Deadband) * Scaling.

7.3.3 AIN2.DEADBANDMODE

General Information	
Type	NV Parameter
Description	Sets the analog input 2 deadband mode.
Units	N/A
Range	0 to 1
Default Value	0
Data Type	Integer
Start Version	M_01-06-03-000

Variants Supported

Supported by any AKD with extended IO.

Fieldbus Information

Fieldbus	Index/Subindex	Is 64 bit?	Attributes	Signed?
Modbus	1238	No	16 bit	No

Description

When AIN2.DEADBANDMODE is set to 0, and the value of the analog input 2 is less than the value of AIN2.DEADBAND (pg 159), the analog command will be 0. When the analog input 2 is greater or equal to the AIN2.DEADBAND, then the analog command will be generated using the scaling specified.

When AIN2.DEADBANDMODE is set to 1, the analog command is 0 if the input is less than the deadband value. When the input is greater than the deadband, the output is equal to (Input - Deadband) * Scaling.

Related Topics

AIN2.DEADBAND (pg 159)

7.3.4 AIN2.MODE

General Information	
Type	NV Parameter
Description	Analog input 2 mode
Units	N/A
Range	0
Default Value	0
Data Type	Integer
Start Version	M_01-06-03-000

AKD BASIC Information	
Range	0 to 1

Variants Supported

Supported by any AKD with extended IO.

Fieldbus Information

Fieldbus	Index/Subindex	Is 64 bit?	Attributes	Signed?
Modbus	1242	No	8 bit	No

Description

The parameter AIN2.MODE is used to assign a functionality to the voltage measured on the analog input 2 pin.

0 – The analog input value is not used by any function.

7.3.5 AIN2.OFFSET

General Information	
Type	NV Parameter
Description	Sets the analog input 2 offset.
Units	V
Range	-10 to +10 V
Default Value	0 V
Data Type	Float
Start Version	M_01-06-03-000

Variants Supported

Supported by any AKD with extended IO.

Fieldbus Information

Fieldbus	Index/Subindex	Is 64 bit?	Attributes	Signed?	Object Start Version
Modbus	1244	No	16 bit	Yes	M_01-06-03-000

Description

AIN2.OFFSET sets the analog offset, which is added to the analog input 2 command to the drive. This value compensates for the analog input 2 signal (AIN.VALUE (pg 153)) offset or drift.

Related Topics

AIN2.ZERO (pg 164)

7.3.6 AIN2.VALUE

General Information	
Type	R/O Parameter
Description	Reads the value of the analog input 2 signal.
Units	V
Range	-12.5 to +12.5 V
Default Value	N/A
Data Type	Float
Start Version	M_01-06-03-000

Variants Supported

Supported by any AKD with extended IO.

Fieldbus Information

Fieldbus	Index/Subindex	Object Start Version
EtherCAT COE and CANopen	3470h/4	M_01-00-00-000
	3509h/0	

Fieldbus	Index/Subindex	Is 64 bit?	Attributes	Signed?	Object Start Version
Modbus	1250	No	16 bit	No	M_01-06-03-000

Description

AIN2.VALUE reads the analog input 2 value after the value is filtered (as shown in the Analog Input Block Diagram).

Related Topics

AIN2.OFFSET (pg 162)

AIN2.ZERO (pg 164)

7.3.7 AIN2.ZERO

General Information	
Type	Command
Description	Zeroes the analog input 2 signal.
Units	N/A
Range	N/A
Default Value	N/A
Data Type	N/A
Start Version	M_01-06-03-000

Variants Supported

Supported by any AKD with extended IO.

Fieldbus Information

Fieldbus	Index/Subindex	Object Start Version
EtherCAT COE and CANopen	N/A	M_01-00-00-000

Fieldbus	Index/Subindex	Is 64 bit?	Attributes	Signed?	Object Start Version
Modbus	1258	No	Command	No	M_01-06-03-000

Description

AIN2.ZERO causes the drive to zero the analog input 2 signal (AIN2.VALUE (pg 163)). You may need to execute this command more than once to achieve zero offset, and AIN2.OFFSET (pg 162) is modified in this process.

Related Topics

AIN2.VALUE (pg 163)

AIN2.OFFSET (pg 162)

7.4 AOUT Parameters

This section describes the AOUT parameters.

7.4.1 AOUT.CUTOFF	166
7.4.2 AOUT.DEBUGADDR	167
7.4.3 AOUT.DEBUGDATATYPE	168
7.4.4 AOUT.DEBUGSCALE	169
7.4.5 AOUT.ISCALE	170
7.4.6 AOUT.MODE	171
7.4.7 AOUT.OFFSET	173
7.4.8 AOUT.PSCALE	174
7.4.9 AOUT.VALUE	176
7.4.10 AOUT.VALUEU	177
7.4.11 AOUT.VSCALE	178

7.4.1 AOUT.CUTOFF

General Information	
Type	NV Parameter
Description	Sets the analog output low-pass filter cutoff frequency.
Units	Hz
Range	0 to 10,000 Hz
Default Value	0 Hz
Data Type	Float
Start Version	M_01-04-01

Variants Supported

Variant	Supported
AKD Base	Yes
AKD with Position Indexer	Yes
AKD EtherCAT	Yes
AKD CANopen	Yes
AKD BASIC	Yes
AKD SynqNet	Yes
AKD EtherNet/IP	Yes
AKD Profinet	Yes
AKD sercos [®] III	Yes
AKD-N	No
AKD-C	No

Fieldbus Information

Fieldbus	Address	Attributes	Signed?
Profinet	2635	DWord	No
sercos [®] III		4 Octets	

Fieldbus	Index/Subindex	Is 64 bit?	Attributes	Signed?	Object Start Version
Modbus	1270	No	32-bit	No	M_01-06-03-000

Description

AOUT.CUTOFF sets the cutoff frequency in Hz for a single-pole low-pass filter on the Analog Output.

A value of 0 Hz will turn off the filter and will allow all frequencies to pass through.

The filter can be used with all modes of Analog Output.

7.4.2 AOUT.DEBUGADDR

General Information	
Type	NV Parameter
Description	Sets the memory address to debug.
Units	N/A
Range	4 to 4,292,870,142
Default Value	4
Data Type	Integer
Start Version	M_01-01-01-000

Variants Supported

Variant	Supported
AKD Base	Yes
AKD with Position Indexer	Yes
AKD EtherCAT	Yes
AKD CANopen	Yes
AKD BASIC	Yes
AKD SynqNet	Yes
AKD EtherNet/IP	Yes
AKD Profinet	Yes
AKD sercos [®] III	Yes
AKD-N	No
AKD-C	No

Description

AOUT.DEBUGADDR sets the memory address to debug when AOUT.MODE (pg 171) = 9 (debug mode).

7.4.3 AOUT.DEBUGDATATYPE

General Information	
Type	NV Parameter
Description	Sets the data type of the value to be debugged.
Units	N/A
Range	0 to 10
Default Value	0
Data Type	Integer
Start Version	M_01-01-01-000

Variants Supported

Variant	Supported
AKD Base	Yes
AKD with Position Indexer	Yes
AKD EtherCAT	Yes
AKD CANopen	Yes
AKD BASIC	Yes
AKD SynqNet	Yes
AKD EtherNet/IP	Yes
AKD Profinet	Yes
AKD sercos [®] III	Yes
AKD-N	No
AKD-C	No

Fieldbus Information

Description

AOUT.DEBUGDATATYPE is used in AOUT.MODE (pg 171) = 9 (debug mode).

This parameter sets the data type of the value to be debugged according to the table below:

Value	Data Type
0	Illegal type
1	Signed (1 byte)
2	Unsigned (1 byte)
3	Signed (2 bytes)
4	Unsigned (2 bytes)
5	Signed (4 bytes)
6	Unsigned (4 bytes)
7	Signed (8 bytes)
8	Unsigned (8 bytes)
9	Pointer to one byte
10	Fix shift

7.4.4 AOUT.DEBUGSCALE

General Information	
Type	NV Parameter
Description	Sets the scale to be used for debug.
Units	N/A
Range	0.001 to 9,223,372,036,854,775.000
Default Value	1
Data Type	Float
Start Version	M_01-01-01-000

Variants Supported

Variant	Supported
AKD Base	Yes
AKD with Position Indexer	Yes
AKD EtherCAT	Yes
AKD CANopen	Yes
AKD BASIC	Yes
AKD SynqNet	Yes
AKD EtherNet/IP	Yes
AKD Profinet	Yes
AKD sercos [®] III	Yes
AKD-N	No
AKD-C	No

Description

AOUT.DEBUGSCALE sets the scale to be used for debug when AOUT.MODE (pg 171) = 9 (debug mode).

7.4.5 AOUT.ISCALE

General Information	
Type	NV Parameter
Description	Sets the analog current scale factor.
Units	A/V
Range	0.001 to 22.4 A/V
Default Value	0.001 to 22.4 A/V
Data Type	Float
Start Version	M_01-01-01-000

Variants Supported

Variant	Supported
AKD Base	Yes
AKD with Position Indexer	Yes
AKD EtherCAT	Yes
AKD CANopen	Yes
AKD BASIC	Yes
AKD SynqNet	Yes
AKD EtherNet/IP	Yes
AKD Profinet	Yes
AKD sercos [®] III	Yes
AKD-N	No
AKD-C	No

Fieldbus Information

Fieldbus	Address	Attributes	Signed?
Profinet	2009	DWord	No
sercos [®] III		4 Octets	

Fieldbus	Index/Subindex	Is 64 bit?	Attributes	Signed?	Object Start Version
Modbus	18	No	32 bit	No	M_01-03-00-000

Description

AOUT.ISCALE sets the analog current scale factor that scales the analog output (AOUT.VALUE) for AOUT.MODE = 4 or 5. The value entered is the motor current per 10 V of analog input or output. This value may be either higher or lower than 100%, but the actual analog I/O will be limited by the application current limit (IL.LIMITN (pg 508) and IL.LIMITP (pg 509)).

7.4.6 AOUT.MODE

General Information	
Type	NV Parameter
Description	Sets the analog output mode.
Units	N/A
Range	0 to 11
Default Value	0
Data Type	Integer
Start Version	M_01-00-00-000

SynqNet Information	
Range	12

Variants Supported

Variant	Supported
AKD Base	Yes
AKD with Position Indexer	Yes
AKD EtherCAT	Yes
AKD CANopen	Yes
AKD BASIC	Yes
AKD SynqNet	Yes
AKD EtherNet/IP	Yes
AKD Profinet	Yes
AKD sercos [®] III	Yes
AKD-N	No
AKD-C	No

Fieldbus Information

Fieldbus	Index/Subindex	Object Start Version
EtherCAT COE and CANopen CANopen	3470h/1	M_01-00-00-000

Fieldbus	Address	Attributes	Signed?
Profinet	2010	Word	No
sercos [®] III		2 Octets	

Fieldbus	Index/Subindex	Is 64 bit?	Attributes	Signed?	Object Start Version
Modbus	20	No	16 bit	No	M_01-03-00-000

Description

AOUT.MODE sets the analog output functionality.

AOUT.MODE	Description
0	User variable. The analog output signal is determined by the user (using AOUT.VALUEU).
1	Actual velocity. The analog signal describes the current velocity value (VL.FB).
2	Velocity error. The analog signal describes the velocity error value.
3	Velocity command. The analog signal describes the velocity command value.
4	Actual current. The analog signal describes the actual current value.
5	Current command. The analog signal describes the current command value.
6	Actual position. The analog signal describes the current position value.
7	Position error. The analog signal describes the position error value.
8	Triangle wave. The analog signal is a triangle wave (sawtooth pattern).
9	Debug mode. In this mode the user can define a drive variable to monitor via the analog output (AOUT.VALUEU).
10	Unfiltered Velocity (VL.FBUNFILTERED)
11	Filtered Velocity - 10Hz Lowpass (VL.FBFILTER)

Example

You can use AOUT.MODE and AOUT.VALUEU to configure an output signal as follows:

```
-->AOUT.MODE 0
-->AOUT.VALUEU 5
-->AOUT.VALUEU 4.33
```

7.4.7 AOUT.OFFSET

General Information	
Type	NV Parameter
Description	Sets the analog output offset.
Units	V
Range	-10 to +10 V
Default Value	0 V
Data Type	Float
Start Version	M_01-00-00-000

Variants Supported

Variant	Supported
AKD Base	Yes
AKD with Position Indexer	Yes
AKD EtherCAT	Yes
AKD CANopen	Yes
AKD BASIC	Yes
AKD SynqNet	Yes
AKD EtherNet/IP	Yes
AKD Profinet	Yes
AKD sercos [®] III	Yes
AKD-N	No
AKD-C	No

Fieldbus Information

Fieldbus	Address	Attributes	Signed?
Profinet	2011	Word	Yes
sercos [®] III		2 Octets	

Fieldbus	Index/Subindex	Is 64 bit?	Attributes	Signed?	Object Start Version
Modbus	22	No	16 bit	Yes	M_01-03-00-000

Description

This parameter sets the analog output offset.

7.4.8 AOUT.PSCALE

General Information	
Type	NV Parameter
Description	Sets the analog position scale factor.
Units	Depends on UNIT.PROTARY (pg 718) or UNIT.PLINEAR (pg 716) Rotary: counts/V, rad/V, deg/V, Custom Units/V, 16-bit counts/V Linear: counts/V, mm/V, $\mu\text{m/V}$, Custom Units/V, 16-bit counts/V
Range	Rotary: 1 to 9,223,372,036,854,775 counts/V 0 to 13,493,026.816 rad/V 0 to 773,094,113.280 deg/V 0 to 10,737,418.240 (Custom Units)/V 0 to 140,737,488,355.327 16-bit counts/V Linear: 1 to 9,223,372,036,854,775 counts/V 0 to 2,147,483.648 mm/V 0 to 2,147,483,648.000 $\mu\text{m/V}$ 0 to 10,737,418.240 (Custom Units)/V 0 to 140,737,488,355.327 16-bit counts/V
Default Value	Rotary: 1 counts/V 0 rad/V 0 deg/V 0 (Custom Units)/V 0 16-bit counts/V Linear: 1 counts/V 0 rad/V 0 deg/V 0 (Custom Units)/V 0 counts 16 bit/V
Data Type	Float
Start Version	M_01-01-01-000

Variants Supported

Variant	Supported
AKD Base	Yes
AKD with Position Indexer	Yes
AKD EtherCAT	Yes
AKD CANopen	Yes
AKD BASIC	Yes
AKD SynqNet	Yes
AKD EtherNet/IP	Yes
AKD Profinet	Yes

Variant	Supported
AKD sercos [®] III	Yes
AKD-N	No
AKD-C	No

Fieldbus Information

Fieldbus	Index/Subindex	Object Start Version
EtherCAT COE and CANopen CANopen	3471h/0	M_01-00-00-000

Fieldbus	Address	Attributes	Signed?
Profinet	2012	DWord	Yes
sercos [®] III		8 Octets	

Fieldbus	Index/Subindex	Is 64 bit?	Attributes	Signed?	Object Start Version
Modbus	24	Yes	64 bit	No	M_01-03-00-000

Description

AOUT.PSCALE is an analog position scale factor that scales the analog output (AOUT.VALUE (pg 176)) for AOUT.MODE (pg 171) = 6, or 7 (actual position or position error) per 10 V of analog input or output.

7.4.9 AOUT.VALUE

General Information	
Type	R/O Parameter
Description	Reads the analog output value.
Units	V
Range	-10 to +10 V
Default Value	0
Data Type	Float
Start Version	M_01-00-00-000

Variants Supported

Variant	Supported
AKD Base	Yes
AKD with Position Indexer	Yes
AKD EtherCAT	Yes
AKD CANopen	Yes
AKD BASIC	Yes
AKD SynqNet	Yes
AKD EtherNet/IP	Yes
AKD Profinet	Yes
AKD sercos [®] III	Yes
AKD-N	No
AKD-C	No

Fieldbus Information

Fieldbus	Index/Subindex	Object Start Version
EtherCAT COE and CANopen CANopen	3470h/2	M_01-00-00-000

Fieldbus	Address	Attributes	Signed?
Profinet	2014	DWord	Yes
sercos [®] III		8 Octets	

Fieldbus	Index/Subindex	Is 64 bit?	Attributes	Signed?	Object Start Version
Modbus	28	Yes	64 bit	Yes	M_01-03-00-000

Description

AOUT.VALUE reads the analog output value.

7.4.10 AOUT.VALUEU

General Information	
Type	R/W Parameter
Description	Sets the analog output value.
Units	V
Range	-10 to +10 V
Default Value	0
Data Type	Float
Start Version	M_01-00-00-000

Variants Supported

Variant	Supported
AKD Base	Yes
AKD with Position Indexer	Yes
AKD EtherCAT	Yes
AKD CANopen	Yes
AKD BASIC	Yes
AKD SynqNet	Yes
AKD EtherNet/IP	Yes
AKD Profinet	Yes
AKD sercos [®] III	Yes
AKD-N	No
AKD-C	No

Fieldbus Information

Fieldbus	Index/Subindex	Object Start Version
EtherCAT COE and CANopen CANopen	3470h/3	M_01-00-00-000

Fieldbus	Address	Attributes	Signed?
Profinet	2016	DWord	Yes
sercos [®] III		8 Octets	

Fieldbus	Index/Subindex	Is 64 bit?	Attributes	Signed?	Object Start Version
Modbus	32	Yes	64 bit	Yes	M_01-03-00-000

Description

AOUT.VALUEU reads/writes the analog output value when AOUT.MODE (pg 171) = 0 (analog output signal is determined by the user).

7.4.11 AOUT.VSCALE

General Information	
Type	NV Parameter
Description	Sets the velocity scale factor for analog output.
Units	Depends on UNIT.VROTARY or UNIT.ACCLINEAR Rotary: rpm/V, rps/V, (deg/s)/V, [(custom units)/s]/V, (rad/s)/V Linear: counts/s/V, (mm/s)/V, (µm/s)/V, [(custom units)/s]/V
Range	Rotary: 0.060 to 60,000 rpm/V 0.001 to 1,000 rps/V 0.359 to 360,000 (deg/s)/V 0.005 to 5,000 [(custom units)/s]/V 0.006 to 6,283.186 (rad/s)/V Linear: 0.001 to 1.000 counts/s/V 0.001*MOTOR.PITCH to 1,000.000*MOTOR.PITCH (mm/s)/V 0.998*MOTOR.PITCH to 1,000.000.000*MOTOR.PITCH(µm/s)/V 0.005 to 5,000 [(custom units)/s]/V
Default Value	Rotary: 0.060 rpm/V 0.001 rps/V 0.359 (deg/s)/V 0.005 [(custom units)/s]/V 0.006 (rad/s)/V Linear: 0.001 counts/s/V 0.001*MOTOR.PITCH (mm/s)/V 0.998*MOTOR.PITCH (µm/s)/V 0.005 [(custom units)/s]/V
Data Type	Float
Start Version	M_01-00-00-000

Variants Supported

Variant	Supported
AKD Base	Yes
AKD with Position Indexer	Yes
AKD EtherCAT	Yes
AKD CANopen	Yes
AKD BASIC	Yes
AKD SynqNet	Yes
AKD EtherNet/IP	Yes
AKD Profinet	Yes
AKD sercos [®] III	Yes
AKD-N	No
AKD-C	No

Fieldbus Information

Fieldbus	Index/Subindex	Object Start Version
EtherCAT COE and CANopen CANopen	3470h/5	M_01-00-00-000

Fieldbus	Parameter	Address	Attributes	Signed?
Profinet	AOUT.VSCALE_32	2018	DWord	No
sercos® III			8 Octets	
Profinet	AOUT.VSCALE	2858	DWord	
sercos® III			8 Octets	

Fieldbus	Index/Subindex	Is 64 bit?	Attributes	Signed?	Object Start Version
Modbus	36	No	32 bit	No	M_01-03-00-000

Description

AOUT.VSCALE is an analog velocity scale factor that scales the analog output (AOUT.VALUE) for AOUT.MODE = 1, 2, or 3. The value entered is the motor velocity per 10 V of analog output. This value may be either higher or lower than the application velocity limit (VL.LIMITP or VL.LIMITN), but the actual analog I/O will be limited by VL.LIMITP or VL.LIMITN.

7.5 AOUT2 Parameters

This section describes the AOUT2 parameters.

7.5.1 AOUT2.CUTOFF	181
7.5.2 AOUT2.MODE	182
7.5.3 AOUT2.OFFSET	183
7.5.4 AOUT2.VALUE	184
7.5.5 AOUT.VALUEU	185

7.5.1 AOUT2.CUTOFF

General Information	
Type	NV Parameter
Description	Sets the analog output 2 low-pass filter cutoff frequency.
Units	Hz
Range	0 to 10,000 Hz
Default Value	0 Hz
Data Type	Float
Start Version	M_01-06-03-000

Variants Supported

Supported by any AKD with extended IO.

Fieldbus Information

Fieldbus	Index/Subindex	Is 64 bit?	Attributes	Signed?	Object Start Version
Modbus	1272	Yes	32-bit	No	M_01-06-03-000

Description

AOUT2.CUTOFF sets the cutoff frequency in Hz for a single-pole low-pass filter on the Analog Output 2.

A value of 0 Hz will turn off the filter and will allow all frequencies to pass through.

The filter can be used with all modes of Analog Output 2.

7.5.2 AOUT2.MODE

General Information	
Type	NV Parameter
Description	Sets the analog output 2 mode.
Units	N/A
Range	0
Default Value	0
Data Type	Integer
Start Version	M_01-06-03-000

Variants Supported

Supported by any AKD with extended IO.

Fieldbus Information

Fieldbus	Index/Subindex	Is 64 bit?	Attributes	Signed?	Object Start Version
Modbus	1276	No	16 bit	No	M_01-06-03-000

Description

AOUT2.MODE sets the analog output functionality.

Mode 0: User variable. The analog output 2 signal is determined by the user (using AOUT.VALUEU (pg 185)).

Example

You can use AOUT.MODE and AOUT.VALUEU to configure an output signal as follows:

```
-->AOUT.MODE 0
-->AOUT.VALUEU 5
-->AOUT.VALUEU 4.33
```

7.5.3 AOUT2.OFFSET

General Information	
Type	NV Parameter
Description	Sets the analog output 2 offset.
Units	V
Range	-10 to +10 V
Default Value	0 V
Data Type	Float
Start Version	M_01-06-03-000

Variants Supported

Supported by any AKD with extended IO.

Fieldbus Information

Fieldbus	Index/Subindex	Is 64 bit?	Attributes	Signed?	Object Start Version
Modbus	1278	No	16 bit	Yes	M_01-06-03-000

Description

This parameter sets the analog output 2 offset.

7.5.4 AOUT2.VALUE

General Information	
Type	R/O Parameter
Description	Reads the analog output 2 value.
Units	V
Range	-10 to +10 V
Default Value	0
Data Type	Float
Start Version	M_01-06-03-000

Variants Supported

Supported by any AKD with extended IO.

Fieldbus Information

Fieldbus	Index/Subindex	Is 64 bit?	Attributes	Signed?	Object Start Version
Modbus	1284	Yes	64 bit	Yes	M_01-06-03-000

Description

AOUT2.VALUE reads the analog output 2 value.

7.5.5 AOUT.VALUEU

General Information	
Type	R/W Parameter
Description	Sets the analog output 2 value.
Units	V
Range	-10 to +10 V
Default Value	0
Data Type	Float
Start Version	M_01-06-03-000

Variants Supported

Supported by any AKD with extended IO.

Fieldbus Information

Fieldbus	Index/Subindex	Is 64 bit?	Attributes	Signed?	Object Start Version
Modbus	1288	Yes	64 bit	Yes	M_01-06-03-000

Description

AOUT2.VALUEU reads/writes the analog output 2 value when AOUT2.MODE (pg 182) = 0 (analog output signal is determined by the user).

7.6 BODE Parameters

This section describes the BODE parameters.

7.6.1 BODE.EXCITEGAP	187
7.6.2 BODE.FREQ	188
7.6.3 BODE.IAMP	190
7.6.4 BODE.IFLIMIT	191
7.6.5 BODE.IFTHRESH	193
7.6.6 BODE.INJECTPOINT	195
7.6.7 BODE.MODE	197
7.6.8 BODE.MODETIMER	200
7.6.9 BODE.PRBDEPTH	202
7.6.10 BODE.VAMP	203
7.6.11 BODE.VFLIMIT	205
7.6.12 BODE.VFTHRESH	207

7.6.1 BODE.EXCITEGAP

General Information	
Type	R/W Parameter
Description	Controls how often the excitation is updated.
Units	Drive samples
Range	1 to 255 drive samples
Default Value	2 drive samples
Data Type	N/A
Start Version	M_01-00-00-000

Variants Supported

Variant	Supported
AKD Base	Yes
AKD with Position Indexer	Yes
AKD EtherCAT	Yes
AKD CANopen	Yes
AKD BASIC	Yes
AKD SynqNet	Yes
AKD EtherNet/IP	Yes
AKD Profinet	Yes
AKD sercos [®] III	Yes
AKD-N	Yes
AKD-C	No

Fieldbus Information

Fieldbus	Address	Attributes	Signed?
Profinet	2019	Byte	No
sercos [®] III		2 Octets	

Fieldbus	Index/Subindex	Is 64 bit?	Attributes	Signed?	Object Start Version
Modbus	38	No	8 bit	No	M_01-03-00-000

Description

BODE.EXCITEGAP controls how often the excitation is updated. The excitation is updated every n drive samples, where n is BODE.EXCITEGAP. For example, if BODE.EXCITEGAP = 2, then the excitation is updated every $2/(16,000 \text{ Hz}) = 1/8,000 \text{ Hz} = 0.000125 \text{ sec}$. When measuring a system, update the excitation only as often as the data is recorded.

Example

Set excitation update rate to 8,000 Hz:

```
-->BODE.EXCITEGAP 2
```

Set excitation update rate to 4,000 Hz:

```
-->BODE.EXCITEGAP 4
```

Get excitation update rate (already set to 8000 Hz):

```
-->BODE.EXCITEGAP 2
```

7.6.2 BODE.FREQ

General Information	
Type	R/W Parameter
Description	Sets the frequency of the sine excitation source.
Units	Hz
Range	0 to 8,000 Hz
Default Value	0 Hz
Data Type	Float
Start Version	M_01-00-00-000

Variants Supported

Variant	Supported
AKD Base	Yes
AKD with Position Indexer	Yes
AKD EtherCAT	Yes
AKD CANopen	Yes
AKD BASIC	Yes
AKD SynqNet	Yes
AKD EtherNet/IP	Yes
AKD Profinet	Yes
AKD sercos [®] III	Yes
AKD-N	Yes
AKD-C	No

Fieldbus Information

Fieldbus	Address	Attributes	Signed?
Profinet	2020	DWord	No
sercos [®] III		4 Octets	

Fieldbus	Index/Subindex	Is 64 bit?	Attributes	Signed?	Object Start Version
Modbus	40	No	32 bit	No	M_01-03-00-000

Description

BODE.FREQ sets the frequency of the sine excitation source in Hz. The sine excitation source is used to take frequency response measurements of a system.

Example

Setting up a sine excitation source of 0.2 A at 50 Hz:

```
-->BODE.INJECTPOINT 1
-->BODE.IAMP 0.2
-->BODE.FREQ 50.0
-->BODE.MODE 2
```

Related Topics

BODE.MODE (pg 197)

BODE.INJECTPOINT (pg 195)

BODE.VAMP (pg 203)

BODE.IAMP (pg 190)

7.6.3 BODE.IAMP

General Information	
Type	R/W Parameter
Description	Sets current command value used during the Bode procedure.
Units	A
Range	+/- Combined drive and motor current limit
Default Value	0.2 A
Data Type	Float
Start Version	M_01-00-00-000

Variants Supported

Variant	Supported
AKD Base	Yes
AKD with Position Indexer	Yes
AKD EtherCAT	Yes
AKD CANopen	Yes
AKD BASIC	Yes
AKD SynqNet	Yes
AKD EtherNet/IP	Yes
AKD Profinet	Yes
AKD sercos [®] III	Yes
AKD-N	Yes
AKD-C	No

Fieldbus Information

Fieldbus	Address	Attributes	Signed?
Profinet	2021	DWord	Yes
sercos [®] III		4 Octets	

Fieldbus	Index/Subindex	Is 64 bit?	Attributes	Signed?	Object Start Version
Modbus	42	No	32 bit	Yes	M_01-03-00-000

Description

BODE.IAMP sets the amplitude of the excitation when in current mode as set in BODE.INJECTPOINT. When using BODE.MODE (pg 197) = 1 and BODE.INJECTPOINT (pg 195) = 1, this parameter will determine the level of noise injected to commanded current value.

Example

Set the excitation current to 0.2 A:

```
-->BODE.IAMP 0.2
```

Get the excitation current (already set to 0.2 A):

```
-->BODE.IAMP 0.200 [A]
```

Related Topics

BODE.INJECTPOINT (pg 195) | BODE.FREQ (pg 188)

7.6.4 BODE.IFLIMIT

General Information	
Type	R/W Parameter
Description	Sets the current fault duration limit in seconds for the BODE.MODE 5 stability test.
Units	s
Range	0.001 to 60.000
Default Value	0
Data Type	Decimal
Start Version	M_01-02-10-000

Variants Supported

Variant	Supported
AKD Base	Yes
AKD with Position Indexer	Yes
AKD EtherCAT	Yes
AKD CANopen	Yes
AKD BASIC	Yes
AKD SynqNet	Yes
AKD EtherNet/IP	Yes
AKD Profinet	Yes
AKD sercos [®] III	Yes
AKD-N	Yes
AKD-C	No

Fieldbus Information

Fieldbus	Address	Attributes	Signed?
Profinet	2648	DWord	Yes
sercos [®] III		4 Octets	

Fieldbus	Index/Subindex	Is 64 bit?	Attributes	Signed?	Object Start Version
Modbus	1296	No	32 bit	Yes	M_01-06-03-000

Description

When BODE.MODE is set to 5, the firmware monitors the drive current (IL.CMD (pg 486)). When IL.CMD goes above BODE.IFTHRESH (pg 193), an internal counter records the length of time IL.CMD was above BODE.IFTHRESH. If the internal counter reaches BODE.IFLIMIT, Fault 133 – Instability during Autotune will be generated.

The smaller BODE.IFLIMIT, the quicker Fault 133 will be generated when IL.CMD exceeds BODE.IFLIMIT.

Example

Set BODE.IFTHRESH to 6 Amps:

```
-->BODE.IFTHRESH 6
```

Set BODE.IFLIMIT to 0.500 seconds:

```
-->BODE.IFLIMIT 0.5
```

Set BODE.MODE to 5 to enable stability detection:

```
BODE.MODE 5
```

Related Topics

BODE.MODE (pg 197), BODE.MODETIMER (pg 200), BODE.IFTHRESH (pg 193), BODE.VFLIMIT (pg 205), BODE.VFTHRESH (pg 207)

7.6.5 BODE.IFTHRESH

General Information	
Type	R/W Parameter
Description	Sets the current fault threshold for the BODE.MODE 5 stability test.
Units	A
Range	0.001 to DRV.IPEAK or MOTOR.IPEAK (whichever is lowest) A
Default Value	0 A
Data Type	Decimal
Start Version	M_01-02-10-000

Variants Supported

Variant	Supported
AKD Base	Yes
AKD with Position Indexer	Yes
AKD EtherCAT	Yes
AKD CANopen	Yes
AKD BASIC	Yes
AKD SynqNet	Yes
AKD EtherNet/IP	Yes
AKD Profinet	Yes
AKD sercos [®] III	Yes
AKD-N	Yes
AKD-C	No

Fieldbus Information

Fieldbus	Address	Attributes	Signed?
Profinet	2649	DWord	Yes
sercos [®] III		4 Octets	

Fieldbus	Index/Subindex	Is 64 bit?	Attributes	Signed?	Object Start Version
Modbus	1298	No	32 bit	Yes	M_01-06-03-000

Description

When BODE.MODE (pg 197) is set to 5, the firmware monitors the drive current (IL.CMD (pg 486)). When IL.CMD goes above BODE.IFTHRESH, an internal counter records the length of time IL.CMD was above BODE.IFTHRESH. If the internal counter reaches BODE.IFLIMIT (pg 191), Fault 133 (Instability during Autotune) is generated.

Example

Set BODE.IFTHRESH to 6 Amps:

```
-->BODE.IFTHRESH 6
```

Set BODE.IFLIMIT to 0.500 seconds:

```
-->BODE.IFLIMIT 0.5
```

Set BODE.MODE to 5 to enable stability detection:

```
BODE.MODE 5
```

Related Topics

BODE.MODE (pg 197), BODE.MODETIMER (pg 200), BODE.VFLIMIT (pg 205), BODE.VFTHRESH (pg 207) , BODE.IFLIMIT (pg 191)

7.6.6 BODE.INJECTPOINT

General Information	
Type	R/W Parameter
Description	Sets whether the excitation uses current or velocity excitation type.
Units	N/A
Range	0 to 2
Default Value	0
Data Type	Integer
Start Version	M_01-00-00-000

Variants Supported

Variant	Supported
AKD Base	Yes
AKD with Position Indexer	Yes
AKD EtherCAT	Yes
AKD CANopen	Yes
AKD BASIC	Yes
AKD SynqNet	Yes
AKD EtherNet/IP	Yes
AKD Profinet	Yes
AKD sercos [®] III	Yes
AKD-N	Yes
AKD-C	No

Fieldbus Information

Fieldbus	Address	Attributes	Signed?
Profinet	2022	Byte	No
sercos [®] III		2 Octets	

Fieldbus	Index/Subindex	Is 64 bit?	Attributes	Signed?	Object Start Version
Modbus	44	No	8 bit	No	M_01-03-00-000

Description

BODE.INJECTPOINT sets whether the excitation uses current or velocity excitation type.

BODE.INJECTPOINT	Description
0	None
1	Current
2	Velocity

Example

Set BODE.INJECTPOINT to current:

```
-->BODE.INJECTPOINT 1
```

Get BODE.INJECTPOINT (already set to current):

```
-->BODE.INJECTPOINT 1
```

Related Topics

BODE.IAMP (pg 190), BODE.MODE (pg 197), BODE.VAMP (pg 203)

7.6.7 BODE.MODE

General Information	
Type	R/W Parameter
Description	Sets the mode of the excitation.
Units	N/A
Range	0 to 4
Default Value	0
Data Type	Integer
Start Version	M_01-00-00-000

Variants Supported

Variant	Supported
AKD Base	Yes
AKD with Position Indexer	Yes
AKD EtherCAT	Yes
AKD CANopen	Yes
AKD BASIC	Yes
AKD SynqNet	Yes
AKD EtherNet/IP	Yes
AKD Profinet	Yes
AKD sercos [®] III	Yes
AKD-N	Yes
AKD-C	No

Fieldbus Information

Fieldbus	Address	Attributes	Signed?
Profinet	2023	Byte	No
sercos [®] III		2 Octets	

Fieldbus	Index/Subindex	Is 64 bit?	Attributes	Signed?	Object Start Version
Modbus	46	No	8 bit	No	M_01-03-00-000

Description

BODE.MODE sets the mode of the excitation. The excitation can be set to the modes shown in the table below. BODE.MODE is always set to **None** when Ethernet communication is disconnected. The peak amplitude of the excitation is set by either BODE.IAMP or BODE.VAMP (depending on BODE.INJECTPOINT).

BODE.MODE is subject to a watchdog timer (BODE.MODETIMER) as follows:

- If BODE.MODETIMER is 0, then BODE.MODE is not affected.
- If BODE.MODETIMER is set to a value greater than 0, then BODE.MODE will be set to 0 (None) after the BODE.MODETIMER time milliseconds.
- If BODE.MODE is a nonzero value, and you reset BODE.MODE to another nonzero value, you will reset the watchdog timer. This mechanism is intended to turn off the excitation signal if you lose communication with the drive.

BODE.MODE	Description	Comments
0	None	Turns all excitation off
1	PRB	Uses Pseudo Random Binary (PRB) excitation. PRB is a signal that is always +/- peak amplitude, varying only in phase. PRB excitation results in a flat excitation frequency spectrum. PRB results in a high peak excitation amplitude, which can help minimize friction in a frequency response test. PRB excitation repeats every $(2^{BODE.PRBDDEPTH}) / BODE.EXCITEGAP$ drive samples. This repetition can be used to reveal the effects of friction.
2	Sine	Uses Sine excitation
3	Noise	Uses random noise excitation. Noise is a random number generator that varies between +/- peak amplitude.
4	Offset	Sets a torque offset equal to BODE.IAMP

Example

Set BODE.MODE to PRB:

```
-->BODE.MODE 1
```

Get BODE.MODE (already set to PRB):

```
-->BODE.MODE 1
```

PRB excitation:

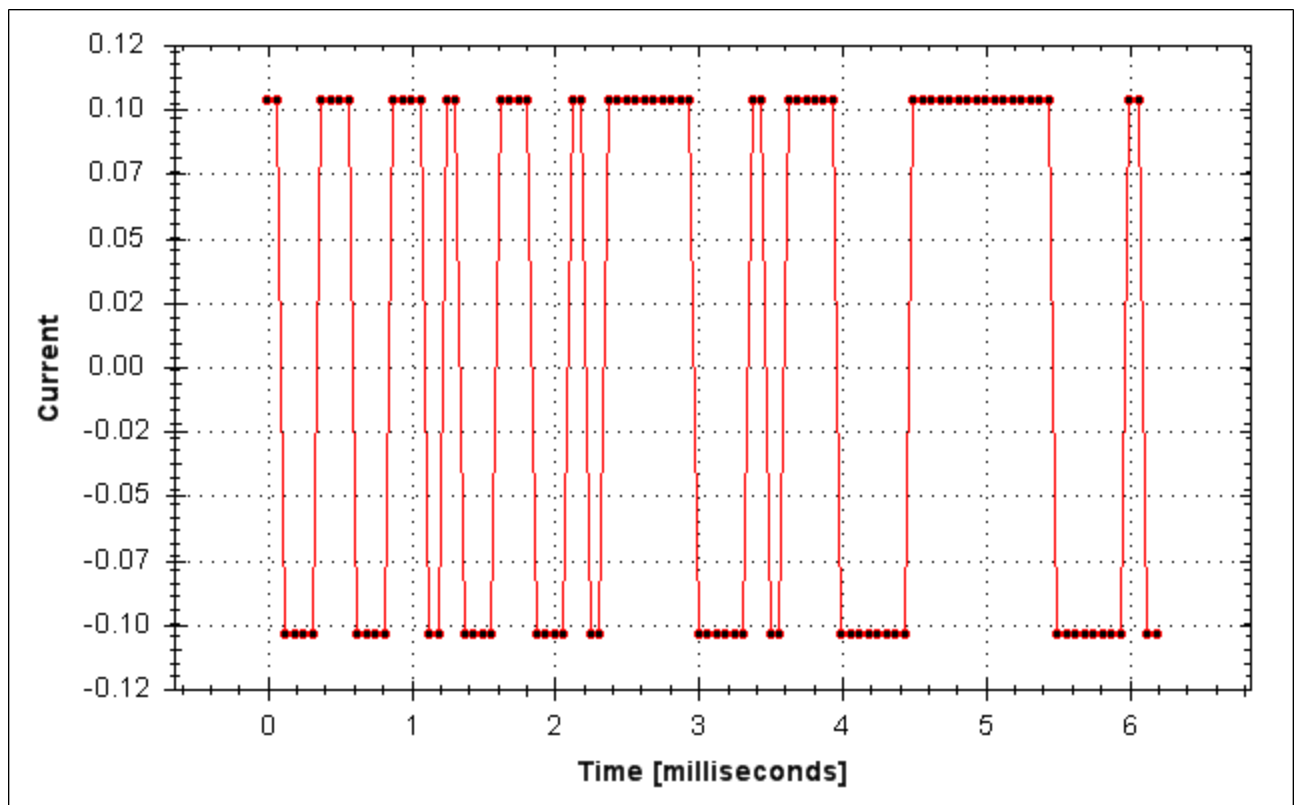

Sine excitation:

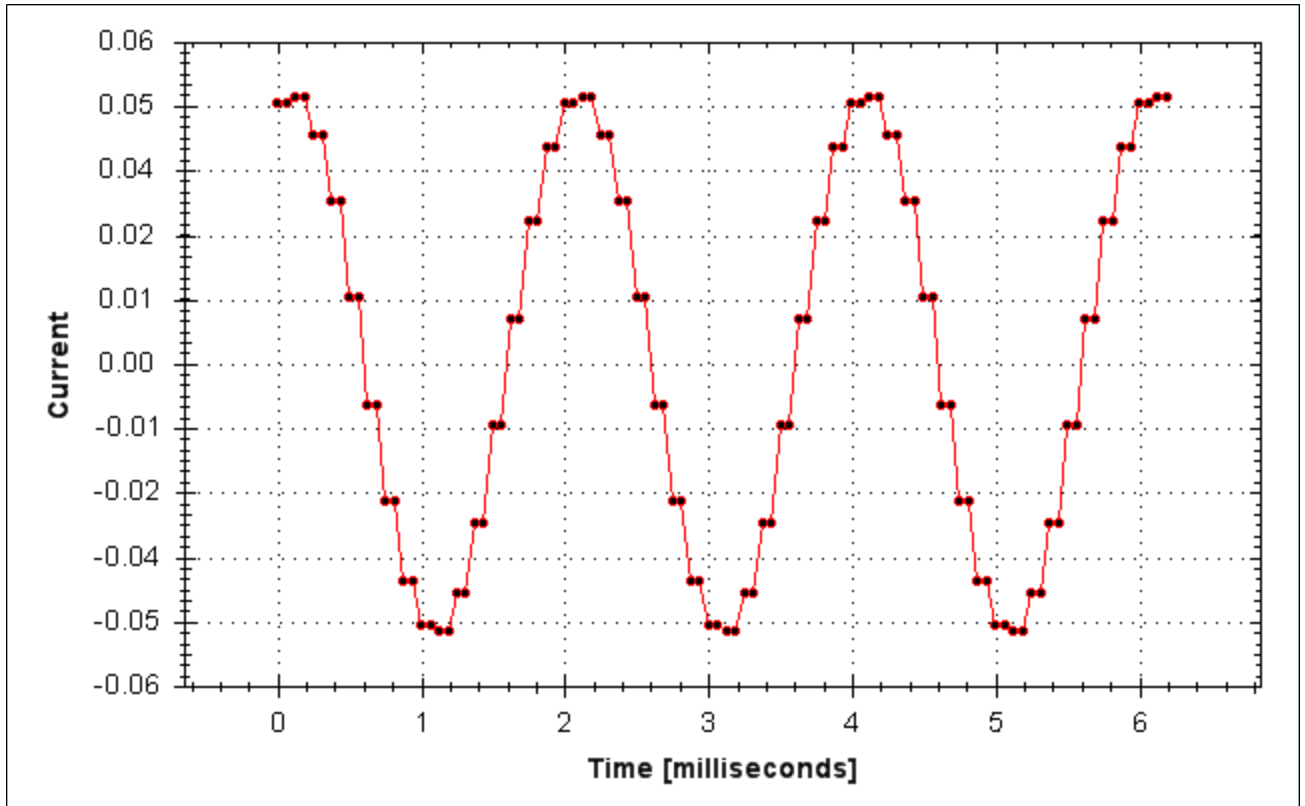

Noise excitation:

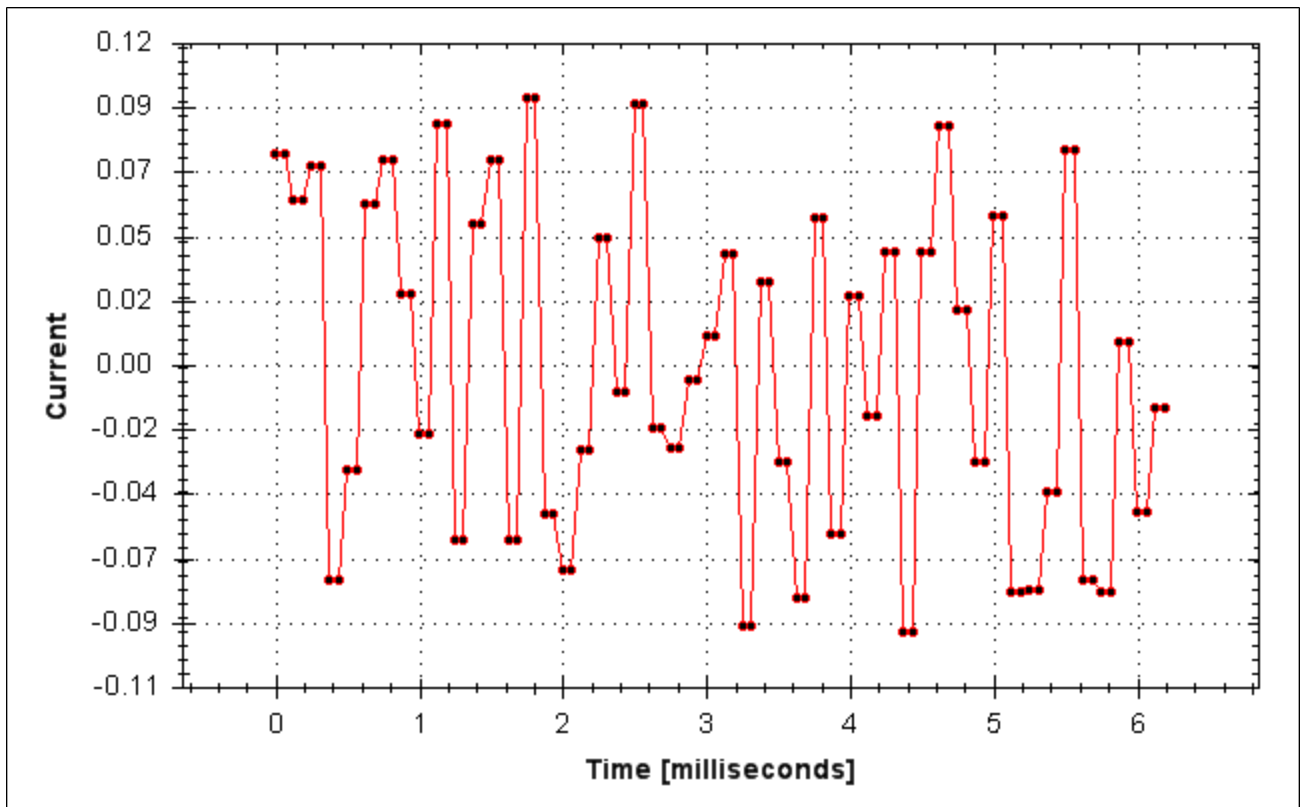

Related Topics

BODE.INJECTPOINT (pg 195) BODE.VAMP (pg 203)

7.6.8 BODE.MODETIMER

General Information	
Type	R/W Parameter
Description	Sets the watchdog timer of the excitation.
Units	ms
Range	0 to 268,435,456
Default Value	0
Data Type	Integer
Start Version	M_1-03-00-000

Variants Supported

Variant	Supported
AKD Base	Yes
AKD with Position Indexer	Yes
AKD EtherCAT	Yes
AKD CANopen	Yes
AKD BASIC	Yes
AKD SynqNet	Yes
AKD EtherNet/IP	Yes
AKD Profinet	Yes
AKD sercos [®] III	Yes
AKD-N	Yes
AKD-C	No

Fieldbus Information

Fieldbus	Address	Attributes	Signed?
Profinet	2024	DWord	No
sercos [®] III		4 Octets	

Fieldbus	Index/Subindex	Is 64 bit?	Attributes	Signed?	Object Start Version
Modbus	48	No	32 bit	No	M_01-03-00-000

Description

BODE.MODETIMER sets the watchdog timer for the excitation. This watchdog is used to automatically turn off the excitation of the system if communication is lost. It is highly recommended that you use the watchdog for any excitation measurements. The WorkBench Performance Servo Tuner and Bode tool automatically use these values, requiring no action from you.

If the BODE.MODETIMER is a nonzero value, the Bode watchdog is enabled. BODE.MODE will be set to 0 (None) after the BODE.MODETIMER value elapses. To reset the watchdog timer, reset BODE.MODE to a nonzero value.

BODE.MODETIMER	Comments
0	BODE.MODE is left at the value you set it to.

BODE.MODETIMER	Comments
<p style="text-align: center;">> 0</p>	<p>Uses pseudo random binary (PRB) excitation. PRB is a signal that is always +/- peak amplitude, varying only in phase.</p> <p>PRB excitation results in a flat excitation frequency spectrum. PRB also results in a high peak excitation amplitude, which can help minimize friction in a frequency response test.</p> <p>PRB excitation repeats every $(2^{\text{BODE.PRBDEPTH}})/\text{BODE.EXCITEGAP}$ drive samples. This repetition can be used to reveal the effects of friction.</p>

Example

Disable BODE.MODETIMER:

```

->BODE.MODETIMER //
Set to 0 to disable the watchdog
0
->BODE.MODE // Observe starting state of the Bode mode
0
->BODE.MODE 1 // Set Bode mode to PRB
->BODE.MODE // Observe Bode mode state is the same after 0.5 seconds
1
->BODE.MODE // Observe Bode mode state is the same after 10 seconds
1

```

Enable BODE.MODETIMER:

```

->BODE.MODETIMER 1000 // Set watchdog to 1 second
->BODE.MODE 1 // Set Bode mode to PRB
->BODE.MODE // Observe Bode mode state is the same after 0.5 seconds
1
->BODE.MODE // Observe Bode mode state has been set to zero after 1.0 seconds
0

```

Enable and renewable BODE.MODETIMER:

```

->BODE.MODETIMER 2500 // Set watchdog to 2.5 seconds
->BODE.MODE 1 // Set Bode mode to PRB
->BODE.MODE // Observe Bode mode state is the same after 1.5 seconds
1
->BODE.MODE 1 // Set Bode mode to PRB, resetting the watchdog timer to the original 2.5 second
value
set above.
->BODE.MODE // Observe Bode mode state is the same after 3.0 seconds after the original enabling of
BODE.MODE 1
->BODE.MODE // Observe Bode mode state has been set to zero after 4.0 seconds after the original
enabling
of BODE.MODE
0

```

Related Topics

BODE.MODE (pg 197)

7.6.9 BODE.PRBDDEPTH

General Information	
Type	R/W Parameter
Description	Sets the length of the PRB signal before it repeats.
Units	NA
Range	4 to 19
Default Value	19
Data Type	Integer
Start Version	M_01-00-00-000

Variants Supported

Variant	Supported
AKD Base	Yes
AKD with Position Indexer	Yes
AKD EtherCAT	Yes
AKD CANopen	Yes
AKD BASIC	Yes
AKD SynqNet	Yes
AKD EtherNet/IP	Yes
AKD Profinet	Yes
AKD sercos [®] III	Yes
AKD-N	Yes
AKD-C	No

Fieldbus Information

Fieldbus	Address	Attributes	Signed?
Profinet	2025	Byte	No
sercos [®] III		2 Octets	

Fieldbus	Index/Subindex	Is 64 bit?	Attributes	Signed?	Object Start Version
Modbus	50	No	8 bit	No	M_01-03-00-000

Description

BODE.PRBDDEPTH sets the length of the PRB signal before it repeats. This applies only when BODE.MODE = PRB. The PRB excitation will repeat after $(2^{\text{BODE.PRBDDEPTH}}) / \text{BODE.EXCITEGAP}$ drive samples.

Example

Set BODE.PRBDDEPTH to 19:

```
-->BODE.PRBDDEPTH 19
```

Get BODE.PRBDDEPTH (already set to 19):

```
-->BODE.PRBDDEPTH 19
```

Related Topics

BODE.MODE (pg 197), BODE.INJECTPOINT (pg 195), BODE.IAMP (pg 190), BODE.VAMP (pg 203)

7.6.10 BODE.VAMP

General Information	
Type	R/W Parameter
Description	Sets the amplitude of the excitation when in velocity mode.
Units	Depends on UNIT.VROTARY (pg 720) or UNIT.VLINEAR (pg 719)UNIT.ACCLINEAR (pg 712) Rotary: rpm, rps, deg/s, Custom Units/V, rad/s Linear: counts/s, mm/s, µm/s, Custom Units/V
Range	Rotary: 0.000 to 15,000.000 rpm 0.000 to 250.000 rps 0.000 to 90,000.000 degree/s 0.000 to 1,250.000 Custom Units/s 0.000 to 1,570.796 rad/s Linear: 0.000 to 1,073,741,824,000.000 counts/s 0.000 to 8,000.000 mm/s 0.000 to 8,000,000.000 µm/s 0.000 to 1,250.000 Custom Units/s
Default Value	0
Data Type	Float
Start Version	M_01-00-00-000

Variants Supported

Variant	Supported
AKD Base	Yes
AKD with Position Indexer	Yes
AKD EtherCAT	Yes
AKD CANopen	Yes
AKD BASIC	Yes
AKD SynqNet	Yes
AKD EtherNet/IP	Yes
AKD Profinet	Yes
AKD sercos [®] III	Yes
AKD-N	Yes
AKD-C	No

Fieldbus Information

Fieldbus	Parameter	Address	Attributes	Signed?
Profinet	BODE.VAMPE_32	2026	DWord	Yes
sercos [®] III			8 Octets	

Fieldbus	Index/Subindex	Is 64 bit?	Attributes	Signed?	Object Start Version
Modbus	52	Yes	Low 32 bit word	Yes	M_01-03-00-000

Description

BODE.VAMP sets the amplitude of the excitation when in velocity mode as set in BODE.INJECTPOINT.

Example

Set the excitation velocity to 100 RPM

```
-->BODE.VAMP 100
```

Get the excitation velocity(already set to 100 RPM)

```
-->BODE.VAMP
```

100.000 [rpm]

Related Topics

BODE.MODE (pg 197), BODE.INJECTPOINT (pg 195)

7.6.11 BODE.VFLIMIT

General Information	
Type	R/W Parameter
Description	Sets the velocity fault duration limit (seconds) for the BODE.MODE 5 stability test
Units	s
Range	0.001 to 60.000
Default Value	0
Data Type	Decimal
Start Version	M_01-02-10-000

Variants Supported

Variant	Supported
AKD Base	Yes
AKD with Position Indexer	Yes
AKD EtherCAT	Yes
AKD CANopen	Yes
AKD BASIC	Yes
AKD SynqNet	Yes
AKD EtherNet/IP	Yes
AKD Profinet	Yes
AKD sercos [®] III	Yes
AKD-N	Yes
AKD-C	No

Fieldbus Information

Fieldbus	Address	Attributes	Signed?
Profinet	2650	DWord	Yes
sercos [®] III		4 Octets	

Fieldbus	Index/Subindex	Is 64 bit?	Attributes	Signed?	Object Start Version
Modbus	1300	No	32 bit	Yes	M_01-06-03-000

Description

When BODE.MODE is set to 5, the firmware monitors the drive feedback velocity VL.FB. When VL.FB goes above BODE.VFTHRESH, an internal counter records the length of time VL.FB was above BODE.VFTHRESH. If the internal counter reaches BODE.VFLIMIT, Fault 133 – Instability during Auto-tune will be generated.

The smaller BODE.VFLIMIT, the quicker Fault 133 will be generated when VL.FB exceeds BODE.VFLIMIT.

Example

Set BODE.VFTHRESH to 10 RPM:

```
-->BODE.VFTHRESH 10
```

Set BODE.VFLIMIT to 0.500 seconds

```
-->BODE.VFLIMIT 0.5
```

Set BODE.MODE to 5 to enable stability detection

-->BODE.MODE 5

Related Topics

BODE.MODE, BODE.MODETIMER, BODE.IFLIMIT, BODE.IFTHRESH, BODE.VFTHRESH

7.6.12 BODE.VFTHRESH

General Information	
Type	R/W Parameter
Description	Sets the current fault threshold for the BODE.MODE 5 stability test.
Units	Depends on UNIT.VROTARY (pg 720) or UNIT.VLINEAR (pg 719)UNIT.ACCLINEAR (pg 712) Rotary: rpm, rps, deg/s, Custom Units/V, rad/s Linear: counts/s, mm/s, µm/s, Custom Units/V
Range	Rotary: 0.000 to 15,000.000 rpm 0.000 to 250.000 rps 0.000 to 90,000.000 deg/s 0.000 to 1,250.000 Custom Units/s 0.000 to 1,570.796 rad/s Linear: 0.000 to 1,073,741,824,000.000 counts/s 0.000 to 8,000.000 mm/s 0.000 to 8,000,000.000 µm/s
Default Value	0
Data Type	Decimal
Start Version	M_01-02-10-000

Variants Supported

Variant	Supported
AKD Base	Yes
AKD with Position Indexer	Yes
AKD EtherCAT	Yes
AKD CANopen	Yes
AKD BASIC	Yes
AKD SynqNet	Yes
AKD EtherNet/IP	Yes
AKD Profinet	Yes
AKD sercos [®] III	Yes
AKD-N	Yes
AKD-C	No

Fieldbus Information

Fieldbus	Address	Attributes	Signed?
Profinet	2651	DWord	Yes
sercos [®] III		8 Octets	

Fieldbus	Index/Subindex	Is 64 bit?	Attributes	Signed?	Object Start Version
Modbus	1302	Yes	64 bit	Yes	M_01-06-03-000

Description

When BODE.MODE is set to 5, the firmware monitors the drive feedback velocity VL.FB. When VL.FB goes above BODE.VFTHRESH, an internal counter records the length of time VL.FB was above BODE.VFTHRESH. If the internal counter reaches BODE.VFLIMIT, Fault 133 – Instability during Auto-tune will be generated.

The smaller BODE.VFLIMIT, the quicker Fault 133 will be generated when VL.FB exceeds BODE.VFLIMIT.

Example

Set BODE.VFTHRESH to 10 RPM:

```
-->BODE.VFTHRESH 10
```

Set BODE.VFLIMIT to 0.500 seconds:

```
-->BODE.VFLIMIT 0.5
```

Set BODE.MODE to 5 to enable stability detection:

```
-->BODE.MODE 5
```

Related Topics

BODE.MODE, BODE.MODETIMER, BODE.IFLIMIT, BODE.IFTHRESH, BODE.VFLIMIT

7.7 CAM Parameters

This section describes the CAM parameters.

7.7.1 CAM.ACTIVATE	210
7.7.2 CAM.ADDPOINT	212
7.7.3 CAM.CORRECTDIR	214
7.7.4 CAM.CREATE	215
7.7.5 CAM.MASTER	217
7.7.6 CAM.MASTERPOS	218
7.7.7 CAM.SLAVEOFFSET	219
7.7.8 CAMVM.DIR	220
7.7.9 CAMVM.FREQ	221
7.7.10 CAMVM.GOREL	222
7.7.11 CAMVM.GOUPDATE	223
7.7.12 CAMVM.GOVEL	224
7.7.13 CAMVM.MOVING	225
7.7.14 CAMVM.POSITION	226
7.7.15 CAMVM.RELATIVEDIST	227
7.7.16 CAMVM.STOP	228

7.7.1 CAM.ACTIVATE

General Information	
Type	Parameter
Description	Activates the specified cam table.
Units	None
Range	0 to 8
Default Value	0
Data Type	Integer
Start Version	M_01-06-00-000

Description

CAM.ACTIVATE activates the specified cam table. The Position Command is calculated according to the Master Position and the points in the specified cam table.

When you activate a new cam, the drive accelerates (at EGEAR.ACCLIMIT) or decelerates (at EGEAR.DECLIMIT) as necessary to the speed required by the present motion of the Cam Master and the slave position profile defined in the cam table.

When speed synchronization is achieved, EGEAR.LOCK is set to one and a correction move is performed to bring the slave into position lock with the cam table. The direction of this move is controlled by CAM.CORRECTDIR. The parameters of this correction move are the same as for any other move (i.e., MOVE.ACC, MOVE.DEC, MOVE.RUNSPEED).

If the master is not moving or if the slave position profile in the cam table does not require cam motion when the cam is activated, the speed synchronization occurs instantly and the correction move is executed as soon as the cam is activated.

CAM.ACTIVATE is automatically set to zero (i.e., any cam is disengaged) when the drive is disabled.

To disable the correction move, set CAM.CORRECTDIR = 3.

You must declare and create a cam table before you make it active. If MOVE.RUNSPEED is equal to zero when you set CAM.ACTIVATE, a run-time error is generated because the correction move cannot be performed.

Examples

The following example declares, creates, and activates a cam.

```
'----- Device Params -----
Params
  DRV.OPMODE = 2 'position operation mode
  DRV.CMDSOURCE = 5 'command source = AKD BASIC TG
  UNIT.PROTARY = 4 '16 bit position units, 65536 counts/rev
  UNIT.VROTARY = 0 'velocity units = rpm
  UNIT.ACCROTARY = 0 'acceleration units = rpm/sec
  PL.MODPEN = 1 'enable slave modulo
  PL.MODP2 = 65536 'set slave (AKD BASIC) counts per cycle
  FB2.SOURCE = 1 'set Master Encoder Source to X9
  FB2.ENCREAS = 8000 'set counts'rev of Master
  FB2.DIR = 0 'set counting direction for Master Encoder
  EXTENCODER.POSMODULO = 8000 'set master counts per cycle
End Params
'----- Define (dim) Global Variables -----
'----- Main Program -----
```

```
Main
  'start the cam create block
  CAM.CREATE (1, 5) 'allocate space for cam #1, 5 points
    'add the points
    CAM.ADDPOINT(0, 0)
    CAM.ADDPOINT(2000, 65536 / 10)
    CAM.ADDPOINT(4004, 65536 / 8)
    CAM.ADDPOINT(6000, 65536 * 3 / 4)
    CAM.ADDPOINT(8000, 65536)
  End 'the cam create block
  CAM.MASTER = 2 'Cam Master = External Encoder
  EXTENCODER.POSITION = 0 'set Master position to 0
  MOVE.POSCOMMAND = 0 'set slave (AKD BASIC) position to 0
  DRV.SWENABLE = 1 'enable the motor
  Print "Motor Enabled, wait 5 sec"
  Pause (5)
  CAM.ACTIVATE = 1 'activate cam #1
  Print "CAM Enabled"
  While 1 = 1 : wend
End Main
```

Related Topics

CAM.CORRECTDIR (pg 214)

7.7.2 CAM.ADDPOINT

General Information	
Type	Statement
Description	CAM.ADDPOINT(Master Position, Slave Position) Adds the specified "point" to the cam table being created.
Units	Master Encoder Counts, Position User Units
Range	-2 ⁶³ to 2 ⁶³ -1
Default Value	N/A
Data Type	Integer
Start Version	M_01-06-00-000

Description

CAM.ADDPOINT adds the specified "point" (master position and corresponding slave position) to the cam table being created. This statement is only used inside a CAM.CREATE block.

You must be inside a CAM.CREATE block to use the CAM.ADDPOINT statement. The master position for the first CAM.ADDPOINT statement in a CAM.CREATE block must always be zero. The master position must always increase as you add points to the cam table. There must be at least two points in your cam table.

FB2.ENCREAS (pg 451) and FB2.DIR (pg 456) are used to convert cam master position from user units to internal units. The BASIC program must set FB2.ENCREAS, FB2.DIR, and EXTENCODER.POSMODULO (pg 405) before calling CAM.ADDPOINT.

Examples

The following example declares, creates, and activates a cam.

```
'----- Device Params -----
Params
  DRV.OPMODE = 2 'position operation mode
  DRV.CMDSOURCE = 5 'command source = AKD BASIC TG
  UNIT.PROTARY = 4 '16 bit position units, 65536 counts/rev
  UNIT.VROTARY = 0 'velocity units = rpm
  UNIT.ACCROTARY = 0 'acceleration units = rpm/sec
  PL.MODPEN = 1 'enable slave modulo
  PL.MODP2 = 65536 'set slave (AKD BASIC) counts per cycle
  FB2.SOURCE = 1 'set Master Encoder Source to X9
  FB2.ENCREAS = 8000 'set counts/rev of Master
  FB2.DIR = 0 'set counting direction for Master Encoder
  EXTENCODER.POSMODULO = 8000 'set master counts per cycle
End Params
'----- Define (dim) Global Variables -----
'----- Main Program -----
Main
  'start the cam create block
  CAM.CREATE (1, 5) 'allocate space for cam #1, 5 points
    'add the points
    CAM.ADDPOINT (0, 0)
    CAM.ADDPOINT (2000, 65536 / 10)
```

```
CAM.ADDPOINT(4004, 65536 / 8)
CAM.ADDPOINT(6000, 65536 * 3 / 4)
CAM.ADDPOINT(8000, 65536)
End 'the cam create block
CAM.MASTER = 2 'Cam Master = External Encoder
EXTENCODER.POSITION = 0 'set Master position to 0
MOVE.POSCOMMAND = 0 'set slave (AKD BASIC) position to 0
DRV.SWENABLE = 1 'enable the motor
Print "Motor Enabled, wait 5 sec"
Pause (5)
CAM.ACTIVATE = 1 'activate cam #1
Print "CAM Enabled"
While 1 = 1 : wend
End Main
```

7.7.3 CAM.CORRECTDIR

General Information	
Type	R/W
Description	Specifies the direction of the correction move when a new cam table is activated (set CAM.ACTIVATE = n) or when speed synchronization is achieved.
Units	None
Range	0 to 3
Default Value	2 (shortest distance)
Data Type	Integer
Start Version	M_01-06-00-000

Description

CAM.CORRECTDIR takes one of the following values:

- 0 move is done clockwise
- 1 move is done counter-clockwise
- 2 move is done in the direction yielding the shortest move (see below)
- 3 no correction move is performed.

Use MOVE.ACC, MOVE.DEC and MOVE.RUNSPEED for the correction move. Even if CAM.CORRECTDIR specifies a clockwise correction move, it only specifies the direction of the super-imposed move. If the cam generated speed is the opposite direction and larger than MOVE.RUNSPEED, the slave slows down.

For CAM.CORRECTDIR = 2, the direction of the correction is calculated (based upon PosModulo) to yield the shortest distance move. For example, if PosModulo = 10000 and the clockwise correction move is 8000, a counter-clockwise move of 2000 is performed instead.

Example

In the following example, the correction move is in the direction yielding the shortest move distance.

```

....
`The cam table for Cam #1 needs to have been
`already declared and created
`_____
CAM.CORRECTDIR = 2
CAM.ACTIVATE = 1
....

```

Related Topics

CAM.ACTIVATE (pg 210)

7.7.4 CAM.CREATE

General Information	
Type	Statement
Description	CAM.CREATE (x, y) Initiates the creation of a cam table.
Units	N/A
Range	x = 1-8, y = 3-1000
Default Value	N/A
Data Type	Integers
Start Version	M_01-06-00-000

Description

CAM.CREATE initiates the creation of a cam table. The actual points in the cam table are inserted with a series of CAM.ADDPOINT statements. The CAM.CREATE block must be terminated by an End statement.

You can create a cam table as many times as you want. You must create a cam table before you make it active. You cannot create a cam table if it is active. The master position for the first entry must be 0. The master positions must keep increasing as you add points. EXTENCODER.POSMODULO must equal the total master distance in your CAM. For a repeating CAM, PL.MODP2 should be set equal to the distance that the slave travels in one CAM cycle.

Examples

```
'----- Device Params -----
Params
  DRV.OPMODE = 2 'position operation mode
  DRV.CMDSOURCE = 5 'command source = AKD BASIC TG
  UNIT.PROTARY = 4 '16 bit position units, 65536 counts/rev
  UNIT.VROTARY = 0 'velocity units = rpm
  UNIT.ACROTARY = 0 'acceleration units = rpm/sec
  PL.MODPEN = 1 'enable slave modulo
  PL.MODP2 = 65536 'set slave (AKD BASIC) counts per cycle
  FB2.SOURCE = 1 'set Master Encoder Source to X9
  FB2.ENCRES = 8000 'set counts'rev of Master
  FB2.DIR = 0 'set counting direction for Master Encoder
  EXTENCODER.POSMODULO = 8000 'set master counts per cycle
End Params
'----- Define (dim) Global Variables -----
'----- Main Program -----
Main
  'start the cam create block
  CAM.CREATE (1, 5)'allocate space for cam #1, 5 points
    'add the points
    CAM.ADDPOINT(0, 0)
    CAM.ADDPOINT(2000, 65536 / 10)
    CAM.ADDPOINT(4004, 65536 / 8)
    CAM.ADDPOINT(6000, 65536 * 3 / 4)
    CAM.ADDPOINT(8000, 65536)
  End 'the cam create block
  CAM.MASTER = 2 'Cam Master = External Encoder
  EXTENCODER.POSITION = 0 'set Master position to 0
  MOVE.POSCOMMAND = 0 'set slave (AKD BASIC) position to 0
```

```
DRV.SWENABLE = 1 'enable the motor
Print "Motor Enabled, wait 5 sec"
Pause (5)
CAM.ACTIVATE = 1 'activate cam #1
Print "CAM Enabled"
While 1 = 1 : wend
End Main
```

Related Topics

[CAM.ADDPOINT \(pg 212\)](#) | [CAM.ACTIVATE \(pg 210\)](#)

7.7.5 CAM.MASTER

General Information	
Type	R/W
Description	Specifies the source of the input to the cam table for cam profiling.
Units	None
Range	0 to 2
Default Value	0
Data Type	Integer
Start Version	M_01-06-00-000

Description

CAM.MASTER takes one of the following values:

Value	Description
0	EXTENCODER.POSITION + CAMVM.POSITION
1	CAMVM.POSITION only (EXTENCODER.POSITION is ignored)
2	EXTENCODER.POSITION only (CAMVM.POSITION is ignored)

Related Topics

CAM.MASTERPOS (pg 218)

7.7.6 CAM.MASTERPOS

General Information	
Type	R/O
Description	Gives the value of the master position presently being used as the input to the cam table.
Units	Encoder counts
Range	0 to EXTENCODER.POSMODULO
Default Value	N/A
Data Type	Integer
Start Version	M_01-06-00-000

Description

The value of CAM.MASTERPOS depends upon EXTENCODER.POSITION, CAMVM.POSITION and CAM.MASTER as follows:

Value of CAM.MASTER	Value of CAM.MASTERPOS
0	CAMVM.POSITION + EXTENCODER.POSITION
1	CAMVM.POSITION
2	EXTENCODER.POSITION

Related Topics

CAM.MASTER (pg 217) | DRV.HANDWHEEL (pg 343) | CAMVM.POSITION (pg 226)

7.7.7 CAM.SLAVEOFFSET

General Information	
Type	R/O
Description	CAM.SLAVEOFFSET indicates the offset (or difference) between MOVE.POSCOMMAND and the position command that is calculated from the active cam table based upon the present value of EXTENCODER.POSITION and/or CAMVM.POSITION.
Units	Depends on UNIT.PROTARY (pg 718) or UNIT.PLINEAR (pg 716)UNIT.ACCLINEAR (pg 712) Rotary: counts, rad, deg, (Custom Units), 16-bit counts Linear: counts, mm, μ m, (Custom Units), 16-bit counts
Range	N/A
Default Value	0
Data Type	Integer
Start Version	M_01-06-00-000

Description

CAM.SLAVEOFFSET indicates the offset (or difference) between PL.CMD and the position command that is calculated from the active cam table based upon the present value of DRV.HANDWHEEL and/or CAMVM.POSITION. This offset is the result of incremental (MOVE.GOREL) or velocity (MOVE.GOVEL) moves superimposed (by the user) on the cam table. If there is no active cam (CAM.ACTIVE = 0), the value of this variable is undefined.

7.7.8 CAMVM.DIR

General Information	
Type	R/W
Description	Specifies the direction the virtual encoder goes when CAMVM.GOVEL is executed.
Units	None
Range	0, 1
Default Value	0
Data Type	Integer
Start Version	M_01-06-00-000

Description

CAMVM.DIR specifies the direction the virtual encoder goes when CAMVM.GOVEL is executed. It also sets the direction of the virtual encoder when CAMVM.GOUPDATE is executed if the virtual encoder is performing a CAMVM.GOVEL move.

0 is positive

1 is negative

Example

```
'This runs the virtual encoder forward at 20,000 counts/sec
CAMVM.FREQ = 20000
CAMVM.DIR = 0
CAMVM.GOVEL
pause (5)
'This runs the virtual encoder backwards at 40,000 counts/sec
CAMVM.FREQ = 40000
CAMVM.DIR = 1
CAMVM.GOVEL
```

Related Topics

CAMVM.GOVEL (pg 224) | FB2.ENCRESES (pg 451)

7.7.9 CAMVM.FREQ

General Information	
Type	R/W
Description	CAMVM.FREQ sets the maximum frequency allowed during a relative (CAMVM.GOREL) move, and sets the commanded speed during a velocity move (CAMVM.GOVEL)
Units	Encoder counts/second
Range	0 to 1,000,000
Default Value	10,000
Data Type	Integer
Start Version	M_01-06-00-000

Description

CAMVM.FREQ sets the maximum frequency allowed during a relative (CAMVM.GOREL) move, and sets the commanded speed during a velocity move (CAMVM.GOVEL).

Example

```
'This will run the virtual encoder forward at 20,000 counts/sec
'-----
CAMVM.FREQ = 20000
CAMVM.DIR = 0
CAMVM.GOVEL
```

Related Topics

FB2.ENCREG (pg 451)

7.7.10 CAMVM.GOREL

General Information	
Type	Statement
Description	Makes the virtual master move the distance specified by CAMVM.RELATIVEDIST.
Units	None
Range	N/A
Default Value	N/A
Data Type	N/A
Start Version	M_01-06-00-000

Description

CAMVM.GOREL (Go Relative) causes the virtual master to move a distance specified by CAMVM.RELATIVEDIST. The virtual master runs at the frequency specified by CAMVM.FREQ. Use CAMVM.GOUPDATE to modify this frequency during the move.

Program execution continues with the line immediately following the CAMVM.GOREL statement as soon as the move is initiated. Program execution does not wait until the move is complete. The drive does not need to be enabled in order for to use the virtual master.

Related Topics

CAMVM.GOVEL (pg 224) | CAMVM.STOP (pg 228) | CAMVM.GOUPDATE (pg 223) | FB2.ENCRESES (pg 451)

7.7.11 CAMVM.GOUPDATE

General Information	
Type	Statement
Description	Updates a move in progress with new move parameters.
Units	N/A
Range	N/A
Default Value	N/A
Data Type	N/A
Start Version	M_01-06-00-000

Description

Updates a move in progress with new move parameters. This allows you to change motion on-the-fly without having to stop motion and initiate a new move. CAMVM.GOUPDATE updates CAMVM.DIR (for a CAMVM.GOVEL) and CAMVM.FREQ (for a CAMVM.GOVEL or CAMVM.GOREL).

Program execution continues with the line immediately following CAMVM.GOUPDATE as soon as the move is initiated. Program execution does not wait until the move is complete. CAMVM.GOUPDATE does not initiate motion if there is no move in progress.

Related Topics

CAMVM.GOREL (pg 222) | CAMVM.GOREL (pg 222) | FB2.ENCRESES (pg 451)

7.7.12 CAMVM.GOVEL

General Information	
Type	Statement
Description	CAMVM.GOVEL (Go at Velocity) causes the virtual master to move continuously at the frequency specified by CAMVM.FREQ in the direction (positive or negative) specified by CAMVM.DIR. The frequency or direction is modified during the move using CAMVM.GOUPDATE.
Units	N/A
Range	N/A
Default Value	N/A
Data Type	N/A
Start Version	M_01-06-00-000

Description

CAMVM.GOVEL (Go at Velocity) causes the virtual master to move continuously at the frequency specified by CAMVM.FREQ in the direction (positive or negative) specified by CAMVM.DIR. The frequency or direction is modified during the move using CAMVM.GOUPDATE.

When the move is initiated, program execution continues with the line immediately following CAMVM.GOVEL. Program execution does not wait until the move is complete. CAMVM.STOP stops a velocity move on the virtual encoder. Executing CAMVM.GOREL after CAMVM.GOVEL and before CAMVM.STOP causes the virtual encoder to switch to an incremental move that terminates when CAMVM.RELATIVEDIST encoder counts have been put out. The drive does not need to be enabled to use the virtual master.

Example

This runs the virtual encoder forward at 20,000 counts/sec

```
CAMVM.FREQ = 20000
CAMVM.DIR = 0
CAMVM.GOVEL
```

Related Topics

CAMVM.GOREL (pg 222) | CAMVM.STOP (pg 228) | CAMVM.GOUPDATE (pg 223) | FB2.ENCRESP (pg 451)

7.7.13 CAMVM.MOVING

General Information	
Type	R/O
Description	Indicates if the virtual encoder is moving.
Units	None
Range	0, 1
Default Value	N/A
Data Type	Integer
Start Version	M_01-06-00-000

Description

CAMVM.MOVING indicates if the virtual encoder is moving.

- 0 - virtual encoder is not moving
- 1 - virtual encoder is moving

Example

```

`Start an incremental move on the virtual encoder
CAMVM.FREQ = 10000
CAMVM.RELATIVEDIST = 123456
CAMVM.GOREL
DRV.TIME = 0
while CAMVM.MOVING : wend
print DRV.TIME

```

Related Topics

CAMVM.GOVEL (pg 224) | CAMVM.GOREL (pg 222) | FB2.ENCRESES (pg 451)

7.7.14 CAMVM.POSITION

General Information	
Type	R/W
Description	Contains the current value of the virtual encoder counter.
Units	counts
Range	0 to (EXTENCODER.POSMODULO - 1)
Default Value	0
Data Type	Integer
Start Version	M_01-06-00-000

Description

Control the virtual encoder using CAMVM.GOVEL and CAMVM.GOREL.
EXTENCODER.POSMODULO is used as the modulo value for CAMVM.POSITION.

Example

This example shows how CAMVM.POSITION is updated during a CAMVM.GOREL move.

```

CAMVM.FREQ = 10000
CAMVM.RELATIVEDIST = 100000
DRV.TIME = 0
EXTENCODER.POSMODULO = 200000
CAMVM.POSITION = 0
CAMVM.GOREL
While   DRV.TIME < 10000
Print  "DRV.TIME=" ; DRV.TIME , "CAMVM.POSITION=" ; CAMVM.POSITION ,
"CAMVM.MOVING=" ; CAMVM.MOVING
Pause (1)
Wend

```

Related Topics

CAMVM.GOREL (pg 222) | CAMVM.GOVEL (pg 224) | CAMVM.MOVING (pg 225) | FB2.ENCRESES (pg 451)

7.7.15 CAMVM.RELATIVEDIST

General Information	
Type	R/W
Description	Specifies the number or counts that the virtual encoder (virtual master) will put out during an incremental move (CAMVM.GOREL).
Units	Encoder counts
Range	-2^{63} to $2^{63}-1$
Default Value	0
Data Type	Integer
Start Version	M_01-06-00-000

Description

The "move" is performed based upon the value of CAMVM.FREQ. The value of the virtual encoder counter is in the variable CAMVM.POSITION. The modulo value EXTENCODER.POSMODULO is applied to CAMVM.POSITION as well. You can check whether or not the virtual encoder is moving using the variable CAMVM.MOVING. You can move the virtual encoder (using CAMVM.GOREL or CAMVM.GOVEL) whether or not the drive is enabled or disabled.

Example

This example moves the virtual encoder 100,000 counts at a frequency of 20,000 counts/second. This move will take about 5 seconds.

```
'set up CAMVM.POSITION and virtual move parameters
'-----
CAMVM.POSITION = 0
CAMVM.RUNFREQ = 20000
CAMVM.RELATIVEDIST = 100000
'initiate the move
'-----
DRV.TIME = 0 'set time to zero just for measurement
CAMVM.GOREL
'wait for the move to be complete
'-----
while CAMVM.MOVING = 1 : wend
'print the results
'-----
print "CAMVM.POSITION = ";CAMVM.POSITION
print "time = "; DRV.TIME
```

Related Topics

FB2.ENCREC (pg 451)

7.7.16 CAMVM.STOP

General Information	
Type	Statement
Description	CAMVM.STOP stops the virtual encoder
Units	N/A
Range	N/A
Default Value	N/A
Data Type	N/A
Start Version	M_01-06-00-000

Description

CAMVM.STOP stops the virtual encoder. CAMVM.POSITION stays at its present value.

Program execution continues with the line immediately following CAMVM.STOP as soon as the move is initiated. Program execution does not wait until the move is complete.

Example

Run the virtual encoder forward at 20,000 counts/sec for 5 seconds and then stop.

```
CAMVM.FREQ = 20000
CAMVM.DIR = 0
CAMVM.GOREL
pause (5)
CAMVM.STOP
```

Related Topics

CAMVM.GOREL (pg 222) | CAMVM.GOVEL (pg 224) | FB2.ENCRESES (pg 451)

7.8 CAP Parameters

This section describes the CAP parameters.

7.8.1 CAP0.EDGE, CAP1.EDGE	230
7.8.2 CAP0.EN, CAP1.EN	232
7.8.3 CAP0.EVENT, CAP1.EVENT	233
7.8.4 CAP0.FBSOURCE, CAP1.FBSOURCE	236
7.8.5 CAP0.FILTER, CAP1.FILTER	237
7.8.6 CAP0.MODE, CAP1.MODE	238
7.8.7 CAP0.PLFB, CAP1.PLFB	240
7.8.8 CAP0.PREEDGE, CAP1.PREEDGE	242
7.8.9 CAP0.PREFILTER, CAP1.PREFILTER	244
7.8.10 CAP0.PRESELECT, CAP1.PRESELECT	245
7.8.11 CAP0.STATE, CAP1.STATE	247
7.8.12 CAP0.T, CAP1.T	248
7.8.13 CAP0.TRIGGER, CAP1.TRIGGER	250

7.8.1 CAP0.EDGE, CAP1.EDGE

General Information	
Type	NV Parameter
Description	Selects the capture edge.
Units	N/A
Range	1 to 3
Default Value	1
Data Type	U8
Start Version	M_01-00-00-000

Variants Supported

Variant	Supported
AKD Base	Yes
AKD with Position Indexer	Yes
AKD EtherCAT	Yes
AKD CANopen	Yes
AKD BASIC	Yes
AKD SynqNet	Yes
AKD EtherNet/IP	Yes
AKD Profinet	Yes
AKD sercos [®] III	Yes
AKD-N	Yes
AKD-C	No

Fieldbus Information

Parameter	Fieldbus	Address	Attributes	Signed?
CAP0.EDGE	Profinet	2027	Byte	No
	sercos [®] III		2 Octets	
CAP1.EDGE	Profinet	2040	Byte	
	sercos [®] III		2 Octets	

Fieldbus	Index/Subindex		Is 64 bit?	Attributes	Signed?	Object Start Version
Modbus	54	CAP0.EDGE	No	8 bit	No	M_01-03-00-000
	80	CAP1.EDGE				

Description

The filtered trigger source is monitored for rising edge, falling edge, or both edges. The event mode logic may ignore the precondition edge detection; however, the trigger always uses edge detection.

The precondition logic has an identical feature controlled by CAP0.PREEDGE, CAP1.PREEDGE (pg 242).

Value	Description
0	Reserved

Value	Description
1	Rising edge
2	Falling edge
3	Both edges

Related Topics

CAP0.PREEDGE, CAP1.PREEDGE

7.8.2 CAP0.EN, CAP1.EN

General Information	
Type	NV Parameter
Description	Enables or disables the related capture engine.
Units	N/A
Range	0 to 1
Default Value	0
Data Type	Boolean
Start Version	M_01-00-00-000

Variants Supported

Variant	Supported
AKD Base	Yes
AKD with Position Indexer	Yes
AKD EtherCAT	Yes
AKD CANopen	Yes
AKD BASIC	Yes
AKD SynqNet	Yes
AKD EtherNet/IP	Yes
AKD Profinet	Yes
AKD sercos [®] III	Yes
AKD-N	Yes
AKD-C	No

Fieldbus Information

Paramter	Fieldbus	Address	Attributes	Signed?
CAP0.EN	Profinet	2028	Byte	No
	sercos [®] III		2 Octets	
CAP1.EN	Profinet	2041	Byte	
	sercos [®] III		2 Octets	

Fieldbus	Index/Subindex		Is 64 bit?	Attributes	Signed?	Object Start Version
Modbus	56	CAP0.EN	No	8 bit	No	M_01-03-00-000
	82	CAP1.EN				

Description

This parameter enables or disables the related capture engine. After each successful capture event, this parameter is reset to 0 and must be activated again for the next capture. Also note that CAP0.PLFB, CAP1.PLFB (pg 240) is set to 0 when this parameter is set to 1.

0 = Disable

1 = Enable

7.8.3 CAP0.EVENT, CAP1.EVENT

General Information	
Type	NV Parameter
Description	Controls the precondition logic.
Units	N/A
Range	0 to 3
Default Value	0
Data Type	U8
Start Version	M_01-00-00-000

Variants Supported

Variant	Supported
AKD Base	Yes
AKD with Position Indexer	Yes
AKD EtherCAT	Yes
AKD CANopen	Yes
AKD BASIC	Yes
AKD SynqNet	Yes
AKD EtherNet/IP	Yes
AKD Profinet	Yes
AKD sercos [®] III	Yes
AKD-N	Yes
AKD-C	No

Fieldbus Information

Fieldbus	Index/Subindex	Object Start Version
EtherCAT COE and CANopen CANopen	3460h/5	M_01-00-00-000
	3460h/6	

Paramter	Fieldbus	Address	Attributes	Signed?
CAP0.EVENT	Profinet	2029	Byte	No
	sercos [®] III		2 Octets	
CAP1.EVENT	Profinet	2042	Byte	
	sercos [®] III		2 Octets	

Fieldbus	Index/Subindex	Is 64 bit?	Attributes	Signed?	Object Start Version
Modbus	58	No	8 bit	No	M_01-03-00-000
	84				

Description

The event mode controls use of the precondition logic. If this field is not 0, then the precondition input is selected by CAPx.TRIGGER. If this field is 1, then the precondition edge is selected by the CAPx.PREEDGE. The four event modes are listed below.

Event	Description
0	Precondition settings ignored.
1	Trigger on first trigger event after selected edge on precondition input.
2	Trigger on first trigger event to occur while precondition input is 1
3	Trigger on first trigger event to occur while precondition input is 0.

Example

Event 0

The following diagram shows an example of Event = 0 (trigger on edge, trigger edge = rising). In this mode, the precondition logic is ignored.

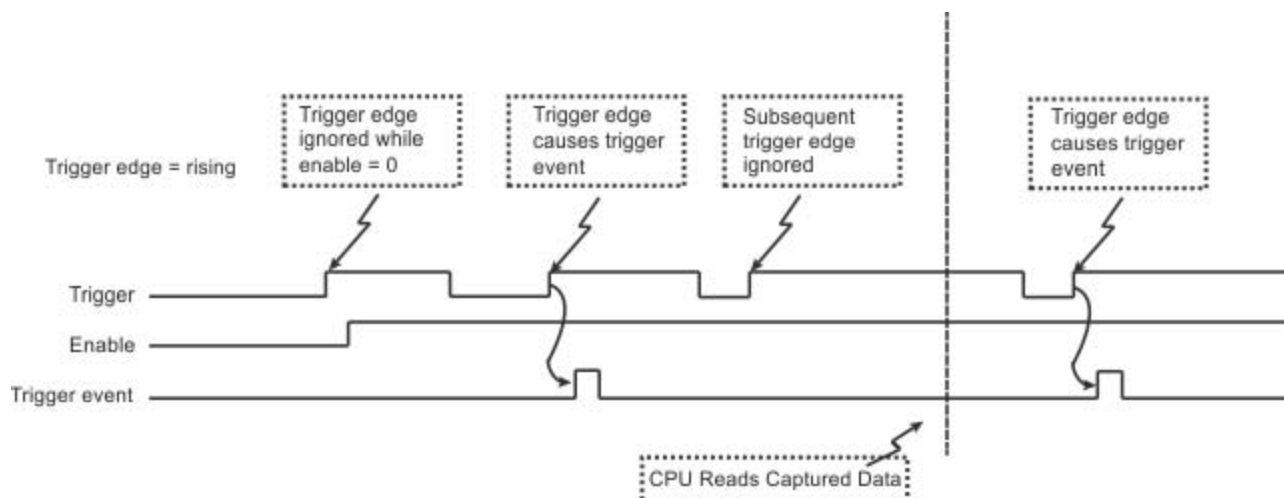

Figure 1: Trigger Edge Mode

Events 2 and 3 (Trigger edge while precondition = 0 or 1)

In these events, the precondition logic samples the current (post-filter) state of the selected precondition source input. The capture engine looks for a trigger edge while the precondition input is at a “1” or “0” state.

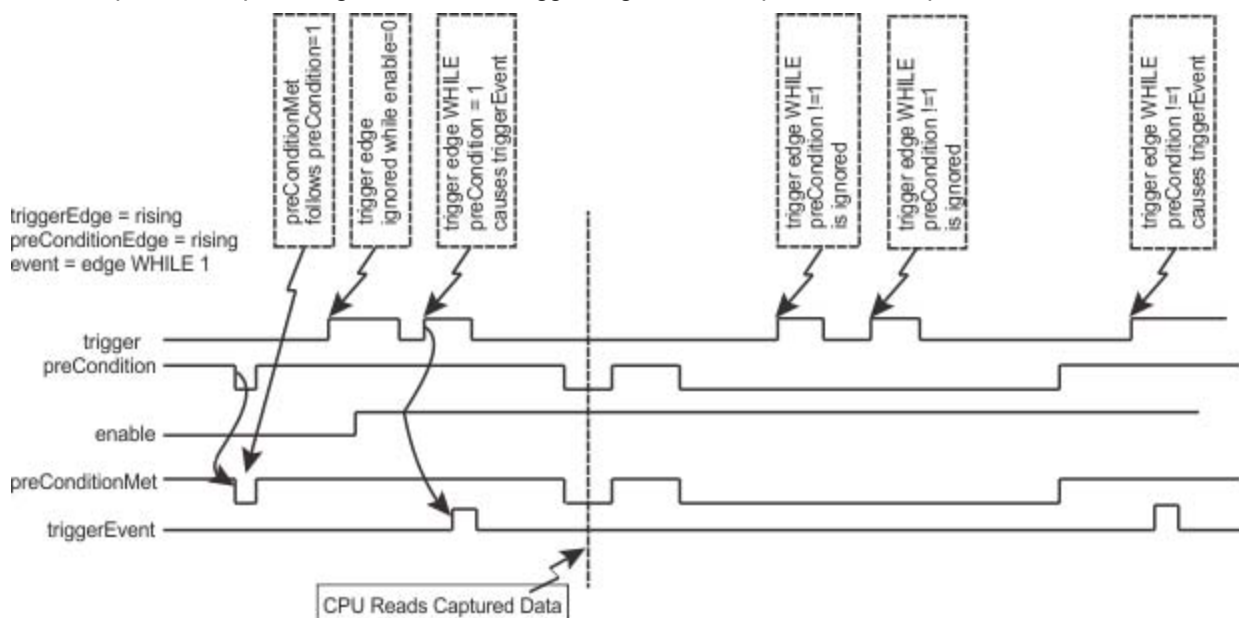

Figure 2: Trigger edge WHILE precondition edge

Event 1 (Trigger edge after precondition)

In this event, each trigger event requires Enable=1, a new precondition edge, followed by a new trigger edge. The sequence requirements are shown in the figure below.

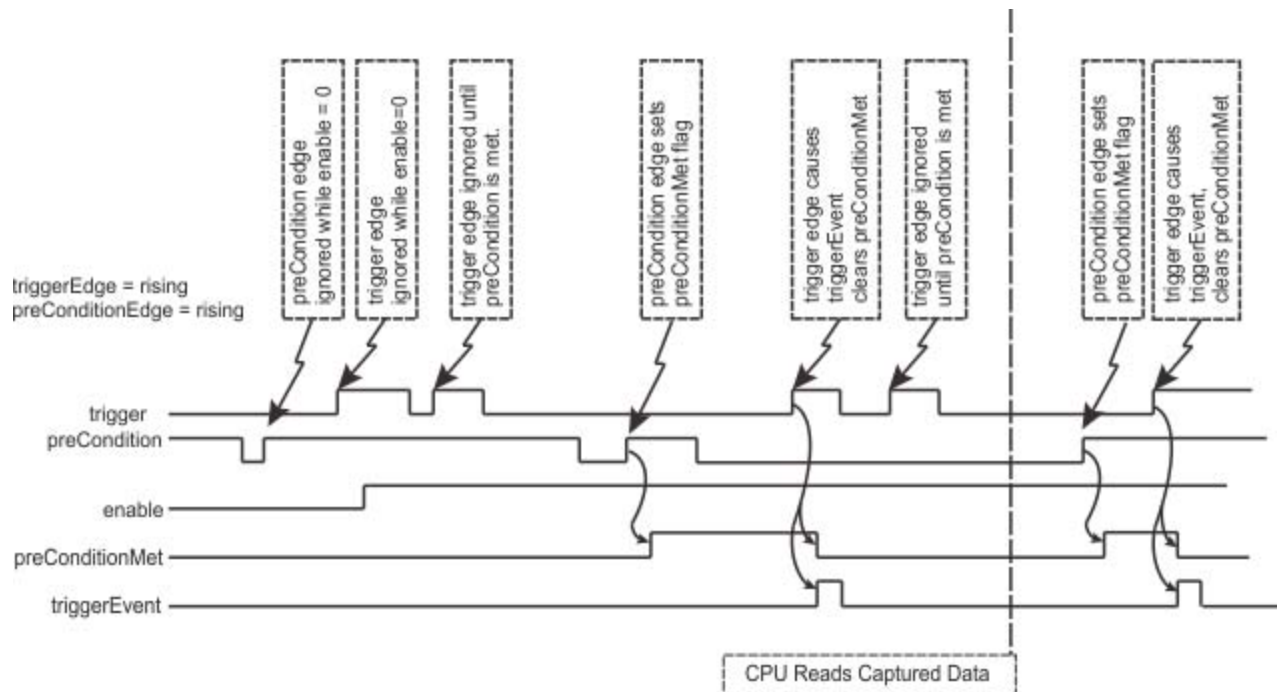

Figure 3: Trigger edge after precondition edge

Note: If the precondition and trigger edges occur at the same time, it is not a valid trigger event. A subsequent trigger edge must occur after the precondition edge. The same time resolves to a single 40 ns clock tick in the trigger event logic (after the optional filter function as well as any sensor, cable, or noise delays).

7.8.4 CAP0.FBSOURCE, CAP1.FBSOURCE

General Information	
Type	NV Parameter
Description	Selects the source of the captured value.
Units	N/A
Range	0 to 4
Default Value	0
Data Type	U8
Start Version	M_01-10-00-000

Variants Supported

Variant	Supported
AKD Base	Yes
AKD with Position Indexer	Yes
AKD EtherCAT	Yes
AKD CANopen	Yes
AKD BASIC	Yes
AKD SynqNet	Yes
AKD EtherNet/IP	Yes
AKD Profinet	Yes
AKD sercos [®] III	Yes
AKD-N	Yes
AKD-C	No

Fieldbus Information

Parameter	Fieldbus	Address	Attributes	Signed?
CAP0.FBSOURCE	Profinet	2883	Byte	No
	sercos [®] III		2 Octets	
CAP1.FBSOURCE	Profinet	2884	Byte	
	sercos [®] III		2 Octets	

Description

CAP0.FBSOURCE and CAP1.FBSOURCE select the source of the captured value. Data for all source values is retrieved with CAP0.PLFB, CAP1.PLFB (pg 240).

Value	Description
0	Captures from feedback 1 (FB1), independent of the value of PL.FBSOURCE. The units are the same as those used for PL.FB.
1	Captures from feedback 2 (FB2).
2	Captures from feedback 3 (FB3).
3	Standard position capture, which stores PL.FB (pg 621). The feedback number is determined by PL.FBSOURCE (pg 623).
4	Captures from EXTENCODER.POSITION (pg 404) (AKD BASIC drives only).

7.8.5 CAP0.FILTER, CAP1.FILTER

General Information	
Type	R/W Parameter
Description	Sets the filter for the capture source input.
Units	N/A
Range	0 to 2
Default Value	0
Data Type	U8
Start Version	M_01-00-00-000
End Version	M_01-03-00-000

Variants Supported

Variant	Supported
AKD Base	Yes
AKD with Position Indexer	Yes
AKD EtherCAT	Yes
AKD CANopen	Yes
AKD BASIC	Yes
AKD SynqNet	Yes
AKD EtherNet/IP	Yes
AKD Profinet	Yes
AKD sercos [®] III	Yes
AKD-N	Yes
AKD-C	No

Fieldbus Information

Paramter	Fieldbus	Address	Attributes	Signed?
CAP0.FILTER	Profinet	2030	Byte	No
	sercos [®] III		2 Octets	
CAP1.FILTER	Profinet	2043	Byte	
	sercos [®] III		2 Octets	

Fieldbus	Index/Subindex		Is 64 bit?	Attributes	Signed?	Object Start Version
Modbus	60	CAP0.FILTER	No	8 bit	No	M_01-03-00-000
	86	CAP1.FILTER				

Description

These parameters are not functional in M_01-03-00-000. In future releases, you can use DINx.FILTER to select a filter on the input channel.

Related Topics

DIN1.FILTER TO DIN7.FILTER (pg 268)

7.8.6 CAP0.MODE, CAP1.MODE

General Information	
Type	NV Parameter
Description	Selects the captured value.
Units	N/A
Range	0 to 4
Default Value	0
Data Type	U8
Start Version	M_01-00-00-000

Variants Supported

Variant	Supported
AKD Base	Yes
AKD with Position Indexer	Yes
AKD EtherCAT	Yes
AKD CANopen	Yes
AKD BASIC	Yes
AKD SynqNet	Yes
AKD EtherNet/IP	Yes
AKD Profinet	Yes
AKD sercos [®] III	Yes
AKD-N	Yes
AKD-C	No

Fieldbus Information

Fieldbus	Index/Subindex	Object Start Version
EtherCAT COE and CANopen CANopen	3460h/3	M_01-00-00-000
	3460h/4	

Parameter	Fieldbus	Address	Attributes	Signed?
CAP0.MODE	Profinet	2031	Byte	No
	sercos [®] III		2 Octets	
CAP1.MODE	Profinet	2044	Byte	
	sercos [®] III		2 Octets	

Fieldbus	Index/Subindex	Is 64 bit?	Attributes	Signed?	Object Start Version
Modbus	62	No	8 bit	No	M_01-03-00-000
	88				

Description

Mode 0: Standard Position

Mode 0 is the standard position capture. The source of the captured position is determined by CAP0.FBSOURCE, CAP1.FBSOURCE (pg 236). Data can be retrieved with CAP0.PLFB, CAP1.PLFB (pg 240).

Mode 1: Drive Internal Time

Mode 1 is the drive internal time capture. Data can be retrieved with CAP0.T, CAP1.T (pg 248).

Mode 2: Distributed Clock Time

Mode 2 is the KAS EtherCAT distributed clock time (DCT) capture. Instead of using a position value, the DCT is calculated. There is no user parameter to retrieve the captured DCT. Attempting to set Mode = 2 with anything other than an EtherCAT system will result in an invalid parameter error.

Mode 3: Primary Encoder Signal

Mode 3 is the capture of the primary encoder signal. This mode is used to home onto a feedback index. This mode sets the other parameters needed for this mode. These parameters can be changed later, but this is not recommended unless the input source of the index signal varies. Parameters set in this mode are:

- CAPx.TRIGGER 10: index mark of primary encoder
- CAPx.EDGE 1: rising edge
- CAPx.EVENT 0: ignore precondition

Also the capture engine is immediately enabled and is continuously triggered again.

Mode 4: Auto-Armed Position

Mode 4 is similar to Mode 0 (standard position capture), except that the re-enabling of the capture is done automatically. This mode can be used for the registration move.

7.8.7 CAP0.PLFB, CAP1.PLFB

General Information		
Type	R/O Parameter	
Description	Reads captured position value.	
Units	Units depend on units of captured source (CAP0.FBSOURCE, CAP1.FBSOURCE (pg 236)):	
	CAPx.FBSOURCE value	Units
	0 (FB1.P (pg 430))	Units depend on value of FB1.PUNIT (pg 438).
	1 (FB2.P (pg 455))	Units depend on value of FB2.PUNIT (pg 458).
	2 (FB3.P (pg 465))	Units depend on value of FB3.PUNIT (pg 468).
	3 (PL.FB (pg 621))	Units depend on UNIT.PROTARY (pg 718) or UNIT.PLINEAR (pg 716).
4 (EXTENCODER.POSITION (pg 404))	Units same as units for EXTENCODER.POSITION.	
Range	Full range of a signed 64 bit variable	
Default Value	0	
Data Type	S64	
Start Version	M_01-00-00-000	

Variants Supported

Variant	Supported
AKD Base	Yes
AKD with Position Indexer	Yes
AKD EtherCAT	Yes
AKD CANopen	Yes
AKD BASIC	Yes
AKD SynqNet	Yes
AKD EtherNet/IP	Yes
AKD Profinet	Yes
AKD sercos [®] III	Yes
AKD-N	Yes
AKD-C	No

Fieldbus Information

Fieldbus	Index/Subindex		Object Start Version
EtherCAT COE and CANopen CANopen	20A0h/0	CAP0.PLFB	M_01-00-00-000
	20A1h/0	CAP0.PLFB	
	20A2h/0	CAP1.PLFB	
	20A3h/0	CAP1.PLFB	

Paramter	Fieldbus	Address	Attributes	Signed?
CAP0.PLFB	Profinet	2032	DWord	Yes
	sercos [®] III		8 Octets	
CAP1.PLFB	Profinet	2045	DWord	
	sercos [®] III		8 Octets	

Fieldbus	Index/Subindex		Is 64 bit?	Attributes	Signed?	Object Start Version
Modbus	64	CAP0.PLFB	Yes	64 bit	Yes	M_01-03-00-000
	90	CAP1.PLFB				

Description

This parameter reads the captured position value scaled to actual set units.

7.8.8 CAP0.PREEDGE, CAP1.PREEDGE

General Information	
Type	NV Parameter
Description	Selects the capture precondition edge.
Units	N/A
Range	1 to 3
Default Value	1
Data Type	U8
Start Version	M_01-00-00-000

Variants Supported

Variant	Supported
AKD Base	Yes
AKD with Position Indexer	Yes
AKD EtherCAT	Yes
AKD CANopen	Yes
AKD BASIC	Yes
AKD SynqNet	Yes
AKD EtherNet/IP	Yes
AKD Profinet	Yes
AKD sercos [®] III	Yes
AKD-N	Yes
AKD-C	No

Fieldbus Information

Fieldbus	Index/Subindex		Object Start Version
EtherCAT COE and CANopen CANopen	3460h/7	CAP0.PREEDGE	M_01-00-00-000
	3460h/8	CAP1.PREEDGE	

Parameter	Fieldbus	Address	Attributes	Signed?
CAP0.PREEDGE	Profinet	2034	Byte	No
	sercos [®] III		2 Octets	
CAP1.PREEDGE	Profinet	2047	Byte	
	sercos [®] III		2 Octets	

Fieldbus	Index/Subindex		Is 64 bit?	Attributes	Signed?	Object Start Version
Modbus	68	CAP0.PREEDGE	No	8 bit	No	M_01-03-00-000
	94	CAP1.PREEDGE				

Description

The precondition edge is monitored for rising edge, falling edge, or both. The event mode logic may ignore the precondition edge detection (trigger always uses edge detection).

The filtered trigger source has an identical feature controlled by CAP0.EDGE, CAP1.EDGE (pg 230).

Value	Description
0	Reserved
1	Rising edge
2	Falling edge
3	Both edges

7.8.9 CAP0.PREFILTER, CAP1.PREFILTER

General Information	
Type	NV Parameter
Description	Sets the filter for the precondition input source.
Units	N/A
Range	0 to 2
Default Value	0
Data Type	U8
Start Version	M_01-00-00-000
End Version	M_01-03-00-000

Variants Supported

Variant	Supported
AKD Base	Yes
AKD with Position Indexer	Yes
AKD EtherCAT	Yes
AKD CANopen	Yes
AKD BASIC	Yes
AKD SynqNet	Yes
AKD EtherNet/IP	Yes
AKD Profinet	Yes
AKD sercos [®] III	Yes
AKD-N	Yes
AKD-C	No

Fieldbus Information

Parameter	Fieldbus	Address	Attributes	Signed?
CAP0.PREFILTER	Profinet	2035	Byte	No
	sercos [®] III		2 Octets	
CAP1.PREFILTER	Profinet	2048	Byte	
	sercos [®] III		2 Octets	

Fieldbus	Index/Subindex		Is 64 bit?	Attributes	Signed?	Object Start Version
Modbus	70	CAP0.PREFILTER	No	8 bit	No	M_01-03-00-000
	96	CAP1.PREFILTER				

Description

These parameters are not functional in M_01-03-00-000. In future releases, you can use DINx.FILTER to select a filter on the input channel.

Related Topics

DIN1.FILTER TO DIN7.FILTER (pg 268)

7.8.10 CAP0.PRESELECT, CAP1.PRESELECT

General Information	
Type	NVParameter
Description	Sets the precondition trigger.
Units	N/A
Range	0 to 10
Default Value	0
Data Type	U8
Start Version	M_01-00-00-000

Variants Supported

Variant	Supported
AKD Base	Yes
AKD with Position Indexer	Yes
AKD EtherCAT	Yes
AKD CANopen	Yes
AKD BASIC	Yes
AKD SynqNet	Yes
AKD EtherNet/IP	Yes
AKD Profinet	Yes
AKD sercos [®] III	Yes
AKD-N	Yes
AKD-C	No

Fieldbus Information

Fieldbus	Index/Subindex		Object Start Version
EtherCAT COE and CANopen CANopen	3460h/9	CAP0.PRESELECT	M_01-00-00-000
	3460h/10	CAP1.PRESELECT	

Paramter	Fieldbus	Address	Attributes	Signed?
CAP0.PRESELECT	Profinet	2036	Byte	No
	sercos [®] III		2 Octets	
CAP1.PRESELECT	Profinet	2049	Byte	
	sercos [®] III		2 Octets	

Fieldbus	Index/Subindex		Is 64 bit?	Attributes	Signed?	Object Start Version
Modbus	72	CAP0.PRESELECT	No	8 bit	No	M_01-03-00-000
	98	CAP1.PRESELECT				

Description

This parameter specifies the input signal for the precondition trigger.

Trigger Source	Input Name
0	General Input 1 (X7)

Trigger Source	Input Name
1	General Input 2 (X7)
2	General Input 3 (X7)
3	General Input 4 (X7)
4	General Input 5 (X8)
5	General Input 6 (X7)
6	General Input 7 (X7)
7	RS485 Input 1 (X9)
8	RS485 Input 2 (X9)
9	RS485 Input 3 (X9)
10	Primary Index

Related Topics

CAP0.TRIGGER, CAP1.TRIGGER (pg 250)

7.8.11 CAP0.STATE, CAP1.STATE

General Information	
Type	R/O Parameter
Description	Indicates whether or not trigger source was captured.
Units	N/A
Range	0 to 1
Default Value	0
Data Type	Integer
Start Version	M_01-00-00-000

Variants Supported

Variant	Supported
AKD Base	Yes
AKD with Position Indexer	Yes
AKD EtherCAT	Yes
AKD CANopen	Yes
AKD BASIC	Yes
AKD SynqNet	Yes
AKD EtherNet/IP	Yes
AKD Profinet	Yes
AKD sercos [®] III	Yes
AKD-N	Yes
AKD-C	No

Fieldbus Information

Parameter	Fieldbus	Address	Attributes	Signed?
CAP0.STATE	Profinet	2037	Byte	No
	sercos [®] III		2 Octets	
CAP1.STATE	Profinet	2050	Byte	
	sercos [®] III		2 Octets	

Fieldbus	Index/Subindex	Is 64 bit?	Attributes	Signed?	Object Start Version
Modbus	74	No	8 bit	No	M_01-03-00-000
	100				

Description

When enabling the capture (CAP0.EN, CAP1.EN (pg 232)), this parameter is set to 0 until the next event is captured.

0 = Not captured or Capture Disabled

1 = Captured

7.8.12 CAP0.T, CAP1.T

General Information	
Type	R/O Parameter
Description	Reads time capture (if time capture was configured).
Units	ns
Range	N/A
Default Value	N/A
Data Type	U32
Start Version	M_01-00-00-000

Variants Supported

Variant	Supported
AKD Base	Yes
AKD with Position Indexer	Yes
AKD EtherCAT	Yes
AKD CANopen	Yes
AKD BASIC	Yes
AKD SynqNet	Yes
AKD EtherNet/IP	Yes
AKD Profinet	Yes
AKD sercos [®] III	Yes
AKD-N	Yes
AKD-C	No

Fieldbus Information

Parameter	Fieldbus	Address	Attributes	Signed?
CAP0.T	Profinet	2038	DWord	No
	sercos [®] III		4 Octets	
CAP1.T	Profinet	2051	DWord	
	sercos [®] III		4 Octets	

Fieldbus	Index/Subindex	Object Start Version
EtherCAT COE and CANopen CANopen	20A0h/0	CAP0.T
	20A0h/0	CAP0.T
	20A2h/0	CAP1.T
	20A3h/0	CAP1.T
		M_01-00-00-000

Fieldbus	Index/Subindex	Is 64 bit?	Attributes	Signed?	Object Start Version
Modbus	76	No	32 bit	No	M_01-03-00-000
	102				

Description

If time capture was configured, the captured time is stored in this parameter. The reference time is the occurrence of the last MTS signal (recurring every 62.5 μs), so this is a purely drive internal time.

Related Topics

CAP0.MODE, CAP1.MODE (pg 238)

7.8.13 CAP0.TRIGGER, CAP1.TRIGGER

General Information	
Type	NV Parameter
Description	Specifies the trigger source for the position capture.
Units	N/A
Range	0 to 11
Default Value	0
Data Type	U8
Start Version	M_01-00-00-000

Variants Supported

Variant	Supported
AKD Base	Yes
AKD with Position Indexer	Yes
AKD EtherCAT	Yes
AKD CANopen	Yes
AKD BASIC	Yes
AKD SynqNet	Yes
AKD EtherNet/IP	Yes
AKD Profinet	Yes
AKD sercos [®] III	Yes
AKD-N	Yes
AKD-C	No

Fieldbus Information

Fieldbus	Index/Subindex	Object Start Version
EtherCAT COE and CANopen CANopen	3460h/1	CAP0.TRIGGER CAP1.TRIGGER
	3460h/2	
		M_01-00-00-000

Parameter	Fieldbus	Address	Attributes	Signed?
CAP0.TRIGGER	Profinet	2039	Byte	No
	sercos [®] III		2 Octets	
CAP1.TRIGGER	Profinet	2052	Byte	
	sercos [®] III		2 Octets	

Fieldbus	Index/Subindex	Is 64 bit?	Attributes	Signed?	Object Start Version
Modbus	78	No	8 bit	No	M_01-03-00-000
	104				

Description

This parameter specifies the trigger source (capture input signal).

Trigger Source	Input Name
0	General Input 1

Trigger Source	Input Name
1	General Input 2
2	General Input 3
3	General Input 4
4	General Input 5
5	General Input 6
6	General Input 7
7	X9 Connector, RS485 Input 1 Pin
8	X9 Connector, RS485 Input 2 Pin
9	X9 Connector, RS485 Input 3 Pin
10	Primary Index
11	Tertiary Index

Related Topics

CAP0.PRESELECT, CAP1.PRESELECT (pg 245)

7.9 CS Parameters

Controlled stop (CS) parameters set the values for the controlled stop process.

7.9.1 CS.DEC	253
7.9.2 CS.STATE	255
7.9.3 CS.TO	256
7.9.4 CS.VTHRESH	258

7.9.1 CS.DEC

General Information	
Type	NV Parameter
Description	Sets the deceleration value for the controlled stop process.
Units	Depends on UNIT.ACCROTARY (pg 713) or UNIT.ACCLINEAR (pg 712) Rotary: rps/s, rpm/s, deg/s ² , (Custom Units)/s ² , rad/s ² Linear: counts/s ² , mm/s ² , μm/s ² , (Custom Units)/s ²
Range	Rotary: 0.002 to 833,333.333 rps/s 0.112 to 50,000,000.000 rpm/s 0.009 to 300,000,000.000 deg/s ² 0.155 to 4,166,666.752 (Custom Units)/s ² 0.012 to 5,235,987.968 rad/s ² Linear: 16,000.000 to 3,579,139,408,000.000 counts/s ² 0.031*MOTOR.PITCH (pg 570) to 833333.333*MOTOR.PITCH (pg 570) mm/s ² 30.994*MOTOR.PITCH (pg 570) to 833333333.333*MOTOR.PITCH (pg 570) μm/s ² 0.155 to 4,166,666.667 (Custom Units)/s ²
Default Value	Rotary: 166.669 rps/s 10,000.000 rpm/s 60,000.000 deg/s ² 833.333 (Custom Units)/s ² 1,047.2 rad/s ² Linear: 715,840,000.000 counts/s ² 166.714*MOTOR.PITCH (pg 570)MOTOR.PITCH (pg 570) mm/s ² 166,714.191*MOTOR.PITCH (pg 570)MOTOR.PITCH (pg 570) μm/s ² 833.571 (Custom Units)/s ²
Data Type	Float
Start Version	M_01-00-00-000

Variants Supported

Variant	Supported
AKD Base	Yes
AKD with Position Indexer	Yes
AKD EtherCAT	Yes
AKD CANopen	Yes
AKD BASIC	Yes
AKD SynqNet	Yes
AKD EtherNet/IP	Yes
AKD Profinet	Yes
AKD sercos [®] III	Yes
AKD-N	Yes
AKD-C	No

Fieldbus Information

Fieldbus	Index/Subindex	Object Start Version
EtherCAT COE and CANopen CANopen	3440h/1	M_01-00-00-000

Fieldbus	Address	Attributes	Signed?
Profinet	2053	DWord	No
sercos [®] III		8 Octets	

Fieldbus	Index/Subindex	Is 64 bit?	Attributes	Signed?	Object Start Version
Modbus	106	Yes	64 bit	No	M_01-03-00-000

Description

This parameter sets the deceleration value for the controlled stop process.

Related Topics

CS.VTHRESH (pg 258), CS.TO (pg 256), DRV.DIS, DIN1.MODE TO DIN7.MODE (pg 272),
DRV.DISSOURCES (pg 323)

7.9.2 CS.STATE

General Information	
Type	R/O Parameter
Description	Returns the internal status of the controlled stop process.
Units	N/A
Range	N/A
Default Value	N/A
Data Type	N/A
Start Version	M_01-00-00-000

Variants Supported

Variant	Supported
AKD Base	Yes
AKD with Position Indexer	Yes
AKD EtherCAT	Yes
AKD CANopen	Yes
AKD BASIC	Yes
AKD SynqNet	Yes
AKD EtherNet/IP	Yes
AKD Profinet	Yes
AKD sercos [®] III	Yes
AKD-N	Yes
AKD-C	No

Fieldbus Information

Fieldbus	Index/Subindex	Object Start Version
EtherCAT COE and CANopen CANopen	3441h/0	M_01-00-00-000

Fieldbus	Address	Attributes	Signed?
Profinet	2055	Byte	No
sercos [®] III		2 Octets	

Fieldbus	Index/Subindex	Is 64 bit?	Attributes	Signed?	Object Start Version
Modbus	110	No	8 bit	No	M_01-03-00-000

Description

CS.STATE returns the internal state machine value of the controlled stop.

0 = controlled stop is not occurring.

1 = controlled stop is occurring

Related Topics

CS.DEC (pg 253), CS.VTHRESH (pg 258), CS.TO (pg 256) DRV.DISSOURCES (pg 323)

7.9.3 CS.TO

General Information	
Type	NV Parameter
Description	Sets the time value for the drive velocity to be within CS.VTHRESH (pg 258).
Units	ms
Range	1 to 30,000 ms
Default Value	6 ms
Data Type	Integer
Start Version	M_01-00-00-000

Variants Supported

Variant	Supported
AKD Base	Yes
AKD with Position Indexer	Yes
AKD EtherCAT	Yes
AKD CANopen	Yes
AKD BASIC	Yes
AKD SynqNet	Yes
AKD EtherNet/IP	Yes
AKD Profinet	Yes
AKD sercos [®] III	Yes
AKD-N	Yes
AKD-C	No

Fieldbus Information

Fieldbus	Index/Subindex	Object Start Version
EtherCAT COE and CANopen CANopen	3440h/3	M_01-00-00-000

Fieldbus	Address	Attributes	Signed?
Profinet	2056	DWord	No
sercos [®] III		4 Octets	

Fieldbus	Index/Subindex	Is 64 bit?	Attributes	Signed?	Object Start Version
Modbus	112	No	32 bit	No	M_01-03-00-000

Description

CS.TO is the time value for the drive velocity to be within CS.VTHRESH (pg 258) before the drive disables.

Example

Set time value to 100 ms:

```
-->CS.TO 100
```

Related Topics

CS.DEC (pg 253), CS.VTHRESH (pg 258), CS.STATE, DRV.DIS, DIN1.MODE TO DIN7.MODE (pg 272), DRV.DISSOURCES (pg 323)

7.9.4 CS.VTHRESH

General Information	
Type	NV Parameter
Description	Sets the velocity threshold for the controlled stop.
Units	rpm, rps, deg/s, Custom Units/s
Range	Rotary: 0.000 to 15,000.000 rpm 0.000 to 250.000 rps 0.000 to 90,000.000 deg/s 0.000 to 1,250.000 Custom Units/s 0.000 to 1,570.796 rad/s Linear: 0.000 to 1,073,741,824,000.000 counts/s 0.000 to 8,000.000 mm/s 0.000 to 8,000,000.000 µm/s 0.000 to 1,250.000 Custom Units/s
Default Value	5 rpm
Data Type	Float
Start Version	M_01-00-00-000

Variants Supported

Variant	Supported
AKD Base	Yes
AKD with Position Indexer	Yes
AKD EtherCAT	Yes
AKD CANopen	Yes
AKD BASIC	Yes
AKD SynqNet	Yes
AKD EtherNet/IP	Yes
AKD Profinet	Yes
AKD sercos [®] III	Yes
AKD-N	Yes
AKD-C	No

Fieldbus Information

Fieldbus	Index/Subindex	Object Start Version
EtherCAT COE and CANopen CANopen	3440h/2	M_01-00-00-000

Fieldbus	Parameter	Address	Attributes	Signed?
Profinet	CS.VTHRESH_32	2057	DWord	No
sercos [®] III			8 Octets	

Fieldbus	Index/Subindex	Is 64 bit?	Attributes	Signed?	Object Start Version
Modbus	114	Yes	low 32 bit word	No	M_01-03-00-000

Description

CS.VTHRESH is the velocity threshold for the controlled stop algorithm.

Example

Set velocity threshold for controlled stop at 100 rpm:

```
-->CS.VTHRESH 100
```

Related Topics

CS.DEC (pg 253), CS.TO (pg 256), CS.STATE (pg 255), DRV.DIS (pg 320), DIN1.MODE TO DIN7.MODE (pg 272), DRV.DISSOURCES (pg 323)

7.10 DIN Parameters

This section describes the DIN parameters.

7.10.1 DIN.HCMD1 TO DIN.HCMD4	262
7.10.2 DIN.LCMD1 to DIN.LCMD4	264
7.10.3 DIN.ROTARY	265
7.10.4 DIN.STATES	267
7.10.5 DIN1.FILTER TO DIN7.FILTER	268
7.10.6 DIN1.INV to DIN7.INV	270
7.10.7 DIN1.MODE TO DIN7.MODE	272
7.10.8 DIN1.STATE TO DIN7.STATE	274
7.10.9 DIN9.STATE to DIN11.STATE	276
7.10.10 DIN21.FILTER to DIN32.FILTER	277
7.10.11 DIN21.STATE to DIN32.STATE	279

7.10.1 DIN.HCMD1 TO DIN.HCMD4

General Information	
Type	NV parameter
Description	A buffer of commands to be used in digital input "command buffer" mode.
Units	None
Range	A string of up to 128 characters
Default Value	<Empty>
Data Type	String
Start Version	M_01-02-08-000

Variants Supported

Variant	Supported
AKD Base	Yes
AKD with Position Indexer	Yes
AKD EtherCAT	Yes
AKD CANopen	Yes
AKD BASIC	Yes
AKD SynqNet	Yes
AKD EtherNet/IP	Yes
AKD Profinet	Yes
AKD sercos [®] III	Yes
AKD-N	Yes
AKD-C	No

Description

DIN.HCMDx sets the string of commands to be used in the digital input mode command buffer. Digital input mode **9-Command buffer** can execute four different sets of command buffers.

Each set of command buffers contains two buffers:

- High buffer: Executes upon a rising edge of a digital input.
- Low buffer: Executes upon a falling edge of a digital input.

DIN.HCMDx sets the string for the four high buffers (depending on x).

Example

Set the command buffer mode to digital input 1:

```
DIN1.MODE 9
```

Set the first sets of buffers to digital input 1:

```
DIN1.PARAM 1
```

Set the command DRV.OPMODE 0 to the high buffer:

```
DIN.HCMD1 DRV.OPMODE 1
```

Now, upon a rising edge in digital input 1, the drive mode is 1.

Related Topics

DIN1.MODE TO DIN7.MODE (pg 272), DIN1.PARAM TO DIN7.PARAM, DIN.LCMD1 to DIN.LCMD4
(pg 264)

7.10.2 DIN.LCMD1 to DIN.LCMD4

General Information	
Type	NV parameter
Description	A buffer of commands to be used in digital input "command buffer" mode.
Units	N/A
Range	A string of up to 128 characters
Default Value	Empty
Data Type	String
Start Version	M_01-02-08-000

Variants Supported

Variant	Supported
AKD Base	Yes
AKD with Position Indexer	Yes
AKD EtherCAT	Yes
AKD CANopen	Yes
AKD BASIC	Yes
AKD SynqNet	Yes
AKD EtherNet/IP	Yes
AKD Profinet	Yes
AKD sercos [®] III	Yes
AKD-N	Yes
AKD-C	No

Description

DIN.LCMDx sets the string of commands to be used in the digital input mode command buffer. Digital input mode **9-Command buffer** can execute four different sets of command buffers.

Each set of command buffers contains two buffers:

- High buffer: Executes upon a rising edge of a digital input.
- Low buffer: Executes upon a falling edge of a digital input.

DIN.LCMDx sets the string for the four "low" buffers, depending on x.

Example

Set the command buffer mode to digital input 1:

```
DIN1.MODE 9
```

Set the first sets of buffers to digital input 1:

```
DIN1.PARAM 1
```

Set the command DRV.OPMODE 0 to the "low buffer":

```
DIN.LCMD1 DRV.OPMODE 0
```

Now, upon a falling edge in digital input 1, the drive mode is 0.

Related Topics

DIN1.MODE TO DIN7.MODE (pg 272), DIN.HCMD1 TO DIN.HCMD4 (pg 262)

7.10.3 DIN.ROTARY

General Information	
Type	R/O Parameter
Description	Reads the rotary knob value.
Units	N/A
Range	0 to 99
Default Value	N/A
Data Type	Integer
Start Version	M_01-00-00-000

Variants Supported

Variant	Supported
AKD Base	Yes
AKD with Position Indexer	Yes
AKD EtherCAT	Yes
AKD CANopen	Yes
AKD BASIC	Yes
AKD SynqNet	Yes
AKD EtherNet/IP	Yes
AKD Profinet	Yes
AKD sercos [®] III	Yes
AKD-N	Yes
AKD-C	No

Fieldbus Information

Fieldbus	Address	Attributes	Signed?
Profinet	2058	Byte	No
sercos [®] III		2 Octets	

Fieldbus	Index/Subindex	Is 64 bit?	Attributes	Signed?	Object Start Version
Modbus	116	No	8 bit	No	M_01-03-00-000

Description

DIN.ROTARY reads the rotary knob value.



7.10.4 DIN.STATES

General Information	
Type	R/O Parameter
Description	Reads the digital input states.
Units	N/A
Range	0000000 to 1111111
Default Value	N/A
Data Type	String
Start Version	M_01-00-00-000

AKD-N Information	
Range	000 to 111

Variants Supported

Variant	Supported
AKD Base	Yes
AKD with Position Indexer	Yes
AKD EtherCAT	Yes
AKD CANopen	Yes
AKD BASIC	Yes
AKD SynqNet	Yes
AKD EtherNet/IP	Yes
AKD Profinet	Yes
AKD sercos [®] III	Yes
AKD-N	Yes
AKD-C	No

Description

DIN.STATES reads the states of the digital inputs. The leftmost bit represents digital input 1 (DIN1) and the rightmost bit represents digital input 7 (DIN7).

NOTE AKD-N only supports DIN1 to DIN3.

7.10.5 DIN1.FILTER TO DIN7.FILTER

General Information	
Type	R/W Parameter
Description	Filter mode for digital inputs 1 to 7.
Units	N/A
Range	0 to 3
Default Value	1 for DIN1 and DIN2 2 for DIN3 to DIN7
Data Type	Integer
Start Version	M_01-03-07-000

Variants Supported

Variant	Supported
AKD Base	Yes
AKD with Position Indexer	Yes
AKD EtherCAT	Yes
AKD CANopen	Yes
AKD BASIC	Yes
AKD SynqNet	Yes
AKD EtherNet/IP	Yes
AKD Profinet	Yes
AKD sercos [®] III	Yes
AKD-N	Yes
AKD-C	No

Fieldbus Information

Paramter	Fieldbus	Address	Attributes	Signed?
DIN1.FILTER	Profinet	2459	Word	No
	sercos [®] III		2 Octets	
DIN2.FILTER	Profinet	2460	Word	
	sercos [®] III		2 Octets	
DIN3.FILTER	Profinet	2461	Word	
	sercos [®] III		2 Octets	
DIN4.FILTER	Profinet	2462	Word	
	sercos [®] III		2 Octets	
DIN5.FILTER	Profinet	2463	Word	
	sercos [®] III		2 Octets	
DIN6.FILTER	Profinet	2464	Word	
	sercos [®] III		2 Octets	
DIN7.FILTER	Profinet	2465	Word	
	sercos [®] III		2 Octets	

Fieldbus	Index/Subindex		Is 64 bit?	Attributes	Signed?
Modbus	918	DIN1.FILTER	No	16 bit	No
	920	DIN2.FILTER			
	922	DIN3.FILTER			
	924	DIN4.FILTER			
	926	DIN5.FILTER			
	928	DIN6.FILTER			
	930	DIN7.FILTER			

Description

This parameter sets the digital input filter configuration for channel x when followed with the values defined below. DINx.FILTER retrieves this information when not followed by data.

Value	Description
DINX.FILTER 0	The drive digital input channel detects all input signals with an input pulse width of ≥ 40 ns (no filtering applied).
DINX.FILTER 1	The drive digital input channel detects all input signals with an input pulse width of ≥ 10.24 μ s, ± 0.64 μ s (fast filter applied).
DINX.FILTER 2	The drive digital input channel detects all input signals with an input pulse width of ≥ 163 μ s, ± 10.24 μ s (standard filter applied).
DINX.FILTER 3	The drive digital input channel detects all input signals with an input pulse width of ≥ 2.62 ms, ± 0.16384 ms (slow filter applied).

NOTE

AKD-N only supports DIN1 to DIN3.

7.10.6 DIN1.INV to DIN7.INV

General Information	
Type	RW Parameter
Description	Sets the indicated polarity of a digital input mode.
Units	N/A
Range	0 to 1
Default Value	0
Data Type	Boolean
Start Version	M_01-00-00-000

Variants Supported

Variant	Supported
AKD Base	Yes
AKD with Position Indexer	Yes
AKD EtherCAT	Yes
AKD CANopen	Yes
AKD BASIC	Yes
AKD SynqNet	Yes
AKD EtherNet/IP	Yes
AKD Profinet	Yes
AKD sercos [®] III	Yes
AKD-N	Yes
AKD-C	No

Fieldbus Information

Paramter	Fieldbus	Address	Attributes	Signed?
DIN1.INV	Profinet	2060	Byte	No
	sercos [®] III		2 Octets	
DIN2.INV	Profinet	2065	Byte	
	sercos [®] III		2 Octets	
DIN3.INV	Profinet	2070	Byte	
	sercos [®] III		2 Octets	
DIN4.INV	Profinet	2075	Byte	
	sercos [®] III		2 Octets	
DIN5.INV	Profinet	2080	Byte	
	sercos [®] III		2 Octets	
DIN6.INV	Profinet	2085	Byte	
	sercos [®] III		2 Octets	
DIN7.INV	Profinet	2090	Byte	
	sercos [®] III		2 Octets	

Fieldbus	Index/Subindex	Is 64 bit?	Attributes	Signed?	Object Start Version	
Modbus	120	DIN1.INV	No	8 bit	No	M_01-03-00-000
	130	DIN2.INV				
	140	DIN3.INV				
	150	DIN4.INV				
	160	DIN5.INV				
	170	DIN6.INV				
	180	DIN7.INV				

Description

Sets the indicated polarity of a digital input mode.

NOTE AKD-N only supports DIN1 to DIN3.

Example

DIN1.INV = 0 : Input is active high.

DIN1.INV = 1 : Input is active low.

7.10.7 DIN1.MODE TO DIN7.MODE

General Information	
Type	R/W Parameter
Description	Sets the digital input modes.
Units	N/A
Range	0 to 26
Default Value	0
Data Type	Integer
Start Version	M_01-00-00-000

AKD SynqNet Information	
Range	0

AKD BASIC Information	
Range	0, 1, 13, 18, 19

Variants Supported

Variant	Supported
AKD Base	Yes
AKD with Position Indexer	Yes
AKD EtherCAT	Yes
AKD CANopen	Yes
AKD BASIC	Yes
AKD SynqNet	Yes
AKD EtherNet/IP	Yes
AKD Profinet	Yes
AKD sercos [®] III	Yes
AKD-N	Yes
AKD-C	No

Fieldbus Information

Fieldbus	Index/Subindex		Object Start Version
EtherCAT COE and CANopen CANopen	3562h/0	DIN1.MODE	M_01-00-00-000
	3565h/0	DIN2.MODE	
	3568h/0	DIN3.MODE	
	356Bh/0	DIN4.MODE	
	36F6h/0	DIN5.MODE	
	36F9h/0	DIN6.MODE	
	36FCh/0	DIN7.MODE	
	60FDh/0	DIN1.MODE TO DIN7.MODE	

Paramter	Fieldbus	Address	Attributes	Signed?
DIN1.MODE	Profinet	2061	Byte	No
	sercos [®] III		2 Octets	
DIN2.MODE	Profinet	2066	Byte	
	sercos [®] III		2 Octets	
DIN3.MODE	Profinet	2071	Byte	
	sercos [®] III		2 Octets	
DIN4.MODE	Profinet	2076	Byte	
	sercos [®] III		2 Octets	
DIN5.MODE	Profinet	2081	Byte	
	sercos [®] III		2 Octets	
DIN6.MODE	Profinet	2086	Byte	
	sercos [®] III		2 Octets	
DIN7.MODE	Profinet	2091	Byte	
	sercos [®] III		2 Octets	

Fieldbus	Index/Subindex		Is 64 bit?	Attributes	Signed?	Object Start Version
Modbus	122	DIN1.MODE	No	16 bit	No	M_01-03-00-000
	132	DIN2.MODE				
	142	DIN3.MODE				
	152	DIN4.MODE				
	162	DIN5.MODE				
	172	DIN6.MODE				
	182	DIN7.MODE				

Description

This parameter sets the functionality of the digital inputs. Digital inputs and corresponding X7 and X8 pin connectors are described in the *AKD Installation Manual*, section 8.16.4, Digital Inputs. The table below summarizes the digital input modes.

NOTE AKD-N only supports DIN1 to DIN3.

DINx.MODE	Description	Task
0	No function; off	None
1	Fault reset	Background
7	Reserved	None
12	Reserved	None
13	Controlled Stop	1 kHz
14	Reserved	None
18	Positive limit switch	4 kHz
19	Negative limit switch	4kHz

7.10.8 DIN1.STATE TO DIN7.STATE

General Information	
Type	R/O Parameter
Description	Reads a specific digital input state.
Units	N/A
Range	0 to 1
Default Value	N/A
Data Type	Integer
Start Version	M_01-00-00-000

Variants Supported

Variant	Supported
AKD Base	Yes
AKD with Position Indexer	Yes
AKD EtherCAT	Yes
AKD CANopen	Yes
AKD BASIC	Yes
AKD SynqNet	Yes
AKD EtherNet/IP	Yes
AKD Profinet	Yes
AKD sercos [®] III	Yes
AKD-N	Yes
AKD-C	No

Fieldbus Information

Paramter	Fieldbus	Address	Attributes	Signed?
DIN1.STATE	Profinet	2064	Byte	No
	sercos [®] III		2 Octets	
DIN2.STATE	Profinet	2069	Byte	
	sercos [®] III		2 Octets	
DIN3.STATE	Profinet	2074	Byte	
	sercos [®] III		2 Octets	
DIN4.STATE	Profinet	2079	Byte	
	sercos [®] III		2 Octets	
DIN5.STATE	Profinet	2084	Byte	
	sercos [®] III		2 Octets	
DIN6.STATE	Profinet	2089	Byte	
	sercos [®] III		2 Octets	
DIN7.STATE	Profinet	2094	Byte	
	sercos [®] III		2 Octets	

Fieldbus	Index/Subindex		Is 64 bit?	Attributes	Signed?	Object Start Version
Modbus	128	DIN1.STATE	No	8 bit	No	M_01-03-00-000
	138	DIN2.STATE				
	148	DIN3.STATE				
	158	DIN4.STATE				
	168	DIN5.STATE				
	178	DIN6.STATE				
	188	DIN7.STATE				

Description

Reads the state of one digital input according to the number identified in the command.

NOTE

AKD-N only supports DIN1 to DIN3.

7.10.9 DIN9.STATE to DIN11.STATE

General Information	
Type	NV Parameter
Description	Shows on selected pin if signal is high or low.
Units	N/A
Range	0 to 1
Default Value	0
Data Type	U8
Start Version	M_01-05-00-000

Variants Supported

Variant	Supported
AKD Base	Yes
AKD with Position Indexer	Yes
AKD EtherCAT	Yes
AKD CANopen	Yes
AKD BASIC	Yes
AKD SynqNet	Yes
AKD EtherNet/IP	Yes
AKD Profinet	Yes
AKD sercos [®] III	Yes
AKD-N	No
AKD-C	No

Fieldbus Information

Parameter	Fieldbus	Address	Attributes	Signed?
DIN9.STATE	Profinet	2727	Byte	No
	sercos [®] III		2 Octets	
DIN10.STATE	Profinet	2653	Byte	
	sercos [®] III		2 Octets	
DIN11.STATE	Profinet	2654	Byte	
	sercos [®] III		2 Octets	

Fieldbus	Index/Subindex	Is 64 bit?	Attributes	Signed?	Object Start Version	
Modbus	1454	DIN9.STATE	No	8 bit	No	M_01-06-03-000
	1306	DIN10.STATE				
	1308	DIN11.STATE				

Description

This parameter allows the user to see the actual level of the input signal, when the IO is set to input mode. Parameter value is 0 if signal is low and 1 if signal is high. DIOx.INV can affect the value in this register.

This parameter can be read at any time. The value is only guaranteed to correspond to the output on the X9 connector when DRV.EMUEMODE is set to 10 and the DIOX.DIR is 0.

7.10.10 DIN21.FILTER to DIN32.FILTER

General Information	
Type	R/W Parameter
Description	Filter mode for digital inputs 21 to 32.
Units	N/A
Range	0 to 3
Default Value	2
Data Type	Integer
Start Version	M_01-03-07-000

Variants Supported

Supported by any AKD with extended IO.

Fieldbus Information

Parameter	Fieldbus	Address	Attributes	Signed?
DIN21.FILTER	Profinet	2655	Word	No
	sercos [®] III		2 Octets	
DIN22.FILTER	Profinet	2661	Word	
	sercos [®] III		2 Octets	
DIN23.FILTER	Profinet	2667	Word	
	sercos [®] III		2 Octets	
DIN24.FILTER	Profinet	2673	Word	
	sercos [®] III		2 Octets	
DIN25.FILTER	Profinet	2679	Word	
	sercos [®] III		2 Octets	
DIN26.FILTER	Profinet	2685	Word	
	sercos [®] III		2 Octets	
DIN27.FILTER	Profinet	2691	Word	
	sercos [®] III		2 Octets	
DIN28.FILTER	Profinet	2697	Word	
	sercos [®] III		2 Octets	
DIN29.FILTER	Profinet	2703	Word	
	sercos [®] III		2 Octets	
DIN30.FILTER	Profinet	2709	Word	
	sercos [®] III		2 Octets	
DIN31.FILTER	Profinet	2715	Word	
	sercos [®] III		2 Octets	
DIN32.FILTER	Profinet	2721	Word	
	sercos [®] III		2 Octets	

Fieldbus	Index/Subindex	Is 64 bit?	Attributes	Signed?	
Modbus	1310	DIN21.FILTER	No	16 bit	No
	1322	DIN22.FILTER			
	1334	DIN23.FILTER			
	1346	DIN24.FILTER			
	1358	DIN25.FILTER			
	1370	DIN26.FILTER			
	1382	DIN27.FILTER			
	1394	DIN28.FILTER			
	1406	DIN29.FILTER			
	1418	DIN30.FILTER			
	1430	DIN31.FILTER			
	1442	DIN32.FILTER			

Description

This parameter sets the digital input filter configuration for channel x when followed with the values defined below. DINx.FILTER retrieves this information when not followed by data.

Value	Description
DINX.FILTER 0	The drive digital input channel detects all input signals with an input pulse width of ≥ 40 ns (no filtering applied).
DINX.FILTER 1	The drive digital input channel detects all input signals with an input pulse width of ≥ 10.24 μ s, ± 0.64 μ s (fast filter applied).
DINX.FILTER 2	The drive digital input channel detects all input signals with an input pulse width of ≥ 163 μ s, ± 10.24 μ s (standard filter applied).
DINX.FILTER 3	The drive digital input channel detects all input signals with an input pulse width of ≥ 2.62 ms, ± 0.16384 ms (slow filter applied).

7.10.11 DIN21.STATE to DIN32.STATE

General Information	
Type	R/O Parameter
Description	Reads a specific digital input state.
Units	N/A
Range	0 to 1
Default Value	N/A
Data Type	Integer
Start Version	M_01-00-00-000

Variants Supported

Supported by any AKD with extended IO.

Fieldbus Information

Parameter	Fieldbus	Address	Attributes	Signed?
DIN21.STATE	Profinet	2660	Byte	No
	sercos [®] III		2 Octets	
DIN22.STATE	Profinet	2666	Byte	
	sercos [®] III		2 Octets	
DIN23.STATE	Profinet	2672	Byte	
	sercos [®] III		2 Octets	
DIN24.STATE	Profinet	2678	Byte	
	sercos [®] III		2 Octets	
DIN25.STATE	Profinet	2684	Byte	
	sercos [®] III		2 Octets	
DIN26.STATE	Profinet	2690	Byte	
	sercos [®] III		2 Octets	
DIN27.STATE	Profinet	2696	Byte	
	sercos [®] III		2 Octets	
DIN28.STATE	Profinet	2702	Byte	
	sercos [®] III		2 Octets	
DIN29.STATE	Profinet	2708	Byte	
	sercos [®] III		2 Octets	
DIN30.STATE	Profinet	2714	Byte	
	sercos [®] III		2 Octets	
DIN31.STATE	Profinet	2720	Byte	
	sercos [®] III		2 Octets	
DIN32.STATE	Profinet	2726	Byte	
	sercos [®] III		2 Octets	

Fieldbus	Index/Subindex	Is 64 bit?	Attributes	Signed?	
Modbus	1320	DIN21.STATE	No	8 bit	No
	1332	DIN22.STATE			
	1344	DIN23.STATE			
	1356	DIN24.STATE			
	1368	DIN25.STATE			
	1380	DIN26.STATE			
	1392	DIN27.STATE			
	1404	DIN28.STATE			
	1416	DIN29.STATE			
	1428	DIN30.STATE			
	1440	DIN31.STATE			
	1452	DIN32.STATE			

Description

DIN21.STATE to DIN32.STATE reads the state of one digital input according to the number identified in the command.

7.11 DIO Parameters

This section describes the DIO parameters.

7.11.1 DIO9.DIR to DIO11.DIR	282
7.11.2 DIO9.INV to DIO11.INV	283

7.11.1 DIO9.DIR to DIO11.DIR

General Information	
Type	NV Parameter
Description	Changing direction of the IOs from the X9 connector.
Units	N/A
Range	0 to 1
Default Value	0
Data Type	U8
Start Version	M_01-05-00-000

Variants Supported

Variant	Supported
AKD Base	Yes
AKD with Position Indexer	Yes
AKD EtherCAT	Yes
AKD CANopen	Yes
AKD BASIC	Yes
AKD SynqNet	Yes
AKD EtherNet/IP	Yes
AKD Profinet	Yes
AKD sercos [®] III	Yes
AKD-N	No
AKD-C	No

Fieldbus Information

Fieldbus	Index/Subindex	Is 64 bit?	Attributes	Signed?	
Modbus	1190	DIO10.DIR	No	8 bit	No
	1194	DIO11.DIR			
	1198	DIO9.DIR			

Description

This parameter changes the direction of the general purpose IO from the X9 connector. If DIOx.DIR is set 0 then the IO configured as an input, while if DIOx.DIR is 1 the IO is configured as an output.

DIO9.DIR controls pins 1 and 2

DIO10.DIR controls pins pin 4 and 5

DIO11.DIR controls pins pin 7 and 8.

This parameter can be set at any time. It will be ignored unless DRV.EMUEMODE is set to 10.

7.11.2 DIO9.INV to DIO11.INV

General Information	
Type	NV Parameter
Description	Inverting the output voltage of the IO, when in the output direction.
Units	NA
Range	0 to 1
Default Value	0
Data Type	U8
Start Version	M_01-05-00-000

Variants Supported

Variant	Supported
AKD Base	Yes
AKD with Position Indexer	Yes
AKD EtherCAT	Yes
AKD CANopen	Yes
AKD BASIC	Yes
AKD SynqNet	Yes
AKD EtherNet/IP	Yes
AKD Profinet	Yes
AKD sercos [®] III	Yes
AKD-N	No
AKD-C	No

Fieldbus Information

Parameter	Fieldbus	Address	Attributes	Signed?
DIO9.INV	Profinet	2600	Byte	No
	sercos [®] III		2 Octets	
DIO10.INV	Profinet	2596	Byte	
	sercos [®] III		2 Octets	
DIO11.INV	Profinet	2598	Byte	
	sercos [®] III		2 Octets	

Fieldbus	Index/Subindex	Is 64 bit?	Attributes	Signed?	
Modbus	1192	DIO10.INV	No	8 bit	No
	1196	DIO11.INV			
	1200	DIO9.INV			

Description

This parameter changes the logic sense of the differential input/output signals. When false, a logic 1 occurs when the + signal is higher than the – signal. When true, a logic 1 occurs when the – signal is higher than the + signal.

The drive output parameters DOUTx.STATE and DOUTx.STATEU are not affected by changes in this parameter. The drive input parameters DINx.STATE will be affected.

This parameter can be set at any time. It will be ignored unless DRV.EMUEMODE is set to 10.

7.12 DOUT Parameters

This section describes the DOUT parameters.

7.12.1 DOUT.CTRL	285
7.12.2 DOUT.RELAYMODE	286
7.12.3 DOUT.STATES	287
7.12.4 DOUT1.MODE to DOUT2.MODE	288
7.12.5 DOUT1.PARAM AND DOUT2.PARAM	290
7.12.6 DOUT1.STATE AND DOUT2.STATE	292
7.12.7 DOUT1.STATEU AND DOUT2.STATEU	293
7.12.8 DOUT9.STATE to DOUT11.STATE	294
7.12.9 DOUT9.STATEU to DOUT11.STATEU	295
7.12.10 DOUT21.STATE to DOUT32.STATE	297
7.12.11 DOUT21.STATEU to DOUT32.STATEU	299

7.12.1 DOUT.CTRL

General Information	
Type	NV Parameter
Description	Sets the source of digital output(s) (firmware or fieldbus).
Units	N/A
Range	0 to 1
Default Value	0
Data Type	Boolean
Start Version	M_01-00-00-000

SynqNet Information	
Range	1

Variants Supported

Variant	Supported
AKD Base	Yes
AKD with Position Indexer	Yes
AKD EtherCAT	Yes
AKD CANopen	Yes
AKD BASIC	Yes
AKD SynqNet	Yes
AKD EtherNet/IP	Yes
AKD Profinet	Yes
AKD sercos [®] III	Yes
AKD-N	Yes
AKD-C	No

Fieldbus Information

Fieldbus	Address	Attributes	Signed?
Profinet	2095	Byte	No
sercos [®] III		2 Octets	

Fieldbus	Index/Subindex	Is 64 bit?	Attributes	Signed?	Object Start Version
Modbus	190	No	8 bit	No	M_01-03-00-000

Description

DOUT.CTRL sets the source of the digital output(s):

0 = Firmware controlled

1 = Fieldbus controlled

7.12.2 DOUT.RELAYMODE

General Information	
Type	R/W Parameter
Description	Indicates faults relay mode.
Units	N/A
Range	0 to 1
Default Value	0
Data Type	Integer
Start Version	M_01-00-00-000

Variants Supported

Variant	Supported
AKD Base	Yes
AKD with Position Indexer	Yes
AKD EtherCAT	Yes
AKD CANopen	Yes
AKD BASIC	Yes
AKD SynqNet	Yes
AKD EtherNet/IP	Yes
AKD Profinet	Yes
AKD sercos [®] III	Yes
AKD-N	No
AKD-C	Yes

Fieldbus Information

Fieldbus	Address	Attributes	Signed?
Profinet	2096	Byte	No
sercos [®] III		2 Octets	

Fieldbus	Index/Subindex	Is 64 bit?	Attributes	Signed?	Object Start Version
Modbus	192	No	8 bit	No	M_01-03-00-000

Description

DOUT.RELAYMODE indicates the faults relay mode as follows:

If DOUT.RELAYMODE= 0 and faults exist, then the relay is open.

If DOUT.RELAYMODE= 0 and faults do not exist, then the relay is closed.

If DOUT.RELAYMODE = 1 and the drive is disabled, then the relay is open.

If DOUT.RELAYMODE = 1 and the drive is enabled, then the relay is closed.

7.12.3 DOUT.STATES

General Information	
Type	R/O Parameter
Description	Reads the state of the digital output (s).
Units	N/A
Range	0 to 11
Default Value	N/A
Data Type	String
Start Version	M_01-00-00-000

AKD BASIC Information	
Data Type	Integer

Variants Supported

Variant	Supported
AKD Base	Yes
AKD with Position Indexer	Yes
AKD EtherCAT	Yes
AKD CANopen	Yes
AKD BASIC	Yes
AKD SynqNet	Yes
AKD EtherNet/IP	Yes
AKD Profinet	Yes
AKD sercos [®] III	Yes
AKD-N	Yes
AKD-C	Yes

Fieldbus Information

Fieldbus	Index/Subindex	Is 64 bit?	Attributes	Signed?	Object Start Version
Modbus	194	No	8 bit	No	M_01-03-00-000

Description

DOUT.STATES reads the states of the digital output(s). The leftmost bit represents DOUT1 and the rightmost bit represents DOUT2.

NOTE AKD-C only reads the state of DOUT1.

7.12.4 DOUT1.MODE to DOUT2.MODE

General Information	
Type	NV Parameter
Description	Sets the digital output mode.
Units	N/A
Range	0 to 22
Default Value	0
Data Type	Integer
Start Version	M_01-04-02-000

AKD BASIC Information	
Range	0, 8, 10, 11, 15

AKD-C Information	
Range	0, 1, 7, 11, 16

AKD EtherNet/IP Information	
Range	0 to 2

Variants Supported

NOTE

AKD SynqNet disables digital output modes when SynqNet goes cyclic.

Variant	Supported
AKD Base	Yes
AKD with Position Indexer	Yes
AKD EtherCAT	Yes
AKD CANopen	Yes
AKD BASIC	Yes
AKD SynqNet	Yes
AKD EtherNet/IP	Yes
AKD Profinet	Yes
AKD sercos [®] III	Yes
AKD-N	Yes
AKD-C	Yes

Fieldbus Information

Paramter	Fieldbus	Address	Attributes	Signed?
DOUT1.MODE	Profinet	2098	Byte	No
	sercos [®] III		2 Octets	
DOUT2.MODE	Profinet	2103	Byte	
	sercos [®] III		2 Octets	

Fieldbus	Index/Subindex	Is 64 bit?	Attributes	Signed?	Object Start Version
Modbus	196	No	8 bit	No	M_01-03-00-000
	206				

Description

DOUTx.MODE sets the functionality of the digital output(s). The table below summarizes the digital output modes.

DOUTx.MODE	Description
0	User (default = 0)
8	Drive enabled
9	Reserved
10	Motor brake
11	Drive produced fault
15	PLS.STATE bits or connected

Related Topics

DOUT1.PARAM AND DOUT2.PARAM (pg 290)

7.12.5 DOUT1.PARAM AND DOUT2.PARAM

General Information	
Type	NV Parameter
Description	Sets extra parameters for the digital output(s).
Units	N/A
Range	0 Note: Range changes based on Digital Output Mode. See below.
Default Value	0
Data Type	Integer
Start Version	M_01-00-00-000

Variants Supported

Variant	Supported
AKD Base	Yes
AKD with Position Indexer	Yes
AKD EtherCAT	Yes
AKD CANopen	Yes
AKD BASIC	Yes
AKD SynqNet	Yes
AKD EtherNet/IP	Yes
AKD Profinet	Yes
AKD sercos [®] III	Yes
AKD-N	Yes
AKD-C	No

Fieldbus Information

Parameter	Fieldbus	Address	Attributes	Signed?
DOUT1.PARAM	Profinet	2099	DWord	Yes
	sercos [®] III		8 Octets	
DOUT2.PARAM	Profinet	2104	DWord	
	sercos [®] III		8 Octets	

Fieldbus	Index/Subindex	Is 64 bit?	Attributes	Signed?	Object Start Version
Modbus	198	Yes	64 bit	Yes	M_01-03-00-000
	208				

Description

Set the extra parameter needed for the digital output's calculations.

NOTE AKD-C and AKD-N only support DOUT1.

Range

DOUTx.PARAM is used for various Digital Output modes. This causes the parameter's range to change based on the current Digital Output mode selected with the corresponding DOUTx.MODE.

Below is a list of the possible range for each Digital Output Mode.

If an output mode is not listed, then the default range of 0 is used.

Input Mode	Min	Max	Notes
3	Position Min	Position Max	This value changes based on user selected position units.
4	Position Min	Position Max	This value changes based on user selected position units.
5	Position Min	Position Max	This value changes based on user selected position units.
6	Position Min	Position Max	This value changes based on user selected position units.
12	0	Velocity Max	This value changes based on user selected velocity units.
13	0	Velocity Max	This value changes based on user selected velocity units.
15	0	255	None.
17	Position Min	Position Max	This value changes based on user selected position units.

Dependency on DOUTx.MODE

Since the default range of DOUTx.PARAM does not allow a user to enter a value, DOUTx.MODE must be set to a mode which uses DOUTx.PARAM before a value can be set.

Each time DOUTx.MODE is changed, DOUTx.PARAM is automatically set to zero to prevent unintended interactions.

Digital Output Mode 15: PLS.STATE bits OR connected

The output mode produces a high signal if at least one of the PLS.STATE bits is high (the PLS is active) and if the corresponding bit in the DOUTx.PARAM parameter also has been set to high. The DOUTx.PARAM command connects the PLS.STATE bits to the digital output itself and thus acts as an enable mask.

In mode 15 DOUTx.PARAM is set from the Digital Outputs section of the Programmable Limit Switches screen.

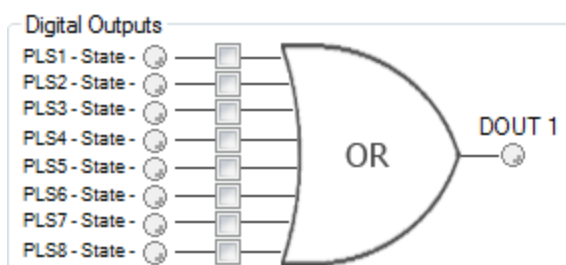

This mode is valid for all opmodes and command source combinations.

Example

```
|<- Bit 7 to 0 ->|
DOUT1.PARAM = 23 = 0b 0 0 0 1 0 1 1 1 (Binary code)
```

The digital output 1 is active when bit 0 or bit 1 or bit 2 or bit 4 of PLS.STATE is high. All other bits within PLS.STATE are not considered by the digital output mode due to the DOUT1.PARAM setting. Do not use decimal places for the DOUTx.PARAM parameter for this particular digital output mode.

7.12.6 DOUT1.STATE AND DOUT2.STATE

General Information	
Type	R/O Parameter
Description	Reads the digital output state.
Units	N/A
Range	0 to 1
Default Value	N/A
Data Type	Integer
Start Version	M_01-00-00-000

Variants Supported

Variant	Supported
AKD Base	Yes
AKD with Position Indexer	Yes
AKD EtherCAT	Yes
AKD CANopen	Yes
AKD BASIC	Yes
AKD SynqNet	Yes
AKD EtherNet/IP	Yes
AKD Profinet	Yes
AKD sercos [®] III	Yes
AKD-N	Yes
AKD-C	Yes

Fieldbus Information

Paramter	Fieldbus	Address	Attributes	Signed?
DOUT1.STATE	Profinet	2101	Byte	No
	sercos [®] III		2 Octets	
DOUT2.STATE	Profinet	2106	Byte	
	sercos [®] III		2 Octets	

Fieldbus	Index/Subindex	Is 64 bit?	Attributes	Signed?	Object Start Version
Modbus	202	No	8 bit	No	M_01-03-00-000
	212				

Description

Reads the state of one digital output according to the value stated in the command.

NOTE AKD-C and AKD-N only support DOUT1.

7.12.7 DOUT1.STATEU AND DOUT2.STATEU

General Information	
Type	R/W Parameter
Description	Sets the state of the digital output node.
Units	N/A
Range	0 to 1
Default Value	0
Data Type	Integer
Start Version	M_01-01-01-000

Variants Supported

Variant	Supported
AKD Base	Yes
AKD with Position Indexer	Yes
AKD EtherCAT	Yes
AKD CANopen	Yes
AKD BASIC	Yes
AKD SynqNet	Yes
AKD EtherNet/IP	Yes
AKD Profinet	Yes
AKD sercos [®] III	Yes
AKD-N	Yes
AKD-C	Yes

Fieldbus Information

Paramter	Fieldbus	Address	Attributes	Signed?
DOUT1.STATEU	Profinet	2102	Byte	No
	sercos [®] III		2 Octets	
DOUT2.STATEU	Profinet	2107	Byte	
	sercos [®] III		2 Octets	

Fieldbus	Index/Subindex	Is 64 bit?	Attributes	Signed?	Object Start Version
Modbus	204	No	8 bit	No	M_01-03-00-000
	214				

Description

Set the state of the digital output node as follows:

0 = deactivated

1 = activated

DOUT1.STATEU and DOUT2.STATEU are used when DOUT1.MODE to DOUT2.MODE (pg 288) = 0 (user mode).

NOTE

AKD-C and AKD-N only support DOUT1.

7.12.8 DOUT9.STATE to DOUT11.STATE

General Information	
Type	NV parameter
Description	Shows on selected pin if signal is high or low.
Units	N/A
Range	0 to 1
Default Value	0
Data Type	U8
Start Version	M_01-05-00-000

Variants Supported

Variant	Supported
AKD Base	Yes
AKD with Position Indexer	Yes
AKD EtherCAT	Yes
AKD CANopen	Yes
AKD BASIC	Yes
AKD SynqNet	Yes
AKD EtherNet/IP	Yes
AKD Profinet	Yes
AKD sercos [®] III	Yes
AKD-N	No
AKD-C	No

Fieldbus Information

Parameter	Fieldbus	Address	Attributes	Signed?
DOUT9.STATE	Profinet	2782	Byte	No
	sercos [®] III		2 Octets	
DOUT10.STATE	Profinet	2728	Byte	
	sercos [®] III		2 Octets	
DOUT11.STATE	Profinet	2730	Byte	
	sercos [®] III		2 Octets	

Fieldbus	Index/Subindex	Is 64 bit?	Attributes	Signed?	Object Start Version
Modbus	1564	No	8 bit	No	M_01-06-03-000
	1456				
	1460				

Description

This parameter allows the user to see the actual level of the output signal, when the IO is set to output mode. Parameter value is 0 if signal is low and 1 if signal is high. DIOx.INV can affect the signals driven onto the X9 connector.

This parameter can be read at any time. The value is only guaranteed to correspond to the output on the X9 connector when DRV.EMUEMODE is set to 10 and the DIOX.DIR is 0.

7.12.9 DOUT9.STATEU to DOUT11.STATEU

General Information	
Type	NV Parameter
Description	Allows user to set level of selected pin to high or low.
Units	N/A
Range	0 to 1
Default Value	0
Data Type	U8
Start Version	M_01-05-00-000

Variants Supported

Variant	Supported
AKD Base	Yes
AKD with Position Indexer	Yes
AKD EtherCAT	Yes
AKD CANopen	Yes
AKD BASIC	Yes
AKD SynqNet	Yes
AKD EtherNet/IP	Yes
AKD Profinet	Yes
AKD sercos [®] III	Yes
AKD-N	No
AKD-C	No

Fieldbus Information

Parameter	Fieldbus	Address	Attributes	Signed?
DOUT9.STATEU	Profinet	2783	Byte	No
	sercos [®] III		2 Octets	
DOUT10.STATEU	Profinet	2729	Byte	
	sercos [®] III		2 Octets	
DOUT11.STATEU	Profinet	2731	Byte	
	sercos [®] III		2 Octets	

Fieldbus	Index/Subindex	Is 64 bit?	Attributes	Signed?	Object Start Version	
Modbus	1566	DOUT9.STATEU	No	8 bit	No	M_01-06-03-000
	1458	DOUT10.STATEU				
	1462	DOUT11.STATEU				

Description

This parameter allows the user to set the level of the output signal, when the IO is set to output mode. Parameter value is 0 if signal is low and 1 if signal is high. DIOx.INV can affect the signals driven onto the X9 connector.

This parameter can be written at any time. The value is only guaranteed to correspond to the output on the X9 connector when DRV.EMUEMODE is set to 10 and the DIOX.DIR is 0.

Example

The following settings set the direction for the differential signals on pin 4 and 5, so that the output will have a high level signal.

First set the following settings:

```
DRV.EMUEMODE 10
```

```
DIO10.DIR 1
```

```
DOUT10.STATEU 1
```

Then change the level of the signal:

```
DOUT.STATEU 0
```

or

```
DIO10.INV
```

Note: Inverting the signal will also alter the signal in input mode.

7.12.10 DOUT21.STATE to DOUT32.STATE

General Information	
Type	R/O Parameter
Description	Reads the digital output state.
Units	N/A
Range	0 to 1
Default Value	N/A
Data Type	Integer
Start Version	M_01-00-00-000

Variants Supported

Supported by any AKD with extended IO.

Fieldbus Information

Parameter	Fieldbus	Address	Attributes	Signed?
DOUT21.STATE	Profinet	2735	Byte	No
	sercos [®] III		2 Octets	
DOUT22.STATE	Profinet	2740	Byte	
	sercos [®] III		2 Octets	
DOUT23.STATE	Profinet	2745	Byte	
	sercos [®] III		2 Octets	
DOUT24.STATE	Profinet	2750	Byte	
	sercos [®] III		2 Octets	
DOUT25.STATE	Profinet	2755	Byte	
	sercos [®] III		2 Octets	
DOUT26.STATE	Profinet	2760	Byte	
	sercos [®] III		2 Octets	
DOUT27.STATE	Profinet	2765	Byte	
	sercos [®] III		2 Octets	
DOUT28.STATE	Profinet	2770	Byte	
	sercos [®] III		2 Octets	
DOUT29.STATE	Profinet	2775	Byte	
	sercos [®] III		2 Octets	
DOUT30.STATE	Profinet	2780	Byte	
	sercos [®] III		2 Octets	

Fieldbus	Index/Subindex	Is 64 bit?	Attributes	Signed?	
Modbus	1470	DOUT21.STATE	No	8 bit	No
	1480	DOUT22.STATE			
	1490	DOUT23.STATE			
	1500	DOUT24.STATE			
	1510	DOUT25.STATE			
	1520	DOUT26.STATE			
	1530	DOUT27.STATE			
	1540	DOUT28.STATE			
	1550	DOUT29.STATE			
	1560	DOUT30.STATE			

Description

DOUTx.STATE reads the state of one digital output according to the value stated in the command.

7.12.11 DOUT21.STATEU to DOUT32.STATEU

General Information	
Type	R/W Parameter
Description	Sets the state of the digital output node.
Units	N/A
Range	0 to 1
Default Value	0
Data Type	Integer
Start Version	M_01-01-01-000

Variants Supported

Supported by any AKD with extended IO.

Fieldbus Information

Parameter	Fieldbus	Address	Attributes	Signed?
DOUT21.STATEU	Profinet	2736	Byte	No
	sercos [®] III		2 Octets	
DOUT22.STATEU	Profinet	2741	Byte	
	sercos [®] III		2 Octets	
DOUT23.STATEU	Profinet	2746	Byte	
	sercos [®] III		2 Octets	
DOUT24.STATEU	Profinet	2751	Byte	
	sercos [®] III		2 Octets	
DOUT25.STATEU	Profinet	2756	Byte	
	sercos [®] III		2 Octets	
DOUT26.STATEU	Profinet	2761	Byte	
	sercos [®] III		2 Octets	
DOUT27.STATEU	Profinet	2766	Byte	
	sercos [®] III		2 Octets	
DOUT28.STATEU	Profinet	2771	Byte	
	sercos [®] III		2 Octets	
DOUT29.STATEU	Profinet	2776	Byte	
	sercos [®] III		2 Octets	
DOUT30.STATEU	Profinet	2781	Byte	
	sercos [®] III		2 Octets	

Fieldbus	Index/Subindex	Is 64 bit?	Attributes	Signed?	
Modbus	1472	DOUT21.STATEU	No	8 bit	No
	1482	DOUT22.STATEU			
	1492	DOUT23.STATEU			
	1502	DOUT24.STATEU			
	1512	DOUT25.STATEU			
	1522	DOUT26.STATEU			
	1532	DOUT27.STATEU			
	1542	DOUT28.STATEU			
	1552	DOUT29.STATEU			
	1562	DOUT30.STATEU			

Description

DOUTx.STATEU sets the state of the digital output node as follows:

0 = deactivated

1 = activated

DOUTx.STATEU is used when DOUT1.MODE to DOUT2.MODE (pg 288) = 0 (user mode).

7.13 DRV Parameters

This section describes the DRV parameters.

7.13.1 DRV.ACC	303
7.13.2 DRV.ACTIVE	305
7.13.3 DRV.BLINKDISPLAY	306
7.13.4 DRV.BOOTTIME	307
7.13.5 DRV.CLRCRASHDUMP	308
7.13.6 DRV.CLRFAULTHIST	309
7.13.7 DRV.CLRFAULTS	310
7.13.8 DRV.CMDDELAY	311
7.13.9 DRV.CMDSOURCE	312
7.13.10 DRV.CRASHDUMP	314
7.13.11 DRV.DBILIMIT	315
7.13.12 DRV.DEC	316
7.13.13 DRV.DIFVAR	318
7.13.14 DRV.DIR	319
7.13.15 DRV.DIS	320
7.13.16 DRV.DISMODE	321
7.13.17 DRV.DISSOURCES	323
7.13.18 DRV.DISTO	325
7.13.19 DRV.EMUECHECKSPEED	326
7.13.20 DRV.EMUEDIR	327
7.13.21 DRV.EMUEMODE	328
7.13.22 DRV.EMUEMTURN	330
7.13.23 DRV.EMUEPULSEWIDTH	332
7.13.24 DRV.EMUERES	334
7.13.25 DRV.EMUEZOFFSET	335
7.13.26 DRV.EN	337
7.13.27 DRV.ENDEFAULT	338
7.13.28 DRV.FAULTHIST	339
7.13.29 DRV.FAULTS	340
7.13.30 DRV.FAULT1 to DRV.FAULT10	341
7.13.31 DRV.HANDWHEEL	343
7.13.32 DRV.HANDWHEELSRC	345
7.13.33 DRV.HELP	346
7.13.34 DRV.HELPALL	347
7.13.35 DRV.HWENABLE	348

7.13.36 DRV.HWENDELAY	349
7.13.37 DRV.HWENMODE	350
7.13.38 DRV.ICONT	351
7.13.39 DRV.INFO	352
7.13.40 DRV.IPEAK	355
7.13.41 DRV.IZERO	356
7.13.42 DRV.LIST	357
7.13.43 DRV.LOGICVOLTS	358
7.13.44 DRV.MEMADDR	359
7.13.45 DRV.MEMDATA	360
7.13.46 DRV.MOTIONDISSOURCES	361
7.13.47 DRV.MOTIONSTAT	362
7.13.48 DRV.NAME	364
7.13.49 DRV.NVCHECK	365
7.13.50 DRV.NVLIST	366
7.13.51 DRV.NVLOAD	367
7.13.52 DRV.NVSAVE	368
7.13.53 DRV.ONTIME	369
7.13.54 DRV.OPMODE	370
7.13.55 DRV.READFORMAT	372
7.13.56 DRV.RSTVAR	373
7.13.57 DRV.RUNTIME	374
7.13.58 DRV.SETUPREQBITS	375
7.13.59 DRV.SETUPREQLIST	377
7.13.60 DRV.STOP	378
7.13.61 DRV.SWENABLE	379
7.13.62 DRV.TEMPERATURES	380
7.13.63 DRV.TIME	381
7.13.64 DRV.TYPE	382
7.13.65 DRV.VER	384
7.13.66 DRV.VERIMAGE	385
7.13.67 DRV.WARNINGS	386
7.13.68 DRV.WARNING1 to DRV.WARNING3	387
7.13.69 DRV.ZERO	389

7.13.1 DRV.ACC

General Information	
Type	NV Parameter
Description	Describes the acceleration ramp for the velocity loop.
Units	Depends on UNIT.ACCROTARY (pg 713) or UNIT.ACCLINEAR (pg 712) Rotary: rps/s, rpm/s, deg/s ² , (custom units)/s ² , rad/s ² Linear: counts/s ² , mm/s ² , μm/s ² , (custom units)/s ²
Range	Note: The range and default values of (custom units)/s ² units depend on the values of PIN and POUT. The range and default values listed in this table are derived from the default values of PIN and POUT. Rotary: 0.002 to 833,333.333 rps/s 0.112 to 50,000,000.000 rpm/s 0.009 to 300,000,000.000 deg/s ² 0.155 to 4,166,666.752 (custom units)/s ² 0.012 to 5,235,987.968 rad/s ² Linear: 16,000.000 to 3,579,139,408,000.000 counts/s ² 0.031*MOTOR.PITCH (pg 570) to 833,333.333*MOTOR.PITCH (pg 570) mm/s ² 30.995*MOTOR.PITCH (pg 570) to 2,147,483.647*MOTOR.PITCH (pg 570) μm/s ² 0.155 to 2,147,483.647 (custom units)/s ²
Default Value	Note: The range and default values of (custom units)/s ² units depend on the values of PIN and POUT. The range and default values listed in this table are derived from the default values of PIN and POUT. Rotary: 166.669 rps/s 10,000.000 rpm/s 60,000.000 deg/s ² 833.333 (custom units)/s ² 1,047.2 rad/s ² Linear: 715,840,000.000 counts/s ² 166.714*MOTOR.PITCH (pg 570) mm/s ² 166,714.191*MOTOR.PITCH (pg 570) μm/s ² 833.571 (custom units)/s ²
Data Type	Float
Start Version	M_01-00-00-000

Variants Supported

Variant	Supported
AKD Base	Yes
AKD with Position Indexer	Yes
AKD EtherCAT	Yes
AKD CANopen	Yes

Variant	Supported
AKD BASIC	Yes
AKD SynqNet	Yes
AKD EtherNet/IP	Yes
AKD Profinet	Yes
AKD sercos [®] III	Yes
AKD-N	Yes
AKD-C	No

Fieldbus Information

Fieldbus	Index/Subindex	Object Start Version
EtherCAT COE and CANopen CANopen	3501h/0	M_01-00-00-000

Fieldbus	Address	Attributes	Signed?
Profinet	2108	DWord	No
sercos [®] III		8 Octets	

Fieldbus	Index/Subindex	Is 64 bit?	Attributes	Signed?	Object Start Version
Modbus	216	Yes	64 bit	No	M_01-03-00-000

Description

Describes the acceleration ramp for the velocity central loop.

Related Topics

DRV.DEC (pg 316)

7.13.2 DRV.ACTIVE

General Information	
Type	R/O Parameter
Description	Reads the enable status of an axis.
Units	N/A
Range	0, 1, 3
Default Value	N/A
Data Type	Integer
Start Version	M_01-00-00-000

Variants Supported

Variant	Supported
AKD Base	Yes
AKD with Position Indexer	Yes
AKD EtherCAT	Yes
AKD CANopen	Yes
AKD BASIC	Yes
AKD SynqNet	Yes
AKD EtherNet/IP	Yes
AKD Profinet	Yes
AKD sercos [®] III	Yes
AKD-N	Yes
AKD-C	No

Fieldbus Information

Fieldbus	Index/Subindex	Is 64 bit?	Attributes	Signed?	Object Start Version
Modbus	220	No	8 bit	No	M_01-03-00-000

Description

DRV.ACTIVE reads the enable status of an axis as follows:

- DRV.ACTIVE = 0 drive disabled
- DRV.ACTIVE = 1 drive enabled
- DRV.ACTIVE = 3 drive enabled and in dynamic brake mode

There is no state 2.

When the drive is in state 3, the drive display shows a blinking decimal point. Additionally, if the drive is in state 3 the Parameter Load/Save view does not allow you to download a parameter file.

If an axis is not enabled (DRV.ACTIVE is 0), but DRV.EN (pg 337) is 1 and the hardware enable is high, read the value of DRV.DISSOURCES (pg 323) to query the reason that the drive is not enabled.

Related Topics

DRV.EN (pg 337), DRV.DISSOURCES (pg 323)

7.13.3 DRV.BLINKDISPLAY

General Information	
Type	Command
Description	Causes the display to blink for 10 seconds.
Units	N/A
Range	N/A
Default Value	N/A
Data Type	N/A
Start Version	M_01-00-00-000

Variants Supported

Variant	Supported
AKD Base	Yes
AKD with Position Indexer	Yes
AKD EtherCAT	Yes
AKD CANopen	Yes
AKD BASIC	Yes
AKD SynqNet	Yes
AKD EtherNet/IP	Yes
AKD Profinet	Yes
AKD sercos [®] III	Yes
AKD-N	Yes
AKD-C	Yes

Fieldbus Information

Fieldbus	Address	Attributes	Signed?
Profinet sercos [®] III	2784	Command	No

Fieldbus	Index/Subindex	Is 64 bit?	Attributes	Signed?	Object Start Version
Modbus	1568	No	Command	No	M_01-06-03-000

Description

DRV.BLINKDISPLAY causes the drive display located on the front of the drive to blink for 10 seconds. This command allows the user to identify the drive that is currently communicating with WorkBench.

7.13.4 DRV.BOOTTIME

General Information	
Type	R/O
Description	Returns the time when the current session booted up.
Units	Days:Hours:Minutes:Seconds
Range	N/A
Default Value	N/A
Data Type	String
Start Version	M_01-06-05-000

Variants Supported

Variant	Supported
AKD Base	Yes
AKD with Position Indexer	Yes
AKD EtherCAT	Yes
AKD CANopen	Yes
AKD BASIC	Yes
AKD SynqNet	Yes
AKD EtherNet/IP	Yes
AKD Profinet	Yes
AKD sercos [®] III	Yes
AKD-N	Yes
AKD-C	Yes

Description

DRV.BOOTTIME returns the time that the current session started running. This time includes total amount of time from all previous sessions.

This keyword can be used with DRV.RUNTIME to determine the length of time the drive has been running since it was last power cycled.

Session Time = DRV.RUNTIME – DRV.BOOTTIME

7.13.5 DRV.CLRCRASHDUMP

General Information	
Type	Command
Description	Clears old diagnostic information.
Units	N/A
Range	N/A
Default Value	N/A
Data Type	N/A
Start Version	M_01-04-00-005

Variants Supported

Variant	Supported
AKD Base	Yes
AKD with Position Indexer	Yes
AKD EtherCAT	Yes
AKD CANopen	Yes
AKD BASIC	Yes
AKD SynqNet	Yes
AKD EtherNet/IP	Yes
AKD Profinet	Yes
AKD sercos [®] III	Yes
AKD-N	Yes
AKD-C	Yes

Fieldbus Information

Fieldbus	Address	Attributes	Signed?
Profinet sercos [®] III	2785	Command	No

Fieldbus	Index/Subindex	Is 64 bit?	Attributes	Signed?	Object Start Version
Modbus	1570	No	Command	No	M_01-06-03-000

Description

Since the NV memory block is overwritten, but never erased, the DRV.CRASHDUMP command always shows the diagnostic information for the most recent crash. In some instances it is helpful to erase an old crashdump. Use DRV.CLRCRASHDUMP for this purpose.

7.13.6 DRV.CLRFAULTHIST

General Information	
Type	Command
Description	Clears the fault history log in the NV.
Units	N/A
Range	N/A
Default Value	N/A
Data Type	N/A
Start Version	M_01-00-00-000

Variants Supported

Variant	Supported
AKD Base	Yes
AKD with Position Indexer	Yes
AKD EtherCAT	Yes
AKD CANopen	Yes
AKD BASIC	Yes
AKD SynqNet	Yes
AKD EtherNet/IP	Yes
AKD Profinet	Yes
AKD sercos [®] III	Yes
AKD-N	Yes
AKD-C	Yes

Fieldbus Information

Fieldbus	Address	Attributes	Signed?
Profinet sercos [®] III	2111	Command	No

Fieldbus	Index/Subindex	Is 64 bit?	Attributes	Signed?	Object Start Version
Modbus	222	No	Command	No	M_01-03-00-000

Description

DRV.CLRFAULTHIST clears the fault history from the nonvolatile memory of the drive. This command erases all faults returned by DRV.FAULTHIST (pg 339).

7.13.7 DRV.CLRFAULTS

General Information	
Type	Command
Description	Tries to clear all active faults in the drive.
Units	N/A
Range	N/A
Default Value	N/A
Data Type	N/A
Start Version	M_01-00-00-000

Variants Supported

Variant	Supported
AKD Base	Yes
AKD with Position Indexer	Yes
AKD EtherCAT	Yes
AKD CANopen	Yes
AKD BASIC	Yes
AKD SynqNet	Yes
AKD EtherNet/IP	Yes
AKD Profinet	Yes
AKD sercos [®] III	Yes
AKD-N	Yes
AKD-C	Yes

Fieldbus Information

Fieldbus	Address	Attributes	Signed?
Profinet sercos [®] III	2112	Command	No

Fieldbus	Index/Subindex	Is 64 bit?	Attributes	Signed?	Object Start Version
Modbus	224	No	Command	No	M_01-03-00-000

Description

When DRV.CLRFAULTS is sent, the drive will try to clear all active faults. When a fault occurs, the fault is registered in the drive fault handler. DRV.CLRFAULTS clears the fault from the drive fault handler. However, if the fault still exists in the system, DRV.CLRFAULTS fails and the fault is re-registered in the fault handler.

If the DRV.CLRFAULTS succeeds, then the reply to DRV.FAULTS states that no faults exist. If the condition that triggered the fault is still present, the fault condition will remain.

Note that executing a drive disable (DRV.DIS (pg 320)) followed by a drive enable (DRV.EN (pg 337)) has the same effect as executing DRV.CLRFAULTS.

Related Topics

DRV.FAULTS (pg 340), DRV.EN (pg 337), DRV.DIS (pg 320)

7.13.8 DRV.CMDDELAY

General Information	
Type	Command
Description	Issues a delay before next command is executed.
Units	ms
Range	0 to 5,000 ms
Default Value	0 ms
Data Type	Float
Start Version	M_01-03-00-000

Variants Supported

Variant	Supported
AKD Base	Yes
AKD with Position Indexer	Yes
AKD EtherCAT	Yes
AKD CANopen	Yes
AKD BASIC	Yes
AKD SynqNet	Yes
AKD EtherNet/IP	Yes
AKD Profinet	Yes
AKD sercos [®] III	Yes
AKD-N	Yes
AKD-C	No

Fieldbus Information

Fieldbus	Index/Subindex	Is 64 bit?	Attributes	Signed?	Object Start Version
Modbus	1572	No		No	M_01-06-03-000

Description

This parameter is used when drive commands are used in a script and a delay is needed between the execution of two consecutive commands. DRV.CMDDELAY creates a delay in the execution of drive commands. In the period of time specified, no commands are executed. This feature is especially useful for command buffers.

Example

If the script is:

```
DRV.EN
IL.CMDU 0.1
```

then DRV.CMDDELAY is used between the two entries to delay execution 5 ms until the drive is enabled:

```
DRV.EN
DRV.CMDDELAY 5
IL.CMDU 0.1
```

7.13.9 DRV.CMDSOURCE

General Information	
Type	NV Parameter
Description	Sets the command source (service, fieldbus, analog input, gearing, digital, or Bode).
Units	N/A
Range	0 to 5
Default Value	0
Data Type	Integer
Start Version	M_01-00-00-000

AKD SynqNet Information	
Range	0

AKD BASIC Information	
Range	0, 3, 5

Variants Supported

Variant	Supported
AKD Base	Yes
AKD with Position Indexer	Yes
AKD EtherCAT	Yes
AKD CANopen	Yes
AKD BASIC	Yes
AKD SynqNet	Yes
AKD EtherNet/IP	Yes
AKD Profinet	Yes
AKD sercos [®] III	Yes
AKD-N	Yes
AKD-C	No

Fieldbus Information

Fieldbus	Address	Attributes	Signed?
Profinet	2113	Byte	No
sercos [®] III		2 Octets	

Fieldbus	Index/Subindex	Is 64 bit?	Attributes	Signed?	Object Start Version
Modbus	226	No	8 bit	No	M_01-03-00-000

Description

DRV.CMDSOURCE specifies the source of the command to the drive. DRV.OPMODE (pg 370) sets the operation mode to the relevant control loop.

DRV.CMDSOURCE values can be set as follows:

Value	Description
0	Service, TCP/IP command
3	Analog command
5	Program command

If DRV.CMDSOURCE is set to 5 then DRV.OPMODE must be set to 3.

DRV.CMDSOURCE can be changed while the drive is enabled or disabled. If you use the terminal to change the operation mode, then it is recommended that you disable the drive before changing the command source.



If you change DRV.CMDSOURCE from the terminal while the drive is enabled, the system may experience a step change in command.

Example

To set the command source to the TCP/IP channel and the operation mode to velocity:

```
-->DRV.CMDSOURCE 0  
-->DRV.OPMODE 1
```

Related Topics

DRV.OPMODE (pg 370)

7.13.10 DRV.CRASHDUMP

General Information	
Type	Command
Description	Retrieves diagnostic information after the drive crashes.
Units	N/A
Range	N/A
Default Value	N/A
Data Type	N/A
Start Version	M_01-00-00-000

Variants Supported

Variant	Supported
AKD Base	Yes
AKD with Position Indexer	Yes
AKD EtherCAT	Yes
AKD CANopen	Yes
AKD BASIC	Yes
AKD SynqNet	Yes
AKD EtherNet/IP	Yes
AKD Profinet	Yes
AKD sercos [®] III	Yes
AKD-N	Yes
AKD-C	Yes

Description

Drives rarely crash, but if a crash occurs, information that can help diagnose the cause of a crash is saved to the nonvolatile (NV) memory within the drive. After the drive is restarted, you can use the DRV.CRASHDUMP command to retrieve this diagnostic information, which can be emailed to Kollmorgen for further support.

If the drive crashes (display flashes an F and three bars), it saves the diagnostic information to a specific block of the drive NV memory. The DRV.CRASHDUMP command then prints the diagnostic information from this NV memory block. Subsequent crash conditions will overwrite the NV memory block. Since the NV memory block is overwritten, but never erased, the DRV.CRASHDUMP command always shows the diagnostic information for the most recent crash.

7.13.11 DRV.DBILIMIT

General Information	
Type	NV Parameter
Description	Sets the maximum amplitude of the current for dynamic braking.
Units	Arms
Range	0 to minimum of drive peak current (DRV.IPEAK) and motor peak current (MOTOR.IPEAK).
Default Value	Minimum of drive continuous current (DRV.ICONT) and motor continuous current (MOTOR.ICONT).
Data Type	Float
Start Version	M_01-00-00-000

Variants Supported

Variant	Supported
AKD Base	Yes
AKD with Position Indexer	Yes
AKD EtherCAT	Yes
AKD CANopen	Yes
AKD BASIC	Yes
AKD SynqNet	Yes
AKD EtherNet/IP	Yes
AKD Profinet	Yes
AKD sercos [®] III	Yes
AKD-N	Yes
AKD-C	No

Fieldbus Information

Fieldbus	Index/Subindex	Object Start Version
EtherCAT COE and CANopen CANopen	3444h/0	M_01-00-00-000

Fieldbus	Address	Attributes	Signed?
Profinet	2114	DWord	No
sercos [®] III		4 Octets	

Fieldbus	Index/Subindex	Is 64 bit?	Attributes	Signed?	Object Start Version
Modbus	228	No	32 bit	No	M_01-03-00-000

Description

This parameter sets the maximum amplitude of the current for dynamic braking.

Example

Setting DRV.DBILIMIT to 2 limits the dynamic brake current to 2 Arms.

Related Topics

DRV.DISMODE (pg 321)

7.13.12 DRV.DEC

General Information	
Type	NV Parameter
Description	Sets the deceleration value for the velocity loop.
Units	Depends on UNIT.ACCROTARY (pg 713) or UNIT.ACCLINEAR (pg 712) Rotary: rps/s, rpm/s, deg/s ² , (custom units)/s ² , rad/s ² Linear: counts/s ² , mm/s ² , μm/s ² , (custom units)/s ²
Range	Rotary: 0.002 to 833,333.333 rps/s 0.112 to 50,000,000.000 rpm/s 0.009 to 300,000,000.000 deg/s ² 0.155 to 4,166,666.752 (custom units)/s ² 0.012 to 5,235,987.968 rad/s ² Linear: 16,000.000 to 3,579,139,408,000.000 counts/s ² 0.031*MOTOR.PITCH to 833,333.333*MOTOR.PITCH mm/s ² 30.994*MOTOR.PITCH to 833,333,333.333*MOTOR.PITCH μm/s ² 0.155 to 4,166,666.667 (custom units)/s ²
Default Value	Rotary: 166.669 rps/s 10,000.000 rpm/s 60,000.000 deg/s ² 833.333 (custom units)/s ² 1,047.2 rad/s ² Linear: 715,840,000.000 counts/s ² 166.71*MOTOR.PITCH4MOTOR.PITCH (pg 570) mm/s ² 166,714.191*MOTOR.PITCHMOTOR.PITCH (pg 570) μm/s ² 833.571 (custom units)/s ²
Data Type	Float
Start Version	M_01-00-00-000

Variants Supported

Variant	Supported
AKD Base	Yes
AKD with Position Indexer	Yes
AKD EtherCAT	Yes
AKD CANopen	Yes
AKD BASIC	Yes
AKD SynqNet	Yes
AKD EtherNet/IP	Yes
AKD Profinet	Yes
AKD sercos [®] III	Yes
AKD-N	Yes
AKD-C	No

Fieldbus Information

Fieldbus	Index/Subindex	Object Start Version
EtherCAT COE and CANopen CANopen	3522h/0	M_01-00-00-000

Fieldbus	Address	Attributes	Signed?
Profinet	2115	DWord	No
sercos [®] III		8 Octets	

Fieldbus	Index/Subindex	Is 64 bit?	Attributes	Signed?	Object Start Version
Modbus	230	Yes	64 bit	No	M_01-03-00-000

Description

DRV.DEC sets the deceleration value for the velocity loop command (VL.CMDU (pg 744)) and for the analog

velocity command (). The operation mode (DRV.OPMODE (pg 370)) must be set to velocity mode for this command to function.

Related Topics

DRV.ACC (pg 303), DRV.OPMODE (pg 370)

7.13.13 DRV.DIFVAR

General Information	
Type	R/O
Description	Lists all parameters which differ from their default value.
Units	N/A
Range	N/A
Default Value	N/A
Data Type	N/A
Start Version	M_01-05-01-000

Variants Supported

Variant	Supported
AKD Base	Yes
AKD with Position Indexer	Yes
AKD EtherCAT	Yes
AKD CANopen	Yes
AKD BASIC	Yes
AKD SynqNet	Yes
AKD EtherNet/IP	Yes
AKD Profinet	Yes
AKD sercos [®] III	Yes
AKD-N	Yes
AKD-C	Yes

Description

This parameter displays all parameters which have different values than their default setting. The actual value of each parameter is directly shown after the command name and the corresponding default value is then shown in brackets.

This command also shows differences in parameters which hold a string, such as DRV.NAME.

Example

```
-->DRV.DIFVAR
DRV.EMUEMODE 10 (0)
DRV.NAME MyDrive(no-name)
FB1.ENCRESES 0(1024)
IL.KP 50.009(24.811)
PL.KP 99.998(49.999)
VL.KP 0.108(0.000)
```

7.13.14 DRV.DIR

General Information	
Type	R/W Parameter
Description	Changes drive direction.
Units	N/A
Range	0 to 1
Default Value	0
Data Type	Integer
Start Version	M_01-00-00-000

Variants Supported

Variant	Supported
AKD Base	Yes
AKD with Position Indexer	Yes
AKD EtherCAT	Yes
AKD CANopen	Yes
AKD BASIC	Yes
AKD SynqNet	Yes
AKD EtherNet/IP	Yes
AKD Profinet	Yes
AKD sercos [®] III	Yes
AKD-N	Yes
AKD-C	No

Fieldbus Information

Fieldbus	Index/Subindex	Is 64 bit?	Attributes	Signed?	Object Start Version
Modbus	234	No	8 bit	No	M_01-03-00-000

Description

DRV.DIR changes the direction of the motor by changing the algebraic sign of the current command and position feedback value according to the figure below.

Note the following when using DRV.DIR:

- You can only change the DRV.DIR command when the drive is disabled.
- The drive status changes to "Axis not homed" as soon as the DRV.DIR parameter changes value (see DRV.MOTIONSTAT (pg 362)).
- You must verify the settings of the hardware limit switches. If necessary, switch the positive and negative hardware limit switches by swapping the wires at the digital inputs.

7.13.15 DRV.DIS

General Information	
Type	Command
Description	Disables the axis (software).
Units	N/A
Range	N/A
Default Value	Analog drive software enabled. All other types of drive software disabled.
Data Type	N/A
Start Version	M_01-00-00-000

Variants Supported

Variant	Supported
AKD Base	Yes
AKD with Position Indexer	Yes
AKD EtherCAT	Yes
AKD CANopen	Yes
AKD BASIC	Yes
AKD SynqNet	Yes
AKD EtherNet/IP	Yes
AKD Profinet	Yes
AKD sercos [®] III	Yes
AKD-N	Yes
AKD-C	Yes

Fieldbus Information

Fieldbus	Index/Subindex	Is 64 bit?	Attributes	Signed?	Object Start Version
Modbus	236	No	Command	No	M_01-03-00-000

Description

DRV.DIS issues a software disable to the drive. The method by which the drive will be disabled (either immediately or with a ramp down first) is controlled by DRV.DISMODE (pg 321).

By querying the value of DRV.ACTIVE (pg 305), you can check whether the drive is currently enabled or disabled.

By querying the value of DRV.DISSOURCES (pg 323), you can check whether the software enable bit is high (software enabled was issued by executing DRV.EN) or the software enable bit is low (software disable was issued by executing DRV.DIS).

If DRV.DIS is commanded the emergency timeout is started. If the drive does not disable or activate dynamic brake within DRV.DISTO (pg 325), fault 703 is reported.

Related Topics

DRV.EN (pg 337), DRV.DISSOURCES (pg 323), DRV.ACTIVE (pg 305), DRV.DISMODE (pg 321), DRV.DISTO (pg 325)

7.13.16 DRV.DISMODE

General Information	
Type	NV Parameter
Description	Selects among disable immediately or stop and then disable options.
Units	N/A
Range	0 to 3
Default Value	0
Data Type	Integer
Start Version	M_01-00-00-000

SynqNet Information	
Range	0 to 2

Variants Supported

Variant	Supported
AKD Base	Yes
AKD with Position Indexer	Yes
AKD EtherCAT	Yes
AKD CANopen	Yes
AKD BASIC	Yes
AKD SynqNet	Yes
AKD EtherNet/IP	Yes
AKD Profinet	Yes
AKD sercos [®] III	Yes
AKD-N	Yes
AKD-C	No

Fieldbus Information

Fieldbus	Index/Subindex	Object Start Version
EtherCAT COE and CANopen CANopen	35FFh/0	M_01-00-00-000

Fieldbus	Address	Attributes	Signed?
Profinet	2119	Byte	No
sercos [®] III		2 Octets	

Fieldbus	Index/Subindex	Is 64 bit?	Attributes	Signed?	Object Start Version
Modbus	238	No	8 bit	No	M_01-03-00-000

Description

DRV.DISMODE sets the drive reaction to a DRV.DIS (pg 320) command.

NOTE

You must disable the drive in order to set DRV.DISMODE.

Value	Behavior
0	Disable axis immediately.
1	Use dynamic brake to ramp down. The drive remains in the dynamic brake state after the motor has stopped. The drive is disabled in the sense that it does not close the control loop and cannot perform a motion, but PWM stays active.
2	Use a controlled stop to ramp down and then disable the drive.
3	Use a controlled stop to ramp down, and then use dynamic brake. The drive remains in the dynamic brake state after the motor has stopped. The drive is disabled in the sense that it does not close the control loop and cannot perform a motion, but PWM stays active.

In all cases described above, if a brake is configured (MOTOR.BRAKE (pg 550)), the brake closes if VL.FB (pg 747) drops below CS.VTHRESH (pg 258).

⚠WARNING

Be careful with vertical loads when modifying this parameter. Coordinate this parameter's correct setting properly with the drive brake settings. If these settings are not coordinated, then vertical loads may have no stopping or holding force when the drive is disabled and the load could fall.

Related Topics

7.9 CS Parameters

DRV.DBILIMIT (pg 315), DRV.DISTO (pg 325), CS.VTHRESH (pg 258)

7.13.17 DRV.DISSOURCES

General Information	
Type	R/O Parameter
Description	Returns the possible reason for a drive disable.
Units	N/A
Range	N/A
Default Value	N/A
Data Type	Integer
Start Version	M_01-00-00-000

Variants Supported

Variant	Supported
AKD Base	Yes
AKD with Position Indexer	Yes
AKD EtherCAT	Yes
AKD CANopen	Yes
AKD BASIC	Yes
AKD SynqNet	Yes
AKD EtherNet/IP	Yes
AKD Profinet	Yes
AKD sercos [®] III	Yes
AKD-N	Yes
AKD-C	Yes

Fieldbus Information

Fieldbus	Address	Attributes	Signed?
Profinet	2120	Word	No
sercos [®] III		2 Octets	

Fieldbus	Index/Subindex	Is 64 bit?	Attributes	Signed?	Object Start Version
Modbus	240	No	16 bit	No	M_01-03-00-000

Description

DRV.DISSOURCES is a bitwise parameter that returns the status of possible causes of a drive disable. If this parameter is 0, then the drive is enabled.

The return value specific bits are as follows:

Bit	Status and Response	Drive Action
0	Software disable (execute DRV.EN to issue software enable)	Performs action configured by DRV.DISMODE.
1	Fault exists (read DRV.FAULTS to get the active faults)	Device disables using the defined reaction for the detected fault.
2	Hardware disable (remote enable input is low)	Power stage disabled.
3	In-rush disable (the in-rush relay is opened)	Performs action configured by DRV.DISMODE.

Bit	Status and Response	Drive Action
4	Initialization disable (the drive did not finish the initialization process)	Power stage disabled.
5	Controlled stop disable from a digital input.	Controlled stop.
6	Field Bus requested disable (SynqNet and EtherNet/IP only)	Performs action configured by DRV.DISMODE.
7	AKD-C requested disable (AKD-N only)	Performs action configured by DRV.DISMODE.
10	AKD-C in download mode.	Disables all AKD-Ns on the AKD-C's strings.

Related Topics

DRV.ACTIVE, DRV.FAULTS, DRV.EN, DRV.DIS

7.13.18 DRV.DISTO

General Information	
Type	R/W Parameter
Description	Sets the emergency timeout
Units	ms
Range	0 to 120,000 ms
Default Value	1,000 ms
Data Type	U32
Start Version	M_01-00-00-000

Variants Supported

Variant	Supported
AKD Base	Yes
AKD with Position Indexer	Yes
AKD EtherCAT	Yes
AKD CANopen	Yes
AKD BASIC	Yes
AKD SynqNet	Yes
AKD EtherNet/IP	Yes
AKD Profinet	Yes
AKD sercos [®] III	Yes
AKD-N	Yes
AKD-C	No

Fieldbus Information

Fieldbus	Index/Subindex	Object Start Version
EtherCAT COE and CANopen CANopen	3445h/0	M_01-00-00-000

Fieldbus	Address	Attributes	Signed?
Profinet	2121	DWord	No
sercos [®] III		4 Octets	

Fieldbus	Index/Subindex	Is 64 bit?	Attributes	Signed?	Object Start Version
Modbus	242	No	32 bit	No	M_01-03-00-000

Description

This timer starts when DRV.DIS (pg 320) is issued (regardless of the DRV.DIS (pg 320) origin). After this timeout elapses, the actual state of the drive is compared to the DRV.DISMODE (pg 321) setting. If the actual state does not match the DRV.DISMODE (pg 321) setting, a fault is reported and the hardware immediately executes the DRV.DISMODE setting (for instance, disable or activate dynamic brake). Setting DRV.DISTO to 0 will disable the timeout.

Related Topics

DRV.DIS (pg 320), DRV.DISMODE (pg 321)

7.13.19 DRV.EMUECHECKSPEED

General Information	
Type	R/W
Description	Enable/disable comparison of motor velocity and maximum emulated encoder velocity. See Fault F486 for details.
Units	None
Range	0 to 1
Default Value	0 (disabled)
Data Type	Boolean
Start Version	M_01-06-00-000

Variants Supported

Variant	Supported
AKD Base	Yes
AKD with Position Indexer	Yes
AKD EtherCAT	Yes
AKD CANopen	Yes
AKD BASIC	Yes
AKD SynqNet	Yes
AKD EtherNet/IP	Yes
AKD Profinet	Yes
AKD sercos [®] III	Yes
AKD-N	No
AKD-C	No

Fieldbus Information

Fieldbus	Address	Attributes	Signed?
Profinet	2526	Byte	No
sercos [®] III		2 Octets	

Fieldbus	Index/Subindex	Is 64 bit?	Attributes	Signed?
Modbus	1052	No	8 bit	No

Description

Enables comparison of the current motor velocity (or EEO pulse rate for DRV.EMUEMODE (pg 328) 15 to 17) against the maximum speed the emulated encoder output can generate. If the commanded speed exceeds DRV.EMUECHECKSPEED, fault F486 is raised.

For DRV.EMUEMODE 1 to 14, the commanded speed is based on lines/rev (DRV.EMUERES (pg 334)) and the pulse width (DRV.EMUEPULSEWIDTH (pg 332)).

For DRV.EMUEMODE 15 to 17 the commanded speed depends on the rate defined by changes in DRV.EMUESTPCMD.

Related Topics

DRV.EMUEMODE

7.13.20 DRV.EMUEDIR

General Information	
Type	R/W Parameter
Description	Sets the direction of the emulated encoder output (EEO) signal.
Units	N/A
Range	0 to 1
Default Value	0
Data Type	Integer
Start Version	M_01-00-00-000

Variants Supported

Variant	Supported
AKD Base	Yes
AKD with Position Indexer	Yes
AKD EtherCAT	Yes
AKD CANopen	Yes
AKD BASIC	Yes
AKD SynqNet	Yes
AKD EtherNet/IP	Yes
AKD Profinet	Yes
AKD sercos [®] III	Yes
AKD-N	No
AKD-C	No

Fieldbus Information

Fieldbus	Index/Subindex	Object Start Version
EtherCAT COE and CANopen CANopen	3493h/0	M_01-00-00-000

Fieldbus	Address	Attributes	Signed?
Profinet	2122	Byte	No
sercos [®] III		2 Octets	

Fieldbus	Index/Subindex	Is 64 bit?	Attributes	Signed?	Object Start Version
Modbus	244	No	8 bit	No	M_01-03-00-000

Description

This parameter sets the direction of the emulated encoder output (EEO). DRV.DIR (pg 319) also effects the output direction (through an XOR, "exclusive or", operation). The drive uses DRV.DIR (pg 319) and DRV.EMUEDIR to decide the direction of the EEO. If DRV.DIR (pg 319) and DRV.EMUEDIR have the same value, then DRV.EMUEDIR is set to 0 (meaning an increase in the motor feedback will result an increase of the EEO and vice-versa). If these parameters have different values, then DRV.EMUEDIR is set to 1 (meaning an increase in the motor feedback will result in a decrease of the EEO and vice-versa).

7.13.21 DRV.EMUEMODE

General Information	
Type	R/W Parameter
Description	Sets the mode of the emulated encoder output (EEO) connector.
Units	N/A
Range	0 to 17
Default Value	0
Data Type	Integer
Start Version	M_01-00-00-000

Variants Supported

Variant	Supported
AKD Base	Yes
AKD with Position Indexer	Yes
AKD EtherCAT	Yes
AKD CANopen	Yes
AKD BASIC	Yes
AKD SynqNet	Yes
AKD EtherNet/IP	Yes
AKD Profinet	Yes
AKD sercos [®] III	Yes
AKD-N	No
AKD-C	No

Fieldbus Information

Fieldbus	Index/Subindex	Object Start Version
EtherCAT COE and CANopen CANopen	3534h/0	M_01-00-00-000

Fieldbus	Address	Attributes	Signed?
Profinet	2123	Word	No
sercos [®] III		2 Octets	

Fieldbus	Index/Subindex	Is 64 bit?	Attributes	Signed?	Object Start Version
Modbus	246	No	16 bit	No	M_01-03-00-000

Description

When the emulated encoder output (EEO) is configured to generate an index pulse (Z pulse) once per rev (DRV.EMUEMODE is 1, 6, or 8) this parameter and DRV.EMUEZOFFSET define the location of the Z pulse. DRV.EMUEZOFFSET defines the position of the Z pulse within one revolution. The pulse is generated each time this position is reached. For example, if this value is set to 32,768 (180 degrees), the Z pulse will be generated at 180 degrees, 540 degrees, 900 degrees, and so on.

When the EEO is configured to generate an absolute index pulse (DRV.EMUEMODE is 2, 7, or 9) this parameter, DRV.,EMUEZOFFSET and DRV.EMUEMTURN define the location of the Z pulse. DRV.EMUEMTURN is used to define which turn of the position range the Z pulse is located.

DRV.EMUEZOFFSET is used to define the position of the Z pulse within one revolution. For example, if DRV.EMUETURN is set to 1, and DRV.EMUEZOFFSET is set to 32,768 (180 degrees), then the index pulse will be generated at position 540 degrees.

When the EEO is configured in pass through mode (DRV.EMUEMODE is 12, 13, or 14) the EEO Z pulse will be generated each time the encoder's physical Z pulse is generated (the physical Z pulse is "passed through").

DRV.EMUEMODE sets the EEO connector to act as either an input or output as follows.

Setting	Function
0 (recommended)	Input (see to select the type of inputs the secondary feedback will accept)
1	EEO Output, A/B with once per rev index
2	EEO Output, A/B with absolute index pulse.
3	Input, A/B signals (Deprecated)
4	Input, step and direction signals (Deprecated)
5	Input, CW/CCW (Cw/Ccw) Signals (Deprecated)
6	Step/Dir with one Z-pulse/rev
7	Step/Dir with one absolute Z-pulse (depends on DRV.EMUEOFFSET and DRV.EMUETURN)
8	CW/CCW output with one Z-pulse/rev
9	CW/CCW output with one absolute Z-pulse (depends on DRV.EMUEOFFSET and DRV.EMUETURN)
10	Allows the X9 connector to be used as a General Purpose I/O or SynqNet fieldbus controlled I/O (See)
11	FB3 Input (Tertiary feedback is reported with FB3.P (pg 465)). Use FB3.MODE (pg 462) to select the feedback type.
12	Output - A/B with index pass through.
13	Output - Step/Dir with index pass through.
14	Output - CW/CCW with index pass through.
15	Output - A/B stepper control.
16	Output - Step/Dir stepper control.
17	Output - CW/CCW stepper control.

Modes 3 to 5 are backwards compatible but deprecated. Refer to FB2.MODE (pg 452) and FB2.SOURCE (pg 459) instead.

NOTE

If you are using multi-turn or single tune absolute feedback devices, and the once per rev or absolute Z pulse modes (DRV.EMUEMODES 1,2,6,7,8, or 9) the Z pulse generated by the EEO will always be aligned with the same mechanical position of the primary feedback position. If you are using an incremental feedback device and these modes, then the origin of the primary feedback is not at the same mechanical position each time the drive powers up. If you are using the pass through mode (DRV.EMUEMODES 12, 13, or 14) the Z pulse generated by the EEO will always be aligned with the same mechanical position of the primary feedback position.

Related Topics

DRV.EMUERES (pg 334), DRV.EMUEZOFFSET (pg 335), DRV.EMUETURN (pg 330)

7.13.22 DRV.EMUEMTURN

General Information	
Type	R/W Parameter
Description	Defines the location of the index pulse on the EEO (emulated encoder output) when DRV.EMUEMODE=2.
Units	revolutions
Range	0 to 4,294,967,295
Default Value	0
Data Type	Integer
Start Version	M_01-00-00-000

Variants Supported

Variant	Supported
AKD Base	Yes
AKD with Position Indexer	Yes
AKD EtherCAT	Yes
AKD CANopen	Yes
AKD BASIC	Yes
AKD SynqNet	Yes
AKD EtherNet/IP	Yes
AKD Profinet	Yes
AKD sercos [®] III	Yes
AKD-N	No
AKD-C	No

Fieldbus Information

Fieldbus	Index/Subindex	Object Start Version
EtherCAT COE and CANopen CANopen	3491h/0	M_01-00-00-000

Fieldbus	Address	Attributes	Signed?
Profinet	2124	DWord	No
sercos [®] III		4 Octets	

Fieldbus	Index/Subindex	Is 64 bit?	Attributes	Signed?	Object Start Version
Modbus	248	No	32 bit	No	M_01-03-00-000

Description

When the emulated encoder output (EEO) is configured to generate an absolute index pulse (DRV.EMUEMODE is 2, 7 or 9) this parameter and DRV.EMUEZOFFSET define the location of the Z pulse. DRV.EMUEMTURN is used to define which turn of the position range the Z pulse is located. DRV.EMUEZOFFSET is used to define the position of the Z pulse within one revolution.

Note: If you are using multi-turn or single tune absolute feedback devices the Z pulse from generated by the EEO will always be aligned with the same mechanical position of the of the primary feedback position. If you are using an incremental feedback device then the origin of the primary feedback is not at the same mechanical position each time the drive powers up.

Related Topics

DRV.EMUEMODE (pg 328), DRV.EMUERES (pg 334)

7.13.23 DRV.EMUEPULSEWIDTH

General Information	
Type	TBD
Description	Sets the encoder output pulse width for modes 6 to 7.
Units	us(microseconds)
Range	4.08 us to 2621.48 us
Default Value	4.08 us
Data Type	Float
Start Version	M_01-00-00-000

Variants Supported

Variant	Supported
AKD Base	Yes
AKD with Position Indexer	Yes
AKD EtherCAT	Yes
AKD CANopen	Yes
AKD BASIC	Yes
AKD SynqNet	Yes
AKD EtherNet/IP	Yes
AKD Profinet	Yes
AKD sercos [®] III	Yes
AKD-N	No
AKD-C	No

Fieldbus Information

Fieldbus	Address	Attributes	Signed?
Profinet	2525	DWord	No
sercos [®] III		4 Octets	

Fieldbus	Index/Subindex	Is 64 bit?	Attributes	Signed?
Modbus	1050	No	32 bit	No

Description

EMU Encoder Out Pulse Width Register

Sets pulse width for CW/CCW and Step and Direction modes. This parameter does not effect the A quad B mode. To calculate emuOutPulseWidth:

$(\text{Desired pulse width} - 40 \text{ nsec}) / 520 \text{ nsec}$

Requirement		DSFPGA-03-306
Bits	Bits	Description
11:0	emuOutPulseWidth	Read/Write 12 bit unsigned number minimum resolution is 520 nsec. Reset state – 0
15:12		reserved

- Register is in counts (12 bit)
- Register * 520ns + 40ns is the actual pulse width.
- Register = 1 = pulse width is 560ns = 0.56us (minimum value)
- For each register increment the pulse width is raised by 0.52us

Example

```
50 usecs pulse width
emuOutPulseWidth = (50 usecs - 40 nsec) / 520 nsec = 96
actual pulse = 96 * 520 nsec + 40 nsec = 49.88 usecs.
```

Related Topics

DRV.EMUEMODE (pg 328)

7.13.24 DRV.EMUERES

General Information	
Type	R/W Parameter
Description	Sets the resolution of the EEO (emulated encoder output).
Units	lines/rev (when DRV.EMUEMODE (pg 328) = 1, 2, or 3) counts/rev (when DRV.EMUEMODE (pg 328) = 4 or 5)
Range	0 to 16,777,215 lines per revolution
Default Value	0 lines per revolution
Data Type	Integer
Start Version	M_01-00-00-000 (resolution increased from 65,535 to 16,777,215 in M_01-04-00-000)

Variants Supported

Variant	Supported
AKD Base	Yes
AKD with Position Indexer	Yes
AKD EtherCAT	Yes
AKD CANopen	Yes
AKD BASIC	Yes
AKD SynqNet	Yes
AKD EtherNet/IP	Yes
AKD Profinet	Yes
AKD sercos [®] III	Yes
AKD-N	No
AKD-C	No

Fieldbus Information

Fieldbus	Index/Subindex	Object Start Version
EtherCAT COE and CANopen CANopen	3535h/0	M_01-00-00-000

Fieldbus	Address	Attributes	Signed?
Profinet	2125	DWord	No
sercos [®] III		4 Octets	

Fieldbus	Index/Subindex	Is 64 bit?	Attributes	Signed?	Object Start Version
Modbus	250	No	32 bit	No	M_01-03-00-000

Description

This parameter sets the emulated encoder (EEO) resolution. DRV.EMUERES also defines how many lines are output for one revolution of the primary feedback (when this port is configured as an output), or how many lines will be considered a full revolution of the handwheel (when this port is configured as an input).

Related Topics

DRV.EMUEMODE (pg 328)

7.13.25 DRV.EMUEZOFFSET

General Information	
Type	R/W Parameter
Description	Sets the location of the EEO (emulated encoder output) index pulse (when DRV.EMUEMODE=1).
Units	1/65536 rev
Range	0 to 65535 rev
Default Value	0 rev
Data Type	Integer
Start Version	M_01-00-00-000

Variants Supported

Variant	Supported
AKD Base	Yes
AKD with Position Indexer	Yes
AKD EtherCAT	Yes
AKD CANopen	Yes
AKD BASIC	Yes
AKD SynqNet	Yes
AKD EtherNet/IP	Yes
AKD Profinet	Yes
AKD sercos [®] III	Yes
AKD-N	No
AKD-C	No

Fieldbus Information

Fieldbus	Index/Subindex	Object Start Version
EtherCAT COE and CANopen CANopen	3537h/0	M_01-00-00-000

Fieldbus	Address	Attributes	Signed?
Profinet	2126	Word	No
sercos [®] III		2 Octets	

Fieldbus	Index/Subindex	Is 64 bit?	Attributes	Signed?	Object Start Version
Modbus	252	No	16 bit	No	M_01-03-00-000

Description

When emulated encoder output (EEO) multiturn is selected (DRV.EMUEMODE (pg 328)=1), this parameter is used by itself to define the position of the Z pulse within one revolution. When the primary feedback position (within a revolution) equals this value, an index pulse will output. Also, if DRV.EMUEMODE=1 then this parameter is used in conjunction with DRV.EMUEMTURN.

When the EEO is configured to generate an absolute index pulse (DRV.EMUEMODE is 2, 7 or 9) this parameter and DRV.EMUEZOFFSET define the location of the Z pulse. DRV.EMUEMTURN is used to

define which turn of the position range the Z pulse is located and DRV.EMUEZOFFSET is used to define the position of the Z pulse within one revolution.

Note: If you are using multi-turn or single turn absolute feedback devices the Z pulse from generated by the EEO will always be aligned with the same mechanical position of the of the primary feedback position. If you are using an incremental feedback device then the origin of the primary feedback is not at the same mechanical position each time the drive powers up.

Related Topics

DRV.EMUEMODE (pg 328), DRV.EMUEMTURN (pg 330)

7.13.26 DRV.EN

General Information	
Type	Command
Description	Enables the axis (software).
Units	N/A
Range	N/A
Default Value	Analog drive software is enabled. All other types of drive software are disabled.
Data Type	N/A
Start Version	M_01-00-00-000

Variants Supported

Variant	Supported
AKD Base	Yes
AKD with Position Indexer	Yes
AKD EtherCAT	Yes
AKD CANopen	Yes
AKD BASIC	Yes
AKD SynqNet	Yes
AKD EtherNet/IP	Yes
AKD Profinet	Yes
AKD sercos [®] III	Yes
AKD-N	Yes
AKD-C	No

Fieldbus Information

Fieldbus	Address	Attributes	Signed?
Profinet sercos [®] III	2127	Command	No

Fieldbus	Index/Subindex	Is 64 bit?	Attributes	Signed?	Object Start Version
Modbus	254	No	Command	No	M_01-03-00-000

Description

DRV.EN issues a software enable to the drive. You can query the value of DRV.ACTIVE (pg 305) to check whether the drive is currently enabled or disabled.

You can also query the value of DRV.DISSOURCES (pg 323) to check whether the software enable bit is high (software enabled was issued by executing DRV.EN) or the software enable bit is low (software disable was issued by executing DRV.DIS). If the drive software enable bit is low and DRV.EN is executed, then drive faults are automatically cleared during the software enable process.

Related Topics

DRV.DIS (pg 320), DRV.DISSOURCES (pg 323), DRV.ACTIVE (pg 305)

7.13.27 DRV.ENDEFAULT

General Information	
Type	R/W Parameter
Description	Sets the default state of the software enable.
Units	N/A
Range	0 to 1
Default Value	0
Data Type	Boolean
Start Version	M_01-00-00-000

Variants Supported

Variant	Supported
AKD Base	Yes
AKD with Position Indexer	Yes
AKD EtherCAT	Yes
AKD CANopen	Yes
AKD BASIC	Yes
AKD SynqNet	Yes
AKD EtherNet/IP	Yes
AKD Profinet	Yes
AKD sercos [®] III	Yes
AKD-N	Yes
AKD-C	No

Fieldbus Information

Fieldbus	Address	Attributes	Signed?
Profinet	2128	Byte	No
sercos [®] III		2 Octets	

Fieldbus	Index/Subindex	Is 64 bit?	Attributes	Signed?	Object Start Version
Modbus	256	No	8 bit	No	M_01-03-00-000

Description

DRV. ENDEFAULT sets the default state of the software enable on power up for drives without field-buses (DRV.CMDSOURCE other than 1).

NOTE

It is recommended to not use this parameter with a BASIC program (keep DRV.ENDEFAULT = 0 / default value). Instead set DRV.SWENABLE = 1 at the beginning of the BASIC program.

7.13.28 DRV.FAULTHIST

General Information	
Type	R/O Parameter
Description	Reads the last 50 faults from NV memory.
Units	N/A
Range	N/A
Default Value	N/A
Data Type	N/A
Start Version	M_01-00-00-000

Variants Supported

Variant	Supported
AKD Base	Yes
AKD with Position Indexer	Yes
AKD EtherCAT	Yes
AKD CANopen	Yes
AKD BASIC	Yes
AKD SynqNet	Yes
AKD EtherNet/IP	Yes
AKD Profinet	Yes
AKD sercos [®] III	Yes
AKD-N	Yes
AKD-C	Yes

Description

DRV.FAULTHIST returns the last 50 faults that occurred in the drive. The faults are shown with their fault number (which matches the one displayed on the drive display) and a time stamp that indicates when they last occurred.

Issue a DRV.CLRFAULTHIST (pg 309) to clear this fault log.

Related Topics

DRV.FAULTS (pg 340), DRV.CLRFAULTHIST (pg 309)

7.13.29 DRV.FAULTS

General Information	
Type	R/O Parameter
Description	Reads the active faults.
Units	N/A
Range	N/A
Default Value	N/A
Data Type	N/A
Start Version	M_01-00-00-000

Variants Supported

Variant	Supported
AKD Base	Yes
AKD with Position Indexer	Yes
AKD EtherCAT	Yes
AKD CANopen	Yes
AKD BASIC	Yes
AKD SynqNet	Yes
AKD EtherNet/IP	Yes
AKD Profinet	Yes
AKD sercos [®] III	Yes
AKD-N	Yes
AKD-C	Yes

Description

DRV.FAULTS returns a list of all currently active faults in the system, preceded by their fault number which matches the number displayed on the drive display.

To clear the faults, either issue a DRV.CLRFAULTS or issue a DRV.DIS followed by DRV.EN.

If no active faults are in the system, then after executing DRV.CLRFAULTS the value read by DRV.FAULTS is "No faults active".

Example

```
-->DRV.FAULTS
502: Bus under voltage.
-->
```

Related Topics

DRV.CLRFAULTS (pg 310), DRV.FAULTHIST (pg 339), DRV.CLRFAULTHIST (pg 309)

7.13.30 DRV.FAULT1 to DRV.FAULT10

General Information	
Type	R/O
Description	Location of fault codes for any active fault conditions.
Units	N/A
Range	Any supported fault code or 0.
Default Value	N/A
Data Type	Integer
Start Version	M_01-06-00-000

Variants Supported

Variant	Supported
AKD Base	Yes
AKD with Position Indexer	Yes
AKD EtherCAT	Yes
AKD CANopen	Yes
AKD BASIC	Yes
AKD SynqNet	Yes
AKD EtherNet/IP	Yes
AKD Profinet	Yes
AKD sercos [®] III	Yes
AKD-N	Yes
AKD-C	Yes

Fieldbus Information

Fieldbus	Index/Subindex	Is 64 bit?	Attributes	Signed?
Modbus	954	No	16 bit	No
	956			
	958			
	960			
	962			
	964			
	966			
	968			
	970			
	972			

Description

These parameters are holding registers where any active faults will be kept. A value of zero represents that no fault is present. Non-zero values correspond to specific fault codes in the drive (see fault and warning messages). The registers are populated in the order of when the fault occurs (DRV.FAULT1, DRV.FAULT2, DRV.FAULT3, and so on).

Notes:

- If DRV.FAULT1 value is 0, then the drive does not have any faults.
- Only active faults are shown. This is not a fault history.
- These registers are an alternative to the string type parameter DRV.FAULTS (pg 340), so that field-busses and AKD BASIC users have easier access to the details of the faults in the drive.
- Warnings are not shown in the registers, only faults.

Related Topics

DRV.ACTIVE (pg 305) | DRV.WARNING1 to DRV.WARNING3 (pg 387)

7.13.31 DRV.HANDWHEEL

General Information	
Type	R/O Parameter
Description	Reads the EEO input value.
Units	1/4,294,967,296 rev
Range	0 to 4,294,967,295 rev
Default Value	0 rev
Data Type	Integer
Start Version	M_01-00-00-000
End Version	M_01-03-00-000

Variants Supported

Variant	Supported
AKD Base	Yes
AKD with Position Indexer	Yes
AKD EtherCAT	Yes
AKD CANopen	Yes
AKD BASIC	Yes
AKD SynqNet	Yes
AKD EtherNet/IP	Yes
AKD Profinet	Yes
AKD sercos [®] III	Yes
AKD-N	No
AKD-C	No

Fieldbus Information

Fieldbus	Index/Subindex	Object Start Version
EtherCAT COE and CANopen CANopen	2050h/0	M_01-00-00-000

Fieldbus	Address	Attributes	Signed?
Profinet	2129	DWord	No
sercos [®] III		4 Octets	

Fieldbus	Index/Subindex	Is 64 bit?	Attributes	Signed?	Object Start Version
Modbus	258	No	32 bit	No	M_01-03-00-000

Description

When the EEO is selected as an input (DRV.EMUEMODE (pg 328)=3,4,5), this parameter reads the EEO value (where 4,294,967,296 is a full revolution, then the value rolls over). DRV.EMUERES (pg 334) defines the how many counts constitute a revolution on the EEO. This parameter represents the feedback 2 positions when feedback 2 is configured to be active.

When secondary feedback is selected (DRV.EMUEMODE is 0 and FB2.SOURCE = 1 (X9), or FB2.SOURCE = 2 (X7)), this parameter represents the secondary feedback position (where

4,294,967,296 is a full revolution, then the value rolls over). FB2.ENCRES defines how many counts define a revolution for the secondary feedback.

Related Topics

DRV.EMUERES (pg 334), DRV.EMUEMODE (pg 328)

7.13.32 DRV.HANDWHEELSRC

General Information	
Type	NV Parameter
Description	Selects the feedback for handwheel operation.
Units	None
Range	2-3
Default Value	2
Data Type	U8
Start Version	M_01-05-08-000

Variants Supported

Variant	Supported
AKD Base	Yes
AKD with Position Indexer	Yes
AKD EtherCAT	Yes
AKD CANopen	Yes
AKD BASIC	Yes
AKD SynqNet	Yes
AKD EtherNet/IP	Yes
AKD Profinet	Yes
AKD sercos [®] III	Yes
AKD-N	No
AKD-C	No

Fieldbus Information

Fieldbus	Address	Attributes	Signed?
Profinet	2611	Byte	No
sercos [®] III		2 Octets	

Fieldbus	Index/Subindex	Is 64 bit?	Attributes	Signed?
Modbus	1224	No	8 bit	No

Description

This command sets the feedback which will be used as the handwheel source. If the selected Feedback is incompatible with the selected emulated encoder mode, a warning will be displayed.

Feedback 3 is only supported on drives with model numbers similar to AKD-x-xxxxx-NBxx-xxxx and will only work with Endat 2.2 multiturn encoder.

7.13.33 DRV.HELP

General Information	
Type	R/O Parameter
Description	Reads the minimum, maximum, and default values for a specific parameter or command.
Units	N/A
Range	N/A
Default Value	N/A
Data Type	N/A
Start Version	M_01-00-00-000

Variants Supported

Variant	Supported
AKD Base	Yes
AKD with Position Indexer	Yes
AKD EtherCAT	Yes
AKD CANopen	Yes
AKD BASIC	Yes
AKD SynqNet	Yes
AKD EtherNet/IP	Yes
AKD Profinet	Yes
AKD sercos [®] III	Yes
AKD-N	Yes
AKD-C	Yes

Description

This parameter returns more information about a specific parameter or command.

In most cases, except special parameters, this command tells you the minimum, maximum, default, and actual value of a parameter. Exceptions are commands that do not have these values (such as DRV.EN (pg 337)) or information commands (such as DRV.VER (pg 384)).

7.13.34 DRV.HELPALL

General Information	
Type	R/O Parameter
Description	Retrieves the minimum, maximum, default, and actual values for all available parameters and commands.
Units	N/A
Range	N/A
Default Value	N/A
Data Type	N/A
Start Version	M_01-00-00-000

Variants Supported

Variant	Supported
AKD Base	Yes
AKD with Position Indexer	Yes
AKD EtherCAT	Yes
AKD CANopen	Yes
AKD BASIC	Yes
AKD SynqNet	Yes
AKD EtherNet/IP	Yes
AKD Profinet	Yes
AKD sercos [®] III	Yes
AKD-N	Yes
AKD-C	Yes

Description

This parameter retrieves all information about all parameters and commands in the firmware. In most cases, DRV.HELPALL returns the minimum, maximum, default, and actual value for each parameter and command. Exceptions include parameters and commands that do not have these values (such as DRV.EN (pg 337)) or pure INFO commands (such as DRV.VER (pg 384)).

7.13.35 DRV.HWENABLE

General Information	
Type	R/O
Description	Status of the hardware enable.
Units	N/A
Range	0 to 1
Default Value	N/A
Data Type	Integer
Start Version	tbd

Variants Supported

Variant	Supported
AKD Base	No
AKD with Position Indexer	No
AKD EtherCAT	No
AKD CANopen	No
AKD BASIC	Yes
AKD SynqNet	No
AKD EtherNet/IP	No
AKD Profinet	No
AKD sercos [®] III	No
AKD-N	No
AKD-C	Yes

Fieldbus Information

Fieldbus	Address	Attributes	Signed?
Profinet	2527	Byte	No
sercos [®] III		2 Octets	

Fieldbus	Index/Subindex	Is 64 bit?	Attributes	Signed?
Modbus	1054	No	8 bit	No

Description

Status of the Hardware Enable.

0 - not enabled

1 - enabled

Notes: This parameter reflects the status of the hardware enable only, not if the status of the power stage. The status of the power stage enable is determined by DRV.ACITVE.

Related Topics

DRV.DISSOURCES (pg 323) | DRV.ACTIVE

7.13.36 DRV.HWENDELAY

General Information	
Type	NV Parameter
Description	Delay time between inactive Hardware Enable input and drive disable.
Units	Milliseconds
Range	0 to 167 ms
Default Value	0 ms
Data Type	Integer
Start Version	01-05-08-000

Variants Supported

Variant	Supported
AKD Base	Yes
AKD with Position Indexer	Yes
AKD EtherCAT	Yes
AKD CANopen	Yes
AKD BASIC	Yes
AKD SynqNet	Yes
AKD EtherNet/IP	Yes
AKD Profinet	Yes
AKD sercos [®] III	Yes
AKD-N	Yes
AKD-C	No

Fieldbus Information

Fieldbus	Address	Attributes	Signed?
Profinet	2612	Byte	No
sercos [®] III		2 Octets	

Fieldbus	Index/Subindex	Is 64 bit?	Attributes	Signed?
Modbus	1222	No	8 bit	No

Description

By default, when the Hardware Disable input deactivates, the drive is immediately disabled. However, on a vertical axis this may allow the load to drop slightly before the brake is applied.

To ensure that the brake is applied before the power stage is disabled, set DRV.HWENDELAY to a value which allows the brake to apply fully.

While the brake is applying, the drive will also attempt to decelerate the motor using the standard drive disable settings such as DRV.DISMODE, CS.DEC, CS.VTHRESH and CS.TO.

NOTE

Prior to version 01-05-08-000, the brake would only apply when velocity dropped below CS.VTHRESH or MOTOR.TBRAKETO expired. Starting with 01-05-08-000, the brake will now apply immediately when the Hardware Enable Input line is deactivated.

7.13.37 DRV.HWENMODE

General Information	
Type	R/W Parameter
Description	Selects the action that the hardware enable digital input will perform.
Units	N/A
Range	0 to 1
Default Value	0
Data Type	Integer
Start Version	M_01-03-00-000

Variants Supported

Variant	Supported
AKD Base	Yes
AKD with Position Indexer	Yes
AKD EtherCAT	Yes
AKD CANopen	Yes
AKD BASIC	Yes
AKD SynqNet	Yes
AKD EtherNet/IP	Yes
AKD Profinet	Yes
AKD sercos [®] III	Yes
AKD-N	Yes
AKD-C	Yes

Fieldbus Information

Fieldbus	Index/Subindex	Object Start Version
EtherCAT COE and CANopen CANopen	3506h/0	M_01-03-00-000

Fieldbus	Address	Attributes	Signed?
Profinet	2130	Byte	No
sercos [®] III		2 Octets	

Fieldbus	Index/Subindex	Is 64 bit?	Attributes	Signed?	Object Start Version
Modbus	260	No	8 bit	No	M_01-03-00-000

Description

This parameter selects the action that the hardware enable digital input will perform.

0 = The rising edge of the hardware enable will clear the drive faults.

1 = The rising edge of the hardware enable will not clear the drive faults.

The high/low state of the hardware enable is always used to control the active enable state of the drive.

7.13.38 DRV.ICONT

General Information	
Type	R/O Parameter
Description	Reads the continuous rated current value.
Units	Arms
Range	N/A
Default Value	N/A
Data Type	Float
Start Version	M_01-00-00-000

Variants Supported

Variant	Supported
AKD Base	Yes
AKD with Position Indexer	Yes
AKD EtherCAT	Yes
AKD CANopen	Yes
AKD BASIC	Yes
AKD SynqNet	Yes
AKD EtherNet/IP	Yes
AKD Profinet	Yes
AKD sercos [®] III	Yes
AKD-N	Yes
AKD-C	Yes

Fieldbus Information

Fieldbus	Address	Attributes	Signed?
Profinet	2131	DWord	Yes
sercos [®] III		4 Octets	

Fieldbus	Index/Subindex	Is 64 bit?	Attributes	Signed?	Object Start Version
Modbus	262	No	32 bit	Yes	M_01-03-00-000

Description

DRV.ICONT returns the drive continuous rated current in Arms.

Related Topics

DRV.IPEAK (pg 355)

7.13.39 DRV.INFO

General Information	
Type	R/O Parameter
Description	Reads general information about the drive.
Units	N/A
Range	N/A
Default Value	N/A
Data Type	String
Start Version	M_01-00-00-000

Variants Supported

Variant	Supported
AKD Base	Yes
AKD with Position Indexer	Yes
AKD EtherCAT	Yes
AKD CANopen	Yes
AKD BASIC	Yes
AKD SynqNet	Yes
AKD EtherNet/IP	Yes
AKD Profinet	Yes
AKD sercos [®] III	Yes
AKD-N	Yes
AKD-C	Yes

Description

DRV.INFO returns general information about the drive.

Example

```
Advanced Kollmorgen Drive
```

```
-----  
---
```

```
Drive model : AKD-P00306-NACC-0000
```

```
Drive type : Position Indexer
```

```
Continuous current : 3.000 Arms
```

```
Peak current: 9.000 Arms
```

```
Voltage : 120/240 VAC
```

```
Option Board : Not applicable
```

```
Connectivity : EtherCAT
```

```
Product serial number: R-0939-00048
```

```
Hardware version : --
```

```
Mac address: 00-23-1B-00-50-F1
```

```
Processor ID: 0xE5040003
```

```
Firmware version: M_01-04-16-000_Z_2011-09-12_14-03-45_AP
```

```
Operational image : M_01-04-16-000_Z_2011-09-12_14-03-45_AP
```

Resident image : R_00-00-28-000
Revision : 19074
Source Location: local

FPGA Version: FP0003_0103_00_00
Operational image : FP0003_0103_00_00
Resident image : FPB003_0100_00_00
Size: 1600

Control board serial number : 4-0921-00196
Part number : 0
Revision : 7
Board ID : Standard

Power board serial number : 4-0922-00156
Part number : 0

TCP/IP IP address : 169.254.250.241
Subnet mask : 255.255.0.0
Default gateway : 0.0.0.0
DHCP server : 0.0.0.0

Temporary fieldbus type : EtherCAT
FPGA size : 1600
Advanced Kollmorgen Drive

Drive model : KC1-B00306-NBAN-0000
Drive type : Base
Continuous current : 3.000 Arms
Peak current : 9.000 Arms
Voltage : 120/240 VAC
Option board : Not applicable
Connectivity : Analog

Product serial number : R-1207-00219
Hardware Version : D
MAC address : 00-23-1B-00-E4-5C
Processor ID : 0xE5040003

Firmware Version : M_01-06-01-000_Z_2012-04-12_15-48-26_TI
Operational image : M_01-06-01-000_Z_2012-04-12_15-48-26_TI
Resident image : R_00-00-37-000
Revision : 30037
Source Location : local
Firmware Build : Standard

FPGA Version : FP0007_0301_00_00
Operational image : FP0007_0301_00_00
Resident image : FPB007_0301_00_00
Size : 45

Control board Serial number : 4-0140-29153
Part number : 105-200500-01 Rev L
Revision : 9
Board ID : Standard

Power board Serial number : 4-0203-35992
Part number : 105-232000-01 Rev K

TCP/IP IP Address : 169.254.250.92
Subnet Mask : 255.255.0.0
Default Gateway : 0.0.0.0
DHCP Server : 0.0.0.0

7.13.40 DRV.IPEAK

General Information	
Type	R/O Parameter
Description	Reads the peak rated current value.
Units	Arms
Range	N/A
Default Value	N/A
Data Type	Float
Start Version	M_01-00-00-000

Variants Supported

Variant	Supported
AKD Base	Yes
AKD with Position Indexer	Yes
AKD EtherCAT	Yes
AKD CANopen	Yes
AKD BASIC	Yes
AKD SynqNet	Yes
AKD EtherNet/IP	Yes
AKD Profinet	Yes
AKD sercos [®] III	Yes
AKD-N	Yes
AKD-C	Yes

Fieldbus Information

Fieldbus	Address	Attributes	Signed?
Profinet	2132	DWord	Yes
sercos [®] III		4 Octets	

Fieldbus	Index/Subindex	Is 64 bit?	Attributes	Signed?	Object Start Version
Modbus	264	No	32 bit	Yes	M_01-03-00-000

Description

DRV.IPEAK returns the drive peak rated current in Arms.

Related Topics

DRV.ICONT (pg 351)

7.13.41 DRV.IZERO

General Information	
Type	NV Parameter
Description	Sets the current that will be used during the DRV.ZERO procedure.
Units	Arms
Range	Drive peak current to 0 Arms
Default Value	0 Arms
Data Type	Float
Start Version	M_01-00-00-000

Variants Supported

Variant	Supported
AKD Base	Yes
AKD with Position Indexer	Yes
AKD EtherCAT	Yes
AKD CANopen	Yes
AKD BASIC	Yes
AKD SynqNet	Yes
AKD EtherNet/IP	Yes
AKD Profinet	Yes
AKD sercos [®] III	Yes
AKD-N	Yes
AKD-C	No

Fieldbus Information

Fieldbus	Address	Attributes	Signed?
Profinet	2133	DWord	No
sercos [®] III		4 Octets	

Fieldbus	Index/Subindex	Is 64 bit?	Attributes	Signed?	Object Start Version
Modbus	266	No	32 bit	No	M_01-03-00-000

Description

This parameter sets the current that is used during the DRV.ZERO (pg 389) procedure.

Related Topics

DRV.ZERO (pg 389)

7.13.42 DRV.LIST

General Information	
Type	R/O Parameter
Description	Reads the list of available parameters and commands.
Units	N/A
Range	N/A
Default Value	N/A
Data Type	String
Start Version	M_01-00-00-000

Variants Supported

Variant	Supported
AKD Base	Yes
AKD with Position Indexer	Yes
AKD EtherCAT	Yes
AKD CANopen	Yes
AKD BASIC	Yes
AKD SynqNet	Yes
AKD EtherNet/IP	Yes
AKD Profinet	Yes
AKD sercos [®] III	Yes
AKD-N	Yes
AKD-C	Yes

Description

DRV.LIST reads the list of available commands and parameters from the drive.

To filter this list, enter DRV.LIST followed by the prefix of the commands and parameters that you wish to display.

Example

Return a list of all available commands in the system:

```
-->DRV.LIST
```

Return all commands with the prefix DRV:

```
-->DRV.LIST DRV
```

7.13.43 DRV.LOGICVOLTS

General Information	
Type	R/O Parameter
Description	Reads the logic voltages.
Units	mv , Ω
Range	N/A
Default Value	N/A
Data Type	String
Start Version	M_01-00-00-000

Variants Supported

Variant	Supported
AKD Base	Yes
AKD with Position Indexer	Yes
AKD EtherCAT	Yes
AKD CANopen	Yes
AKD BASIC	Yes
AKD SynqNet	Yes
AKD EtherNet/IP	Yes
AKD Profinet	Yes
AKD sercos [®] III	Yes
AKD-N	Yes
AKD-C	No

Description

DRV.LOGICVOLTS reads the logic voltages data of 1.2 V, 2.5 V, 3.3 V, 5 V, 12 V, -12 V, and 3.3 AV.

Example

Below is an example of the output for this command:

```

ch0 = 1.2V      : 1211 mv
ch1 = 2.5V      :2488 mv
ch2 = 3.3V      :3274 mv
ch3 = 5V        :4950 mv
ch4 = 12V       :11892 mv
ch5 = -12V      : -11912 mv
ch6 = 3.3AV     :3300 mv
ch7 = R ohm     :100000 ohm

```

7.13.44 DRV.MEMADDR

General Information	
Type	R/W Parameter
Description	Sets the read and write address.
Units	N/A
Range	N/A
Default Value	U8
Data Type	N/A
Start Version	M_01-00-00-000

Variants Supported

Variant	Supported
AKD Base	Yes
AKD with Position Indexer	Yes
AKD EtherCAT	Yes
AKD CANopen	Yes
AKD BASIC	Yes
AKD SynqNet	Yes
AKD EtherNet/IP	Yes
AKD Profinet	Yes
AKD sercos [®] III	Yes
AKD-N	Yes
AKD-C	Yes

Description

DRV.MEMADDR sets the address that is used by DRV.MEMDATA. The input can be either an internal parameter of the drive or any direct address from the DSP address space (SDRAM, internal RAM, or asynchronous memory). The input value can be either decimal or hexadecimal with 0x prefix.

Type extension can be one of the following:

U8,S8,U16,S16,U32,S32,U64,S64.

Examples

Setting to an internal parameter:

```
-->DRV.MEMADDR CCommandHandler.Debug1
```

Setting to an internal address:

```
-->DRV.MEMADDR 0xffabcde.u16
```

Related Topics

DRV.MEMDATA (pg 360)

7.13.45 DRV.MEMDATA

General Information	
Type	R/W Parameter
Description	Sets or reads a value from an internal address.
Units	N/A
Range	N/A
Default Value	N/A
Data Type	N/A
Start Version	M_01-00-00-000

Variants Supported

Variant	Supported
AKD Base	Yes
AKD with Position Indexer	Yes
AKD EtherCAT	Yes
AKD CANopen	Yes
AKD BASIC	Yes
AKD SynqNet	Yes
AKD EtherNet/IP	Yes
AKD Profinet	Yes
AKD sercos [®] III	Yes
AKD-N	Yes
AKD-C	Yes

Description

DRV.MEMDATA reads a value from the address that was set by DRV.MEMADDR (pg 359) or writes a value to this address. The input value can be either decimal or hexadecimal with 0x prefix.

Examples

Read a value from internal address:

```
-->DRV.MEMDATA 01
```

Write a hexadecimal value to an internal address:

```
-->DRV.MEMADDR 0x01
```

Related Topics

DRV.MEMADDR (pg 359)

7.13.46 DRV.MOTIONDISSOURCES

General Information	
Type	R/O Parameter
Description	Returns some causes of a motion disable.
Units	N/A
Range	N/A
Default Value	N/A
Data Type	Integer
Start Version	M_01-10-03-000

Variants Supported

Variant	Supported
AKD Base	Yes
AKD with Position Indexer	Yes
AKD EtherCAT	Yes
AKD CANopen	Yes
AKD BASIC	Yes
AKD SynqNet	Yes
AKD EtherNet/IP	Yes
AKD Profinet	Yes
AKD sercos [®] III	Yes
AKD-N	Yes
AKD-C	Yes

Description

This parameter reports some of the reasons that motion may not be allowed on the axis. There are additional reasons why the drive cannot accept a motion command that are not reported by this command (for example, fieldbus control bits or fault status).

Value	Description
0	Motion not blocked by reason indicated for value 1, 2, or 3.
1	Suspend Motion Active
2	Brake not released
3	Rotor flux not ready

7.13.47 DRV.MOTIONSTAT

General Information	
Type	R/O Parameter
Description	Reads the motion status of the drive.
Units	N/A
Range	0 to 4,294,967,295
Default Value	N/A
Data Type	Integer
Start Version	M_01-00-00-000

Variants Supported

Variant	Supported
AKD Base	Yes
AKD with Position Indexer	Yes
AKD EtherCAT	Yes
AKD CANopen	Yes
AKD BASIC	Yes
AKD SynqNet	Yes
AKD EtherNet/IP	Yes
AKD Profinet	Yes
AKD sercos [®] III	Yes
AKD-N	Yes
AKD-C	No

Fieldbus Information

Fieldbus	Index/Subindex	Object Start Version
EtherCAT COE and CANopen CANopen	3492h/0	M_01-00-00-000

Fieldbus	Address	Attributes	Signed?
Profinet	2134	DWord	No
sercos [®] III		4 Octets	

Fieldbus	Index/Subindex	Is 64 bit?	Attributes	Signed?	Object Start Version
Modbus	268	No	32 bit	No	M_01-03-00-000

Description

This command indicates the current status of the drive internal motion (see table below).

Bit	Significance	Description
0	0x00000001	Motion task is active (high active)
1	0x00000002	Home position found /reference point set (high active)
2	0x00000004	Home routine finished (high active). Bits 1 and 2 both must be set to confirm that the homing process is complete.

Bit	Significance	Description
3	0x00000008	Homing active (high active)
4	0x00000010	Homing error condition has occurred (high active)*
5	0x00000020	Slave in electronic gearing mode synchronized (high active)
6	0x00000040	Electronic gearing is active (high active)
7	0x00000080	Emergency stop procedure in progress (high active)
8	0x00000100	Emergency stop procedure has an error (high active)
9	0x00000200	Service motion active (high active)
10	0x00000400	A motion task could not be activated /invalid MT (high active)**
11	0x00000800	Motion task target position has been reached. See also (high active).
12	0x00001000	Motion task target velocity has been reached. See also (high active).
13	0x00002000	Motion task encountered an exception. A motion task exception can happen during a static motion task activation, or during activation of motion task on the fly (when velocity is not zero). The status bit will be reset automatically on successful activation of any motion, or by a command DRV.CLRFAULT.
14	0x00004000	The target position of a motion task has been crossed. This situation occurs for motion tasks with a change on the fly when triggering the DRV.STOP (pg 378) command just before the reaching the target velocity of the current active motion task. The ramp-down procedure with the motion task deceleration ramp causes the target position to be crossed (high active).
15	0x8000	Drive actual position is within the motion task target position window MT.TPOSWND.
16	0x10000	AKD BASIC trajectory generator is executing a move.
17	0x20000	AKD BASIC trajectory generator has completed a move.

* A possible error condition for homing to a reference switch could be that no reference switch was found between two hardware limit switches.

** A possible error condition for an invalid motion task could be that a motion task tried to trigger automatically following motion task that has never been initialized (called an "empty motion" task).

7.13.48 DRV.NAME

General Information	
Type	NV Parameter
Description	Sets and reads the name of the drive.
Units	N/A
Range	N/A
Default Value	No-Name
Data Type	String
Start Version	M_01-00-00-000

Variants Supported

Variant	Supported
AKD Base	Yes
AKD with Position Indexer	Yes
AKD EtherCAT	Yes
AKD CANopen	Yes
AKD BASIC	Yes
AKD SynqNet	Yes
AKD EtherNet/IP	Yes
AKD Profinet	Yes
AKD sercos [®] III	Yes
AKD-N	Yes
AKD-C	Yes

Description

You can assign a unique name to any drive under the following conditions:

- Only use ASCII characters
- Max length of 10 characters
- No spaces in name

This name is one way to identify the drive in a multiple drive network (for instance, in a TCP/IP network on which multiple drives reside).

From the terminal screen, DRV.NAME returns the name of the drive as ASCII characters.

7.13.49 DRV.NVCHECK

General Information	
Type	R/O Parameter
Description	NV Parameter Checksum
Units	None
Range	N/A
Default Value	N/A
Data Type	Integer
Start Version	M_01-04-12-000

Variants Supported

Variant	Supported
AKD Base	Yes
AKD with Position Indexer	Yes
AKD EtherCAT	Yes
AKD CANopen	Yes
AKD BASIC	Yes
AKD SynqNet	Yes
AKD EtherNet/IP	Yes
AKD Profinet	Yes
AKD sercos [®] III	Yes
AKD-N	Yes
AKD-C	Yes

Fieldbus Information

Fieldbus	Index/Subindex	Is 64 bit?	Attributes	Signed?	Object Start Version
Modbus	1042	Yes	low 32 bit word	No	M_01-04-12-000

Description

DRV.NVCHECK returns a checksum of all the drives NV parameters. This parameter can be used to detect changes in parameters.

In some applications a master device needs to confirm the AKD drive contains an expected set of drive parameters. Reading and checking all the drive parameters individually is viable but this would be a long process involving many reads over the network. DRV.NVCHECK is a checksum on all the NV parameters and this parameter can be read in a single transaction. DRV.NVCHECK will return the same number if all the drive parameters match. If any of the drive parameters are changed then DRV.NVCHECK will return a different value.

Related Topics

DRV.NVLIST (pg 366)

7.13.50 DRV.NVLIST

General Information	
Type	R/O Parameter
Description	Lists the NV parameters and values from the RAM.
Units	N/A
Range	N/A
Default Value	N/A
Data Type	N/A
Start Version	M_01-00-00-000

Variants Supported

Variant	Supported
AKD Base	Yes
AKD with Position Indexer	Yes
AKD EtherCAT	Yes
AKD CANopen	Yes
AKD BASIC	Yes
AKD SynqNet	Yes
AKD EtherNet/IP	Yes
AKD Profinet	Yes
AKD sercos [®] III	Yes
AKD-N	Yes
AKD-C	Yes

Description

DRV.NVLIST lists all the drive parameters that reside in NV memory.

The list includes each parameter name, followed by its current value from the RAM.

7.13.51 DRV.NVLOAD

General Information	
Type	R/O Parameter
Description	Loads all data from the NV memory of the drive into the RAM parameters.
Units	N/A
Range	N/A
Default Value	N/A
Data Type	N/A
Start Version	M_01-00-00-000

Variants Supported

Variant	Supported
AKD Base	Yes
AKD with Position Indexer	Yes
AKD EtherCAT	Yes
AKD CANopen	Yes
AKD BASIC	Yes
AKD SynqNet	Yes
AKD EtherNet/IP	Yes
AKD Profinet	Yes
AKD sercos [®] III	Yes
AKD-N	Yes
AKD-C	Yes

Fieldbus Information

Fieldbus	Address	Attributes	Signed?
Profinet sercos [®] III	2788	Command	No

Fieldbus	Index/Subindex	Is 64 bit?	Attributes	Signed?	Object Start Version
Modbus	1576	No	Command	No	M_01-06-03-000

Description

DRV.NVLOAD loads all data from the NV memory of the drive into the RAM parameters.

Related Topics

DRV.NVLOAD , DRV.NVLIST (pg 366)

7.13.52 DRV.NVSAVE

General Information	
Type	Command
Description	Saves the drive parameters from the RAM to the NV memory.
Units	N/A
Range	N/A
Default Value	N/A
Data Type	N/A
Start Version	M_01-00-00-000

Variants Supported

Variant	Supported
AKD Base	Yes
AKD with Position Indexer	Yes
AKD EtherCAT	Yes
AKD CANopen	Yes
AKD BASIC	Yes
AKD SynqNet	Yes
AKD EtherNet/IP	Yes
AKD Profinet	Yes
AKD sercos [®] III	Yes
AKD-N	Yes
AKD-C	Yes

Fieldbus Information

Fieldbus	Index/Subindex	Object Start Version
EtherCAT COE and CANopen CANopen	1010h/1 35EBh/0	M_01-00-00-000

Fieldbus	Address	Attributes	Signed?
Profinet sercos [®] III	2469	Command	No

Fieldbus	Index/Subindex	Is 64 bit?	Attributes	Signed?
Modbus	938	No	Command	No

Description

DRV.NVSAVE saves the current drive parameter values from the RAM to the NV memory.

The drive parameters that were saved to the NV are read from the NV on the next drive boot, causing the values to be automatically set to the saved values on every drive boot.

Executing DRV.RSTVAR does not modify the values of the NV, but instead sets the drive values in RAM to their defaults.

Related Topics

DRV.RSTVAR (pg 373)

7.13.53 DRV.ONTIME

General Information	
Type	R/O Parameter
Description	Returns how long the drive has been running since last power up.
Units	Days:Hours:Minutes:Seconds
Range	N/A
Default Value	N/A
Data Type	String
Start Version	M_01-00-00-000

Variants Supported

Variant	Supported
AKD Base	Yes
AKD with Position Indexer	Yes
AKD EtherCAT	Yes
AKD CANopen	Yes
AKD BASIC	Yes
AKD SynqNet	Yes
AKD EtherNet/IP	Yes
AKD Profinet	Yes
AKD sercos [®] III	Yes
AKD-N	Yes
AKD-C	Yes

Description

This parameter returns the length of time that the drive has been running for the current session (since the last power up).

Related Topics

Returns how long the drive has been running since first activated. (pg 374)

7.13.54 DRV.OPMODE

General Information	
Type	NV Parameter
Description	Sets the drive operation mode (current, velocity, or position).
Units	N/A
Range	0 to 2
Default Value	0
Data Type	Integer
Start Version	M_01-00-00-000

Variants Supported

Variant	Supported
AKD Base	Yes
AKD with Position Indexer	Yes
AKD EtherCAT	Yes
AKD CANopen	Yes
AKD BASIC	Yes
AKD SynqNet	Yes
AKD EtherNet/IP	Yes
AKD Profinet	Yes
AKD sercos [®] III	Yes
AKD-N	Yes
AKD-C	No

Fieldbus Information

Fieldbus	Index/Subindex	Object Start Version
EtherCAT COE and CANopen CANopen	35B4h/0	M_01-00-00-000

Fieldbus	Address	Attributes	Signed?
Profinet	2135	Byte	No
sercos [®] III		2 Octets	

Fieldbus	Index/Subindex	Is 64 bit?	Attributes	Signed?	Object Start Version
Modbus	270	No	8 bit	No	M_01-03-00-000

Description

DRV.OPMODE specifies the operation mode of the drive. You must also use DRV.COMDSOURCE to set the source of the command to the drive.

The operation mode values can be set as follows:

Mode	Description
0	Current (torque) operation mode
1	Velocity operation mode
2	Position operation mode

DRV.OPMODE can be changed while the drive is enabled or disabled. If you are using the terminal to change the operation mode, then it is recommended that you disable the drive before changing the operation mode. If you change the operation mode from the terminal while the drive is enabled, the system may experience a step change in demand.

Example

Set the source of the command to a TCP/IP channel and the desired operation mode to velocity:

```
-->DRV.CMDSOURCE 0  
-->DRV.OPMODE 1
```

Related Topics

DRV.CMDSOURCE (pg 312)

7.13.55 DRV.READFORMAT

General Information	
Type	R/W Parameter
Description	Sets the value returned to either decimal or hexadecimal.
Units	N/A
Range	10 or 16
Default Value	10
Data Type	Integer
Start Version	M_01-00-00-000

Variants Supported

Variant	Supported
AKD Base	Yes
AKD with Position Indexer	Yes
AKD EtherCAT	Yes
AKD CANopen	Yes
AKD BASIC	Yes
AKD SynqNet	Yes
AKD EtherNet/IP	Yes
AKD Profinet	Yes
AKD sercos [®] III	Yes
AKD-N	Yes
AKD-C	Yes

Fieldbus Information

Description

DRV.READFORMAT sets the return values type to either decimal or hexadecimal.

Format	Description
10	Sets the read values to decimal format
16	Sets the read values to hexadecimal format

7.13.56 DRV.RSTVAR

General Information	
Type	Command
Description	Sets default values in the drive without re-booting the drive and without resetting the NV memory.
Units	N/A
Range	N/A
Default Value	N/A
Data Type	N/A
Start Version	M_01-00-00-000

Variants Supported

Variant	Supported
AKD Base	Yes
AKD with Position Indexer	Yes
AKD EtherCAT	Yes
AKD CANopen	Yes
AKD BASIC	Yes
AKD SynqNet	Yes
AKD EtherNet/IP	Yes
AKD Profinet	Yes
AKD sercos [®] III	Yes
AKD-N	Yes
AKD-C	Yes

Fieldbus Information

Fieldbus	Address	Attributes	Signed?
Profinet sercos [®] III	2136	Command	No

Fieldbus	Index/Subindex	Is 64 bit?	Attributes	Signed?	Object Start Version
Modbus	272	No	Command	No	M_01-03-00-000

Description

DRV.RSTVAR causes the drive to return to the default values without the need to re-boot the drive first and without resetting the NV memory. Use DRV.RSTVAR to return to the default settings and recover a working drive.

7.13.57 DRV.RUNTIME

General Information	
Type	R/O Parameter
Description	Returns how long the drive has been running since first activated.
Units	Days:Hours:Minutes:Seconds
Range	N/A
Default Value	N/A
Data Type	String
Start Version	M_01-00-00-000

Variants Supported

Variant	Supported
AKD Base	Yes
AKD with Position Indexer	Yes
AKD EtherCAT	Yes
AKD CANopen	Yes
AKD BASIC	Yes
AKD SynqNet	Yes
AKD EtherNet/IP	Yes
AKD Profinet	Yes
AKD sercos [®] III	Yes
AKD-N	Yes
AKD-C	Yes

Fieldbus Information

Fieldbus	Index/Subindex	Is 64 bit?	Attributes	Signed?	Object Start Version
Modbus	1578	No		No	M_01-06-03-000

Description

DRV.RUNTIME returns the length of time that the drive has been running since it was first activated. This time includes the current session and the total amount of time from all previous sessions.

7.13.58 DRV.SETUPREQBITS

General Information	
Type	R/O Parameter
Description	Reads the bitwise set status of parameters that must be set before the drive can be enabled.
Units	N/A
Range	N/A
Default Value	N/A
Data Type	N/A
Start Version	M_01-00-00-000

Variants Supported

Variant	Supported
AKD Base	Yes
AKD with Position Indexer	Yes
AKD EtherCAT	Yes
AKD CANopen	Yes
AKD BASIC	Yes
AKD SynqNet	Yes
AKD EtherNet/IP	Yes
AKD Profinet	Yes
AKD sercos [®] III	Yes
AKD-N	Yes
AKD-C	No

Fieldbus Information

Fieldbus	Address	Attributes	Signed?
Profinet	2805	DWord	Yes
sercos [®] III		8 Octets	

Fieldbus	Index/Subindex	Is 64 bit?	Attributes	Signed?	Object Start Version
Modbus	1580	No	32-bits	No	M_01-06-03-000

Description

This parameter returns the bitwise set status of parameters that needs to be set up before the drive can be enabled. The drive can only be enabled when this parameter returns 0.

NOTE

If MOTOR.AUTOSSET (pg 548) is set to 1 (parameters automatically calculated from motor ID data), then all values in the list will be initialized from the feedback device. Otherwise, the parameters must be set manually.

The following table lists the parameters which require setup for each motor type.

Parameter	Bit	Default Value	Linear Per- manent Magnet	Induction Motor V/f Open Loop	Induction Motor Closed Loop	Interior Permanent Magnet	Brush Motor
IL.KP	0	50 [V/A]	√	-	√	√	√
MOTOR.IPEAK	1	2 Arms	√	√	√	√	√
MOTOR.ICONT	2	1 Arms	√	√	√	√	√
MOTOR.POLES	4	6	√	√	√	√	-
MOTOR.LQLL	7	17mH	-	-	-	√	-
MOTOR.LDLL	8	17mH	-	-	-	√	-
MOTOR.KE	9	0	-	-	-	√	-
MOTOR.IMTR	10	100ms	-	-	√	-	-
MOTOR.IMID	11	0	-	-	√	-	-
MOTOR.VOLTRATED	12	230 Vrms	-	√	-	-	-
MOTOR.VRATED	13	0	-	-	-	√	-
MOTOR.LISAT	14	25 x DRIVE.IPEAK	-	-	-	√	-
MOTOR.VRIDK1	15	0	-	-	-	√	-
MOTOR.VRIDK2	16	0	-	-	-	√	-
MOTOR.IDMAX	17	0.5 x MOTOR.IPEAK	-	-	-	√	-
IL.KDPRATIO	18	1	-	-	-	√	-
MOTOR.PITCH	19	32	√	-	-	-	-
MOTOR.VOLTMAX	20	480 Vrms	-	-	-	√	√

Related Topics

DRV.SETUPREQLIST (pg 377), MOTOR.AUTOSSET (pg 548)

7.13.59 DRV.SETUPREQLIST

General Information	
Type	R/O Parameters
Description	Reads the list of parameters that must be set before the drive can be enabled.
Units	N/A
Range	N/A
Default Value	N/A
Data Type	N/A
Start Version	M_01-00-00-000

Variants Supported

Variant	Supported
AKD Base	Yes
AKD with Position Indexer	Yes
AKD EtherCAT	Yes
AKD CANopen	Yes
AKD BASIC	Yes
AKD SynqNet	Yes
AKD EtherNet/IP	Yes
AKD Profinet	Yes
AKD sercos [®] III	Yes
AKD-N	Yes
AKD-C	No

Description

This parameter returns the list of parameters that must be set before the drive can be enabled and also whether or not each one of those parameters is set. This list of parameters will vary depending on the value MOTOR.TYPE. The drive can only be enabled when all commands have a value of 0.

NOTE

If MOTOR.AUTASET (pg 548) is set to 1 (parameters automatically calculated from motor ID data), then all values in the list will be initialized from the feedback device. Otherwise, the parameters must be set manually.

Example

```
-->DRV.SETUPREQLIST
IL.KP 0
MOTOR.ICONT 0
MOTOR.IPEAK 0
MOTOR.POLES 0
-->
```

Related Topics

DRV.SETUPREQBITS (pg 375), MOTOR.AUTASET (pg 548)

7.13.60 DRV.STOP

General Information	
Type	Command
Description	This command stops all drive motion.
Units	N/A
Range	N/A
Default Value	N/A
Data Type	N/A
Start Version	M_01-00-00-000

Variants Supported

Variant	Supported
AKD Base	Yes
AKD with Position Indexer	Yes
AKD EtherCAT	Yes
AKD CANopen	Yes
AKD BASIC	Yes
AKD SynqNet	Yes
AKD EtherNet/IP	Yes
AKD Profinet	Yes
AKD sercos [®] III	Yes
AKD-N	Yes
AKD-C	No

Fieldbus Information

Fieldbus	Index/Subindex	Object Start Version
EtherCAT COE and CANopen CANopen	35FEh/0	M_01-00-00-000

Fieldbus	Address	Attributes	Signed?
Profinet sercos [®] III	2137	Command	No

Fieldbus	Index/Subindex	Is 64 bit?	Attributes	Signed?	Object Start Version
Modbus	274	No	Command	No	M_01-03-00-000

Description

This command stops drive motion. In torque and velocity modes, the command value will immediately be set to 0. In position mode, the axis will decelerate to a full stop. If the position command is from a gearing master, the drive will cancel gearing and decelerate to a stop. This command has no effect if the command source is an analog input (Analog Position, Analog Velocity, or Analog Torque).

If the command values are coming from a fieldbus master, the stop may be immediately overwritten by a new fieldbus command. Use a controlled stop input or disable command to ensure a stop.

7.13.61 DRV.SWENABLE

General Information	
Type	R/W Parameter
Description	Controls whether power can flow to the motor.
Units	none
Range	0 to 1
Default Value	0
Data Type	Integer

Fieldbus	Index/Subindex	Is 64 bit?	Attributes	Signed?	Object Start Version
Modbus	1056	No	8 bit	No	M_01-05-11-000

Description

The following commands disable or enable the drive:

- 0 (disables the drive)
- 1 (enables the drive)

Before power can flow to the motor, the following must all be true:

1. Drive is not faulted.
2. DRV.SWENABLE* input (J4-6) is connected to I/O RTN.
3. DRV.SWENABLE Parameter is set to 1.

Related Topics

DRV.ACTIVE (pg 305)

7.13.62 DRV.TEMPERATURES

General Information	
Type	R/O Parameter
Description	Reads the temperature of drive components.
Units	°C
Range	55 to 125 °C
Default Value	N/A
Data Type	String
Start Version	M_01-00-00-000

Variants Supported

Variant	Supported
AKD Base	Yes
AKD with Position Indexer	Yes
AKD EtherCAT	Yes
AKD CANopen	Yes
AKD BASIC	Yes
AKD SynqNet	Yes
AKD EtherNet/IP	Yes
AKD Profinet	Yes
AKD sercos [®] III	Yes
AKD-N	Yes
AKD-C	Yes

Fieldbus Information

Fieldbus	Index/Subindex	Object Start Version
EtherCAT COE and CANopen CANopen	3610h/0 3611h/0	M_01-00-00-000

Description

DRV.TEMPERATURES reads the temperature in different parts of the drive (power and control boards). The temperature is read from temperature sensors located in the drive.

Example

Below is an example of the output for this command :

```
Control Temperature: 39 °C
Power1 Temperature: 31 °C
Power2 Temperature: Sensor does not exist.
Power3 Temperature: Sensor does not exist.
```

7.13.63 DRV.TIME

General Information	
Type	R/W
Description	A continuous time counter in the drive.
Units	Milliseconds
Range	0 to 4294967295 (~ 49 days)
Default Value	N/A
Data Type	Integer
Start Version	

Variants Supported

Variant	Supported
AKD Base	No
AKD with Position Indexer	No
AKD EtherCAT	No
AKD CANopen	No
AKD BASIC	Yes
AKD SynqNet	No
AKD EtherNet/IP	No
AKD Profinet	No
AKD sercos [®] III	No
AKD-N	No
AKD-C	No

Fieldbus Information

Fieldbus	Address	Attributes	Signed?
Profinet	2529	DWord	No
sercos [®] III		4 Octets	

Fieldbus	Index/Subindex	Is 64 bit?	Attributes	Signed?
Modbus	1058	No	32 bit	No

Description

A continuous time counter in the drive. The timer starts at zero and counts up until it rolls over. If a new value is written to the timer, it continues to count up starting at the written value. The DRV.TIME value is set to zero when the AKD BASIC is powered on.

Related Topics

DRV.RUNTIME (pg 374) | WHEN.DRV.TIME

7.13.64 DRV.TYPE

General Information	
Type	R/W on the CC drive model. R/O on all other drive models.
Description	Selects the operational fieldbus on CC drive models.
Units	N/A
Range	0 to 8
Default Value	2
Data Type	Integer
Start Version	M_01-03-00-000

Variants Supported

Variant	Supported
AKD Base	Yes
AKD with Position Indexer	Yes
AKD EtherCAT	Yes
AKD CANopen	Yes
AKD BASIC	Yes
AKD SynqNet	Yes
AKD EtherNet/IP	Yes
AKD Profinet	Yes
AKD sercos [®] III	Yes
AKD-N	Yes
AKD-C	Yes

Fieldbus Information

Fieldbus	Address	Attributes	Signed?
Profinet	2138	Byte	No
sercos [®] III		2 Octets	

Fieldbus	Index/Subindex	Is 64 bit?	Attributes	Signed?	Object Start Version
Modbus	276	No	8 bit	No	M_01-03-00-000

Description

DRV.TYPE allows you to select the operational fieldbus for your drive. This parameter is read-write on the CC drive models and read-only on all other drive models. To change the operational fieldbus of your drive:

1. Set DRV.TYPE to one of the following values. Only values 0 to 3 are selectable. All other values are read only.

0 = Analog (no EtherCAT or CANopen) with no position indexer functionality.

1 = Analog (no EtherCAT or CANopen) with position indexer functionality.

2 = EtherCAT

3 = CANopen

4 = SynqNet

5 = EtherNet/IP

6 = BASIC Language (not fieldbus)

7 = Profinet
8 = sercos[®] III

2. Save the parameters to the NV memory on the drive by issuing the DRV.NVSAVE command
3. Power cycle the 24 V supply to the drive. When the drive has finished powering up, it will be working with the new selection.

Changing DRV.TYPE does not immediately change the type of the drive fieldbus selection. You must power cycle the drive to start the drive with the selected functionality.

You cannot use EtherCAT and CANopen at the same time. Use FBUS.TYPE or DRV.INFO to identify the fieldbus currently in use.

DRV.TYPE does not change if you use DRV.RSTVAR.

Related Topics

DRV.INFO (pg 352)

7.13.65 DRV.VER

General Information	
Type	R/O Parameter
Description	Reads the drive version.
Units	N/A
Range	N/A
Default Value	N/A
Data Type	String
Start Version	M_01-00-00-000

Variants Supported

Variant	Supported
AKD Base	Yes
AKD with Position Indexer	Yes
AKD EtherCAT	Yes
AKD CANopen	Yes
AKD BASIC	Yes
AKD SynqNet	Yes
AKD EtherNet/IP	Yes
AKD Profinet	Yes
AKD sercos [®] III	Yes
AKD-N	Yes
AKD-C	Yes

Description

DRV.VER reads both FPGA and firmware versions.

The version data presented is hard coded in the firmware code.

Example

Below is an example of the output for this command:

```
Danaher Motion - Digital Servo Drive
-----
FPGA version : FP0004_0001_00_07
Firmware Version : M_0-0-15_T_2009-01-19_10-36-28_IR
```

7.13.66 DRV.VERIMAGE

General Information	
Type	R/O Parameter
Description	Returns the version data from each image.
Units	N/A
Range	N/A
Default Value	N/A
Data Type	String
Start Version	M_01-00-00-000

Variants Supported

Variant	Supported
AKD Base	Yes
AKD with Position Indexer	Yes
AKD EtherCAT	Yes
AKD CANopen	Yes
AKD BASIC	Yes
AKD SynqNet	Yes
AKD EtherNet/IP	Yes
AKD Profinet	Yes
AKD sercos [®] III	Yes
AKD-N	Yes
AKD-C	Yes

Description

DRV.VERIMAGE reads the versions of the different images in the drive. This parameter returns the version data from each image .i00 file.

Example

Below is an example of the output for this parameter:

```
Danaher Motion - Digital Servo Drive
-----
Resident Firmware: R_0-0-11
Operational Firmware: M_0-0-15
Resident FPGA: FPB004_0001_00_07
Operational FPGA : FP0004_0001_00_07
```

7.13.67 DRV.WARNINGS

General Information	
Type	R/O Parameter
Description	Reads the active warnings.
Units	N/A
Range	N/A
Default Value	N/A
Data Type	N/A
Start Version	M_01-00-00-000

Variants Supported

Variant	Supported
AKD Base	Yes
AKD with Position Indexer	Yes
AKD EtherCAT	Yes
AKD CANopen	Yes
AKD BASIC	Yes
AKD SynqNet	Yes
AKD EtherNet/IP	Yes
AKD Profinet	Yes
AKD sercos [®] III	Yes
AKD-N	Yes
AKD-C	Yes

Description

DRV.WARNINGS returns a list of all currently active warnings in the system.

7.13.68 DRV.WARNING1 to DRV.WARNING3

General Information	
Type	R/O
Description	Location of fault codes for any active warning conditions.
Units	N/A
Range	Any supported fault code or 0
Default Value	N/A
Data Type	Integer
Start Version	

Variants Supported

Variant	Supported
AKD Base	Yes
AKD with Position Indexer	Yes
AKD EtherCAT	Yes
AKD CANopen	Yes
AKD BASIC	Yes
AKD SynqNet	Yes
AKD EtherNet/IP	Yes
AKD Profinet	Yes
AKD sercos [®] III	Yes
AKD-N	Yes
AKD-C	Yes

Fieldbus Information

Parameter	Fieldbus	Address	Attributes	Signed?
DRV.WARNING1	Profinet	2791	DWord	No
	sercos [®] III		4 Octets	
DRV.WARNING2	Profinet	2792	DWord	
	sercos [®] III		4 Octets	
DRV.WARNING3	Profinet	2793	DWord	
	sercos [®] III		4 Octets	

Fieldbus	Index/Subindex	Is 64 bit?	Attributes	Signed?
Modbus	1582	No	16 bit	No
	1584			
	1586			

Description

These parameters are holding registers where any active warnings will be displayed. A value of zero represents that no warning is present. Non-zero values correspond to specific warning codes in the drive (see fault and warning messages). The registers are populated in the order of when the warning occurs (DRV.WARNING1, DRV.WARNING2, DRV.WARNING3, and so on).

Notes:

- If DRV.WARNING1 value is 0, then the drive does not have any faults.
- Only active warnings are shown. This is not a warning history.
- These registers are an alternative to the string type parameter DRV.WARNINGS so that fieldbuses and AKD BASIC user programs have integer-type parameters to access to the details of the warnings in the drive.
- Faults are not shown in the registers, only warnings.

Related Topics

DRV.FAULT1 to DRV.FAULT10 (pg 341)

7.13.69 DRV.ZERO

General Information	
Type	R/W Parameter
Description	Sets the zero mode. The procedure is activated when the drive is enabled.
Units	N/A
Range	0 to 1
Default Value	0
Data Type	Integer
Start Version	M_01-00-00-000

Variants Supported

Variant	Supported
AKD Base	Yes
AKD with Position Indexer	Yes
AKD EtherCAT	Yes
AKD CANopen	Yes
AKD BASIC	Yes
AKD SynqNet	Yes
AKD EtherNet/IP	Yes
AKD Profinet	Yes
AKD sercos [®] III	Yes
AKD-N	Yes
AKD-C	No

Fieldbus Information

Fieldbus	Address	Attributes	Signed?
Profinet	2139	Byte	No
sercos [®] III		2 Octets	

Fieldbus	Index/Subindex	Is 64 bit?	Attributes	Signed?	Object Start Version
Modbus	278	No	8 bit	No	M_01-03-00-000

Description

The zero procedure is a sequence in which phase commutation is initialized. During this procedure, the motor is held at a certain known electrical position (by applying a current defined by DRV.IZERO (pg 356)). After the motor rests at this position, the commutation angle is calculated and set automatically.

Related Topics

DRV.IZERO (pg 356)

7.14 EGEAR Parameters

This section describes the EGEAR parameters.

7.14.1 EGEAR.ACCLIMIT	391
7.14.2 EGEAR.DECLIMIT	393
7.14.3 EGEAR.ERROR	395
7.14.4 EGEAR.LOCK	396
7.14.5 EGEAR.ON	397
7.14.6 EGEAR.PULSESIN	398
7.14.7 EGEAR.PULSESOUT	399
7.14.8 EGEAR.RATIO	400
7.14.9 EGEAR.TYPE	401

7.14.1 EGEAR.ACCLIMIT

General Information	
Type	R/W
Description	EGEAR.ACCLIMIT sets the maximum acceleration.
Units	Depends on UNIT.ACCROTARY (pg 713) or UNIT.ACCLINEAR (pg 712) Rotary: rps/s, rpm/s, deg/s ² , (Custom Units)/s ² , rad/s ² Linear: counts/s ² , mm/s ² , μm/s ² , (Custom Units)/s ²
Range	Note: The range and default values of (Custom Units)/s ² units depend on the values of PIN and POUT. The range and default values listed in this table are derived from the default values of PIN and POUT. Rotary: 0.004 to 8,000,000 rps/s 0.224 to 480,000,016.384 rpm/s 1.341 to 2,879,999,967.232 deg/s ² 0.019 to 40,000,000 (Custom Units)/s ² 0.023 to 50,265,481.216 rad/s ² Linear: 16,000,000 to 15,912,994,294,290,448.384 counts/s ² 0.119*MOTOR.PITCH (pg 570) to 256,000,000*MOTOR.PITCH (pg 570) mm/s ² 119.209*MOTOR.PITCH (pg 570) to 255,999,998,951.424*MOTOR.PITCH (pg 570) μm/s ² 0.019 to 40,000,000(Custom Units)/s ²
Default Value	Note: The range and default values of (Custom Units)/s ² units depend on the values of PIN and POUT. The range and default values listed in this table are derived from the default values of PIN and POUT. Rotary: 166.669 rps/s 10,000.170 rpm/s 60,001.016 deg/s ² 833.347 (Custom Units)/s ² 1,047.215 rad/s ² Linear: 715,839,984,631.808 counts/s ² 5,333.424*MOTOR.PITCH (pg 570) mm/s ² 5,333,423.616*MOTOR.PITCH (pg 570) μm/s ² 833.347 (Custom Units)/s ²
Data Type	Integer

Fieldbus Information

Fieldbus	Index/Subindex	Is 64 bit?	Attributes	Signed?
Modbus	1060	Yes	low 32 bit word	No

Description

EGEAR.ACCLIMIT sets the maximum acceleration that will be commanded on the follower when EGEAR.ON is turned ON or the electronic gearing ratio (EGEAR.RATIO or EGEAR.PUSLESOUT / EGEAR.PUSLESIN) is increased. This maximum acceleration limit remains in effect until

EGEAR.LOCK is achieved. Once EGEAR.LOCK is achieved the follower will follow the master with whatever acceleration or deceleration is required.

EGEAR.ACCLIMIT is independent of EGEAR.DECLIMIT. Each variable must be set, independently, to the appropriate value for the desired motion.

Example

```
' This example shows how to use EGEAR.ACCLIMIT to limit
' acceleration and then make up the lost distance.
EGEAR.ACCLIMIT = 10000
EGEAR.RATIO = 1
DRV.SWENABLE = 1
EGEAR.ERROR = 0
EGEAR.TYPE = 0
EGEAR.ON = 1
While EGEAR.LOCK = 0 : wend 'wait for LOCK
MOVE.RELATIVEDIST = EGEAR.ERROR
MOVE.GOREL
```

7.14.2 EGEAR.DECLIMIT

General Information	
Type	R/W
Description	EGEAR.DECLIMIT sets the maximum deceleration that will be commanded on the follower when EGEAR.ON is turned OFF or the electronic gearing ratio (EGEAR.RATIO or EGEAR.PULSESOUT / EGEAR.PUSLESIN) is decreased.
Units	Depends on UNIT.ACCROTARY (pg 713) or UNIT.ACCLINEAR (pg 712) Rotary: rps/s, rpm/s, deg/s ² , (Custom Units)/s ² , rad/s ² Linear: counts/s ² , mm/s ² , μm/s ² , (Custom Units)/s ²
Range	Note: The range and default values of (Custom Units)/s ² units depend on the values of PIN and POUT. The range and default values listed in this table are derived from the default values of PIN and POUT. Rotary: 0.004 to 8,000,000 rps/s 0.224 to 480,000,016.384 rpm/s 1.341 to 2,879,999,967.232 deg/s ² 0.019 to 40,000,000 (Custom Units)/s ² 0.023 to 50,265,481.216 rad/s ² Linear: 16,000,000 to 15,912,994,294,290,448.384 counts/s ² 0.119*MOTOR.PITCH (pg 570) to 256,000,000*MOTOR.PITCH (pg 570) mm/s ² 119.209*MOTOR.PITCH (pg 570) to 255,999,998,951.424*MOTOR.PITCH (pg 570) μm/s ² 0.019 to 40,000,000 (Custom Units)/s ²
Default Value	Note: The range and default values of (Custom Units)/s ² units depend on the values of PIN and POUT. The range and default values listed in this table are derived from the default values of PIN and POUT. Rotary: 166.669 rps/s 10,000.170 rpm/s 60,001.016 deg/s ² 833.347 (Custom Units)/s ² 1047.215 rad/s ² Linear: 715,839,984,631.808 counts/s ² 5,333.424*MOTOR.PITCH (pg 570) mm/s ² 53,33,423.616*MOTOR.PITCH (pg 570) μm/s ² 833.347 (Custom Units)/s ²
Data Type	Integer

Fieldbus Information

Fieldbus	Index/Subindex	Is 64 bit?	Attributes	Signed?
Modbus	1062	Yes	low 32 bit word	No

Description

EGEAR.DECLIMIT sets the maximum deceleration that will be commanded on the follower when EGEAR.ON is turned OFF or the electronic gearing ratio (EGEAR.RATIO or EGEAR.PULSESOUT / EGEAR.PUSLESIN) is decreased. This maximum deceleration limit remains in effect until EGEAR.LOCK is achieved. Once EGEAR.LOCK is achieved the follower will follow the master with whatever acceleration or deceleration is required.

Set EGEAR.DECLIMIT prior to initiating EGEAR.ON.

Related Topics

EGEAR.ACCLIMIT (pg 391) | EGEAR.ERROR (pg 395) | EGEAR.LOCK (pg 396)

7.14.3 EGEAR.ERROR

General Information	
Type	R/W
Description	Indicates the amount of position deviation that has accumulated on the slave axis (in an electronic gearing application) as a result of the slave axis limiting its acceleration or deceleration while achieving velocity synchronization.
Units	Position counts
Range	-140,737,488,355,328 to 140,737,488,355,328
Default Value	0
Data Type	Integer

Fieldbus Information

Fieldbus	Index/Subindex	Is 64 bit?	Attributes	Signed?	Object Start Version
Modbus	1064	Yes	low 32 bit word	No	M_01-05-11-000

Description

EGEAR.ERROR is never automatically set to zero. It accumulates position deviation each time acceleration limiting is activated. Typically, set EGEAR.ERROR to zero before doing something that activates acceleration limiting.

The slave axis' acceleration or deceleration is limited to EGEAR.ACCLIMIT or EGEAR.DECLIMIT whenever:

1. Gearing is turned on or turned off.
2. Ratio is changed.
3. EGEAR.PULSESIN or EGEAR.PULSESOUT is changed.

Example

```
EGEAR.ACCLIMIT = 10000
EGEAR.PULSESIN = 1
EGEAR.PULSESOUT = 1
EGEAR.ERROR = 0
EGEAR.TYPE = 0
EGEAR.ON = 1
While EGEAR.LOCK = 0 : wend
MOVE.RELATIVEDIST = EGEAR.ERROR
MOVE.GOREL 'catch up the position lost while acceleration was being
limited
```

Related Topics

EGEAR.LOCK (pg 396) | EGEAR.ACCLIMIT (pg 391) | EGEAR.DECLIMIT (pg 393)

7.14.4 EGEAR.LOCK

General Information	
Type	R/O
Description	EGEAR.LOCK indicates when the slave axis (follower axis) in an electronic gearing application has achieved velocity synchronization with the electronic gearing master.
Units	None
Range	0 to 1
Default Value	0
Data Type	Integer

Fieldbus Information

Fieldbus	Index/Subindex	Is 64 bit?	Attributes	Signed?	Object Start Version
Modbus	1066	No	8 bit	No	M_01-05-11-000

Description

EGEAR.LOCK indicates when the slave axis (follower axis) in an electronic gearing application has achieved velocity synchronization with the electronic gearing master. EGEAR.ERROR contains the amount of position deviation accumulated while the slave axis was limiting its acceleration or deceleration.

The slave axis' acceleration or deceleration is limited to EGEAR.ACCLIMIT or EGEAR.DECLIMIT whenever:

1. Gearing is turned on or turned off.
2. Ratio is changed.
3. EGEAR.PULSESIN or EGEAR.PULSESOUT is changed.

Example

```
EGEAR.ACCLIMIT = 10000
EGEAR.PULSESIN = 1
EGEAR.PULSESOUT = 1
EGEAR.ERROR = 0
EGEAR.TYPE = 0
EGEAR.ON = 1
While EGEAR.LOCK = 0 : wend
MOVE.RELATIVEDIST = EGEAR.ERROR
MOVE.GOREL 'catch up the position lost while acceleration was being
limited
```

Related Topics

EGEAR.ACCLIMIT (pg 391) | EGEAR.DECLIMIT (pg 393) | EGEAR.ERROR (pg 395)

7.14.5 EGEAR.ON

General Information	
Type	Command
Description	Starts the electronic gearing; active in opmode 2 (position) only.
Units	N/A
Range	0 to 1
Default Value	N/A
Data Type	Integer
Start Version	N/A

Fieldbus Information

Fieldbus	Index/Subindex	Is 64 bit?	Attributes	Signed?	Object Start Version
Modbus	1068	No	8 bit	No	M_01-05-11-000

Description

The command EGEAR.ON starts the electronic gearing procedure according to the selected electronic gearing mode:

Mode	Description
0	Gearing Off
1	Gearing On

7.14.6 EGEAR.PULSESIN

General Information	
Type	R/W
Description	Specifies the number of encoder counts used when specifying an exact electronic gearing ratio.
Units	Motor revolutions / Encoder Revolution
Range	0 to 65,535
Default Value	1
Data Type	Integer

Fieldbus Information

Fieldbus	Index/Subindex	Is 64 bit?	Attributes	Signed?	Object Start Version
Modbus	1070	No	16 bit	No	M_01-05-11-000

Description

EGEAR.PULSESIN is the number of encoder counts the motor moves for each EGEAR.PULSESOUT number of position counts. EGEAR.PULSESIN must be set more recently than EGEAR.RATIO in order to use exact electronic gearing.

Related Topics

MOVE.MOVING (pg 604) | EGEAR.ON (pg 397) | FB2.SOURCE (pg 459) | FB2.ENCREC (pg 451) | FB2.MODE (pg 452)

7.14.7 EGEAR.PULSESOUT

General Information	
Type	R/W
Description	Specifies the number of position counts used in an exact electronic gearing ratio.
Units	Position counts
Range	-32,768 to 32,767
Default Value	1
Data Type	Integer

Fieldbus Information

Fieldbus	Index/Subindex	Is 64 bit?	Attributes	Signed?	Object Start Version
Modbus	1072	No	8 bit	Yes	M_01-05-11-000

Description

EGEAR.PULSESOUT is the number of position counts the motor moves for each EGEAR.PULSESIN number of encoder counts. EGEAR.PULSESOUT must be set more recently than EGEAR.RATIO in order to use exact electronic gearing.

Related Topics

EGEAR.PULSESIN (pg 398) | EGEAR.RATIO (pg 400) | EGEAR.ON (pg 397) | FB2.SOURCE (pg 459) | FB2.ENCREAS (pg 451) | FB2.MODE (pg 452)

7.14.8 EGEAR.RATIO

General Information	
Type	TBD
Description	Sets the electronic gearing ratio (rev to rev) between the encoder shaft (master) and the motor shaft (slave).
Units	Motor revolutions / Encoder Revolution
Range	-2,000 to 2,000
Default Value	1
Data Type	Float

Fieldbus Information

Fieldbus	Index/Subindex	Is 64 bit?	Attributes	Signed?	Object Start Version
Modbus	1074	No	32 bit	No	M_01-05-11-000

Description

Ratio must be set more recently than EGEAR.PULSESIN or EGEAR.PULSESOUT in order to use EGEAR.RATIO to control electronic gearing.

Related Topics

EGEAR.ON (pg 397) | EGEAR.PULSESIN (pg 398) | EGEAR.PULSESOUT (pg 399) | FB2.SOURCE (pg 459) | FB2.ENCRESES (pg 451) | FB2.MODE (pg 452)

7.14.9 EGEAR.TYPE

General Information	
Type	R/W
Description	Sets the allowed direction of motion for electronic gearing.
Units	N/A
Range	0 to 2
Default Value	0
Data Type	Integer
Start Version	TBD

Fieldbus Information

Fieldbus	Index/Subindex	Is 64 bit?	Attributes	Signed?	Object Start Version
Modbus	1076	No	8 bit	No	M_01-05-11-000

Description

EGEAR.TYPE sets allowed direction of motion for electronic gearing:

- 0 - Both directions
- 1 - Positive direction
- 2 - Negative direction

NOTE

EGEAR.TYPE cannot be changed on the fly. EGEAR.TYPE is considered only when Gearing is turned on (EGEAR = 1).

When unidirectional gearing is used (EGEAR.TYPE = 1 or 2) then motion in the allowed direction occurs only when the master encoder returns to the point at which it originally reversed direction. Other motion commands, such as MOVE.GOVEL or MOVE.GOREL, may be executed while gearing is active. These moves will be superimposed (added to) on the motion caused by electronic gearing.

Related Topics

EGEAR.ON (pg 397)

7.15 EXTENCODER Parameters

This section describes the EXTENCODER parameters.

7.15.1 EXTENCODER.FREQ	403
7.15.2 EXTENCODER.POSITION	404
7.15.3 EXTENCODER.POSMODULO	405

7.15.1 EXTENCODER.FREQ

General Information	
Type	R/O
Description	Gets the external encoder (EEO) velocity.
Units	Hz
Range	-2^{63} to $+2^{63} - 1$
Default Value	0 Counts
Data Type	Float

Fieldbus Information

Fieldbus	Index/Subindex	Is 64 bit?	Attributes	Signed?	Object Start Version
Modbus	1078	No	32 bit	No	M_01-05-11-000

Description

Gets the external encoder (EEO) velocity.

7.15.2 EXTENCODER.POSITION

General Information	
Type	R/W
Description	Gets the external encoder (EEO) position.
Units	$1/(2^{64})$
Range	-2^{63} to $+2^{63} - 1$ OR 0 to EXTENCODER.POSMODULO
Default Value	0 Counts
Data Type	Integer

Fieldbus Information

Fieldbus	Index/Subindex	Is 64 bit?	Attributes	Signed?	Object Start Version
Modbus	1080	Yes	64 bit	Yes	M_01-05-11-000

Description

Gets the external encoder (EEO) position.

7.15.3 EXTENCODER.POSMODULO

General Information	
Type	R/W
Description	Sets/gets the external encoder (EEO) modulo position.
Units	1/(2 ⁶⁴)
Range	0 to +2 ⁶⁴ - 1
Default Value	0 Counts (off)
Data Type	Integer

Fieldbus Information

Fieldbus	Index/Subindex	Is 64 bit?	Attributes	Signed?	Object Start Version
Modbus	1084	Yes	64 bit	No	M_01-05-11-000

Description

Sets/gets the external encoder (EEO) modulo position.

7.16 FAULT Parameters

This section describes the FAULT parameters.

7.16.1 FAULTx.ACTION	407
-----------------------------------	------------

7.16.1 FAULTx.ACTION

General Information	
Type	R/W
Description	Gets/Sets the Fault Action for Fault 130, 131, 132, 134, 139, 451, and 702.
Units	N/A
Range	0 to 1
Default Value	0
Data Type	Integer
Start Version	M_01-04-16-000

Variants Supported

Variant	Supported
AKD Base	Yes
AKD with Position Indexer	Yes
AKD EtherCAT	Yes
AKD CANopen	Yes
AKD BASIC	Yes
AKD SynqNet	Yes
AKD EtherNet/IP	Yes
AKD Profinet	Yes
AKD sercos [®] III	Yes
AKD-N	Yes
AKD-C	No

Fieldbus Information

Parameter	Fieldbus	Address	Attributes	Signed?
FAULT130.ACTION	Profinet	2601	Byte	No
	sercos [®] III		2 Octets	
FAULT132.ACTION	Profinet	2602	Byte	
	sercos [®] III		2 Octets	
FAULT130.ACTION	Profinet	2603	Byte	
	sercos [®] III		2 Octets	
FAULT132.ACTION	Profinet	2604	Byte	
	sercos [®] III		2 Octets	
FAULT139.ACTION	Profinet	2797	Byte	
	sercos [®] III		2 Octets	
FAULT451.ACTION	Profinet	2615	Byte	
	sercos [®] III		2 Octets	
FAULT702.ACTION	Profinet	2605	Byte	
	sercos [®] III		2 Octets	

Fieldbus	Index/Subindex	Is 64 bit?	Attributes	Signed?
Modbus	1202	No	8 bit	No
	1204			
	1206			
	1208			
	1594			
	1210			
	1230			

Description

This Parameter determines the action the drive should take when Fault 130, 131, 132, 134, 139, 451, or 702 occurs.

Parameter Value	Drive Action
0	Disable Amplifier
1	Ignore (fault will not be reported)

7.17 FB1 Parameters

This section describes the FB1 parameters.

7.17.1 FB1.BISSBITS	410
7.17.2 FB1.ENCREC	411
7.17.3 FB1.HALLSTATE	413
7.17.4 FB1.HALLSTATEU	415
7.17.5 FB1.HALLSTATEV	416
7.17.6 FB1.HALLSTATEW	417
7.17.7 FB1.IDENTIFIED	418
7.17.8 FB1.INITSIGNED	420
7.17.9 FB1.LASTIDENTIFIED	421
7.17.10 FB1.MECHPOS	422
7.17.11 FB1.MEMVER	423
7.17.12 FB1.MOTORPHASE	424
7.17.13 FB1.MOTORPOLES	425
7.17.14 FB1.OFFSET	426
7.17.15 FB1.ORIGIN	428
7.17.16 FB1.P	430
7.17.17 FB1.PDIR	431
7.17.18 FB1.PFIND	432
7.17.19 FB1.PFINDCMDU	433
7.17.20 FB1.POFFSET	434
7.17.21 FB1.POLES	435
7.17.22 FB1.PSCALE	436
7.17.23 FB1.PUNIT	438
7.17.24 FB1.RESKTR	439
7.17.25 FB1.RESREFPHASE	440
7.17.26 FB1.SELECT	441
7.17.27 FB1.TRACKINGCAL	443
7.17.28 FB1.USERBYTE0 to FB1.USERBYTE7	444
7.17.29 FB1.USERDWORD0 to FB1.USERDWORD1	446
7.17.30 FB1.USERWORD0 to FB1.USERWORD3	448

7.17.1 FB1.BISSBITS

General Information	
Type	NV Parameter
Description	Specifies the number of Biss Sensor (Position) Bits for the BiSS Mode C encoder in use.
Units	bits
Range	0 to 64 bits
Default Value	32 bits
Data Type	Integer
See Also	FB1.SELECT (pg 441), FB1.IDENTIFIED (pg 418)
Start Version	M_01-01-00-100 and M_01-01-03-000

Variants Supported

Variant	Supported
AKD Base	Yes
AKD with Position Indexer	Yes
AKD EtherCAT	Yes
AKD CANopen	Yes
AKD BASIC	Yes
AKD SynqNet	Yes
AKD EtherNet/IP	Yes
AKD Profinet	Yes
AKD sercos [®] III	Yes
AKD-N	Yes
AKD-C	No

Fieldbus Information

Fieldbus	Address	Attributes	Signed?
Profinet	2140	Byte	No
sercos [®] III		2 Octets	

Fieldbus	Index/Subindex	Is 64 bit?	Attributes	Signed?	Object Start Version
Modbus	280	No	8 bit	No	M_01-03-00-000

Description

FB1.BISSBITS specifies the number of BiSS sensor (position) bits for the BiSS Mode C encoder in use. Typically the value is either 26 or 32 for a BiSS Mode C Renishaw encoder. The required value for this parameter is provided by the feedback device manufacturer for the particular device being used.

7.17.2 FB1.ENCRES

General Information	
Type	Depends on FB1.IDENTIFIED. See table in description below.
Description	Sets the resolution of the motor encoder.
Units	Encoder counts
Range	0 to $2^{32}-1$
Default Value	1,024
Data Type	Integer
See Also	N/A
Start Version	M_01-00-00-000

Variants Supported

Variant	Supported
AKD Base	Yes
AKD with Position Indexer	Yes
AKD EtherCAT	Yes
AKD CANopen	Yes
AKD BASIC	Yes
AKD SynqNet	Yes
AKD EtherNet/IP	Yes
AKD Profinet	Yes
AKD sercos [®] III	Yes
AKD-N	Yes
AKD-C	No

Fieldbus Information

Fieldbus	Index/Subindex	Object Start Version
EtherCAT COE and CANopen CANopen	3533h/0	M_01-00-00-000

Fieldbus	Address	Attributes	Signed?
Profinet	2141	DWord	No
sercos [®] III		4 Octets	

Fieldbus	Index/Subindex	Is 64 bit?	Attributes	Signed?	Object Start Version
Modbus	282	No	32 bit	No	M_01-03-00-000

Description

This parameter sets or gets the resolution of the motor encoder (encoder feedback systems only) in number of counts per revolution for a rotary motor and the number of encoder pitches per motor pole pitch for a linear motor. The number of encoder counts per revolution is obtained by multiplying the motor catalog resolution in units of PPR by four. For example, for a 1024 PPR resolution motor, the number of encoder counts per revolution is $1024 \times 4 = 4096$. For this motor FB1.ENCRES must be set to 4096.

For linear motors, the value of FB1.ENCRES is set to the number of encoder pitches per motor pole pitch. For a motor with 32 mm pole pitch, and a 40 µm encoder pitch, the value for FB1.ENCRES should be set to $32 \text{ mm} / 40 \text{ µm} = 800$.

Depending on the value of FB1.IDENTIFIED, FB1.ENCRES changes between read-only and read-write. The following table lists the FB1.IDENTIFIED values and FB1.ENCRES's corresponding type.

FB1.IDENTIFIED value	FB1.ENCRES type
10 (Incremental encoder)	R/W
11 (Incremental encoder, no halls)	R/W
20 (Sine encoder)	R/W
21 (Sine encoder, no halls)	R/W
30 (Endat 2.1)	R/O
31 (Endat 2.2)	R/O
32 (biSS)	R/O
33 (hiperface)	R/O
34 (biSS Mode C)	R/W
40 (Resolver)	R/W
41 (sfd)	R/O
42 (Tamagawa)	R/O

7.17.3 FB1.HALLSTATE

General Information	
Type	R/O Parameter
Description	Reads the Hall switch values (encoder feedback only).
Units	Terminal: Binary Scope: N/A
Range	Terminal: 0 0 0 to 1 1 1 Scope: 0 to 7
Default Value	N/A
Data Type	Terminal: String Scope: Integer
Start Version	M_01-00-00-000

AKD BASIC Information	
Data Type	Integer

Variants Supported

Variant	Supported
AKD Base	Yes
AKD with Position Indexer	Yes
AKD EtherCAT	Yes
AKD CANopen	Yes
AKD BASIC	Yes
AKD SynqNet	Yes
AKD EtherNet/IP	Yes
AKD Profinet	Yes
AKD sercos [®] III	Yes
AKD-N	Yes
AKD-C	No

Description

FB1.HALLSTATE reads the Hall switch values (encoder feedback only).

Terminal:

When called from the terminal, FB1.HALLSTATE will return three numbers from 0 0 0 to 1 1 1, where:

- Hall U = Digit 1
- Hall V = Digit 2
- Hall W = Digit 3

0 is a low voltage state, and 1 is a high voltage state on the hall effect.

Scope:

When viewing FB1.HALLSTATE from the scope screen, the result is a single integer. This integer is the sum of the three hall bit states, where $FB1.HALLSTATE = Hall\ U + Hall\ V + Hall\ W$. If the hall is not active, it will return 0. When a hall is active, each hall will contribute the following value to the sum:

- Hall U = 1
- Hall V = 2
- Hall W = 4

Value	Hall U	Hall V	Hall W
0	-	-	-
1	√	-	-
2	-	√	-
3	√	√	-
4	-	-	√
5	√	-	√
6	-	√	√
7	√	√	√

The following sequences indicate the direction of rotation.

Sequence	Direction
1,5,4,6,2,3,1	Positive
1,3,2,6,4,5,1	Negative

7.17.4 FB1.HALLSTATEU

General Information	
Type	R/O Parameter
Description	Reads the state of Hall switch U.
Units	N/A
Range	0 and 1
Default Value	1
Data Type	Integer
See Also	FB1.HALLSTATE (pg 413)
Start Version	M_01-03-07-000

Variants Supported

Variant	Supported
AKD Base	Yes
AKD with Position Indexer	Yes
AKD EtherCAT	Yes
AKD CANopen	Yes
AKD BASIC	Yes
AKD SynqNet	Yes
AKD EtherNet/IP	Yes
AKD Profinet	Yes
AKD sercos [®] III	Yes
AKD-N	Yes
AKD-C	No

Fieldbus Information

Fieldbus	Address	Attributes	Signed?
Profinet	2466	Byte	No
sercos [®] III		2 Octets	

Fieldbus	Index/Subindex	Is 64 bit?	Attributes	Signed?
Modbus	932	No	8 bit	No

Description

FB1.HALLSTATEU reads the state of Hall switch U.

7.17.5 FB1.HALLSTATEV

General Information	
Type	R/O Parameter
Description	Reads the state of Hall switch V.
Units	N/A
Range	0 and 1
Default Value	1
Data Type	Integer
See Also	FB1.HALLSTATE (pg 413)
Start Version	M_01-03-07-000

Variants Supported

Variant	Supported
AKD Base	Yes
AKD with Position Indexer	Yes
AKD EtherCAT	Yes
AKD CANopen	Yes
AKD BASIC	Yes
AKD SynqNet	Yes
AKD EtherNet/IP	Yes
AKD Profinet	Yes
AKD sercos [®] III	Yes
AKD-N	Yes
AKD-C	No

Fieldbus Information

Fieldbus	Address	Attributes	Signed?
Profinet	2467	Byte	No
sercos [®] III		2 Octets	

Fieldbus	Index/Subindex	Is 64 bit?	Attributes	Signed?
Modbus	934	No	8 bit	No

Description

FB1.HALLSTATEV reads the state of Hall switch V.

7.17.6 FB1.HALLSTATEW

General Information	
Type	R/O Parameter
Description	Reads the state of Hall switch W.
Units	N/A
Range	0 and 1
Default Value	1
Data Type	Integer
See Also	FB1.HALLSTATE (pg 413)
Start Version	M_01-03-07-000

Variants Supported

Variant	Supported
AKD Base	Yes
AKD with Position Indexer	Yes
AKD EtherCAT	Yes
AKD CANopen	Yes
AKD BASIC	Yes
AKD SynqNet	Yes
AKD EtherNet/IP	Yes
AKD Profinet	Yes
AKD sercos [®] III	Yes
AKD-N	Yes
AKD-C	No

Fieldbus Information

Fieldbus	Address	Attributes	Signed?
Profinet	2468	Byte	No
sercos [®] III		2 Octets	

Fieldbus	Index/Subindex	Is 64 bit?	Attributes	Signed?
Modbus	936	No	8 bit	No

Description

FB1.HALLSTATEW reads the state of Hall switch W.

7.17.7 FB1.IDENTIFIED

General Information	
Type	R/O Parameter
Description	Reads the type of feedback device used by the drive/-motor.
Units	N/A
Range	N/A
Default Value	N/A
Data Type	Integer
See Also	FB1.SELECT
Start Version	M_01-00-00-000

Variants Supported

Variant	Supported
AKD Base	Yes
AKD with Position Indexer	Yes
AKD EtherCAT	Yes
AKD CANopen	Yes
AKD BASIC	Yes
AKD SynqNet	Yes
AKD EtherNet/IP	Yes
AKD Profinet	Yes
AKD sercos [®] III	Yes
AKD-N	Yes
AKD-C	No

Fieldbus Information

Fieldbus	Address	Attributes	Signed?
Profinet	2142	Byte	No
sercos [®] III		2 Octets	

Fieldbus	Index/Subindex	Is 64 bit?	Attributes	Signed?	Object Start Version
Modbus	284	No	8 bit	No	M_01-03-00-000

Description

This parameter is set according to FB1.SELECT on drive power up if FB1.SELECT is not -1; otherwise the parameter value is read from the drive memory.

Type	Description
0	Unknown
1	No encoder
10	Incremental encoder with A/B Quad, marker pulse and Hall
11	Incremental encoder with A/B Quad, marker pulse and no Hall
20	Sine Encoder , with marker pulse and Hall

Type	Description
21	Sine encoder , with marker pulse & No Halls
30	EnDat 2.1 with Sine Cosine
31	EnDat 2.2
32	BiSS with Sine Cosine
33	HIPERFACE
34	BiSS Mode C Renishaw
40	Resolver
41	SFD (Smart Feedback Device)
42	Tamagawa
43	Network Cyclic Feedback
44	FB2 Cyclic Feedback
45	SFD3
46	Hiperface DSL
50	Reserved

7.17.8 FB1.INITSIGNED

General Information	
Type	NV Parameter
Description	Sets initial feedback value as signed or unsigned.
Units	N/A
Range	0 to 1
Default Value	1
Data Type	Integer
See Also	FB1.ORIGIN
Start Version	M_01-00-00-000

Variants Supported

Variant	Supported
AKD Base	Yes
AKD with Position Indexer	Yes
AKD EtherCAT	Yes
AKD CANopen	Yes
AKD BASIC	Yes
AKD SynqNet	Yes
AKD EtherNet/IP	Yes
AKD Profinet	Yes
AKD sercos [®] III	Yes
AKD-N	Yes
AKD-C	No

Fieldbus Information

Fieldbus	Address	Attributes	Signed?
Profinet	2143	Byte	Yes
sercos [®] III		2 Octets	

Fieldbus	Index/Subindex	Is 64 bit?	Attributes	Signed?	Object Start Version
Modbus	286	No	8 bit	Yes	M_01-03-00-000

Description

This parameter sets whether the initial value of the feedback read from the feedback device will be set as a signed or as an unsigned value.

0 = Unsigned

1 = Signed

The drive internal process for the feedback initialization is as follows:

1. Reads the position feedback.
2. Adds the origin to the feedback.
3. Determines modulo from Step 2 by the actual feedback bits.
4. Sets the position feedback sign according to FB1.INITSIGNED.

7.17.9 FB1.LASTIDENTIFIED

General Information	
Type	NV Parameter
Description	Stores the feedback type auto-detected during the last feedback initialization. Auto-detection will look for this type first.
Units	N/A
Range	30 (EnDat 2.1), 32 (BiSS with Sine Cosine), 33 (HIPERFACE), 41 (SFD), 45 (SFD3)
Default Value	41 (SFD)
Data Type	Integer
Start Version	M_01-10-01-000

Variants Supported

Variant	Supported
AKD Base	Yes
AKD with Position Indexer	Yes
AKD EtherCAT	Yes
AKD CANopen	Yes
AKD BASIC	Yes
AKD SynqNet	Yes
AKD EtherNet/IP	Yes
AKD Profinet	Yes
AKD sercos [®] III	Yes
AKD-N	Yes
AKD-C	No

Description

If FB1.SELECT (pg 441) is set to -1, AKD automatically detects the feedback device. When auto-detection is successful, the identified feedback type is stored in FB1.LASTIDENTIFIED. On the next feedback initialization, the auto-detection algorithm will first look for the last identified type, speeding up feedback initialization and shortening drive boot time.

The time to automatically identify the device is shortened when FB1.LASTIDENTIFIED is already set to the correct feedback type.

Note that this parameter must be saved to non-volatile memory with DRV.NVSAVE (pg 368) in order to take effect each time the drive powers up.

7.17.10 FB1.MECHPOS

General Information	
Type	R/O Parameter
Description	Reads the mechanical position.
Units	counts
Range	0 to 4,294,967,295 counts
Default Value	N/A
Data Type	Integer
See Also	N/A
Start Version	M_01-00-00-000

Variants Supported

Variant	Supported
AKD Base	Yes
AKD with Position Indexer	Yes
AKD EtherCAT	Yes
AKD CANopen	Yes
AKD BASIC	Yes
AKD SynqNet	Yes
AKD EtherNet/IP	Yes
AKD Profinet	Yes
AKD sercos [®] III	Yes
AKD-N	Yes
AKD-C	No

Fieldbus Information

Fieldbus	Address	Attributes	Signed?
Profinet	2144	DWord	No
sercos [®] III		4 Octets	

Fieldbus	Index/Subindex	Is 64 bit?	Attributes	Signed?	Object Start Version
Modbus	288	No	32 bit	No	M_01-03-00-000

Description

FB1.MECHPOS reads the mechanical angle which is equal to the lower 32 bits in the 64-bit position feedback word.

7.17.11 FB1.MEMVER

General Information	
Type	R/O Parameter
Description	Returns the memory feedback version.
Units	N/A
Range	N/A
Default Value	N/A
Data Type	Integer
See Also	N/A
Start Version	M_01-00-00-000

Variants Supported

Variant	Supported
AKD Base	Yes
AKD with Position Indexer	Yes
AKD EtherCAT	Yes
AKD CANopen	Yes
AKD BASIC	Yes
AKD SynqNet	Yes
AKD EtherNet/IP	Yes
AKD Profinet	Yes
AKD sercos [®] III	Yes
AKD-N	Yes
AKD-C	No

Description

FB1.MEMVER returns the memory feedback version (only applicable for feedbacks with memory).

7.17.12 FB1.MOTORPHASE

General Information	
Type	NV Parameter
Description	Sets the motor phase of the motor associated with FB1.
Units	Electrical degrees
Range	0 to 359
Default Value	0
Data Type	Integer
Start Version	M_01-11-04-000

Variants Supported

Variant	Supported
AKD Base	Yes
AKD with Position Indexer	Yes
AKD EtherCAT	Yes
AKD CANopen	Yes
AKD BASIC	Yes
AKD SynqNet	Yes
AKD EtherNet/IP	Yes
AKD Profinet	Yes
AKD sercos [®] III	Yes
AKD-N	Yes
AKD-C	No

Description

This parameter sets the phase offset for commutation of the motor associated with FB1. When multiple motors are driven by a single AKD, this allows different motor configurations to be saved for each value of IL.FBSOURCE (→ p. 1).

When IL.FBSOURCE is set to 0, the value of FB1.MOTORPHASE will overwrite the value of MOTOR.PHASE (pg 567). Additionally, while IL.FBSOURCE = 0, a write to MOTOR.PHASE will also overwrite FB1.MOTORPHASE.

7.17.13 FB1.MOTORPOLES

General Information	
Type	NV Parameter
Description	Sets the number of motor poles associated with FB1.
Units	N/A
Range	0 to 510
Default Value	0
Data Type	Integer
Start Version	M_01-11-04-000

Variants Supported

Variant	Supported
AKD Base	Yes
AKD with Position Indexer	Yes
AKD EtherCAT	Yes
AKD CANopen	Yes
AKD BASIC	Yes
AKD SynqNet	Yes
AKD EtherNet/IP	Yes
AKD Profinet	Yes
AKD sercos [®] III	Yes
AKD-N	Yes
AKD-C	No

Description

This parameter sets the number of motor poles associated with FB1. When multiple motors are driven by a single AKD, this allows different motor configurations to be saved for each value of IL.FBSOURCE (→ p. 1).

When IL.FBSOURCE is set to 0, the value of FB1.MOTORPOLES will overwrite the current value of MOTOR.POLES (pg 571). Additionally, while IL.FBSOURCE = 0, a write to MOTOR.POLES will also overwrite FB1.MOTORPOLES.

7.17.14 FB1.OFFSET

General Information	
Type	NV-Parameter
Description	Sets position feedback offset.
Units	Depends on UNIT.ACCROTARY or UNIT.PLINEAR Rotary: counts, rad, deg, Custom Units 16-bit counts Linear: counts, mm, μ m, Custom Units 16-bit counts
Range	Rotary: -5,123,372,000,000,005.000 to 5,123,372,000,000,005.000 counts -7495.067 to 7495.067 rad -429,436.096 to 429,436.096 deg -5,964.390 to 5,964.390 [Custom Units] -78,176,452.637 to 78,176,452.636 16-bit counts Linear: -5,123,372,000,000,005.000 to 5,123,372,000,000,005.000 counts -1192.878*MOTOR.PITCH (pg 570) to 1192.878*MOTOR.PITCH mm -1192877.952*MOTOR.PITCH to 1192877.952*MOTOR.PITCH μ m -5964.390 to 5964.390 Custom Units -78176452.637 to 78176452.636 16-bit counts
Default Value	0
Data Type	Float
Start Version	M_01-00-00-000

Variants Supported

Variant	Supported
AKD Base	Yes
AKD with Position Indexer	Yes
AKD EtherCAT	Yes
AKD CANopen	Yes
AKD BASIC	Yes
AKD SynqNet	Yes
AKD EtherNet/IP	Yes
AKD Profinet	Yes
AKD sercos [®] III	Yes
AKD-N	Yes
AKD-C	No

Fieldbus Information

Fieldbus	Index/Subindex	Object Start Version
EtherCAT COE and CANopen	3533h/0	M_01-00-00-000

Fieldbus	Address	Attributes	Signed?
Profinet	2145	DWord	Yes
sercos [®] III		8 Octets	

Fieldbus	Index/Subindex	Is 64 bit?	Attributes	Signed?	Object Start Version
Modbus	290	Yes	64-bits	Yes	M_01-06-03-000

Description

FB1.OFFSET is a value added to the position feedback (PL.FB (pg 621)).

Example

If PL.FB is 10 deg and FB1.OFFSET is set to -10 deg, then the next read of PL.FB will return ~0 deg.

Related Topics

PL.FB (pg 621)

7.17.15 FB1.ORIGIN

General Information	
Type	NV Parameter
Description	Adds to the initial feedback position.
Units	Depends on UNIT.PROTARY (pg 718) or UNIT.PLINEAR (pg 716) Rotary: counts, rad, deg, custom units, 16-bit counts Linear: counts, mm, µm, custom units, 16-bit counts
Range	Rotary: 0.000 to 5,123,372,000,000.000 counts 0.000 to 7,495.067 rad 0.000 to 429,436.096 deg 0.000 to 5,964.390 custom units 0.000 to 78,176,452.636 16-bit counts Linear: 0.000 to 5,123,372,000,000.000 counts 0.000 to 1,192.878 mm 0.000 to 1,192,877.952 µm 0.000 to 5,964.390 custom units 0.000 to 78,176,452.636 counts 16 Bit
Default Value	0 counts
Data Type	Float
See Also	FB1.INITSIGNED
Start Version	M_01-00-00-000

Variants Supported

Variant	Supported
AKD Base	Yes
AKD with Position Indexer	Yes
AKD EtherCAT	Yes
AKD CANopen	Yes
AKD BASIC	Yes
AKD SynqNet	Yes
AKD EtherNet/IP	Yes
AKD Profinet	Yes
AKD sercos [®] III	Yes
AKD-N	Yes
AKD-C	No

Fieldbus Information

Fieldbus	Index/Subindex	Object Start Version
EtherCAT COE and CANopen CANopen	3656h/0	M_01-00-00-000

Fieldbus	Address	Attributes	Signed?
Profinet	2147	DWord	No
sercos [®] III		8 Octets	

Fieldbus	Index/Subindex	Is 64 bit?	Attributes	Signed?	Object Start Version
Modbus	294	Yes	64 bit	No	M_01-03-00-000

Description

FB1.ORIGIN is a value that is added to the feedback device position.

If the modulo is disabled (PL.MODPEN (pg 636) is set to disabled), then the origin is added to the position feedback.

Initial position value = (<feedback from device> + FB1.ORIGIN)

However, if modulo is enabled (PL.MODPEN is set to enabled) then the modulo is applied to both the feedback device position and the origin value.

The modulo value is defined by PL.MODP1 (pg 630) and PL.MODP2 (pg 632)

Initial position value = (<feedback from device> + FB1.ORIGIN) modulo

The drive internal process for the feedback initialization is as follows:

1. Reads the position feedback.
2. Adds the origin to the feedback.
3. Determines modulo from Step 2 by the actual feedback bits.
4. Sets the position feedback sign according to FB1.INITSIGNED (pg 420).

Example

This example assumes that the drive is connected to a single turn feedback device with memory.

FB1.ORIGIN is set to 22 degrees and saved into NV memory.

Drive boots and reads from feedback device position 340 degrees. According to the description section above, calculation will be:

With PL.MODPEN disabled:

Initial feed back will be set to 366 degrees.

$(340 + 22) = 366$ degrees.

With PL.MODPEN enabled:

Initial feedback will be set to 2 degrees.

PL.MODP1 = 0

PL.MODP2 = 360

$(340 + 22) \text{ modulo } 360 = 2$ degrees.

7.17.16 FB1.P

General Information	
Type	R/O Parameter
Description	Reads position from the primary feedback.
Units	Depends on FB1.PUNIT (pg 438) counts or custom units.
Range	N/A
Default Value	N/A
Data Type	S64
Start Version	M_01-05-08-000

Variants Supported

Variant	Supported
AKD Base	Yes
AKD with Position Indexer	Yes
AKD EtherCAT	Yes
AKD CANopen	Yes
AKD BASIC	Yes
AKD SynqNet	Yes
AKD EtherNet/IP	Yes
AKD Profinet	Yes
AKD sercos [®] III	Yes
AKD-N	Yes
AKD-C	No

Fieldbus Information

Fieldbus	Index/Subindex	Is 64 bit?	Attributes	Signed?	Object Start Version
Modbus	1610	Yes	64-bits	Yes	M_01-06-03-000

Description

This parameter reads the position of the primary feedback device connected to X10. The position can be read as counts or in custom units. This is the raw position read back from the device. The output format is 32:32, the upper 32 bits represent the multi-turns and the lower 32 bits represent the position of the feedback.

7.17.17 FB1.PDIR

General Information	
Type	NV-Parameter
Description	Sets the counting direction for feedback channel 1.
Units	None
Range	0 to 1
Default Value	0
Data Type	U8
See Also	N/A
Start Version	M_01-05-11-000

Variants Supported

Variant	Supported
AKD Base	Yes
AKD with Position Indexer	Yes
AKD EtherCAT	Yes
AKD CANopen	Yes
AKD BASIC	Yes
AKD SynqNet	Yes
AKD EtherNet/IP	Yes
AKD Profinet	Yes
AKD sercos [®] III	Yes
AKD-N	Yes
AKD-C	No

Fieldbus Information

Fieldbus	Address	Attributes	Signed?
Profinet	2807	Byte	No
sercos [®] III		2 Octets	

Fieldbus	Index/Subindex	Is 64 bit?	Attributes	Signed?	Object Start Version
Modbus	1614	No	8-bits	No	M_01-06-03-000

Description

FB1.PDIR will change the sign and with it the direction of feedback channel 1.

Example

If position feedback = 35,185.932 counts and you set:

→ FB1.PDIR 1

then position feedback = -35,185.932 counts

7.17.18 FB1.PFIND

General Information	
Type	R/W Parameter
Description	A procedure that allows the user to find the commutation angle for encoder feedback, which has no halls.
Units	NA
Range	0, 1
Default Value	0
Data Type	Integer
See Also	FB1.PFINDCMDU (pg 433)
Start Version	M_01-00-00-000

Variants Supported

Variant	Supported
AKD Base	Yes
AKD with Position Indexer	Yes
AKD EtherCAT	Yes
AKD CANopen	Yes
AKD BASIC	Yes
AKD SynqNet	Yes
AKD EtherNet/IP	Yes
AKD Profinet	Yes
AKD sercos [®] III	Yes
AKD-N	Yes
AKD-C	No

Fieldbus Information

Fieldbus	Address	Attributes	Signed?
Profinet	2149	Byte	No
sercos [®] III		2 Octets	

Fieldbus	Index/Subindex	Is 64 bit?	Attributes	Signed?	Object Start Version
Modbus	298	No	8 bit	No	M_01-03-00-000

Description

A procedure that allows the user to find the commutation angle for encoder feedback (which has no Halls).

7.17.19 FB1.PFINDCMDU

General Information	
Type	R/W Parameter
Description	Current value used during the phase finding procedure (PFB.PFIND=1)
Units	A
Range	0 to DRV.IPEAK
Default Value	0
Data Type	Float
See Also	PFB.PFIND
Start Version	M_01-00-00-000

Variants Supported

Variant	Supported
AKD Base	Yes
AKD with Position Indexer	Yes
AKD EtherCAT	Yes
AKD CANopen	Yes
AKD BASIC	Yes
AKD SynqNet	Yes
AKD EtherNet/IP	Yes
AKD Profinet	Yes
AKD sercos [®] III	Yes
AKD-N	Yes
AKD-C	No

Fieldbus Information

Fieldbus	Address	Attributes	Signed?
Profinet	2150	DWord	No
sercos [®] III		4 Octets	

Fieldbus	Index/Subindex	Is 64 bit?	Attributes	Signed?	Object Start Version
Modbus	300	No	32 bit	No	M_01-03-00-000

Description

FB1.PFINDCMDU sets the current value used during the phase finding procedure.

7.17.20 FB1.POFFSET

General Information	
Type	NV-Parameter
Description	Sets the offset for primary feedback.
Units	counts, custom units
Range	-5,123,372,000,000,005.000 to 5,123,372,000,000,005.000 counts or -10,485,760.000 to 10,485,760.000 custom units
Default Value	0
Data Type	S64
See Also	N/A
Start Version	M_01-05-11-000

Variants Supported

Variant	Supported
AKD Base	Yes
AKD with Position Indexer	Yes
AKD EtherCAT	Yes
AKD CANopen	Yes
AKD BASIC	Yes
AKD SynqNet	Yes
AKD EtherNet/IP	Yes
AKD Profinet	Yes
AKD sercos [®] III	Yes
AKD-N	Yes
AKD-C	No

Fieldbus Information

Fieldbus	Address	Attributes	Signed?
Profinet	2809	DWord	Yes
sercos [®] III		8 Octets	

Fieldbus	Index/Subindex	Is 64 bit?	Attributes	Signed?	Object Start Version
Modbus	1618	Yes	64-bits	Yes	M_01-06-03-000

Description

FB1.POFFSET is the value added to the primary feedback position (FB1.P (pg 430)).

Example

If FB1.P is 10000 counts and FB1.POFFSET is set to -10000 counts, then the next read of FB1.P will return ~0 counts.

7.17.21 FB1.POLES

General Information	
Type	R/W Parameter
Description	Reads the number of feedback poles.
Units	N/A
Range	2 to 128
Default Value	2
Data Type	Integer
See Also	MOTOR.POLES
Start Version	M_01-00-00-000

Variants Supported

Variant	Supported
AKD Base	Yes
AKD with Position Indexer	Yes
AKD EtherCAT	Yes
AKD CANopen	Yes
AKD BASIC	Yes
AKD SynqNet	Yes
AKD EtherNet/IP	Yes
AKD Profinet	Yes
AKD sercos [®] III	Yes
AKD-N	Yes
AKD-C	No

Fieldbus Information

Fieldbus	Address	Attributes	Signed?
Profinet	2151	Word	No
sercos [®] III		2 Octets	

Fieldbus	Index/Subindex	Is 64 bit?	Attributes	Signed?	Object Start Version
Modbus	302	No	16 bit	No	M_01-03-00-000

Description

FB1.POLES sets the number of individual poles in the feedback device. This variable is used for the commutation function, as well as for velocity feedback scaling, and represents the number of individual poles (not pole pairs). The division value of motor poles (MOTOR.POLES) and feedback poles (FB1.POLES) must be an integer when moving drive to enable, otherwise a fault is issued.

7.17.22 FB1.PSCALE

General Information	
Type	R/W Parameter
Description	Sets position scaling value for fieldbus transferred position objects.
Units	N/A
Range	0 to 32
Default Value	20
Data Type	Integer
See Also	N/A
Start Version	M_01-00-00-000

Variants Supported

Variant	Supported
AKD Base	Yes
AKD with Position Indexer	Yes
AKD EtherCAT	Yes
AKD CANopen	Yes
AKD BASIC	Yes
AKD SynqNet	Yes
AKD EtherNet/IP	Yes
AKD Profinet	Yes
AKD sercos [®] III	Yes
AKD-N	Yes
AKD-C	No

Fieldbus Information

Fieldbus	Address	Attributes	Signed?
Profinet	2152	Byte	No
sercos [®] III		2 Octets	

Fieldbus	Index/Subindex	Is 64 bit?	Attributes	Signed?	Object Start Version
Modbus	304	No	8 bit	No	M_01-03-00-000

Description

Position values transferred over fieldbus are converted from native 64-bit values to a maximum 32-bit position value. This parameter sets the resolution/revolution of position values back to the controller.

FB1.PSCALE determines the counts per revolution of position values delivered by fieldbus. The default value is 20, which yields 2^{20} counts/revolution. This scaling is used for CAN PDOs 6064 (Position Actual Value) and 60F4 (Following Error Actual Value).

Example

The drive always works internally with 64-bit position values. The drive internal 64-bit actual position should contain the following value:

0x0000.0023.1234.ABCD

The lower 32 bits represent the mechanical angle of the feedback. The upper 32 bits represent the number of turns.

FB1.PSCALE = 20

The 32-bit position is: 0x0231234A

FB1.PSCALE = 16

The 32-bit position is: 0x00231234

7.17.23 FB1.PUNIT

General Information	
Type	NV Parameter
Description	Sets the unit for FB1.P.
Units	N/A
Range	0, 3
Default Value	0
Data Type	U8
See Also	N/A
Start Version	M_01-05-11-000

Variants Supported

Variant	Supported
AKD Base	Yes
AKD with Position Indexer	Yes
AKD EtherCAT	Yes
AKD CANopen	Yes
AKD BASIC	Yes
AKD SynqNet	Yes
AKD EtherNet/IP	Yes
AKD Profinet	Yes
AKD sercos [®] III	Yes
AKD-N	Yes
AKD-C	No

Fieldbus Information

Fieldbus	Address	Attributes	Signed?
Profinet	2812	DWord	No
sercos [®] III		4 Octets	

Fieldbus	Index/Subindex	Is 64 bit?	Attributes	Signed?	Object Start Version
Modbus	1624	No	32-bits	No	M_01-06-03-000

Description

FB1.PUNIT sets the position unit for FB1.P.

Value	Description
0	Counts (32.32 format)
3	(FB1.PIN/FB1.POUT) per revolution.

Related Topics

FB1.P (pg 430)

7.17.24 FB1.RESKTR

General Information	
Type	NV Parameter
Description	Sets the resolver nominal transformation ratio.
Units	N/A
Range	0.001 to 50.000
Default Value	0.5
Data Type	Float
See Also	N/A
Start Version	M_01-00-00-000

Variants Supported

Variant	Supported
AKD Base	Yes
AKD with Position Indexer	Yes
AKD EtherCAT	Yes
AKD CANopen	Yes
AKD BASIC	Yes
AKD SynqNet	Yes
AKD EtherNet/IP	Yes
AKD Profinet	Yes
AKD sercos [®] III	Yes
AKD-N	Yes
AKD-C	No

Fieldbus Information

Fieldbus	Address	Attributes	Signed?
Profinet	2153	Word	No
sercos [®] III		2 Octets	

Fieldbus	Index/Subindex	Is 64 bit?	Attributes	Signed?	Object Start Version
Modbus	306	No	16 bit	No	M_01-03-00-000

Description

This parameter sets the resolver nominal transformation ratio. It affects the resolver excitation output amplitude.

The value can be obtained from the resolver data sheet.

7.17.25 FB1.RESREFPHASE

General Information	
Type	NV Parameter
Description	Sets the electrical degrees of phase lag in the resolver.
Units	electrical degrees
Range	-180 to 180°
Default Value	-2°
Data Type	Float
See Also	N/A
Start Version	M_01-00-00-000

Variants Supported

Variant	Supported
AKD Base	Yes
AKD with Position Indexer	Yes
AKD EtherCAT	Yes
AKD CANopen	Yes
AKD BASIC	Yes
AKD SynqNet	Yes
AKD EtherNet/IP	Yes
AKD Profinet	Yes
AKD sercos [®] III	Yes
AKD-N	Yes
AKD-C	No

Fieldbus Information

Fieldbus	Address	Attributes	Signed?
Profinet	2154	DWord	Yes
sercos [®] III		4 Octets	

Fieldbus	Index/Subindex	Is 64 bit?	Attributes	Signed?	Object Start Version
Modbus	308	No	32 bit	Yes	M_01-03-00-000

Description

This parameter sets the electrical degrees of phase lag in the resolver.
See the motor resolver datasheet for the value for this parameter .

7.17.26 FB1.SELECT

General Information	
Type	NV Parameter
Description	Sets user entered type or identified type (-1).
Units	N/A
Range	-1, 1, 10, 11, 20, 21, 30, 31, 32, 33, 34, 40, 41, 42, 43, 45, 46, 50
Default Value	-1
Data Type	Integer
Start Version	M_01-00-00-000

Variants Supported

Variant	Supported
AKD Base	Yes
AKD with Position Indexer	Yes
AKD EtherCAT	Yes
AKD CANopen	Yes
AKD BASIC	Yes
AKD SynqNet	Yes
AKD EtherNet/IP	Yes
AKD Profinet	Yes
AKD sercos [®] III	Yes
AKD-N	Yes
AKD-C	No

Fieldbus Information

Fieldbus	Index/Subindex	Object Start Version
EtherCAT COE and CANopen CANopen	353Bh/0	M_01-00-00-000

Fieldbus	Address	Attributes	Signed?
Profinet	2155	Byte	Yes
sercos [®] III		2 Octets	

Fieldbus	Index/Subindex	Is 64 bit?	Attributes	Signed?	Object Start Version
Modbus	310	No	8 bit	Yes	M_01-03-00-000

Description

FB1.SELECT sets the feedback type manually (see FB1.IDENTIFIED) or allows the drive to automatically identify the feedback type on power up.

FB1 5V Power Supply Notes:

If FB1.SELECT = -1, the 5V power supply will only turn on during the initialization phase. If the feedback type cannot be automatically detected, the 5V power supply will be turned off, and remain off until a DRV.CLRFAULTS is issued (which will re-start the FB1 initialization), or FB1.SELECT is manually set to a specific feedback type.

When FB1.SELECT is manually set to a specific feedback type, the FB1 5V power supply will remain on, unless a short is detected. This is useful for encoder types that may require calibration.

FB1.SELECT Input Values

Changing these input values will manually set the value of FB1.IDENTIFIED (pg 418).

NOTE

If the feedback setting fails, FB1.IDENTIFIED is automatically set to 0 (no feedback identified).

Input Value	Description
-1	The drive automatically identifies the type of feedback as part of the power up process. Setting this value does not modify FB1.IDENTIFIED, unless it is saved in the NV memory for the next power up. If a feedback with memory is connected to the drive, the value of FB1.IDENTIFIED is set automatically to the feedback identified and all parameters read from the feedback are set according to the values read from the feedback. If no feedback is connected or a feedback with no memory is connected, the value of FB1.IDENTIFIED is set to 0 (no feedback identified) and all values normally read from the feedback are read from NV memory (if stored in NV) otherwise they are set to the default values.
0	Unknown. No feedback identified.
1	Manually sets the type to No Encoder. This setting can be used if no feedback device is connected to the X10 connector. This may be the case if FB2 or FB3 is used for position or velocity control.
10	Manually sets the type to Incremental encoder with A/B Quad, marker pulse and Hall.
11	Manually sets the type to Incremental encoder with A/B Quad, marker pulse and no Hall.
20	Manually sets the type to Sine Encoder, with marker pulse and Hall.
21	Manually sets the type to Sine encoder, with marker pulse & No Halls.
30	Manually sets the type to Endat 2.1 with Sine Cosine.
31	Manually sets the type to Endat 2.2.
32	Manually sets the type to BiSS (Analog) with Sine Cosine.
33	Manually sets the type to Hiperface. Note that all Hiperface feedback types are supported by the AKD. This includes SEL/SEK 37, SEL/SEK 52, SKM/SKS 36, SRS/SRM 50, SRS/SRM 60, SEK 90, SEK160, and SEK 260. The AKD drive will support any new Hiperface device, since any new device will be released with a label type of 0xFF. Devices with this label type have all of the pertinent information to configure these devices (number of single turn bits, number of multi-turn bits, and number of sine/cosine periods) stored in their memory. The AKD is able to read this information, and automatically configure the drive for proper operation. Note that the devices SEK 90, SEK 160, and SEK 260 are label type 0xFF.
34	Manually sets the type to BiSS Mode C, Renishaw.
40	Manually sets the type to Resolver.
41	Manually sets the type to SFD (Smart Feedback Device).
42	Manually sets the type to Tamagawa.
43	Manually sets the type to use Cyclic Feedback from the Motion Network.
45	Manually sets the type to SFD3. This value is only supported on model numbers AKD-xyyzz-NBxx. This value is only supported for firmware version 01-11-00-000 and later.
46	Manually sets the type to Hiperface DSL. This value is only supported on model numbers AKD-xyyzz-NBxx. This value is only supported for firmware versions 01-09-00-000 and later. An external dongle between the two wires from the DSL to the X10 connector is required to use Hiperface DSL.
50	This value is reserved and should not be used.

7.17.27 FB1.TRACKINGCAL

General Information	
Type	NV Parameter
Description	Controls tracking calibration algorithm.
Units	N/A
Range	0 to 1
Default Value	0
Data Type	Integer
See Also	N/A
Start Version	M_01-00-00-000

Variants Supported

Variant	Supported
AKD Base	Yes
AKD with Position Indexer	Yes
AKD EtherCAT	Yes
AKD CANopen	Yes
AKD BASIC	Yes
AKD SynqNet	Yes
AKD EtherNet/IP	Yes
AKD Profinet	Yes
AKD sercos [®] III	Yes
AKD-N	Yes
AKD-C	No

Fieldbus Information

Fieldbus	Address	Attributes	Signed?
Profinet	2156	Byte	No
sercos [®] III		2 Octets	

Fieldbus	Index/Subindex	Is 64 bit?	Attributes	Signed?	Object Start Version
Modbus	312	No	8 bit	No	M_01-03-00-000

Description

This parameter turns the tracking calibration algorithm on or off for sine-cosine or resolver.

0 = Tracking calibration is off.

1 = Tracking calibration is on.

7.17.28 FB1.USERBYTE0 to FB1.USERBYTE7

General Information	
Type	R/W
Description	Reads and writes data stored in two 32 bit words in the Endat feedback device.
Units	N/A
Range	0 to 255
Default Value	0
Data Type	Integer
Start Version	M_01-05-08-000

Variants Supported

Variant	Supported
AKD Base	Yes
AKD with Position Indexer	Yes
AKD EtherCAT	Yes
AKD CANopen	Yes
AKD BASIC	Yes
AKD SynqNet	Yes
AKD EtherNet/IP	Yes
AKD Profinet	Yes
AKD sercos [®] III	Yes
AKD-N	Yes
AKD-C	No

Fieldbus Information

Fieldbus	Address	Attributes	Signed?
Profinet	2813	Byte	No
sercos [®] III		2 Octets	

Description

FB1.USERBYTE, FB1.USERWORD, and FB1.USERDWORD share two 32bit words in the Endat feedback device. These three parameters offer different ways to store and access the data stored in these two 32bit words. The table below defines each parameters function. The values are automatically stored non-volatile in the feedback device.

Parameter	Bits	Attributes
FB1.USERBYTE0 to FB1.USERBYTE7	8 bit	signed or unsigned char
FB1.USERWORD0 to FB1.USERWORD3	16 bit	signed or unsigned short
FB1.USERDWORD0 to FB1.USERDWORD1	32 bit	singed or unsigned int

The parameters overlap each other in the following way:

BYTE0	BYTE1	BYTE2	BYTE3	BYTE4	BYTE5	BYTE6	BYT7
WORD0		WORD1		WORD2		WORD3	
DWORD0				DWORD1			

For example, if BYTE1 is modified, WORD0 and DWORD0 are modified as well.

Example

```
-->FB1.USERDWORD1 65536
-->FB1.USERBYTE1
0
-->FB1.USERBYTE2
1
-->FB1.USERBYTE3
0

-->FB1.USERBYTE3 1 (write to the highest byte of FB1.USERDWORD0)
-->FB1.USERDWORD0
16842752
-->FB1.USERWORD0
0
-->FB1.USERWORD1
257
```

7.17.29 FB1.USERDWORD0 to FB1.USERDWORD1

General Information	
Type	R/W
Description	Reads and writes data stored in two 32 bit words in the Endat feedback device.
Units	N/A
Range	0 to 4,294,967,295
Default Value	0
Data Type	Integer
Start Version	M_01-05-08-000

Variants Supported

Variant	Supported
AKD Base	Yes
AKD with Position Indexer	Yes
AKD EtherCAT	Yes
AKD CANopen	Yes
AKD BASIC	Yes
AKD SynqNet	Yes
AKD EtherNet/IP	Yes
AKD Profinet	Yes
AKD sercos [®] III	Yes
AKD-N	Yes
AKD-C	No

Fieldbus Information

Fieldbus	Address	Attributes	Signed?
Profinet	2814	DWord	No
sercos [®] III		4 Octets	

Description

FB1.USERBYTE, FB1.USERWORD, and FB1.USERDWORD share two 32bit words in the Endat feedback device. These three parameters offer different ways to store and access the data stored in these two 32bit words. The table below defines each parameters function. The values are automatically stored non-volatile in the feedback device.

Parameter	Bits	Attributes
FB1.USERBYTE0 to FB1.USERBYTE7	8 bit	signed or unsigned char
FB1.USERWORD0 to FB1.USERWORD3	16 bit	signed or unsigned short
FB1.USERDWORD0 to FB1.USERDWORD1	32 bit	singed or unsigned int

The parameters overlap each other in the following way:

BYTE0	BYTE1	BYTE2	BYTE3	BYTE4	BYTE5	BYTE6	BYT7
WORD0		WORD1		WORD2		WORD3	
DWORD0				DWORD1			

For example, if BYTE1 is modified, WORD0 and DWORD0 are modified as well.

Example

```
-->FB1.USERDWORD1 65536
-->FB1.USERBYTE1
0
-->FB1.USERBYTE2
1
-->FB1.USERBYTE3
0

-->FB1.USERBYTE3 1 (write to the highest byte of FB1.USERDWORD0)
-->FB1.USERDWORD0
16842752
-->FB1.USERWORD0
0
-->FB1.USERWORD1
257
```

7.17.30 FB1.USERWORD0 to FB1.USERWORD3

General Information	
Type	R/W
Description	Reads and writes data stored in two 32 bit words in the Endat feedback device.
Units	N/A
Range	0 to 65,535
Default Value	0
Data Type	Integer
Start Version	M_01-05-08-000

Variants Supported

Variant	Supported
AKD Base	Yes
AKD with Position Indexer	Yes
AKD EtherCAT	Yes
AKD CANopen	Yes
AKD BASIC	Yes
AKD SynqNet	Yes
AKD EtherNet/IP	Yes
AKD Profinet	Yes
AKD sercos [®] III	Yes
AKD-N	Yes
AKD-C	No

Fieldbus Information

Fieldbus	Address	Attributes	Signed?
Profinet	2815	Word	No
sercos [®] III		2 Octets	

Description

FB1.USERBYTE, FB1.USERWORD, and FB1.USERDWORD share two 32bit words in the Endat feedback device. These three parameters offer different ways to store and access the data stored in these two 32bit words. The table below defines each parameters function. The values are automatically stored non-volatile in the feedback device.

Parameter	Bits	Attributes
FB1.USERBYTE0 to FB1.USERBYTE7	8 bit	signed or unsigned char
FB1.USERWORD0 to FB1.USERWORD3	16 bit	signed or unsigned short
FB1.USERDWORD0 to FB1.USERDWORD1	32 bit	singed or unsigned int

The parameters overlap each other in the following way:

BYTE0	BYTE1	BYTE2	BYTE3	BYTE4	BYTE5	BYTE6	BYT7
WORD0		WORD1		WORD2		WORD3	
DWORD0				DWORD1			

For example, if BYTE1 is modified, WORD0 and DWORD0 are modified as well.

Example

```
-->FB1.USERDWORD1 65536
-->FB1.USERBYTE1
0
-->FB1.USERBYTE2
1
-->FB1.USERBYTE3
0

-->FB1.USERBYTE3 1 (write to the highest byte of FB1.USERDWORD0)
-->FB1.USERDWORD0
16842752
-->FB1.USERWORD0
0
-->FB1.USERWORD1
257
```

7.18 FB2 Parameters

This section describes the FB2 parameters.

7.18.1 FB2.ENCRES	451
7.18.2 FB2.MODE	452
7.18.3 FB2.MOTORPHASE	453
7.18.4 FB2.MOTORPOLES	454
7.18.5 FB2.P	455
7.18.6 FB2.DIR	456
7.18.7 FB2.POFFSET	457
7.18.8 FB2.PUNIT	458
7.18.9 FB2.SOURCE	459

7.18.1 FB2.ENCRES

General Information	
Type	NV Parameter
Description	Sets the secondary feedback (FB2) resolution (also defines resolution of virtual encoder in AKD BASIC).
Units	counts/rev
Range	0 to 262,140 counts/rev
Default Value	0
Data Type	Integer
See Also	FB2.MODE, FB2.SOURCE (pg 459)
Start Version	M_01-03-00-000

Variants Supported

Variant	Supported
AKD Base	Yes
AKD with Position Indexer	Yes
AKD EtherCAT	Yes
AKD CANopen	Yes
AKD BASIC	Yes
AKD SynqNet	Yes
AKD EtherNet/IP	Yes
AKD Profinet	Yes
AKD sercos [®] III	Yes
AKD-N	No
AKD-C	No

Fieldbus Information

Fieldbus	Address	Attributes	Signed?
Profinet	2492	DWord	No
sercos [®] III		4 Octets	

Fieldbus	Index/Subindex	Is 64 bit?	Attributes	Signed?
Modbus	984	No	32 bit	No

Description

This parameter sets the feedback 2 (FB2) resolution and defines how many counts input into the secondary feedback will be considered a full revolution.

In AKD BASIC FB2.ENCRES also defines the resolution of the virtual encoder when using the CAMVM commands. A runtime error will occur if you use the CAMVM commands without defining a resolution in FB2.ENCRES. If a real encoder and a virtual encoder are both used, the resolution for the virtual encoder will be that of the real encoder.

7.18.2 FB2.MODE

General Information	
Type	R/W Parameter
Description	Sets the mode for the second feedback inputs, EEO connector (X9) and high speed opto inputs (pins 9 and 10 on X7).
Units	N/A
Range	0 to 2
Default Value	0
Data Type	Integer
See Also	FB2.ENCRES (pg 451), PL.FBSOURCE (pg 623)
Start Version	M_01-03-00-000

Variants Supported

Variant	Supported
AKD Base	Yes
AKD with Position Indexer	Yes
AKD EtherCAT	Yes
AKD CANopen	Yes
AKD BASIC	Yes
AKD SynqNet	Yes
AKD EtherNet/IP	Yes
AKD Profinet	Yes
AKD sercos [®] III	Yes
AKD-N	No
AKD-C	No

Fieldbus Information

Fieldbus	Address	Attributes	Signed?
Profinet	2493	Word	No
sercos [®] III		2 Octets	

Fieldbus	Index/Subindex	Is 64 bit?	Attributes	Signed?
Modbus	986	No	16 bit	No

Description

This parameter sets the feedback 2 input type as follows:

0 = Input A/B Signals

1 = Input Step and Direction Signals

2 = Input, up-down signals

7.18.3 FB2.MOTORPHASE

General Information	
Type	NV Parameter
Description	Sets the motor phase of the motor associated with FB2.
Units	Electrical degrees
Range	0 to 359
Default Value	0
Data Type	Integer
Start Version	M_01-11-04-000

Variants Supported

Variant	Supported
AKD Base	Yes
AKD with Position Indexer	Yes
AKD EtherCAT	Yes
AKD CANopen	Yes
AKD BASIC	Yes
AKD SynqNet	Yes
AKD EtherNet/IP	Yes
AKD Profinet	Yes
AKD sercos [®] III	Yes
AKD-N	No
AKD-C	No

Description

This parameter sets the phase offset for commutation of the motor associated with FB2. When multiple motors are driven by a single AKD, this allows different motor configurations to be saved for each value of IL.FBSOURCE.

When IL.FBSOURCE is set to 1, the value of FB2.MOTORPHASE will overwrite the value of MOTOR.PHASE (pg 567). Additionally, while IL.FBSOURCE = 1, a write to MOTOR.PHASE will also overwrite FB2.MOTORPHASE.

7.18.4 FB2.MOTORPOLES

General Information	
Type	NV Parameter
Description	Sets the number of motor poles associated with FB2.
Units	N/A
Range	0 to 510
Default Value	0
Data Type	Integer
Start Version	M_01-11-04-000

Variants Supported

Variant	Supported
AKD Base	Yes
AKD with Position Indexer	Yes
AKD EtherCAT	Yes
AKD CANopen	Yes
AKD BASIC	Yes
AKD SynqNet	Yes
AKD EtherNet/IP	Yes
AKD Profinet	Yes
AKD sercos [®] III	Yes
AKD-N	No
AKD-C	No

Description

This parameter sets the number of motor poles associated with FB2. When multiple motors are driven by a single AKD, this allows different motor configurations to be saved for each value of IL.FBSOURCE (→ p. 1).

When IL.FBSOURCE is set to 1, the value of FB2.MOTORPOLES will overwrite the current value of MOTOR.POLES (pg 571). Additionally, while IL.FBSOURCE = 1, a write to MOTOR.POLES will also overwrite FB2.MOTORPOLES.

7.18.5 FB2.P

General Information	
Type	R/O Parameter
Description	Reads position from the secondary feedback.
Units	Depends on FB1.PUNIT (pg 438) counts or custom units.
Range	N/A
Default Value	N/A
Data Type	U64
See Also	FB1.HALLSTATE (pg 413)
Start Version	M_01-05-08-000

Variants Supported

Variant	Supported
AKD Base	Yes
AKD with Position Indexer	Yes
AKD EtherCAT	Yes
AKD CANopen	Yes
AKD BASIC	Yes
AKD SynqNet	Yes
AKD EtherNet/IP	Yes
AKD Profinet	Yes
AKD sercos [®] III	Yes
AKD-N	No
AKD-C	No

Fieldbus Information

Fieldbus	Address	Attributes	Signed?
Profinet	2816	DWord	Yes
sercos [®] III		8 Octets	

Fieldbus	Index/Subindex	Is 64 bit?	Attributes	Signed?	Object Start Version
Modbus	1632	Yes	64-bits	Yes	M_01-06-03-000

Description

This parameter reads the position back from the secondary feedback device that is connected to X7 or X9, depending on the value of DRV.EMUEMODE. The position can be read as 32-bit counts or in customer units.

7.18.6 FB2.DIR

General Information	
Type	NV-Parameter
Description	Sets the counting direction for feedback channel 2.
Units	None
Range	0 to 1
Default Value	0
Data Type	U8
See Also	N/A
Start Version	M_01-05-11-000

Variants Supported

Variant	Supported
AKD Base	Yes
AKD with Position Indexer	Yes
AKD EtherCAT	Yes
AKD CANopen	Yes
AKD BASIC	Yes
AKD SynqNet	Yes
AKD EtherNet/IP	Yes
AKD Profinet	Yes
AKD sercos [®] III	Yes
AKD-N	No
AKD-C	No

Fieldbus Information

Fieldbus	Address	Attributes	Signed?
Profinet	2610	Byte	No
sercos [®] III		2 Octets	

Description

FB2.DIR will change the sign and with it the direction of feedback channel 2.

7.18.7 FB2.POFFSET

General Information	
Type	NV-Parameter
Description	Sets the offset for secondary feedback.
Units	counts, custom units
Range	-5,123,372,000,000,005.000 to 5,123,372,000,000,005.000 counts or -10,485,760.000 to 10,485,760.000 custom units
Default Value	0
Data Type	S64
See Also	N/A
Start Version	M_01-05-11-000

Variants Supported

Variant	Supported
AKD Base	Yes
AKD with Position Indexer	Yes
AKD EtherCAT	Yes
AKD CANopen	Yes
AKD BASIC	Yes
AKD SynqNet	Yes
AKD EtherNet/IP	Yes
AKD Profinet	Yes
AKD sercos [®] III	Yes
AKD-N	No
AKD-C	No

Fieldbus Information

Fieldbus	Address	Attributes	Signed?
Profinet	2819	DWord	Yes
sercos [®] III		8 Octets	

Fieldbus	Index/Subindex	Is 64 bit?	Attributes	Signed?	Object Start Version
Modbus	1638	Yes	64-bits	Yes	M_01-06-03-000

Description

FB2.POFFSET is the value added to the primary feedback position (FB2.P (pg 455)).

Example

If FB2.P is 10000 counts and FB2.POFFSET is set to -10000 counts, then the next read of FB2.P will return ~0 counts.

7.18.8 FB2.PUNIT

General Information	
Type	NV Parameter
Description	Sets the unit for FB2.P.
Units	N/A
Range	0, 3
Default Value	0
Data Type	U8
See Also	N/A
Start Version	M_01-05-11-000

Variants Supported

Variant	Supported
AKD Base	Yes
AKD with Position Indexer	Yes
AKD EtherCAT	Yes
AKD CANopen	Yes
AKD BASIC	Yes
AKD SynqNet	Yes
AKD EtherNet/IP	Yes
AKD Profinet	Yes
AKD sercos [®] III	Yes
AKD-N	No
AKD-C	No

Fieldbus Information

Fieldbus	Address	Attributes	Signed?
Profinet	2822	DWord	No
sercos [®] III		4 Octets	

Fieldbus	Index/Subindex	Is 64 bit?	Attributes	Signed?	Object Start Version
Modbus	1644	No	32-bits	No	M_01-06-03-000

Description

FB2.PUNIT sets the position unit for FB2.P.

Value	Description
0	Counts (32 bit format)
3	(FB2.PIN/FB2.POUT) per revolution.

Related Topics

FB2.P (pg 455)

7.18.9 FB2.SOURCE

General Information	
Type	R/W Parameter
Description	Sets the source for the second feedback input. Choices are the EEO connectors (X9) which are RS485 inputs, or the X7 connector's high speed opto inputs (pins 9 and 10).
Units	N/A
Range	0 to 2
Default Value	0
Data Type	Integer
See Also	FB2.ENCRES, FB2.MODE, PL.FBSOURCE (pg 623)
Start Version	M_01-03-00-000

Variants Supported

Variant	Supported
AKD Base	Yes
AKD with Position Indexer	Yes
AKD EtherCAT	Yes
AKD CANopen	Yes
AKD BASIC	Yes
AKD SynqNet	Yes
AKD EtherNet/IP	Yes
AKD Profinet	Yes
AKD sercos [®] III	Yes
AKD-N	No
AKD-C	No

Fieldbus Information

Fieldbus	Address	Attributes	Signed?
Profinet	2494	Word	No
sercos [®] III		2 Octets	

Fieldbus	Index/Subindex	Is 64 bit?	Attributes	Signed?
Modbus	988	No	16 bit	No

Description

This parameter sets the secondary feedback source to be either the EEO connector (X9) or the high speed opto inputs on the I/O Connector (X7) as follows:

0 = None

1 = Feedback Source X9 (EEO connector)

2 = Feedback Source X7 (High Speed Opto Inputs on the I/O Connector)

FB2 5V Power Supply Notes:

If FB2.SOURCE = 0 or 2 (X7), the 5V power supply will remain off.

If FB2.SOURCE = 1 (X9) the FB2 5V power supply will remain on unless a short is detected. This is useful for encoder types that may require calibration.

7.19 FB3 Parameters

This section describes the FB3 parameters.

7.19.1 FB3.DIR	461
7.19.2 FB3.MODE	462
7.19.3 FB3.MOTORPHASE	463
7.19.4 FB3.MOTORPOLES	464
7.19.5 FB3.P	465
7.19.6 FB3.PDIR	466
7.19.7 FB3.POFFSET	467
7.19.8 FB3.PUNIT	468

7.19.1 FB3.DIR

General Information	
Type	NV Parameter
Description	Sets the counting direction for the position feedback when PL.FBSOURCE = 2.
Units	None
Range	0 to 1
Default Value	0
Data Type	U8
See Also	N/A
Start Version	M_01-11-03-000

Variants Supported

Variant	Supported
AKD Base	No
AKD with Position Indexer	No
AKD EtherCAT	Yes
AKD CANopen	Yes
AKD BASIC	Yes
AKD SynqNet	Yes
AKD EtherNet/IP	Yes
AKD Profinet	Yes
AKD sercos [®] III	Yes
AKD-N	No
AKD-C	No

Description

FB3.DIR will change the sign and with it the direction of the position feedback (PL.FB (pg 621)) when PL.FBSOURCE = 2 (FB3).

7.19.2 FB3.MODE

General Information	
Type	NV Parameter
Description	Selects the type of feedback connected to X9.
Units	N/A
Range	0
Default Value	0
Data Type	Integer
See Also	NA
Start Version	M_01-04-15-000

Variants Supported

Variant	Supported
AKD Base	No
AKD with Position Indexer	No
AKD EtherCAT	Yes
AKD CANopen	Yes
AKD BASIC	Yes
AKD SynqNet	Yes
AKD EtherNet/IP	Yes
AKD Profinet	Yes
AKD sercos [®] III	Yes
AKD-N	No
AKD-C	No

Fieldbus Information

Fieldbus	Address	Attributes	Signed?
Profinet	2522	Word	No
sercos [®] III		2 Octets	

Fieldbus	Index/Subindex
Modbus	1044

Description

This parameter selects the type of feedback connected to X9. The position is reported as the tertiary feedback position, by FB3.P.

Value	Feedback
0	Endat 2.2 Feedback Device

This parameter is only supported on drives with model numbers similar to AKD-x-xxxxx-NBxx-xxxx.

7.19.3 FB3.MOTORPHASE

General Information	
Type	NV Parameter
Description	Sets the motor phase of the motor associated with FB3.
Units	Electrical degrees
Range	0 to 359
Default Value	0
Data Type	Integer
Start Version	M_01-11-04-000

Variants Supported

Variant	Supported
AKD Base	Yes
AKD with Position Indexer	Yes
AKD EtherCAT	Yes
AKD CANopen	Yes
AKD BASIC	Yes
AKD SynqNet	Yes
AKD EtherNet/IP	Yes
AKD Profinet	Yes
AKD sercos [®] III	Yes
AKD-N	No
AKD-C	No

Description

This parameter sets the phase offset for commutation of the motor associated with FB3. When multiple motors are driven by a single AKD, this allows different motor configurations to be saved for each value of IL.FBSOURCE.

When IL.FBSOURCE is set to 2, the value of FB3.MOTORPHASE will overwrite the value of MOTOR.PHASE (pg 567). Additionally, while IL.FBSOURCE = 2, a write to MOTOR.PHASE will also overwrite FB3.MOTORPHASE.

7.19.4 FB3.MOTORPOLES

General Information	
Type	NV Parameter
Description	Sets the number of motor poles associated with FB3.
Units	N/A
Range	0 to 510
Default Value	0
Data Type	Integer
Start Version	M_01-11-04-000

Variants Supported

Variant	Supported
AKD Base	Yes
AKD with Position Indexer	Yes
AKD EtherCAT	Yes
AKD CANopen	Yes
AKD BASIC	Yes
AKD SynqNet	Yes
AKD EtherNet/IP	Yes
AKD Profinet	Yes
AKD sercos [®] III	Yes
AKD-N	No
AKD-C	No

Description

This parameter sets the number of motor poles associated with FB3. When multiple motors are driven by a single AKD, this allows different motor configurations to be saved for each value of IL.FBSOURCE (→ p. 1).

When IL.FBSOURCE is set to 2, the value of FB3.MOTORPOLES will overwrite the current value of MOTOR.POLES (pg 571). Additionally, while IL.FBSOURCE = 2, a write to MOTOR.POLES will also overwrite FB3.MOTORPOLES.

7.19.5 FB3.P

General Information	
Type	R/O Parameter
Description	Reads position from the tertiary feedback.
Units	Depends on FB3.PUNIT (pg 468) counts or custom units.
Range	N/A
Default Value	N/A
Data Type	S64
See Also	N/A
Start Version	M_01-04-15-000

Variants Supported

Variant	Supported
AKD Base	No
AKD with Position Indexer	No
AKD EtherCAT	Yes
AKD CANopen	Yes
AKD BASIC	Yes
AKD SynqNet	Yes
AKD EtherNet/IP	Yes
AKD Profinet	Yes
AKD sercos [®] III	Yes
AKD-N	No
AKD-C	No

Fieldbus Information

Fieldbus	Parameter	Address	Attributes	Signed?
Profinet	FB3.P_32	2523	DWord	Yes
sercos [®] III			8 Octets	
Profinet	FB3.P	2823	DWord	
sercos [®] III			8 Octets	

Fieldbus	Index/Subindex	Is 64 bit?	Attributes	Signed?	Object Start Version
Modbus	1646	Yes	64-bits	Yes	M_01-06-03-000

Description

This parameter reads the position back from the tertiary feedback device that is connected to X9, when DRV.EMUEMODE = 11. The position can be read as 64-bit signed count or in customer units. Values read by this parameter depend on FB3.Dir and FB3.OFFSET.

This parameter is only supported on drives with model numbers similar to AKD-x-xyzz-NBxx-yyzz and will only work with Endat 2.2 multiturn encoder. The output format is 32:32 the upper 32 bits represents the multiturns and the lower 32 bits for position of the feedback.

Related Topics

DRV.EMUEMODE (pg 328) | FB3.PUNIT (pg 468) | FB3.PIN | FB3.POUT | FB3.PDIR (pg 466) |

7.19.6 FB3.PDIR

General Information	
Type	NV-Parameter
Description	Sets the counting direction for feedback channel 3.
Units	None
Range	0 to 1
Default Value	0
Data Type	U8
See Also	N/A
Start Version	M_01-05-11-000

Variants Supported

Variant	Supported
AKD Base	No
AKD with Position Indexer	No
AKD EtherCAT	Yes
AKD CANopen	Yes
AKD BASIC	Yes
AKD SynqNet	Yes
AKD EtherNet/IP	Yes
AKD Profinet	Yes
AKD sercos [®] III	Yes
AKD-N	No
AKD-C	No

Fieldbus Information

Fieldbus	Address	Attributes	Signed?
Profinet	2825	Byte	No
sercos [®] III		2 Octets	

Fieldbus	Index/Subindex	Is 64 bit?	Attributes	Signed?	Object Start Version
Modbus	1650	No	8-bits	No	M_01-06-03-000

Description

FB3.PDIR will change the sign and with it the direction of feedback channel 3 (FB3.P (pg 465)).

Example

If FB3.P = 35,185.932 and you set:

→ FB3.PDIR 1

then FB3.P = -35,185.932

7.19.7 FB3.POFFSET

General Information	
Type	NV-Parameter
Description	Sets the offset for tertiary feedback.
Units	counts, custom units
Range	-5,123,372,000,000,005.000 to 5,123,372,000,000,005.000 counts or -10,485,760.000 to 10,485,760.000 custom units
Default Value	0
Data Type	S64
See Also	N/A
Start Version	M_01-05-11-000

Variants Supported

Variant	Supported
AKD Base	No
AKD with Position Indexer	No
AKD EtherCAT	Yes
AKD CANopen	Yes
AKD BASIC	Yes
AKD SynqNet	Yes
AKD EtherNet/IP	Yes
AKD Profinet	Yes
AKD sercos [®] III	Yes
AKD-N	No
AKD-C	No

Fieldbus Information

Fieldbus	Address	Attributes	Signed?
Profinet	2827	DWord	Yes
sercos [®] III		8 Octets	

Fieldbus	Index/Subindex	Is 64 bit?	Attributes	Signed?	Object Start Version
Modbus	1654	Yes	64-bits	Yes	M_01-06-03-000

Description

FB3.POFFSET is the value added to the primary feedback position (FB3.P (pg 465)).

Example

If FB3.P is 10000 counts and FB3.POFFSET is set to -10000 counts, then the next read of FB3.P will return ~0 counts.

7.19.8 FB3.PUNIT

General Information	
Type	NV Parameter
Description	Sets the unit for FB3.P.
Units	N/A
Range	0, 3
Default Value	0
Data Type	U8
See Also	N/A
Start Version	M_01-05-11-000

Variants Supported

Variant	Supported
AKD Base	No
AKD with Position Indexer	No
AKD EtherCAT	Yes
AKD CANopen	Yes
AKD BASIC	Yes
AKD SynqNet	Yes
AKD EtherNet/IP	Yes
AKD Profinet	Yes
AKD sercos [®] III	Yes
AKD-N	No
AKD-C	No

Fieldbus Information

Fieldbus	Address	Attributes	Signed?
Profinet	2830	DWord	No
sercos [®] III		4 Octets	

Fieldbus	Index/Subindex	Is 64 bit?	Attributes	Signed?	Object Start Version
Modbus	1660	No	32-bits	No	M_01-06-03-000

Description

FB3.UNIT sets the position unit for FB3.P.

Value	Description
0	Counts (32.32 format)
3	(FB3.PIN/FB3.POUT) per revolution.

Related Topics

FB3.P (pg 465)

7.20 GUI Parameters

GUI parameters are used within WorkBench for data reporting and data storage.

7.20.1 GUI.DISPLAY	470
7.20.2 GUI.PARAM01	471
7.20.3 GUI.PARAM02	472
7.20.4 GUI.PARAM03	473
7.20.5 GUI.PARAM04	474
7.20.6 GUI.PARAM05	475
7.20.7 GUI.PARAM06	476
7.20.8 GUI.PARAM07	477
7.20.9 GUI.PARAM08	478
7.20.10 GUI.PARAM09	479
7.20.11 GUI.PARAM10	480

7.20.1 GUI.DISPLAY

General Information	
Type	R/O Parameter
Description	Reads drive display data.
Units	N/A
Range	N/A
Default Value	N/A
Data Type	Display
See Also	N/A
Start Version	M_01-00-00-000

Variants Supported

Variant	Supported
AKD Base	Yes
AKD with Position Indexer	Yes
AKD EtherCAT	Yes
AKD CANopen	Yes
AKD BASIC	Yes
AKD SynqNet	Yes
AKD EtherNet/IP	Yes
AKD Profinet	Yes
AKD sercos [®] III	Yes
AKD-N	Yes
AKD-C	Yes

Description

This parameter reports to the GUI what the drive currently is displaying. For all GUI commands, the data is compressed and formatted for the GUI, not for the user.

7.20.2 GUI.PARAM01

General Information	
Type	NV Parameter
Description	Used by the GUI to store data.
Units	N/A
Range	2,147,483,648 to 2,147,483,647
Default Value	0
Data Type	Integer
See Also	N/A
Start Version	M_01-00-00-000

Variants Supported

Variant	Supported
AKD Base	Yes
AKD with Position Indexer	Yes
AKD EtherCAT	Yes
AKD CANopen	Yes
AKD BASIC	Yes
AKD SynqNet	Yes
AKD EtherNet/IP	Yes
AKD Profinet	Yes
AKD sercos [®] III	Yes
AKD-N	Yes
AKD-C	Yes

Description

The GUI uses this parameter to store data. Only the GUI can modify this data (not the user).

7.20.3 GUI.PARAM02

General Information	
Type	NV Parameter
Description	Used by the GUI to store data.
Units	N/A
Range	2,147,483,648 to 2,147,483,647
Default Value	0
Data Type	Integer
See Also	N/A
Start Version	M_01-00-00-000

Variants Supported

Variant	Supported
AKD Base	Yes
AKD with Position Indexer	Yes
AKD EtherCAT	Yes
AKD CANopen	Yes
AKD BASIC	Yes
AKD SynqNet	Yes
AKD EtherNet/IP	Yes
AKD Profinet	Yes
AKD sercos [®] III	Yes
AKD-N	Yes
AKD-C	Yes

Description

The GUI uses this parameter to store data. Only the GUI can modify this data (not the user).

7.20.4 GUI.PARAM03

General Information	
Type	NV Parameter
Description	Used by the GUI to store data.
Units	N/A
Range	2,147,483,648 to 2,147,483,647
Default Value	0
Data Type	Integer
See Also	N/A
Start Version	M_01-00-00-000

Variants Supported

Variant	Supported
AKD Base	Yes
AKD with Position Indexer	Yes
AKD EtherCAT	Yes
AKD CANopen	Yes
AKD BASIC	Yes
AKD SynqNet	Yes
AKD EtherNet/IP	Yes
AKD Profinet	Yes
AKD sercos [®] III	Yes
AKD-N	Yes
AKD-C	Yes

Description

The GUI uses this parameter to store data. Only the GUI can modify this data (not the user).

7.20.5 GUI.PARAM04

General Information	
Type	NV Parameter
Description	Used by the GUI to store data.
Units	N/A
Range	2,147,483,648 to 2,147,483,647
Default Value	0
Data Type	Integer
See Also	N/A
Start Version	M_01-00-00-000

Variants Supported

Variant	Supported
AKD Base	Yes
AKD with Position Indexer	Yes
AKD EtherCAT	Yes
AKD CANopen	Yes
AKD BASIC	Yes
AKD SynqNet	Yes
AKD EtherNet/IP	Yes
AKD Profinet	Yes
AKD sercos [®] III	Yes
AKD-N	Yes
AKD-C	Yes

Description

The GUI uses this parameter to store data. Only the GUI can modify this data (not the user).

7.20.6 GUI.PARAM05

General Information	
Type	NV Parameter
Description	Used by the GUI to store data.
Units	N/A
Range	2,147,483,648 to 2,147,483,647
Default Value	0
Data Type	Integer
See Also	N/A
Start Version	M_01-00-00-000

Variants Supported

Variant	Supported
AKD Base	Yes
AKD with Position Indexer	Yes
AKD EtherCAT	Yes
AKD CANopen	Yes
AKD BASIC	Yes
AKD SynqNet	Yes
AKD EtherNet/IP	Yes
AKD Profinet	Yes
AKD sercos [®] III	Yes
AKD-N	Yes
AKD-C	Yes

Description

The GUI uses this parameter to store data. Only the GUI can modify this data (not the user).

7.20.7 GUI.PARAM06

General Information	
Type	NV Parameter
Description	Used by the GUI to store data.
Units	N/A
Range	2,147,483,648 to 2,147,483,647
Default Value	0
Data Type	Integer
See Also	N/A
Start Version	M_01-00-00-000

Variants Supported

Variant	Supported
AKD Base	Yes
AKD with Position Indexer	Yes
AKD EtherCAT	Yes
AKD CANopen	Yes
AKD BASIC	Yes
AKD SynqNet	Yes
AKD EtherNet/IP	Yes
AKD Profinet	Yes
AKD sercos [®] III	Yes
AKD-N	Yes
AKD-C	Yes

Description

The GUI uses this parameter to store data. Only the GUI can modify this data (not the user).

7.20.8 GUI.PARAM07

General Information	
Type	NV Parameter
Description	Used by the GUI to store data.
Units	N/A
Range	2,147,483,648 to 2,147,483,647
Default Value	0
Data Type	Integer
See Also	N/A
Start Version	M_01-00-00-000

Variants Supported

Variant	Supported
AKD Base	Yes
AKD with Position Indexer	Yes
AKD EtherCAT	Yes
AKD CANopen	Yes
AKD BASIC	Yes
AKD SynqNet	Yes
AKD EtherNet/IP	Yes
AKD Profinet	Yes
AKD sercos [®] III	Yes
AKD-N	Yes
AKD-C	Yes

Description

The GUI uses this parameter to store data. Only the GUI can modify this data (not the user).

7.20.9 GUI.PARAM08

General Information	
Type	NV Parameter
Description	Used by the GUI to store data.
Units	N/A
Range	2,147,483,648 to 2,147,483,647
Default Value	0
Data Type	Integer
See Also	N/A
Start Version	M_01-00-00-000

Variants Supported

Variant	Supported
AKD Base	Yes
AKD with Position Indexer	Yes
AKD EtherCAT	Yes
AKD CANopen	Yes
AKD BASIC	Yes
AKD SynqNet	Yes
AKD EtherNet/IP	Yes
AKD Profinet	Yes
AKD sercos [®] III	Yes
AKD-N	Yes
AKD-C	Yes

Description

The GUI uses this parameter to store data. Only the GUI can modify this data (not the user).

7.20.10 GUI.PARAM09

General Information	
Type	NV Parameter
Description	Used by the GUI to store data.
Units	N/A
Range	2,147,483,648 to 2,147,483,647
Default Value	0
Data Type	Integer
See Also	N/A
Start Version	M_01-00-00-000

Variants Supported

Variant	Supported
AKD Base	Yes
AKD with Position Indexer	Yes
AKD EtherCAT	Yes
AKD CANopen	Yes
AKD BASIC	Yes
AKD SynqNet	Yes
AKD EtherNet/IP	Yes
AKD Profinet	Yes
AKD sercos [®] III	Yes
AKD-N	Yes
AKD-C	Yes

Description

The GUI uses this parameter to store data. Only the GUI can modify this data (not the user).

7.20.11 GUI.PARAM10

General Information	
Type	NV Parameter
Description	Used by the GUI to store data.
Units	N/A
Range	2,147,483,648 to 2,147,483,647
Default Value	0
Data Type	Integer
See Also	N/A
Start Version	M_01-00-00-000

Variants Supported

Variant	Supported
AKD Base	Yes
AKD with Position Indexer	Yes
AKD EtherCAT	Yes
AKD CANopen	Yes
AKD BASIC	Yes
AKD SynqNet	Yes
AKD EtherNet/IP	Yes
AKD Profinet	Yes
AKD sercos [®] III	Yes
AKD-N	Yes
AKD-C	Yes

Description

The GUI uses this parameter to store data. Only the GUI can modify this data (not the user).

7.21 HWLS Parameters

This section describes the HWLS parameters.

7.21.1 HWLS.NEGSTATE	482
7.21.2 HWLS.POSSTATE	483

7.21.1 HWLS.NEGSTATE

General Information	
Type	R/O Parameter
Description	Reads the status of the negative hardware limit switch.
Units	0 to 1
Range	N/A
Default Value	Integer
Data Type	HWLS.POSSTATE (pg 483)
See Also	N/A
Start Version	M_01-00-00-000

Variants Supported

Variant	Supported
AKD Base	Yes
AKD with Position Indexer	Yes
AKD EtherCAT	Yes
AKD CANopen	Yes
AKD BASIC	Yes
AKD SynqNet	Yes
AKD EtherNet/IP	Yes
AKD Profinet	Yes
AKD sercos [®] III	Yes
AKD-N	Yes
AKD-C	No

Fieldbus Information

Fieldbus	Address	Attributes	Signed?
Profinet	2211	Byte	No
sercos [®] III		2 Octets	

Fieldbus	Index/Subindex	Is 64 bit?	Attributes	Signed?	Object Start Version
Modbus	422	No	8 bit	No	M_01-03-00-000

Description

HWLS.NEGSTATE reads the status of the negative HW limit switch as follows:

0 = Low

1 = High

7.21.2 HWLS.POSSTATE

General Information	
Type	R/O Parameter
Description	Reads the status of the positive hardware limit switch.
Units	N/A
Range	0 to 1
Default Value	N/A
Data Type	Integer
See Also	HWLS.NEGSTATE (pg 482)
Start Version	M_01-00-00-000

Variants Supported

Variant	Supported
AKD Base	Yes
AKD with Position Indexer	Yes
AKD EtherCAT	Yes
AKD CANopen	Yes
AKD BASIC	Yes
AKD SynqNet	Yes
AKD EtherNet/IP	Yes
AKD Profinet	Yes
AKD sercos [®] III	Yes
AKD-N	Yes
AKD-C	No

Fieldbus Information

Fieldbus	Address	Attributes	Signed?
Profinet	2212	Byte	No
sercos [®] III		2 Octets	

Fieldbus	Index/Subindex	Is 64 bit?	Attributes	Signed?	Object Start Version
Modbus	424	No	8 bit	No	M_01-03-00-000

Description

HWLS.POSSTATE reads the status of the positive hardware limit switch as follows:

0 = Low

1 = High

7.22 IL Parameters

This section describes the IL parameters.

7.22.1 IL.BUSFF	485
7.22.2 IL.CMD	486
7.22.3 IL.CMDU	487
7.22.4 IL.DFOLDT	488
7.22.5 IL.DIFOLD	489
7.22.6 IL.FB	490
7.22.7 IL.FF	491
7.22.8 IL.FOLDFTHRESH	492
7.22.9 IL.FOLDFTHRESHU	493
7.22.10 IL.FOLDWTHRESH	494
7.22.11 IL.FRCTION	495
7.22.12 IL.IFOLD	496
7.22.13 IL.IUFB	497
7.22.14 IL.IVFB	498
7.22.15 IL.KACFF	499
7.22.16 IL.KBUSFF	500
7.22.17 IL.KP	501
7.22.18 IL.KPDRATIO	502
7.22.19 IL.KPLOOKUPINDEX	503
7.22.20 IL.KPLOOKUPVALUE	504
7.22.21 IL.KPLOOKUPVALUES	506
7.22.22 IL.KVFF	507
7.22.23 IL.LIMITN	508
7.22.24 IL.LIMITP	509
7.22.25 IL.MFOLDD	510
7.22.26 IL.MFOLDR	511
7.22.27 IL.MFOLDT	512
7.22.28 IL.MI2T	513
7.22.29 IL.MI2TWTHRESH	514
7.22.30 IL.MIFOLD	515
7.22.31 IL.MIMODE	516
7.22.32 IL.OFFSET	517
7.22.33 IL.VCMD	518
7.22.34 IL.VUFB	519
7.22.35 IL.VVFB	520

7.22.1 IL.BUSFF

General Information	
Type	R/O Parameter
Description	Displays the current feedforward value injected by the fieldbus.
Units	Arms
Range	N/A
Default Value	N/A
Data Type	Float
Start Version	M_01-00-00-000

Variants Supported

Variant	Supported
AKD Base	Yes
AKD with Position Indexer	Yes
AKD EtherCAT	Yes
AKD CANopen	Yes
AKD BASIC	Yes
AKD SynqNet	Yes
AKD EtherNet/IP	Yes
AKD Profinet	Yes
AKD sercos [®] III	Yes
AKD-N	Yes
AKD-C	No

Fieldbus Information

Fieldbus	Address	Attributes	Signed?
Profinet	2213	DWord	Yes
sercos [®] III		4 Octets	

Fieldbus	Index/Subindex	Is 64 bit?	Attributes	Signed?	Object Start Version
Modbus	426	No	32 bit	Yes	M_01-03-00-000

Description

This parameter displays the current feedforward value injected by the fieldbus.

7.22.2 IL.CMD

General Information	
Type	R/O Parameter
Description	Reads the value of the q-component current command.
Units	Arms
Range	± Drive peak current (DRV.IPEAK)
Default Value	N/A
Data Type	Float
See Also	DRV.IPEAK (pg 355)
Start Version	M_01-00-00-000

Variants Supported

Variant	Supported
AKD Base	Yes
AKD with Position Indexer	Yes
AKD EtherCAT	Yes
AKD CANopen	Yes
AKD BASIC	Yes
AKD SynqNet	Yes
AKD EtherNet/IP	Yes
AKD Profinet	Yes
AKD sercos [®] III	Yes
AKD-N	Yes
AKD-C	No

Fieldbus Information

Fieldbus	Address	Attributes	Signed?
Profinet	2214	DWord	Yes
sercos [®] III		4 Octets	

Fieldbus	Index/Subindex	Is 64 bit?	Attributes	Signed?	Object Start Version
Modbus	428	No	32 bit	Yes	M_01-03-00-000

Description

IL.CMD displays the q-component current command value of the current loop after any limitation (such as a parameter setting or I^2t calculation).

IL.CMD is limited also by motor peak current, IL.LIMITN (pg 508) and IL.LIMITP (pg 509).

7.22.3 IL.CMDU

General Information	
Type	R/W Parameter
Description	Sets the user current command.
Units	Arms
Range	Minimum range value = maximum of IL.LIMITN and -MOTOR.IPEAK Maximum range value = minimum of IL.LIMITP and MOTOR.IPEAK
Default Value	0 Arms
Data Type	Float
See Also	DRV.IPEAK (pg 355), DRV.OPMODE (pg 370), DRV.CMDSOURCE (pg 312)
Start Version	M_01-00-00-000

Variants Supported

Variant	Supported
AKD Base	Yes
AKD with Position Indexer	Yes
AKD EtherCAT	Yes
AKD CANopen	Yes
AKD BASIC	Yes
AKD SynqNet	Yes
AKD EtherNet/IP	Yes
AKD Profinet	Yes
AKD sercos [®] III	Yes
AKD-N	Yes
AKD-C	No

Fieldbus Information

Fieldbus	Address	Attributes	Signed?
Profinet	2215	DWord	Yes
sercos [®] III		4 Octets	

Fieldbus	Index/Subindex	Is 64 bit?	Attributes	Signed?	Object Start Version
Modbus	430	No	32 bit	Yes	M_01-03-00-000

Description

This parameter sets the user current command value.

The current command value, which is provided to the current loop (IL.CMD), can be limited further using a parameter setting or I^2t calculation. IL.CMDU is limited also by motor peak current, IL.LIMITN (pg 508) and IL.LIMITP (pg 509).

For IPM motors (MOTOR.TYPE = 6), IL.CMDU is decomposed into d-component and q-component current values, as both are used for closed loop current control. The d-component value is used to set IL.DCMD (pg 1), and the q-component value is used to set IL.CMD (pg 486).

7.22.4 IL.DFOLDT

General Information	
Type	R/W Parameter
Description	Reads the drive foldback time constant of the exponential current drop (fold-back).
Units	s
Range	1 to 65.535 s
Default Value	Usually 2.500 s, but may change according to the drive type.
Data Type	Float
Start Version	M_01-00-00-000

Variants Supported

This parameter is only available on AKD BASIC drives.

Description

IL.DFOLDT is the time constant of the exponential drop (foldback) of the current towards the drive continuous current.

7.22.5 IL.DIFOLD

General Information	
Type	R/O Parameter
Description	Reads the drive foldback current limit.
Units	Arms
Range	0 to 2,147,483.647 Arms
Default Value	N/A
Data Type	Float
Start Version	M_01-00-00-000

Variants Supported

Variant	Supported
AKD Base	Yes
AKD with Position Indexer	Yes
AKD EtherCAT	Yes
AKD CANopen	Yes
AKD BASIC	Yes
AKD SynqNet	Yes
AKD EtherNet/IP	Yes
AKD Profinet	Yes
AKD sercos [®] III	Yes
AKD-N	Yes
AKD-C	No

Fieldbus Information

Fieldbus	Index/Subindex	Object Start Version
EtherCAT COE and CANopen CANopen	3559h/0	M_01-00-00-000

Fieldbus	Address	Attributes	Signed?
Profinet	2833	DWord	No
sercos [®] III		4 Octets	

Fieldbus	Index/Subindex	Is 64 bit?	Attributes	Signed?	Object Start Version
Modbus	1666	No	32-bits	No	M_01-06-03-000

Description

IL.DIFOLD is the output of the drive foldback algorithm. It is an artificial current, which can be higher or lower than the drive peak current (DRV.IPEAK). When IL.DIFOLD is lower than the existing current limit (such as IL.LIMITP (pg 509)), it becomes the active current limit.

IL.DIFOLD decreases when the actual current is higher than drive continuous current and increases (up to a certain level) when the actual current is lower than drive continuous current.

7.22.6 IL.FB

General Information	
Type	R/O Parameter
Description	Reads the actual value of the d-component current.
Units	Arms
Range	± Drive peak current (DRV.IPEAK)
Default Value	N/A
Data Type	Float
See Also	N/A
Start Version	M_01-00-00-000

Variants Supported

Variant	Supported
AKD Base	Yes
AKD with Position Indexer	Yes
AKD EtherCAT	Yes
AKD CANopen	Yes
AKD BASIC	Yes
AKD SynqNet	Yes
AKD EtherNet/IP	Yes
AKD Profinet	Yes
AKD sercos [®] III	Yes
AKD-N	Yes
AKD-C	No

Fieldbus Information

Fieldbus	Index/Subindex	Object Start Version
EtherCAT COE and CANopen CANopen	3558h/0	M_01-00-00-000

Fieldbus	Address	Attributes	Signed?
Profinet	2216	DWord	Yes
sercos [®] III		4 Octets	

Fieldbus	Index/Subindex	Is 64 bit?	Attributes	Signed?	Object Start Version
Modbus	432	No	32 bit	Yes	M_01-03-00-000

Description

This parameter reads the measured, de-rotated actual current value of the motor.

Note: Internally the resolution of the current scale is 20130 increments. For an AKD with a peak current of 9 amps, the current resolution applied is $9/20130 = .447$ mA. For a 48 amp peak current drive, the resolution is $48/20130 = 2.38$ mA. The current scaling is hard coded and cannot be changed by decreasing the peak current settings in the drive.

7.22.7 IL.FF

General Information	
Type	R/O Parameter
Description	Displays the current loop overall feedforward value
Units	Arms
Range	N/A
Default Value	N/A
Data Type	Float
See Also	IL.KBUSFF (pg 500), IL.KVFF (pg 507), IL.OFFSET (pg 517), IL.FRCTION (pg 495), IL.KACFF (pg 499)
Start Version	M_01-00-00-000

Variants Supported

Variant	Supported
AKD Base	Yes
AKD with Position Indexer	Yes
AKD EtherCAT	Yes
AKD CANopen	Yes
AKD BASIC	Yes
AKD SynqNet	Yes
AKD EtherNet/IP	Yes
AKD Profinet	Yes
AKD sercos [®] III	Yes
AKD-N	Yes
AKD-C	No

Fieldbus Information

Fieldbus	Address	Attributes	Signed?
Profinet	2217	DWord	No
sercos [®] III		4 Octets	

Fieldbus	Index/Subindex	Is 64 bit?	Attributes	Signed?	Object Start Version
Modbus	434	No	32 bit	No	M_01-03-00-000

Description

This parameter displays the current loop overall feedforward value.

7.22.8 IL.FOLDFTHRESH

General Information	
Type	R/O Parameter
Description	Reads the foldback fault level.
Units	Arms
Range	0 to 500 Arms
Default Value	Drive peak current (DRV.IPEAK)
Data Type	Float
Start Version	M_01-00-00-000

Variants Supported

Variant	Supported
AKD Base	Yes
AKD with Position Indexer	Yes
AKD EtherCAT	Yes
AKD CANopen	Yes
AKD BASIC	Yes
AKD SynqNet	Yes
AKD EtherNet/IP	Yes
AKD Profinet	Yes
AKD sercos [®] III	Yes
AKD-N	Yes
AKD-C	No

Fieldbus Information

Fieldbus	Index/Subindex	Object Start Version
EtherCAT COE and CANopen CANopen	3420h/0	M_01-00-00-000

Fieldbus	Address	Attributes	Signed?
Profinet	2218	DWord	No
sercos [®] III		4 Octets	

Fieldbus	Index/Subindex	Is 64 bit?	Attributes	Signed?	Object Start Version
Modbus	436	No	32 bit	No	M_01-03-00-000

Description

IL.FOLDFTHRESH is the fault level of the current foldback algorithm. If IL.IFOLD (pg 496) drops below the value for IL.FOLDFTHRESH, then a fault is generated and the drive is disabled.

To avoid reaching the current foldback fault level, set IL.FOLDFTHRESHU well below the continuous current value for both the drive and the motor or set the IL.FOLDFTHRESHU value to zero.

7.22.9 IL.FOLDFTHRESHU

General Information	
Type	NV Parameter
Description	Sets the user value for the foldback fault level.
Units	Arms
Range	0 to 500 Arms
Default Value	Drive peak current (DRV.IPEAK)
Data Type	Float
See Also	IL.FOLDFTHRESH (pg 492)
Start Version	M_01-00-00-000

Variants Supported

Variant	Supported
AKD Base	Yes
AKD with Position Indexer	Yes
AKD EtherCAT	Yes
AKD CANopen	Yes
AKD BASIC	Yes
AKD SynqNet	Yes
AKD EtherNet/IP	Yes
AKD Profinet	Yes
AKD sercos [®] III	Yes
AKD-N	Yes
AKD-C	No

Fieldbus Information

Fieldbus	Index/Subindex	Object Start Version
EtherCAT COE and CANopen CANopen	3421h/0	M_01-00-00-000

Fieldbus	Address	Attributes	Signed?
Profinet	2219	DWord	Yes
sercos [®] III		4 Octets	

Fieldbus	Index/Subindex	Is 64 bit?	Attributes	Signed?	Object Start Version
Modbus	438	No	32 bit	Yes	M_01-03-00-000

Description

IL.FOLDFTHRESHU is the fault level of the current foldback algorithm. The value of IL.FOLDFTHRESH is the minimum of DRV.IPEAK (pg 355), MOTOR.IPEAK (pg 560), and IL.FOLDFTHRESHU.

7.22.10 IL.FOLDWTHRESH

General Information	
Type	NV Parameter
Description	Sets the foldback warning level.
Units	Arms
Range	0 to 500 Arms
Default Value	0 A
Data Type	Float
Start Version	M_01-00-00-000

Variants Supported

Variant	Supported
AKD Base	Yes
AKD with Position Indexer	Yes
AKD EtherCAT	Yes
AKD CANopen	Yes
AKD BASIC	Yes
AKD SynqNet	Yes
AKD EtherNet/IP	Yes
AKD Profinet	Yes
AKD sercos [®] III	Yes
AKD-N	Yes
AKD-C	No

Fieldbus Information

Fieldbus	Index/Subindex	Object Start Version
EtherCAT COE and CANopen CANopen	355Ah/0	M_01-00-00-000

Fieldbus	Address	Attributes	Signed?
Profinet	2220	DWord	Yes
sercos [®] III		4 Octets	

Fieldbus	Index/Subindex	Is 64 bit?	Attributes	Signed?	Object Start Version
Modbus	440	No	32 bit	Yes	M_01-03-00-000

Description

IL.FOLDWTHRESH is the warning level of the current foldback algorithm. When IL.IFOLD (pg 496) drops **below** IL.FOLDWTHRESH a warning is generated.

To ensure that the current foldback warning level is never reached, IL.FOLDWTHRESH should be set well below the continuous current value for both the drive and the motor. You can also set the IL.FOLDFTHRESH (pg 492) value to zero.

7.22.11 IL.FRICTION

General Information	
Type	R/W Parameter
Description	Sets friction compensation value.
Units	A
Range	0 to the minimum of user positive current limit (IL.LIMITP) and motor peak current (MOTOR.IPEAK).IL.LIMITP (pg 509)
Default Value	0
Data Type	Float
See Also	IL.FF
Start Version	M_01-00-00-000

Variants Supported

Variant	Supported
AKD Base	Yes
AKD with Position Indexer	Yes
AKD EtherCAT	Yes
AKD CANopen	Yes
AKD BASIC	Yes
AKD SynqNet	Yes
AKD EtherNet/IP	Yes
AKD Profinet	Yes
AKD sercos® III	Yes
AKD-N	Yes
AKD-C	No

Fieldbus Information

Fieldbus	Index/Subindex	Object Start Version
EtherCAT COE and CANopen CANopen	3422h/0	M_01-00-00-000

Fieldbus	Address	Attributes	Signed?
Profinet	2221	DWord	No
sercos® III		4 Octets	

Fieldbus	Index/Subindex	Is 64 bit?	Attributes	Signed?	Object Start Version
Modbus	442	No	32 bit	No	M_01-03-00-000

Description

Position command derivative sign is multiplied by this value to be injected to the current command.

NOTE

IL.FRICTION is active in Position and Velocity modes (DRV.OPMODE = 1, 2), but not active in Torque mode (DRV.OPMODE = 0).

7.22.12 IL.IFOLD

General Information	
Type	R/O Parameter
Description	Reads the overall foldback current limit.
Units	A
Range	0 to 2,147,483.647 A
Default Value	N/A
Data Type	Float
Start Version	M_01-00-00-000

Variants Supported

Variant	Supported
AKD Base	Yes
AKD with Position Indexer	Yes
AKD EtherCAT	Yes
AKD CANopen	Yes
AKD BASIC	Yes
AKD SynqNet	Yes
AKD EtherNet/IP	Yes
AKD Profinet	Yes
AKD sercos [®] III	Yes
AKD-N	Yes
AKD-C	No

Fieldbus Information

Fieldbus	Index/Subindex	Object Start Version
EtherCAT COE and CANopen CANopen	3425h/0	M_01-00-00-000

Fieldbus	Address	Attributes	Signed?
Profinet	2222	DWord	No
sercos [®] III		4 Octets	

Fieldbus	Index/Subindex	Is 64 bit?	Attributes	Signed?	Object Start Version
Modbus	444	No	32 bit	No	M_01-03-00-000

Description

Two current foldback algorithms run in parallel in the drive: the drive foldback algorithm and the motor foldback algorithm. Each algorithm uses different sets of parameters.

Each algorithm has its own foldback current limit, IL.DIFOLD and IL.MIFOLD. The overall foldback current limit is the minimum of the two at any given moment.

$$IL.IFOLD = \min (IL.DIFOLD, IL.MIFOLD) .$$

IL.DIFOLD is an artificial current, which can be higher or lower than the drive or motor peak current. When IL.IFOLD becomes lower than the existing current limit (such as IL.LIMITP (pg 509)), it becomes the active current limit.

7.22.13 IL.IUFB

General Information	
Type	R/O Parameter
Description	Reads the sigma-delta measured current in the u-winding of the motor.
Units	A
Range	± Drive peak current (DRV.IPEAK)
Default Value	N/A
Data Type	Float
See Also	N/A
Start Version	M_01-00-00-000

Variants Supported

Variant	Supported
AKD Base	Yes
AKD with Position Indexer	Yes
AKD EtherCAT	Yes
AKD CANopen	Yes
AKD BASIC	Yes
AKD SynqNet	Yes
AKD EtherNet/IP	Yes
AKD Profinet	Yes
AKD sercos [®] III	Yes
AKD-N	Yes
AKD-C	No

Fieldbus Information

Fieldbus	Address	Attributes	Signed?
Profinet	2223	DWord	Yes
sercos [®] III		4 Octets	

Fieldbus	Index/Subindex	Is 64 bit?	Attributes	Signed?	Object Start Version
Modbus	446	No	32 bit	Yes	M_01-03-00-000

Description

This parameter displays the measured current in the u-winding of the motor.

7.22.14 IL.IVFB

General Information	
Type	R/O Parameter
Description	Sets the sigma-delta measured current in the u-winding of the motor.
Units	A
Range	± Drive peak current (DRV.IPEAK)
Default Value	0 A
Data Type	Float
See Also	N/A
Start Version	M_01-00-00-000

Variants Supported

Variant	Supported
AKD Base	Yes
AKD with Position Indexer	Yes
AKD EtherCAT	Yes
AKD CANopen	Yes
AKD BASIC	Yes
AKD SynqNet	Yes
AKD EtherNet/IP	Yes
AKD Profinet	Yes
AKD sercos [®] III	Yes
AKD-N	Yes
AKD-C	No

Fieldbus Information

Fieldbus	Address	Attributes	Signed?
Profinet	2224	DWord	Yes
sercos [®] III		4 Octets	

Fieldbus	Index/Subindex	Is 64 bit?	Attributes	Signed?	Object Start Version
Modbus	448	No	32 bit	Yes	M_01-03-00-000

Description

IL.IVFB is an offset value that is added to the measured current in the u-winding of the motor. This value is used for compensating for an error in the current measurement. The drive measures 256 times the current in the u-winding when powering-up the drive. Afterwards, the drive calculates the average value of the measured current and uses this value for the offset value.

7.22.15 IL.KACCFF

General Information	
Type	R/W Parameter
Description	Sets current loop acceleration feedforward gain value
Units	mArms/(rad/s ²)
Range	0.0 to 2.0 mArms/(rad/s ²)
Default Value	0 mArms/(rad/s ²)
Data Type	Float
See Also	IL.FF (pg 491)
Start Version	M_01-00-00-000

Variants Supported

Variant	Supported
AKD Base	Yes
AKD with Position Indexer	Yes
AKD EtherCAT	Yes
AKD CANopen	Yes
AKD BASIC	Yes
AKD SynqNet	Yes
AKD EtherNet/IP	Yes
AKD Profinet	Yes
AKD sercos [®] III	Yes
AKD-N	Yes
AKD-C	No

Fieldbus Information

Fieldbus	Index/Subindex	Object Start Version
EtherCAT COE and CANopen CANopen	3426h/0	M_01-00-00-000

Fieldbus	Address	Attributes	Signed?
Profinet	2225	DWord	Yes
sercos [®] III		4 Octets	

Fieldbus	Index/Subindex	Is 64 bit?	Attributes	Signed?	Object Start Version
Modbus	450	No	32 bit	Yes	M_01-03-00-000

Description

This value sets the gain for the acceleration feedforward (a scaled second derivative of the position command is added to the current command value).

This parameter is valid only in the position mode (DRV.OPMODE = 2).

7.22.16 IL.KBUSFF

General Information	
Type	NV Parameter
Description	Current loops fieldbus injected feed-forward gain
Units	NA
Range	0 to 2
Default Value	0
Data Type	Float
See Also	IL.FF (pg 491), IL.BUSFF (pg 485)
Start Version	M_01-00-00-000

Variants Supported

Variant	Supported
AKD Base	Yes
AKD with Position Indexer	Yes
AKD EtherCAT	Yes
AKD CANopen	Yes
AKD BASIC	Yes
AKD SynqNet	Yes
AKD EtherNet/IP	Yes
AKD Profinet	Yes
AKD sercos [®] III	Yes
AKD-N	Yes
AKD-C	No

Fieldbus Information

Fieldbus	Address	Attributes	Signed?
Profinet	2226	DWord	No
sercos [®] III		4 Octets	

Fieldbus	Index/Subindex	Is 64 bit?	Attributes	Signed?	Object Start Version
Modbus	452	No	32 bit	No	M_01-03-00-000

Description

This parameter scales the feedforward term added by the fieldbus to the current command. The nominal feedforward value can be multiplied by this gain value.

This parameter is only used in the position mode (DRV.OPMODE = 2).

7.22.17 IL.KP

General Information	
Type	NV Parameter
Description	Sets the proportional gain of the q-component of the PI regulator.
Units	V/A
Range	0 to 2,000 V/A
Default Value	Read from the motor or, if no memory, 50.009 V/A
Data Type	Float
See Also	N/A
Start Version	M_01-00-00-000

Variants Supported

Variant	Supported
AKD Base	Yes
AKD with Position Indexer	Yes
AKD EtherCAT	Yes
AKD CANopen	Yes
AKD BASIC	Yes
AKD SynqNet	Yes
AKD EtherNet/IP	Yes
AKD Profinet	Yes
AKD sercos [®] III	Yes
AKD-N	Yes
AKD-C	No

Fieldbus Information

Fieldbus	Index/Subindex	Object Start Version
EtherCAT COE and CANopen CANopen	3598h/0	M_01-00-00-000

Fieldbus	Address	Attributes	Signed?
Profinet	2227	Word	No
sercos [®] III		2 Octets	

Fieldbus	Index/Subindex	Is 64 bit?	Attributes	Signed?	Object Start Version
Modbus	454	No	16 bit	No	M_01-03-00-000

Description

IL.KP is used to modify the proportional gain of the PI-loop that controls the q-component of the current.

7.22.18 IL.KPDRATIO

General Information	
Type	NV Parameter
Description	Sets the proportional gain of the d-component current PI-regulator as a percentage of IL.KP
Units	N/A
Range	0 to 100
Default Value	1
Data Type	Float
See Also	IL.KP (pg 501)
Start Version	M_01-00-00-000

Variants Supported

Variant	Supported
AKD Base	Yes
AKD with Position Indexer	Yes
AKD EtherCAT	Yes
AKD CANopen	Yes
AKD BASIC	Yes
AKD SynqNet	Yes
AKD EtherNet/IP	Yes
AKD Profinet	Yes
AKD sercos [®] III	Yes
AKD-N	Yes
AKD-C	No

Fieldbus Information

Fieldbus	Index/Subindex	Object Start Version
EtherCAT COE and CANopen CANopen	3596h/0	M_01-00-00-000

Fieldbus	Address	Attributes	Signed?
Profinet	2228	DWord	No
sercos [®] III		4 Octets	

Fieldbus	Index/Subindex	Is 64 bit?	Attributes	Signed?	Object Start Version
Modbus	456	No	32 bit	No	M_01-03-00-000

Description

This parameter modifies the proportional gain of the PI-loop, which controls the d-component of the current.

7.22.19 IL.KPLOOKUPINDEX

General Information	
Type	R/W Parameter
Description	Sets the index into the Current Loop Gain Scheduling Table.
Units	N/A
Range	0 to 255
Default Value	0
Data Type	Integer
See Also	IL.KPLOOKUPVALUE (pg 504)IL.KPLOOKUPVALUES (pg 506)IL.KP (pg 501)
Start Version	M_01-04-00-000

Variants Supported

Variant	Supported
AKD Base	Yes
AKD with Position Indexer	Yes
AKD EtherCAT	Yes
AKD CANopen	Yes
AKD BASIC	Yes
AKD SynqNet	Yes
AKD EtherNet/IP	Yes
AKD Profinet	Yes
AKD sercos [®] III	Yes
AKD-N	Yes
AKD-C	No

Fieldbus Information

Fieldbus	Address	Attributes	Signed?
Profinet	2613	Word	No
sercos [®] III		2 Octets	

Fieldbus	Index/Subindex	Is 64 bit?	Attributes	Signed?
Modbus	1226	No	16 bit	No

Description

This parameter sets the index into the Current Loop Gain Scheduling Table. The table is 256 records long, spanning 0 A to 1.62 * DRV.IPEAK.

To determine the level of current that corresponds to a table index, use the following equation:

$$IL.CMD = (\text{Table Index} / 157) * \text{DRV.IPEAK}$$

7.22.20 IL.KPLOOKUPVALUE

General Information	
Type	R/W if motor memory not supported. R/O if motor memory supported.
Description	Sets the value of the current loop gain scheduling index.
Units	%
Range	0 to 100.000%
Default Value	0
Data Type	Float
See Also	IL.KPLOOKUPINDEX (pg 503), IL.KPLOOKUPVALUES (pg 506), IL.KP (pg 501)
Start Version	M_01-04-00-000

Variants Supported

Variant	Supported
AKD Base	Yes
AKD with Position Indexer	Yes
AKD EtherCAT	Yes
AKD CANopen	Yes
AKD BASIC	Yes
AKD SynqNet	Yes
AKD EtherNet/IP	Yes
AKD Profinet	Yes
AKD sercos [®] III	Yes
AKD-N	Yes
AKD-C	No

Fieldbus Information

Fieldbus	Address	Attributes	Signed?
Profinet	2614	DWord	No
sercos [®] III		4 Octets	

Fieldbus	Index/Subindex	Is 64 bit?	Attributes	Signed?
Modbus	1228	No	32 bit	No

Description

This parameter sets the value at the current index into the Current Loop Gain Scheduling Table. The table is 256 records long, spanning 0 A to 1.62 * DRV.IPEAK. The value can range from 0% to 100% and determines what percentage of IL.KP will be applied to the current loop.

If the feedback device supports motor memory (FB1.MEMVER >= 0.03 and MOTOR.AUTOSSET = 1) this parameter is read only. Each index value is automatically calculated and set. This calculation depends on the value of MOTOR.LISAT (pg 564).

If the feedback device does not support motor memory, this parameter is read/write. Each index value must be entered manually. Use the following equation to determine what level of current corresponds to a table index:

$$IL.CMD = (\text{Table Index}/157) * \text{DRV.IPEAK}$$

Example

Assume:

DRV.IPEAK = 9 A

IL.KPLOOKUPINDEX = 100

IL.KPLOOKUPVALUE = 50

IL.KP = 240

When $IL.CMD = 100/157 * 9 = 5.73$ A, IL.KP will not be 240, but will be $50\% * 240 = 120$.

7.22.21 IL.KPLOOKUPVALUES

General Information	
Type	R/W Parameter
Description	Gets the Current Loop Gain Scheduling Table.
Units	N/A
Range	N/A
Default Value	N/A
Data Type	Table
See Also	IL.KPLOOKUPINDEX (pg 503), IL.KPLOOKUPVALUE (pg 504), IL.KP (pg 501)
Start Version	M_01-04-00-000

Variants Supported

Variant	Supported
AKD Base	Yes
AKD with Position Indexer	Yes
AKD EtherCAT	Yes
AKD CANopen	Yes
AKD BASIC	Yes
AKD SynqNet	Yes
AKD EtherNet/IP	Yes
AKD Profinet	Yes
AKD sercos [®] III	Yes
AKD-N	Yes
AKD-C	No

Description

Retrieves the Current Loop Gain Scheduling Table in a comma delimited table.

This table is 256 records long, and the table will return values in the following format:

```
-->IL.KPLOOKUPVALUES
Index Value
0, 100.000
1, 100.000
2, 100.000
3, 100.000
4, 100.000
5, 100.000
6, 100.000
7, 100.000
8, 100.000
9, 100.000
10, 100.000
```

7.22.22 IL.KVFF

General Information	
Type	R/W
Description	Current loop velocity feed-forward gain.
Units	N/A
Range	0 to 2
Default Value	0
Data Type	Float
See Also	IL.FF (pg 491)
Start Version	M_01-00-00-000

Variants Supported

Variant	Supported
AKD Base	Yes
AKD with Position Indexer	Yes
AKD EtherCAT	Yes
AKD CANopen	Yes
AKD BASIC	Yes
AKD SynqNet	Yes
AKD EtherNet/IP	Yes
AKD Profinet	Yes
AKD sercos [®] III	Yes
AKD-N	Yes
AKD-C	No

Fieldbus Information

Fieldbus	Address	Attributes	Signed?
Profinet	2229	DWord	Yes
sercos [®] III		4 Octets	

Fieldbus	Index/Subindex	Is 64 bit?	Attributes	Signed?	Object Start Version
Modbus	458	No	32 bit	Yes	M_01-03-00-000

Description

This parameter sets the gain for the velocity loop feedforward. The nominal feedforward value can be multiplied by this gain value.

This parameter is only used in position mode (DRV.OPMODE (pg 370) = 2).

7.22.23 IL.LIMITN

General Information	
Type	NV Parameter
Description	Sets the negative user (application-specific) current limit.
Units	A
Range	Negative drive peak current (DRV.IPEAK) to 0 A
Default Value	Negative drive peak current (DRV.IPEAK)
Data Type	Float
See Also	IL.LIMITP (pg 509)
Start Version	M_01-00-00-000

Variants Supported

Variant	Supported
AKD Base	Yes
AKD with Position Indexer	Yes
AKD EtherCAT	Yes
AKD CANopen	Yes
AKD BASIC	Yes
AKD SynqNet	Yes
AKD EtherNet/IP	Yes
AKD Profinet	Yes
AKD sercos [®] III	Yes
AKD-N	Yes
AKD-C	No

Fieldbus Information

Fieldbus	Index/Subindex	Object Start Version
EtherCAT COE and CANopen CANopen	356Fh/0	M_01-00-00-000

Fieldbus	Address	Attributes	Signed?
Profinet	2230	DWord	Yes
sercos [®] III		4 Octets	

Fieldbus	Index/Subindex	Is 64 bit?	Attributes	Signed?	Object Start Version
Modbus	460	No	32 bit	Yes	M_01-03-00-000

Description

This parameter sets the negative user limit clamp value of the torqueproducing q-component current command (IL.CMD (pg 486)). The current command is additionally limited by the motor peak current setting (MOTOR.IPEAK (pg 560)) and by the present value of the foldback I_t peak motor current protection.

7.22.24 IL.LIMITP

General Information	
Type	NV Parameter
Description	Sets the positive user (application-specific) current limit.
Units	A
Range	0 A to drive peak current (DRV.IPEAK)
Default Value	Drive peak current (DRV.IPEAK)
Data Type	Float
See Also	IL.LIMITN (pg 508)
Start Version	M_01-00-00-000

Variants Supported

Variant	Supported
AKD Base	Yes
AKD with Position Indexer	Yes
AKD EtherCAT	Yes
AKD CANopen	Yes
AKD BASIC	Yes
AKD SynqNet	Yes
AKD EtherNet/IP	Yes
AKD Profinet	Yes
AKD sercos [®] III	Yes
AKD-N	Yes
AKD-C	No

Fieldbus Information

Fieldbus	Index/Subindex	Object Start Version
EtherCAT COE and CANopen CANopen	356Eh/0	M_01-00-00-000

Fieldbus	Address	Attributes	Signed?
Profinet	2231	DWord	Yes
sercos [®] III		4 Octets	

Fieldbus	Index/Subindex	Is 64 bit?	Attributes	Signed?	Object Start Version
Modbus	462	No	32 bit	Yes	M_01-03-00-000

Description

This parameter sets the positive user limit clamp value of the torque-producing q-component current command (IL.CMD (pg 486)). The current command is additionally limited by the motor peak current setting (MOTOR.IPEAK (pg 560)) and by the present value of the foldback I_t peak motor current protection.

7.22.25 IL.MFOLDD

General Information	
Type	R/O Parameter
Description	Sets the motor foldback maximum time at motor peak current.
Units	s
Range	0.1 to 2400 s
Default Value	10 s
Data Type	Float
Start Version	M_01-00-00-000

Variants Supported

Variant	Supported
AKD Base	Yes
AKD with Position Indexer	Yes
AKD EtherCAT	Yes
AKD CANopen	Yes
AKD BASIC	Yes
AKD SynqNet	Yes
AKD EtherNet/IP	Yes
AKD Profinet	Yes
AKD sercos [®] III	Yes
AKD-N	Yes
AKD-C	No

Fieldbus Information

Fieldbus	Address	Attributes	Signed?
Profinet	2232	DWord	No
sercos [®] III		4 Octets	

Fieldbus	Index/Subindex	Is 64 bit?	Attributes	Signed?	Object Start Version
Modbus	464	No	32 bit	No	M_01-03-00-000

Description

IL.MFOLDD sets the maximum time allowed for the motor to remain at peak current before starting to fold towards the motor continuous current. When at motor peak current, IL.MFOLDD is the amount of time before the foldback algorithm starts to reduce the current.

7.22.26 IL.MFOLDER

General Information	
Type	R/O Parameter
Description	Sets the motor foldback recovery time.
Units	s
Range	0.1 to 65,535 s
Default Value	Calculated from other foldback parameters.
Data Type	Float
Start Version	M_01-00-00-000

Variants Supported

Variant	Supported
AKD Base	Yes
AKD with Position Indexer	Yes
AKD EtherCAT	Yes
AKD CANopen	Yes
AKD BASIC	Yes
AKD SynqNet	Yes
AKD EtherNet/IP	Yes
AKD Profinet	Yes
AKD sercos [®] III	Yes
AKD-N	Yes
AKD-C	No

Fieldbus Information

Fieldbus	Address	Attributes	Signed?
Profinet	2233	DWord	No
sercos [®] III		4 Octets	

Fieldbus	Index/Subindex	Is 64 bit?	Attributes	Signed?	Object Start Version
Modbus	466	No	32 bit	No	M_01-03-00-000

Description

IL.MFOLDER sets the recovery time for the motor foldback algorithm. If 0 current is applied for at least the recovery time duration, it is possible to apply motor peak current for the duration of IL.MFOLDD time.

The IL.MFOLDER value is automatically calculated from other foldback parameters.

7.22.27 IL.MFOLDT

General Information	
Type	R/O Parameter
Description	Sets the motor foldback time constant of the exponential current drop (fold-back).
Units	s
Range	0.1 to 2,400 s
Default Value	10 s
Data Type	Float
Start Version	M_01-00-00-000

Variants Supported

Variant	Supported
AKD Base	Yes
AKD with Position Indexer	Yes
AKD EtherCAT	Yes
AKD CANopen	Yes
AKD BASIC	Yes
AKD SynqNet	Yes
AKD EtherNet/IP	Yes
AKD Profinet	Yes
AKD sercos [®] III	Yes
AKD-N	Yes
AKD-C	No

Fieldbus Information

Fieldbus	Address	Attributes	Signed?
Profinet	2234	DWord	No
sercos [®] III		4 Octets	

Fieldbus	Index/Subindex	Is 64 bit?	Attributes	Signed?	Object Start Version
Modbus	468	No	32 bit	No	M_01-03-00-000

Description

IL.MFOLDT sets the time constant of the exponential drop (foldback) of the current towards motor continuous current.

7.22.28 IL.MI2T

General Information	
Type	R/O parameter
Description	Motor I2t load.
Units	%
Range	0 to 100%
Default Value	N/A
Data Type	Float
See Also	IL.MIMODE, IL.MI2TWTRESH (pg 514)
Start Version	M_01-04-01-000

Variants Supported

Variant	Supported
AKD Base	Yes
AKD with Position Indexer	Yes
AKD EtherCAT	Yes
AKD CANopen	Yes
AKD BASIC	Yes
AKD SynqNet	Yes
AKD EtherNet/IP	Yes
AKD Profinet	Yes
AKD sercos [®] III	Yes
AKD-N	Yes
AKD-C	No

Fieldbus Information

Fieldbus	Address	Attributes	Signed?
Profinet	2592	Word	No
sercos [®] III		2 Octets	

Fieldbus	Index/Subindex	Is 64 bit?	Attributes	Signed?
Modbus	1184	No	16 bit	No

Description

This parameter returns the motor I2t load in percent. The supplied current will be limited by IL.MIFOLD to MOTOR.ICONT case that the load reaches a value of 100%. The current limit IL.MIFOLD will be restored to MOTOR.IPEAK in case that the load falls under 95%.

7.22.29 IL.MI2TWTRESH

General Information	
Type	NV Parameter
Description	Motor I2t load warning threshold.
Units	%
Range	0 to 100%
Default Value	N/A
Data Type	Integer
See Also	IL.MIMODE, IL.MI2T (pg 513)
Start Version	M_01-04-01-000

Variants Supported

Variant	Supported
AKD Base	Yes
AKD with Position Indexer	Yes
AKD EtherCAT	Yes
AKD CANopen	Yes
AKD BASIC	Yes
AKD SynqNet	Yes
AKD EtherNet/IP	Yes
AKD Profinet	Yes
AKD sercos [®] III	Yes
AKD-N	Yes
AKD-C	No

Fieldbus Information

Fieldbus	Address	Attributes	Signed?
Profinet	2834	Byte	No
sercos [®] III		2 Octets	

Fieldbus	Index/Subindex	Is 64 bit?	Attributes	Signed?	Object Start Version
Modbus	1668	No	8-bits	No	M_01-06-03-000

Description

This parameter defines a warning threshold for the IL.MI2T value. A warning n309 will be generated as soon as the IL.MI2T exceeds the IL.MI2TWTRESH value. The warning n309 will be cleared as soon as IL.MI2T falls below the threshold.

7.22.30 IL.MIFOLD

General Information	
Type	R/O Parameter
Description	Sets the motor foldback current limit.
Units	A
Range	0 to 2147483.647 A
Default Value	N/A
Data Type	Float
Start Version	M_01-00-00-000

Variants Supported

Variant	Supported
AKD Base	Yes
AKD with Position Indexer	Yes
AKD EtherCAT	Yes
AKD CANopen	Yes
AKD BASIC	Yes
AKD SynqNet	Yes
AKD EtherNet/IP	Yes
AKD Profinet	Yes
AKD sercos [®] III	Yes
AKD-N	Yes
AKD-C	No

Fieldbus Information

Fieldbus	Index/Subindex	Object Start Version
EtherCAT COE and CANopen CANopen	35A4h/0	M_01-00-00-000

Fieldbus	Address	Attributes	Signed?
Profinet	2235	DWord	No
sercos [®] III		4 Octets	

Fieldbus	Index/Subindex	Is 64 bit?	Attributes	Signed?	Object Start Version
Modbus	470	No	32 bit	No	M_01-03-00-000

Description

IL.MIFOLD sets the output of the motor foldback algorithm. It is an artificial current, which can be higher or lower than the motor peak current. When IL.MIFOLD becomes lower than the existing current limit (IL.LIMITP (pg 509)) it becomes the active current limit.

IL.MIFOLD decreases when the actual current is higher than motor continuous current and increases (up to a certain level) when the actual current is lower than the motor continuous current.

7.22.31 IL.MIMODE

General Information	
Type	NV parameter
Description	Motor protection mode.
Units	N/A
Range	0 to 1
Default Value	0
Data Type	Integer
See Also	IL.MI2T (pg 513), _IL.MI2TWTRESH (pg 514)
Start Version	M_01-04-01-000

Variants Supported

Variant	Supported
AKD Base	Yes
AKD with Position Indexer	Yes
AKD EtherCAT	Yes
AKD CANopen	Yes
AKD BASIC	Yes
AKD SynqNet	Yes
AKD EtherNet/IP	Yes
AKD Profinet	Yes
AKD sercos [®] III	Yes
AKD-N	Yes
AKD-C	No

Fieldbus Information

Fieldbus	Index/Subindex	Is 64 bit?	Attributes	Signed?	Object Start Version
Modbus	1670	No	8-bits	No	M_01-06-03-000

Description

This parameter determines the method of the motor protection.

0 – The motor foldback mechanism is responsible for protecting the motor from overload.

1 – The motor I2t mechanism is responsible for protecting the motor from overload.

7.22.32 IL.OFFSET

General Information	
Type	RW Parameter
Description	A constant current command added to compensate for gravity.
Units	A
Range	[IL.LIMITN (pg 508) to IL.LIMITP (pg 509)
Default Value	0 A
Data Type	Float
See Also	IL.FF
Start Version	M_01-00-00-000

Variants Supported

Variant	Supported
AKD Base	Yes
AKD with Position Indexer	Yes
AKD EtherCAT	Yes
AKD CANopen	Yes
AKD BASIC	Yes
AKD SynqNet	Yes
AKD EtherNet/IP	Yes
AKD Profinet	Yes
AKD sercos [®] III	Yes
AKD-N	Yes
AKD-C	No

Fieldbus Information

Fieldbus	Index/Subindex	Object Start Version
EtherCAT COE and CANopen CANopen	3423h/0	M_01-00-00-000

Fieldbus	Address	Attributes	Signed?
Profinet	2236	DWord	Yes
sercos [®] III		4 Octets	

Fieldbus	Index/Subindex	Is 64 bit?	Attributes	Signed?	Object Start Version
Modbus	472	No	32 bit	Yes	M_01-03-00-000

Description

This value is added to the overall current loop feedforward value.

7.22.33 IL.VCMD

General Information	
Type	R/O Parameter
Description	Sets the output of the q-component PI regulator.
Units	Vrms
Range	0 Vrms to bus voltage
Default Value	N/A
Data Type	Integer
Start Version	M_01-00-00-000

Variants Supported

Variant	Supported
AKD Base	Yes
AKD with Position Indexer	Yes
AKD EtherCAT	Yes
AKD CANopen	Yes
AKD BASIC	Yes
AKD SynqNet	Yes
AKD EtherNet/IP	Yes
AKD Profinet	Yes
AKD sercos [®] III	Yes
AKD-N	Yes
AKD-C	No

Fieldbus Information

Fieldbus	Address	Attributes	Signed?
Profinet	2237	Word	Yes
sercos [®] III		2 Octets	

Fieldbus	Index/Subindex	Is 64 bit?	Attributes	Signed?	Object Start Version
Modbus	474	No	16 bit	Yes	M_01-03-00-000

Description

Sets the output of the current loop that controls the q-component of the current.

7.22.34 IL.VUFB

General Information	
Type	R/O Parameter
Description	Reads the measured voltage on the u-winding of the motor.
Units	V
Range	-1200*VBusScale to +1200*VBusScale
Default Value	N/A
Data Type	Integer
See Also	IL.VVFB (pg 520)
Start Version	M_01-00-00-000

Variants Supported

Variant	Supported
AKD Base	Yes
AKD with Position Indexer	Yes
AKD EtherCAT	Yes
AKD CANopen	Yes
AKD BASIC	Yes
AKD SynqNet	Yes
AKD EtherNet/IP	Yes
AKD Profinet	Yes
AKD sercos [®] III	Yes
AKD-N	Yes
AKD-C	No

Fieldbus Information

Fieldbus	Address	Attributes	Signed?
Profinet	2238	Word	Yes
sercos [®] III		2 Octets	

Fieldbus	Index/Subindex	Is 64 bit?	Attributes	Signed?	Object Start Version
Modbus	476	No	16 bit	Yes	M_01-03-00-000

Description

Reads the measured voltage on the u-winding of the motor.

7.22.35 IL.VVFB

General Information	
Type	R/O Parameter
Description	Reads the measured voltage on the v-winding of the motor.
Units	V
Range	-1200*VBusScale to +1200*VBusScale
Default Value	N/A
Data Type	Integer
See Also	IL.VUFB (pg 519)
Start Version	M_01-00-00-000

Variants Supported

Variant	Supported
AKD Base	Yes
AKD with Position Indexer	Yes
AKD EtherCAT	Yes
AKD CANopen	Yes
AKD BASIC	Yes
AKD SynqNet	Yes
AKD EtherNet/IP	Yes
AKD Profinet	Yes
AKD sercos [®] III	Yes
AKD-N	Yes
AKD-C	No

Fieldbus Information

Fieldbus	Address	Attributes	Signed?
Profinet	2239	Word	Yes
sercos [®] III		2 Octets	

Fieldbus	Index/Subindex	Is 64 bit?	Attributes	Signed?	Object Start Version
Modbus	478	No	16 bit	Yes	M_01-03-00-000

Description

The range for this parameter depends on whether the drive model is an MV/240 VAC or an HV/480 VAC.

The VBusScale parameter sets the drive model:

MV/240 VAC: VBusScale = 1

HV/480 VAC: VBusScale = 2

VBusScale is used for multiple parameter ranges that are model dependent, such as IL.KP.

7.23 IP Parameters

This section describes the IP parameters.

7.23.1 IP.ADDRESS	522
7.23.2 IP.GATEWAY	524
7.23.3 IP.MODE	526
7.23.4 IP.RESET	528
7.23.5 IP.SUBNET	530

7.23.1 IP.ADDRESS

General Information	
Type	NV Parameter
Description	Gets/Sets the IP address of the drive.
Units	N/A
Range	0.0.0.0 to 255.255.255.255
Default Value	0.0.0.0
Data Type	IP Address
See Also	
Start Version	M_01-04-05-000

Variants Supported

Variant	Supported
AKD Base	Yes
AKD with Position Indexer	Yes
AKD EtherCAT	Yes
AKD CANopen	Yes
AKD BASIC	Yes
AKD SynqNet	Yes
AKD EtherNet/IP	Yes
AKD Profinet	Yes
AKD sercos [®] III	Yes
AKD-N	Yes
AKD-C	Yes

Description

This Parameter sets the IP address of the drive. If this parameter has not been set by the user, it will return 0.0.0.0.

By default, DHCP is active, and the drive will acquire an IP Address on its own. When the drive is in DHCP mode, IP.ADDRESS will return 0.0.0.0.

Notes:

- Even when the drive is in DHCP, the actual IP Address will not be returned using this command. The value the user has stored will be returned.
- IP.ADDRESS will only be used by the drive when IP.MODE = 1

If manually setting the IP.ADDRESS, the IP.SUBNET and IP.GATEWAY must be set up. After the IP.RESET command is issued, the new IP settings will be active only if IP.MODE has been set to 1.

Recovering communications with a drive on an un-reachable IP address

Sometimes a drive may be configured for an IP Address, and the drive needs to be taken off-line, and bench tested, or otherwise used outside of its saved IP Settings. If IP.MODE has been set to 1 (using software defined static IP) the drive will boot up on an IP Address that may be unreachable with the host computer's settings.

If the IP address prevents communication the IP settings can be reset to default by the following procedure:

- Set both rotary switches to 0
- Hold down button B1 (top-side of drive) for 5 seconds.

The display will flash 0.0.0.0 and then attempt to discover an address by DHCP. Without removing logic power from the drive, use Workbench to connect to the drive, reconfigure the IP address settings as desired, and store the values to non-volatile memory.

Related Topics

IP.GATEWAY | IP.RESET | IP.SUBNET | IP.MODE

7.23.2 IP.GATEWAY

General Information	
Type	NV Parameter
Description	Gets/Sets the gateway IP of the drive.
Units	N/A
Range	0.0.0.0 to 255.255.255.255
Default Value	0.0.0.0
Data Type	IP Address
See Also	Communicating with the Drive
Start Version	M_01-04-05-000

Variants Supported

Variant	Supported
AKD Base	Yes
AKD with Position Indexer	Yes
AKD EtherCAT	Yes
AKD CANopen	Yes
AKD BASIC	Yes
AKD SynqNet	Yes
AKD EtherNet/IP	Yes
AKD Profinet	Yes
AKD sercos [®] III	Yes
AKD-N	Yes
AKD-C	Yes

Description

This Parameter sets the Gateway IP of the drive. This parameter determines what IP the drive can communicate with outside of its current subnet.

By default, DHCP is active, and the drive will acquire an IP Address on its own. When the drive is in DHCP mode, IP.GATEWAY will return 0.0.0.0.

Notes:

- When the drive is in DHCP, the actual IP GATEWAY will not be returned using this command. The value the user has stored will be returned.
- IP.GATEWAY will only be used by the drive when IP.MODE = 1

If manually setting the IP.ADDRESS (pg 522), the IP.SUBNET (pg 530) and IP.GATEWAY must be set up. After the IP.RESET (pg 528) command is issued, the new IP settings will be active only if IP.MODE (pg 526) has been set to 1.

Recovering communications with a drive on an un-reachable IP address

Sometimes a drive may be configured for an IP Address, and the drive needs to be taken off-line, and bench tested, or otherwise used outside of its saved IP Settings. If IP.MODE has been set to 1 (using software defined static IP) the drive will boot up on an IP Address that may be unreachable with the host computer's settings.

If the IP address prevents communication the IP settings can be reset to default by the following procedure:

- Set both rotary switches to 0
- Hold down button B1 (top-side of drive) for 5 seconds.

The display will flash 0.0.0.0 and then attempt to discover an address by DHCP. Without removing logic power from the drive, use Workbench to connect to the drive, reconfigure the IP address settings as desired, and store the values to non-volatile memory.

Related Topics

[IP.ADDRESS \(pg 522\)](#) | [IP.RESET \(pg 528\)](#) | [IP.SUBNET \(pg 530\)](#) | [IP.MODE \(pg 526\)](#)

7.23.3 IP.MODE

General Information	
Type	NV Parameter
Description	Sets method of acquiring IP Address.
Units	N/A
Range	0 to 2
Default Value	0
Data Type	Integer
See Also	N/A
Start Version	M_01-04-013-000

Variants Supported

Variant	Supported
AKD Base	Yes
AKD with Position Indexer	Yes
AKD EtherCAT	Yes
AKD CANopen	Yes
AKD BASIC	Yes
AKD SynqNet	Yes
AKD EtherNet/IP	Yes
AKD Profinet	Yes
AKD sercos [®] III	Yes
AKD-N	Yes
AKD-C	Yes

Fieldbus Information

Fieldbus	Address	Attributes	Signed?
Profinet	2606	Word	No
sercos [®] III		2 Octets	

Fieldbus	Index/Subindex	Is 64 bit?	Attributes	Signed?
Modbus	1212	No	16 bit	No

Description

This command determines which method of acquiring an IP Address the drive will take.

NOTE

Mode 0 and Mode 1 contain multiple methods of acquiring an IP Address. In these modes each method will be implemented in the order they are listed below until an IP Address is acquired

The drive will attempt to acquire a new IP Address as soon as the IP.RESET (pg 528) command is issued.

IP Mode	Mode of Acquiring IP Address
0	Rotary Switches, DHCP, Auto IP
1	IP.ADDRESS, IP.SUBNET, IP.GATEWAY
2	DHCP, Auto IP

Recovering communications with a drive on an un-reachable IP address

Sometimes a drive may be configured for an IP Address, and the drive needs to be taken off-line, and bench tested, or otherwise used outside of its saved IP Settings. If IP.MODE has been set to 1 (using software defined static IP), the drive will boot up on an IP Address that may be unreachable with the host computer's settings.

If the IP address prevents communication the IP settings can be reset to default by the following procedure:

- Set both rotary switches to 0
- Hold down button B1 (top-side of drive) for 5 seconds.

The display will flash 0.0.0.0 and then attempt to discover an address by DHCP. Without removing logic power from the drive, use Workbench to connect to the drive, reconfigure the IP address settings as desired, and store the values to non-volatile memory.

Related Topics

IP.ADDRESS (pg 522)

IP.GATEWAY (pg 524)

IP.RESET (pg 528)

IP.SUBNET (pg 530)

7.23.4 IP.RESET

General Information	
Type	Command
Description	Implements new IP settings.
Units	N/A
Range	N/A
Default Value	N/A
Data Type	N/A
See Also	Communicating with the Drive
Start Version	M_01-04-05-000

Variants Supported

Variant	Supported
AKD Base	Yes
AKD with Position Indexer	Yes
AKD EtherCAT	Yes
AKD CANopen	Yes
AKD BASIC	Yes
AKD SynqNet	Yes
AKD EtherNet/IP	Yes
AKD Profinet	Yes
AKD sercos [®] III	Yes
AKD-N	Yes
AKD-C	Yes

Fieldbus Information

Fieldbus	Address	Attributes	Signed?
Profinet	2836	Command	No
sercos [®] III			

Fieldbus	Index/Subindex	Is 64 bit?	Attributes	Signed?	Object Start Version
Modbus	1672	No	Command	No	M_01-06-03-000

Description

When this command is issued a new IP will be acquired using IP.MODE (pg 526) to select what method is used.

Notes:

- When issuing this command, it is likely the connection to the drive will be severed, and a new connection will need to be made.
- IP.RESET will return an error if issued while the drive is enabled. IP.RESET is allowed when drive is disabled, or in dynamic braking mode.
- Ensure all values of IP.ADDRESS (pg 522), IP.SUBNET (pg 530), and IP.GATEWAY (pg 524) are configured if using IP.MODE 1

Recovering communications with a drive on an un-reachable IP address

Sometimes a drive may be configured for an IP Address, and the drive needs to be taken off-line, and bench tested, or otherwise used outside of its saved IP Settings. If IP.MODE has been set to 1 (using software defined static IP), the drive will boot up on an IP Address that may be unreachable with the host computer's settings.

If the IP address prevents communication the IP settings can be reset to default by the following procedure:

- Set both rotary switches to 0
- Hold down button B1 (top-side of drive) for 5 seconds.

The display will flash 0.0.0.0 and then attempt to discover an address by DHCP. Without removing logic power from the drive, use Workbench to connect to the drive, reconfigure the IP address settings as desired, and store the values to non-volatile memory.

Related Topics

IP.ADDRESS (pg 522) | IP.GATEWAY (pg 524) | IP.SUBNET (pg 530) | IP.MODE

7.23.5 IP.SUBNET

General Information	
Type	NV Parameter
Description	Gets/Sets the IP Subnet mask of the drive.
Units	N/A
Range	0.0.0.0 to 255.255.255.255
Default Value	0.0.0.0
Data Type	IP Address
See Also	
Start Version	M_01-04-05-000

Variants Supported

Variant	Supported
AKD Base	Yes
AKD with Position Indexer	Yes
AKD EtherCAT	Yes
AKD CANopen	Yes
AKD BASIC	Yes
AKD SynqNet	Yes
AKD EtherNet/IP	Yes
AKD Profinet	Yes
AKD sercos [®] III	Yes
AKD-N	Yes
AKD-C	Yes

Description

This Parameter sets the IP Subnet mask of the drive. This parameter determines what IP addresses the drive will be allowed to communicate with.

By default, DHCP is active, and the drive will acquire an IP Address on its own. When the drive is in DHCP mode, IP.SUBNET will return 0.0.0.0.

Notes:

- When the drive is in DHCP, the actual IP Subnet mask will not be returned using this command. The value the user has stored will be returned.
- IP.SUBNET will only be used by the drive when IP.MODE = 1

If manually setting the IP.ADDRESS, the IP.SUBNET and IP.GATEWAY must be set up. After the IP.RESET command is issued, the new IP settings will be active only if IP.MODE has been set to 1.

Recovering communications with a drive on an un-reachable IP address

Sometimes a drive may be configured for an IP Address, and the drive needs to be taken off-line, and bench tested, or otherwise used outside of its saved IP Settings. If IP.MODE has been set to 1 (using software defined static IP) the drive will boot up on an IP Address that may be unreachable with the host computer's settings.

If the IP address prevents communication the IP settings can be reset to default by the following procedure:

- Set both rotary switches to 0
- Hold down button B1 (top-side of drive) for 5 seconds.

The display will flash 0.0.0.0 and then attempt to discover an address by DHCP. Without removing logic power from the drive, use Workbench to connect to the drive, reconfigure the IP address settings as desired, and store the values to non-volatile memory.

Related Topics

[IP.ADDRESS](#) | [IP.GATEWAY](#) | [IP.RESET](#) | [7.23.3 IP.MODE](#)

7.24 INTR Parameters

This section describes the INTR parameters.

7.24.1 Interrupt {Source}	533
7.24.2 Interrupt...End Interrupt	535

7.24.1 Interrupt {Source}

General Information	
Type	R/W
Description	Interrupt sources enable or disable Interrupt...End Interrupt (pg 535) statements.
Units	none
Range	0 (disabled) or 1 (enabled)
Default Value	0 (disabled)
Data Type	Integer

Description

Interrupt sources enable or disable Interrupt ... End Interrupt statements. If you enable a given interrupt then there must be an Interrupt ... End Interrupt definition for that interrupt source in your program.

The table below lists the source names and a brief description for all the interrupt sources available on the AKD BASIC.

Interrupt Source	Interrupt Occurs
INTR.DIN1HI	when DIN1.STATE goes from 0 to 1
INTR.DIN1LO	when DIN1.STATE goes from 1 to 0
INTR.DIN2HI	when DIN2.STATE goes from 0 to 1
INTR.DIN2LO	when DIN2.STATE goes from 1 to 0
INTR.DIN3HI	when DIN3.STATE goes from 0 to 1
INTR.DIN3LO	when DIN3.STATE goes from 1 to 0
INTR.DIN4HI	when DIN4.STATE goes from 0 to 1
INTR.DIN4LO	when DIN4.STATE goes from 1 to 0
INTR.DIN5HI	when DIN5.STATE goes from 0 to 1
INTR.DIN5LO	when DIN5.STATE goes from 1 to 0
INTR.DIN6HI	when DIN6.STATE goes from 0 to 1
INTR.DIN6LO	when DIN6.STATE goes from 1 to 0
INTR.DIN7HI	when DIN7.STATE goes from 0 to 1
INTR.DIN7LO	when DIN7.STATE goes from 1 to 0
INTR.DIN21HI	when DIN21.STATE goes from 0 to 1
INTR.DIN21LO	when DIN21.STATE goes from 1 to 0
INTR.DIN22HI	when DIN22.STATE goes from 0 to 1
INTR.DIN22LO	when DIN22.STATE goes from 1 to 0
INTR.DIN23HI	when DIN23.STATE goes from 0 to 1
INTR.DIN23LO	when DIN23.STATE goes from 1 to 0
INTR.DIN24HI	when DIN24.STATE goes from 0 to 1
INTR.DIN24LO	when DIN24.STATE goes from 1 to 0
INTR.DIN25HI	when DIN25.STATE goes from 0 to 1
INTR.DIN25LO	when DIN25.STATE goes from 1 to 0
INTR.DIN26HI	when DIN26.STATE goes from 0 to 1
INTR.DIN26LO	when DIN26.STATE goes from 1 to 0
INTR.DIN27HI	when DIN27.STATE goes from 0 to 1
INTR.DIN27LO	when DIN27.STATE goes from 1 to 0
INTR.DIN28HI	when DIN28.STATE goes from 0 to 1

Interrupt Source	Interrupt Occurs
INTR.DIN28LO	when DIN28.STATE goes from 1 to 0
INTR.DIN29HI	when DIN29.STATE goes from 0 to 1
INTR.DIN29LO	when DIN29.STATE goes from 1 to 0
INTR.DIN30HI	when DIN30.STATE goes from 0 to 1
INTR.DIN30LO	when DIN30.STATE goes from 1 to 0
INTR.DIN31HI	when DIN31.STATE goes from 0 to 1
INTR.DIN31LO	when DIN31.STATE goes from 1 to 0
INTR.DISABLE	when the drive gets disabled
INTR.DRV.FAULTS	when the drive faults
INTR.DRV.HWENABLE	when DRV.HWENABLE goes from 0 to 1
INTR.DRV.WARNINGS	when the drive produces a warning
INTR.HWLS.NEGSTATE	when HWLS.NEGSTATE goes from 0 to 1
INTR.HWLS.POSSTATE	when HWLS.POSSTATE goes from 0 to 1
INTR.MOVBUS	when a Modbus User Parameter changes.
INTR.MSG	when a character is received.
INTR.PL.ERR	when PL.ERR = PL.ERRFTHRESH
INTR.PLS.P1 to INTR.PLS.P8	when PLS.P1 to PLS.P8 is enabled and goes high, respectively.
INTR.SWLS.LIMIT0	when PL.FB > SWLS.LIMIT0 (if SWLS.LIMIT0 is the upper limit)
INTR.SWLS.LIMIT1	when PL.FB < SWLS.LIMIT1 (if SWLS.LIMIT1 is the lower limit)
INTR.TIMER	after a number of milliseconds specified by VM.INTRTIMER (VM.INTRTIMER must be set before setting INTR.TIMER = 1).

Example

```

Main
  DRV.TIME = 0
  INTR.DIN1LO = 1
  while 1
    pause (0.5)
    DOUT1.STATE=0 : Pause (0.005) : DOUT1.STATE=1
  wend
end main
'----- Interrupt Routines -----'
Interrupt DIN1LO
  print "I'm awake"
  If DRV.TIME > 10 then
    print "OK. That's it."
  else
    INTR.DIN1LO = 1
  end if
End Interrupt

```

Related Topics

Interrupt...End Interrupt (pg 535)

7.24.2 Interrupt...End Interrupt

General Information	
Type	Statement
Description	The interrupt feature permits execution of a user-defined subroutine upon receipt of a hardware interrupt signal or a pre-defined interrupt event.
Units	N/A
Range	N/A
Default Value	N/A
Data Type	N/A

Description

The Interrupt statment marks the beginning of an Interrupt Service Routine. The Interrupt Service Routine is defined by a program structure resembling a subroutine. The interrupt feature permits execution of a user-defined subroutine upon receipt of a hardware interrupt signal or a pre-defined interrupt event.

Interrupts are triggered by pre-defined events or external hardware sources. The interrupt-source-name and interrupt enable flag are unique for each interrupt source.

Receiving an interrupt will suspend program execution and the interrupt service routine will be executed. Then program execution will resume at the point that it was interrupted.

Interrupts are enabled (or disabled) by setting (or clearing) the associated interrupt enable flag. Interrupts are disabled until explicitly enabled. After an interrupt is triggered it is automatically disabled until it is enabled again in your program.

Example

```

Main
  DRV.TIME = 0
  INTR.DIN1LO = 1
  while 1
    pause(0.5)
    DOUT1.STATE=0 : Pause(0.005) : DOUT1.STATE=1
  wend
end main
'----- Interrupt Routines -----
Interrupt DIN1LO
  print "I'm awake"
  If DRV.TIME > 10 then
    print "OK. That's it."
  else
    INTR.DIN1LO = 1
  end if
End Interrupt

```

Related Topics

Interrupt {Source} (pg 533) | Sub...End Sub (pg 138) | Restart (pg 134)

7.25 LOAD-Parameter

This section describes the LOAD parameters.

7.25.1 LOAD.INERTIA	537
----------------------------------	------------

7.25.1 LOAD.INERTIA

General Information	
Type	NV Parameter
Description	Sets the load inertia.
Units	kgcm ² for rotary motors kg for linear motors
Range	1 to 1,000,000 kgcm ² or kg
Default Value	0 kgcm ² or kg
Data Type	Float
See Also	N/A
Start Version	M_01-03-06-000

Variants Supported

Variant	Supported
AKD Base	Yes
AKD with Position Indexer	Yes
AKD EtherCAT	Yes
AKD CANopen	Yes
AKD BASIC	Yes
AKD SynqNet	Yes
AKD EtherNet/IP	Yes
AKD Profinet	Yes
AKD sercos [®] III	Yes
AKD-N	Yes
AKD-C	No

Fieldbus Information

Fieldbus	Address	Attributes	Signed?
Profinet	2607	DWord	No
sercos [®] III		4 Octets	

Fieldbus	Index/Subindex	Is 64 bit?	Attributes	Signed?
Modbus	1214	No	32 bit	No

Description

LOAD.INERTIA sets the load inertia.

7.26 MODBUS Paramters

This section describes the MODBUS parameters.

7.26.1 MODBUS.PIN	539
7.26.2 MODBUS.POUT	541
7.26.3 MODBUS.PSCALE	543
7.26.4 MODBUS.SCALING	545

7.26.1 MODBUS.PIN

General Information	
Type	R/W
Description	Gets / Sets the Modbus User Units Input parameter.
Units	N/A
Range	1 to 4294967295
Default Value	1
Data Type	Integer
Start Version	M_01-04-00-000

Variants Supported

Variant	Supported
AKD Base	Yes
AKD with Position Indexer	Yes
AKD EtherCAT	Yes
AKD CANopen	Yes
AKD BASIC	Yes
AKD SynqNet	Yes
AKD EtherNet/IP	Yes
AKD Profinet	No
AKD sercos [®] III	Yes
AKD-N	No
AKD-C	No

Fieldbus Information

Fieldbus	Address	Attributes	Signed?
Profinet	2487	DWord	No
sercos [®] III		4 Octets	

Fieldbus	Index/Subindex	Is 64 bit?	Attributes	Signed?
Modbus	974	No	32 bit	No

Description

MODBUS.PIN and MODBUS.POUT (pg 541) are used to apply user specified units to the feedback values retrieved over Modbus.

To use this parameter correctly, first the MODBUS.PSCALE (pg 543) must be known, this value determines the resolution per revolution of the motor for Modbus. Then the ratio of MODBUS.POUT (pg 541) /MODBUS.PIN is applied to convert counts/rev into User Units/rev.

Example

Use Modbus Scaling to return feedback in Radians

```
MODBUS.PSCALE = 16 (65536 counts/rev or pole pitch)
MODBUS.PIN = 5215189
MODBUS.POUT = 500000
```

If the motor is currently resting with a Modbus raw position 36,462 Counts (MODBUS.PSCALE (pg 543) is set to return 65,536 per rev) and the user requests the position using PL.FB over Modbus, the position will be returned as:

$$36,462 * 500000 / 5215189 = 3495 \text{ (Radians * 1000)}$$

Which equals 3.495 Radians

Related Topics

MODBUS.PSCALE (pg 543)

MODBUS.POUT (pg 541)

7.26.2 MODBUS.POUT

General Information	
Type	R/W
Description	Gets / Sets the Modbus User Units Output parameter.
Units	N/A
Range	1 to 4294967295
Default Value	1
Data Type	Integer
Start Version	M_01-04-00-000

Variants Supported

Variant	Supported
AKD Base	Yes
AKD with Position Indexer	Yes
AKD EtherCAT	Yes
AKD CANopen	Yes
AKD BASIC	Yes
AKD SynqNet	Yes
AKD EtherNet/IP	Yes
AKD Profinet	No
AKD sercos [®] III	Yes
AKD-N	No
AKD-C	No

Fieldbus Information

Fieldbus	Address	Attributes	Signed?
Profinet	2488	DWord	No
sercos [®] III		4 Octets	

Fieldbus	Index/Subindex	Is 64 bit?	Attributes	Signed?
Modbus	976	No	32 bit	No

Description

MODBUS.PIN (pg 539) and MODBUS.POUT are used to apply User specified Units to the feedback values retrieved over Modbus.

To use this parameter correctly, first the MODBUS.PSCALE (pg 543) must be known. This value determines the resolution per revolution of the motor for Modbus. Then the ratio of MODBUS.POUT/MODBUS.PIN (pg 539) is applied to convert counts/rev into User Units/rev.

Example: Use Modbus Scaling to return feedback in Radians

```
MODBUS.PSCALE = 16 (65536 counts/rev or pole pitch)
MODBUS.PIN = 5215189
MODBUS.POUT = 500000
```

If the motor is currently resting with a Modbus raw position 36,462 Counts (MODBUS.PSCALE (pg 543) is set to return 65,536 per rev) and the user requests the position using PL.FB over Modbus, the position will be returned as:

$$36,462 * 500000 / 5215189 = 3495 \text{ (Radians * 1000)}$$

Which equals 3.495 Radians

Related Topics

MODBUS.PSCALE (pg 543)

MODBUS.PIN (pg 539)

7.26.3 MODBUS.PSCALE

General Information	
Type	R/W
Description	Gets/Sets the Feedback Resolution (per rev) over Modbus.
Units	
Range	10 to 31
Default Value	20
Data Type	Integer
See Also	N/A
Start Version	M_01-04-00-000

Variants Supported

Variant	Supported
AKD Base	Yes
AKD with Position Indexer	Yes
AKD EtherCAT	Yes
AKD CANopen	Yes
AKD BASIC	Yes
AKD SynqNet	Yes
AKD EtherNet/IP	Yes
AKD Profinet	No
AKD sercos [®] III	Yes
AKD-N	No
AKD-C	No

Fieldbus Information

Fieldbus	Address	Attributes	Signed?
Profinet	2489	DWord	No
sercos [®] III		4 Octets	

Fieldbus	Index/Subindex	Is 64 bit?	Attributes	Signed?
Modbus	978	No	16 bit	No

Description

This parameter determines the number of encoder counts per mechanical revolution reported over Modbus.

$$\text{Modbus Resolution} = 2^{(\text{MODBUS.PSCALE})}$$

Notes:

- This scaling affects Position, Velocity and Acceleration when reading values over Modbus. This scaling term does not affect units over any other communication.

- Additionally, see MODBUS.PIN (pg 539) and MODBUS.POUT (pg 541), as these are applied on top of MODBUS.PSCALE to allow for user customizable units.

Related Topics

MODBUS.POUT (pg 541)

MODBUS.PIN (pg 539)

7.26.4 MODBUS.SCALING

General Information	
Type	NV Parameter
Description	Selects the scaling mode for Modbus values.
Units	N/A
Range	0 to 1
Default Value	1
Data Type	U8
Start Version	M_01-04-15-000

Variants Supported

Variant	Supported
AKD Base	Yes
AKD with Position Indexer	Yes
AKD EtherCAT	Yes
AKD CANopen	Yes
AKD BASIC	Yes
AKD SynqNet	Yes
AKD EtherNet/IP	Yes
AKD Profinet	No
AKD sercos [®] III	Yes
AKD-N	Yes
AKD-C	No

Fieldbus Information

Fieldbus	Address	Attributes	Signed?
Profinet	2524	Byte	No
sercos [®] III		2 Octets	

Fieldbus	Index/Subindex	Is 64 bit?	Attributes	Signed?
Modbus	1048	No	8 bit	No

Description

Modbus has its own scaling algorithms. For some simple HMI's, it is desirable to use Workbench units instead of these Modbus-specific units. The parameter MODBUS.SCALING allows users to disable Modbus scaling and enable WB (Telnet) scaling.

Setting	Description
0	Modbus uses same scaling units as Workbench (set by UNIT parameters)
1	Modbus uses the Modbus-specific scaling units (set by MODBUS parameters)

Related Topics

UNIT Parameters (pg 711)

7.27 MOTOR Parameters

This section describes the MOTOR parameters.

7.27.1 MOTOR.AUTOSET	548
7.27.2 MOTOR.BRAKE	550
7.27.3 MOTOR.BRAKEIMM	552
7.27.4 MOTOR.BRAKERLS	553
7.27.5 MOTOR.BRAKESTATE	554
7.27.6 MOTOR.CTF0	555
7.27.7 MOTOR.ICONT	556
7.27.8 MOTOR.IDDATAVALID	557
7.27.9 MOTOR.IDMAX	558
7.27.10 MOTOR.INERTIA	559
7.27.11 MOTOR.IPEAK	560
7.27.12 MOTOR.KE	561
7.27.13 MOTOR.KT	562
7.27.14 MOTOR.LDLL	563
7.27.15 MOTOR.LISAT	564
7.27.16 MOTOR.LQLL	565
7.27.17 MOTOR.NAME	566
7.27.18 MOTOR.PHASE	567
7.27.19 MOTOR.PHSADV1	568
7.27.20 MOTOR.PHSADV2	569
7.27.21 MOTOR.PITCH	570
7.27.22 MOTOR.POLES	571
7.27.23 MOTOR.R	572
7.27.24 MOTOR.SUPPORTEDPARAMS	573
7.27.25 MOTOR.TBRAKEAPP	574
7.27.26 MOTOR.TBRAKERLS	575
7.27.27 MOTOR.TBRAKETO	576
7.27.28 MOTOR.TEMP	577
7.27.29 MOTOR.TEMPC	578
7.27.30 MOTOR.TEMPFALT	579
7.27.31 MOTOR.TEMPWARN	580
7.27.32 MOTOR.TYPE	581
7.27.33 MOTOR.VMAX	583
7.27.34 MOTOR.VOLTMAX	584
7.27.35 MOTOR.VOLTMIN	585

7.27.36 MOTOR.VOLTRATED	586
7.27.37 MOTOR.VRATED	587

7.27.1 MOTOR.AUTOSSET

General Information	
Type	NV Parameter
Description	Determines which drive parameters are calculated automatically.
Units	N/A
Range	0 to 1
Default Value	0
Data Type	Boolean
See Also	N/A
Start Version	M_01-00-00-000

Variants Supported

Variant	Supported
AKD Base	Yes
AKD with Position Indexer	Yes
AKD EtherCAT	Yes
AKD CANopen	Yes
AKD BASIC	Yes
AKD SynqNet	Yes
AKD EtherNet/IP	Yes
AKD Profinet	Yes
AKD sercos [®] III	Yes
AKD-N	Yes
AKD-C	No

Fieldbus Information

Fieldbus	Index/Subindex	Object Start Version
EtherCAT COE and CANopen CANopen	3451h/0	M_01-00-00-000

Fieldbus	Address	Attributes	Signed?
Profinet	2240	Byte	No
sercos [®] III		2 Octets	

Fieldbus	Index/Subindex	Is 64 bit?	Attributes	Signed?	Object Start Version
Modbus	480	No	8 bit	No	M_01-03-00-000

Description

This parameter determines whether or not certain drive parameters (see lists below) are calculated automatically. When MOTOR.AUTOSSET = 1 these parameters are automatically calculated from the motor ID data (read from memory-supporting feedback devices). Parameters loaded from motor memory are then read-only and cannot be modified as long as MOTOR.AUTOSSET = 1. If MOTOR.AUTOSSET = 0, parameters are not loaded from motor memory and must be configured by the user. Parameters which are not loaded from motor memory are always read-write.

Three conditions determine which parameters are calculated automatically by MOTOR.AUTOSSET = 1. See the lists below to determine which parameters will automatically be configured from the motor ID data.

The following parameters may be configured automatically when MOTOR.AUTOSSET = 1:

- MOTOR.BRAKE (pg 550)
- MOTOR.CTF0 (pg 555)
- MOTOR.ICONT (pg 556)
- MOTOR.INERTIA (pg 559)
- MOTOR.IPEAK (pg 560)
- MOTOR.KE (pg 561)
- MOTOR.KT (pg 562)
- MOTOR.LQLL (pg 565)
- MOTOR.NAME (pg 566)
- MOTOR.POLES (pg 571)
- MOTOR.R (pg 572)

If the motor's FB1.MEMVER > 0.01, AKD will also configure:

- MOTOR.PHASE (pg 567)
- MOTOR.TBRAKEAPP (pg 574)
- MOTOR.PHASE (pg 567)
- MOTOR.VRATED (pg 587)
- MOTOR.VOLTRATED (pg 586)

For firmware versions 01-09-00-000 and later, AKD will also configure:

- MOTOR.RTYPE
- MOTOR.TEMPFAULT (pg 579)

7.27.2 MOTOR.BRAKE

General Information	
Type	NV Parameter
Description	Sets the presence or absence of a motor brake.
Units	N/A
Range	0 to 1
Default Value	0
Data Type	Boolean
See Also	N/A
Start Version	M_01-00-00-000

AKD BASIC Information	
Data Type	Integer

Variants Supported

Variant	Supported
AKD Base	Yes
AKD with Position Indexer	Yes
AKD EtherCAT	Yes
AKD CANopen	Yes
AKD BASIC	Yes
AKD SynqNet	Yes
AKD EtherNet/IP	Yes
AKD Profinet	Yes
AKD sercos [®] III	Yes
AKD-N	Yes
AKD-C	No

Fieldbus Information

Fieldbus	Index/Subindex	Object Start Version
EtherCAT COE and CANopen CANopen	3587h/0	M_01-00-00-000

Fieldbus	Address	Attributes	Signed?
Profinet	2241	Byte	No
sercos [®] III		2 Octets	

Fieldbus	Index/Subindex	Is 64 bit?	Attributes	Signed?	Object Start Version
Modbus	482	No	8 bit	No	M_01-03-00-000

Description

The MOTOR.BRAKE parameter notifies the firmware whether a brake exists or not. It does not apply or release the brake. If a brake is found to be present, the firmware considers hardware indications regarding the brake circuits (such as open circuit or short circuit). If a brake does not exist, then the firmware ignores the hardware indications since they are irrelevant.

Value	Status
0	Motor brake does not exist.
1	Motor brake exists and brake hardware circuitry checks are enabled.

Enabling the MOTOR.BRAKE (value set to 1) when no motor brake exists creates a fault. The motor brake is polled every 16 ms.

NOTE

This parameter is automatically configured for Kollmorgen motors when MOTOR.AUTOSSET=1.

7.27.3 MOTOR.BRAKEIMM

General Information	
Type	NV Parameter
Description	Brake Immediately: in the case of a drive disable, apply the brake in all situations.
Units	N/A
Range	0 to 1
Default Value	0 (Inactive)
Data Type	Boolean
See Also	N/A
Start Version	M_01-05-11-000

Variants Supported

Variant	Supported
AKD Base	Yes
AKD with Position Indexer	Yes
AKD EtherCAT	Yes
AKD CANopen	Yes
AKD BASIC	Yes
AKD SynqNet	Yes
AKD EtherNet/IP	Yes
AKD Profinet	Yes
AKD sercos [®] III	Yes
AKD-N	Yes
AKD-C	No

Fieldbus Information

Fieldbus	Address	Attributes	Signed?
Profinet	2616	Byte	No
sercos [®] III		2 Octets	

Fieldbus	Index/Subindex	Is 64 bit?	Attributes	Signed?
Modbus	1232	No	8 bit	No

Description

With the standard configuration, when the drive disables, the brake will not apply until velocity falls below CS.VTHRESH for CS.TO milliseconds. However, in some machines (such as a vertical axis) the brake should be applied immediately whenever the drive disables.

To ensure that the brake is applied immediately after any disable (due to fault, disable command, etc), set MOTOR.BRAKEIMM = 1.

7.27.4 MOTOR.BRAKERLS

General Information	
Type	Command
Description	Allows a user to release or apply the motor brake.
Units	N/A
Range	0 to 2
Default Value	0
Data Type	Integer
See Also	N/A
Start Version	M_01-00-00-000

Variants Supported

Variant	Supported
AKD Base	Yes
AKD with Position Indexer	Yes
AKD EtherCAT	Yes
AKD CANopen	Yes
AKD BASIC	Yes
AKD SynqNet	Yes
AKD EtherNet/IP	Yes
AKD Profinet	Yes
AKD sercos [®] III	Yes
AKD-N	Yes
AKD-C	No

Fieldbus Information

Fieldbus	Index/Subindex	Is 64 bit?	Attributes	Signed?	Object Start Version
Modbus	484	No	8 bit	No	M_01-03-00-000

Description

This command allows a user to release or apply the motor brake.

0 = Drive controls the brake.

1 = Brake is released.

2 = Brake is applied.

NOTE

A digital input mode is also used for the same purpose. The two mechanisms are independent.

NOTE

The CANopen-object 0x345A sub 1/2 can be used to control the brake state. See [CANopen manual](#) on kollmorgen.com. (Functionality starts with firmware 1.7.4.0)

7.27.5 MOTOR.BRAKESTATE

General Information	
Type	R/O Parameter
Description	Reads the actual status of the motor brake.
Units	N/A
Range	Brake released or not present. Brake applied.
Default Value	Brake applied or not present.
Data Type	String
See Also	N/A
Start Version	M_01-00-00-000

Variants Supported

Variant	Supported
AKD Base	Yes
AKD with Position Indexer	Yes
AKD EtherCAT	Yes
AKD CANopen	Yes
AKD BASIC	Yes
AKD SynqNet	Yes
AKD EtherNet/IP	Yes
AKD Profinet	Yes
AKD sercos [®] III	Yes
AKD-N	Yes
AKD-C	No

Description

This parameter reads the actual status of the motor brake and can only show two states:

1 = Brake released or not present

2 = Brake applied

7.27.6 MOTOR.CTF0

General Information	
Type	NV Parameter
Description	Sets the thermal constant of the motor coil.
Units	mHz
Range	0.265 to 16,000 mHz
Default Value	10 mHz
Data Type	Float
See Also	N/A
Start Version	M_01-00-00-000

Variants Supported

Variant	Supported
AKD Base	Yes
AKD with Position Indexer	Yes
AKD EtherCAT	Yes
AKD CANopen	Yes
AKD BASIC	Yes
AKD SynqNet	Yes
AKD EtherNet/IP	Yes
AKD Profinet	Yes
AKD sercos [®] III	Yes
AKD-N	Yes
AKD-C	No

Fieldbus Information

Fieldbus	Index/Subindex	Is 64 bit?	Attributes	Signed?	Object Start Version
Modbus	486	No	32 bit	No	M_01-03-00-000

Description

This parameter is used to configure the thermal constant of the motor coil, which is the break frequency of a single-pole low-pass filter model of the thermal dynamics of the motor coil.

This parameter, together with MOTOR.IPEAK (pg 560) and MOTOR.ICONT (pg 556), determine the motor foldback parameters IL.MFOLDD (pg 510), IL.MFOLDT (pg 512), and IL.MFOLDR (pg 511).

Calculating MOTOR.CTF0

Given a motor coil/winding thermal time constant T in seconds, then:

$$\text{MOTOR.CTF0} = 1 / (2\pi T)$$

NOTE

This parameter is automatically configured for Kollmorgen motors when MOTOR.AUTOSSET=1.

7.27.7 MOTOR.ICONT

General Information	
Type	NV Parameter
Description	Sets the motor continuous current.
Units	A
Range	0.1 to 500 A
Default Value	1.0 A
Data Type	Float
See Also	N/A
Start Version	M_01-00-00-000

AKD BASIC Information	
Type	R/W

Variants Supported

Variant	Supported
AKD Base	Yes
AKD with Position Indexer	Yes
AKD EtherCAT	Yes
AKD CANopen	Yes
AKD BASIC	Yes
AKD SynqNet	Yes
AKD EtherNet/IP	Yes
AKD Profinet	Yes
AKD sercos [®] III	Yes
AKD-N	Yes
AKD-C	No

Fieldbus Information

Fieldbus	Index/Subindex	Object Start Version
EtherCAT COE and CANopen CANopen	358Eh/0	M_01-00-00-000

Fieldbus	Address	Attributes	Signed?
Profinet	2244	DWord	No
sercos [®] III		4 Octets	

Fieldbus	Index/Subindex	Is 64 bit?	Attributes	Signed?	Object Start Version
Modbus	488	No	32 bit	No	M_01-03-00-000

Description

This parameter is used to configure the motor continuous current.

NOTE

This parameter is automatically configured for Kollmorgen motors when MOTOR.AUTOSSET=1.

7.27.8 MOTOR.IDDATAVALID

General Information	
Type	R/O Parameter
Description	Reports the status of the motor memory.
Units	N/A
Range	N/A
Default Value	0
Data Type	Integer
See Also	N/A
Start Version	M_01-02-00-000

Variants Supported

Variant	Supported
AKD Base	Yes
AKD with Position Indexer	Yes
AKD EtherCAT	Yes
AKD CANopen	Yes
AKD BASIC	Yes
AKD SynqNet	Yes
AKD EtherNet/IP	Yes
AKD Profinet	Yes
AKD sercos [®] III	Yes
AKD-N	Yes
AKD-C	No

Fieldbus Information

Fieldbus	Address	Attributes	Signed?
Profinet	2245	Byte	No
sercos [®] III		2 Octets	

Fieldbus	Index/Subindex	Is 64 bit?	Attributes	Signed?	Object Start Version
Modbus	490	No	8 bit	No	M_01-03-00-000

Description

MOTOR.IDDATAVALID reports the status of the motor memory status.

The valid values for this keyword are the following:

Value	Description
0	Error in identification
1	Success in identification
2	Identification in process
3	Identification not started yet
4	Success recognizing feedback, but failed to verify OEM data integrity

7.27.9 MOTOR.IDMAX

General Information	
Type	NV Parameter
Description	Maximum direct axis current.
Units	Arms
Range	0.2 to 1000
Default Value	0.5 * MOTOR.IPEAK
Data Type	Float
Start Version	M_01-11-00-000

Variants Supported

Variant	Supported
AKD Base	Yes
AKD with Position Indexer	Yes
AKD EtherCAT	Yes
AKD CANopen	Yes
AKD BASIC	Yes
AKD SynqNet	Yes
AKD EtherNet/IP	Yes
AKD Profinet	Yes
AKD sercos [®] III	Yes
AKD-N	Yes
AKD-C	No

Description

This parameter is supported for IPM motors (MOTOR.TYPE = 6). MOTOR.IDMAX is the maximum motor winding current in the direct (non-torque producing) axis.

NOTE

This parameter is automatically configured for Kollmorgen motors when MOTOR.AUTOSSET = 1.

7.27.10 MOTOR.INERTIA

General Information	
Type	NV Parameter
Description	Sets the motor inertia.
Units	kgcm ² for rotary motors kg for linear motors
Range	1 to 200,000 kgcm ² or kg
Default Value	100 kgcm ² or kg
Data Type	Float
See Also	N/A
Start Version	M_01-00-00-000

Variants Supported

Variant	Supported
AKD Base	Yes
AKD with Position Indexer	Yes
AKD EtherCAT	Yes
AKD CANopen	Yes
AKD BASIC	Yes
AKD SynqNet	Yes
AKD EtherNet/IP	Yes
AKD Profinet	Yes
AKD sercos [®] III	Yes
AKD-N	Yes
AKD-C	No

Fieldbus Information

Fieldbus	Index/Subindex	Object Start Version
EtherCAT COE and CANopen CANopen	35ABh/0	M_01-00-00-000

Fieldbus	Address	Attributes	Signed?
Profinet	2246	DWord	No
sercos [®] III		4 Octets	

Fieldbus	Index/Subindex	Is 64 bit?	Attributes	Signed?	Object Start Version
Modbus	492	No	32 bit	No	M_01-03-00-000

Description

This parameter sets the motor inertia.

NOTE

This parameter is automatically configured for Kollmorgen motors when MOTOR.AUTOSSET=1.

7.27.11 MOTOR.IPEAK

General Information	
Type	NV Parameter
Description	Sets the motor peak current.
Units	mA
Range	0.200 to 1,000 A
Default Value	2.000 A
Data Type	Float
See Also	IL.LIMITP (pg 509), IL.LIMITN (pg 508)
Start Version	M_01-00-00-000

Variants Supported

Variant	Supported
AKD Base	Yes
AKD with Position Indexer	Yes
AKD EtherCAT	Yes
AKD CANopen	Yes
AKD BASIC	Yes
AKD SynqNet	Yes
AKD EtherNet/IP	Yes
AKD Profinet	Yes
AKD sercos [®] III	Yes
AKD-N	Yes
AKD-C	No

Fieldbus Information

Fieldbus	Index/Subindex	Object Start Version
EtherCAT COE and CANopen CANopen	358Fh/0	M_01-00-00-000

Fieldbus	Address	Attributes	Signed?
Profinet	2247	DWord	No
sercos [®] III		4 Octets	

Fieldbus	Index/Subindex	Is 64 bit?	Attributes	Signed?	Object Start Version
Modbus	494	No	32 bit	No	M_01-03-00-000

Description

This parameter configures the drive for the motor's peak, instantaneous-rated current. MOTOR.IPEAK is used to limit clamp the magnitude of the torque producing q-component current command (IL.CMD (pg 486)).

NOTE

This parameter is automatically configured for Kollmorgen motors when MOTOR.AUTOSSET=1.

7.27.12 MOTOR.KE

General Information	
Type	NV Parameter
Description	Sets the motor back EMF constant.
Units	Vpeak/krpm for Rotary Motors Vpeak/m/s for Linear Motors
Range	0.0 to 100,000
Default Value	0
Data Type	Float
See Also	N/A
Start Version	M_01-03-06-000

Variants Supported

Variant	Supported
AKD Base	Yes
AKD with Position Indexer	Yes
AKD EtherCAT	Yes
AKD CANopen	Yes
AKD BASIC	Yes
AKD SynqNet	Yes
AKD EtherNet/IP	Yes
AKD Profinet	Yes
AKD sercos [®] III	Yes
AKD-N	Yes
AKD-C	No

Fieldbus Information

Fieldbus	Index/Subindex	Is 64 bit?	Attributes	Signed?
Modbus	1216	No	32 bit	No

Description

MOTOR.KE defines the back EMF constant for the motor. The back EMF constant defines how much voltage is generated at the motors coils. The relationship between MOTOR.KE and speed is described by the following equation:

$$\text{Coil Voltage} = \text{MOTOR.KE} * \text{VL.FB}$$

VL.FB is in units of krpm for rotary motors and in units of m/s for linear motors.

The maximum speed for interior permanent magnet motors (IPM) is determined by MOTOR.KE and VBUS.VALUE. An overspeed fault is generated if MOTOR.TYPE is set to 6 (IPM) and VL.FB * MOTOR.KE exceeds VBUS.VALUE.

NOTE

This parameter is automatically configured for Kollmorgen motors when MOTOR.AUTOSSET=1.

7.27.13 MOTOR.KT

General Information	
Type	NV Parameter
Description	Sets the torque constant of the motor.
Units	Nm/A
Range	0.001 Nm/A to 1,000,000.000 Nm/A for rotary motors. 0.001 Nm/A to 1,000,000.000 N/A for linear motors.
Default Value	0.1 Nm/A
Data Type	Float
See Also	N/A
Start Version	M_01-00-00-000

Variants Supported

Variant	Supported
AKD Base	Yes
AKD with Position Indexer	Yes
AKD EtherCAT	Yes
AKD CANopen	Yes
AKD BASIC	Yes
AKD SynqNet	Yes
AKD EtherNet/IP	Yes
AKD Profinet	Yes
AKD sercos [®] III	Yes
AKD-N	Yes
AKD-C	No

Fieldbus Information

Fieldbus	Index/Subindex	Is 64 bit?	Attributes	Signed?	Object Start Version
Modbus	496	No	32 bit	No	M_01-03-00-000

Description

This parameter is the torque constant of the motor in Nm/A. The value can be online checked according to the following equation:

$$K_t = 60 \cdot \sqrt{3} \cdot U_i / (2 \cdot \pi \cdot n)$$

Where:

U_i = induced voltage of the motor

n = actual rotor velocity

NOTE

This parameter is automatically configured for Kollmorgen motors when MOTOR.AUTOSSET=1.

7.27.14 MOTOR.LDLL

General Information	
Type	NV Parameter
Description	Motor line to line direct axis inductance.
Units	mH
Range	1 to 2 ³¹
Default Value	17.000
Data Type	Float
Start Version	M_01-11-00-000

Variants Supported

Variant	Supported
AKD Base	Yes
AKD with Position Indexer	Yes
AKD EtherCAT	Yes
AKD CANopen	Yes
AKD BASIC	Yes
AKD SynqNet	Yes
AKD EtherNet/IP	Yes
AKD Profinet	Yes
AKD sercos [®] III	Yes
AKD-N	Yes
AKD-C	No

Descriptio

This parameter is the motor line to line direct axis inductance. It is supported for the IPM motor type (MOTOR.TYPE = 6).

NOTE

This parameter is automatically configured for Kollmorgen motors when MOTOR.AUTOSET = 1.

7.27.15 MOTOR.LISAT

General Information	
Type	NV Parameter
Description	Motor quadrature axis inductance saturation characteristic.
Units	Arms
Range	0.2A to 2*DRV.IPEAK
Default Value	1000
Data Type	Float
Start Version	M_01-11-00-000

Variants Supported

Variant	Supported
AKD Base	Yes
AKD with Position Indexer	Yes
AKD EtherCAT	Yes
AKD CANopen	Yes
AKD BASIC	Yes
AKD SynqNet	Yes
AKD EtherNet/IP	Yes
AKD Profinet	Yes
AKD sercos [®] III	Yes
AKD-N	Yes
AKD-C	No

Descriptio

This parameter is the quadrature axis inductance (L_{qII}) saturation characteristic as a function of quadrature current (I_q). It is used for q-axis current loop gain scheduling to maintain bandwidth and stability during q-axis inductance saturation. This value can also be used for q-axis flux estimation during field weakening, especially for IPM motors (MOTOR.TYPE = 6).

NOTE

This parameter is automatically configured for Kollmorgen motors when MOTOR.AUTOSET = 1.

7.27.16 MOTOR.LQLL

General Information	
Type	NV Parameter
Description	Sets the line-to-line motor Lq.
Units	mH
Range	1 to 2 ³² H
Default Value	17.000 H
Data Type	Float
See Also	N/A
Start Version	M_01-00-00-000

Variants Supported

Variant	Supported
AKD Base	Yes
AKD with Position Indexer	Yes
AKD EtherCAT	Yes
AKD CANopen	Yes
AKD BASIC	Yes
AKD SynqNet	Yes
AKD EtherNet/IP	Yes
AKD Profinet	Yes
AKD sercos [®] III	Yes
AKD-N	Yes
AKD-C	No

Fieldbus Information

Fieldbus	Index/Subindex	Object Start Version
EtherCAT COE and CANopen CANopen	3455h/0	M_01-00-00-000

Fieldbus	Address	Attributes	Signed?
Profinet	2249	DWord	No
sercos [®] III		4 Octets	

Fieldbus	Index/Subindex	Is 64 bit?	Attributes	Signed?	Object Start Version
Modbus	498	No	32 bit	No	M_01-03-00-000

Description

This parameter is used to configure the motor line-to-line inductance.

NOTE

This parameter is automatically configured for Kollmorgen motors when MOTOR.AUTOSSET=1.

7.27.17 MOTOR.NAME

General Information	
Type	NV Parameter
Description	Sets the motor name.
Units	N/A
Range	11 chars
Default Value	N/A
Data Type	String
See Also	N/A
Start Version	M_01-00-00-000

Variants Supported

Variant	Supported
AKD Base	Yes
AKD with Position Indexer	Yes
AKD EtherCAT	Yes
AKD CANopen	Yes
AKD BASIC	Yes
AKD SynqNet	Yes
AKD EtherNet/IP	Yes
AKD Profinet	Yes
AKD sercos [®] III	Yes
AKD-N	Yes
AKD-C	No

Description

This parameter is used to set the motor name.

NOTE

This parameter is automatically configured for Kollmorgen motors when MOTOR.AUTOSSET=1.

7.27.18 MOTOR.PHASE

General Information	
Type	NV Parameter
Description	Sets the motor phase.
Units	Electrical degrees
Range	0 to 360°
Default Value	0°
Data Type	Integer
See Also	N/A
Start Version	M_01-00-00-000

Variants Supported

Variant	Supported
AKD Base	Yes
AKD with Position Indexer	Yes
AKD EtherCAT	Yes
AKD CANopen	Yes
AKD BASIC	Yes
AKD SynqNet	Yes
AKD EtherNet/IP	Yes
AKD Profinet	Yes
AKD sercos [®] III	Yes
AKD-N	Yes
AKD-C	No

Fieldbus Information

Fieldbus	Index/Subindex	Object Start Version
EtherCAT COE and CANopen CANopen	359Ch/0	M_01-00-00-000

Fieldbus	Address	Attributes	Signed?
Profinet	2250	Word	No
sercos [®] III		2 Octets	

Fieldbus	Index/Subindex	Is 64 bit?	Attributes	Signed?	Object Start Version
Modbus	500	No	16 bit	No	M_01-03-00-000

Description

This parameter sets the motor phase.

NOTE

If MOTOR.AUTOSSET = 1 and FB1.MEMVER > 0.01, this parameter will be automatically configured for Kollmorgen motors.

7.27.19 MOTOR.PHSADV1

General Information	
Type	NV Parameter
Description	First order phase advance polynomial coefficient.
Units	N/A
Range	-1.0 to 1.0
Default Value	0
Data Type	Float
Start Version	M_01-11-00-000

Variants Supported

Variant	Supported
AKD Base	Yes
AKD with Position Indexer	Yes
AKD EtherCAT	Yes
AKD CANopen	Yes
AKD BASIC	Yes
AKD SynqNet	Yes
AKD EtherNet/IP	Yes
AKD Profinet	Yes
AKD sercos [®] III	Yes
AKD-N	Yes
AKD-C	No

Description

This parameter is supported for IPM motors (MOTOR.TYPE = 6). MOTOR.PHSADV1 is the first order polynomial coefficient used to determine the direct axis current command for commutation phase advance, according to the equation:

$$IdCmd(I_p) = PHSADV2 * I_p^2 + PHSADV1 * I_p$$

where I_p is the magnitude of the motor phase current:

$$I_p = \sqrt{Id^2 + Iq^2}$$

NOTE

This parameter is automatically configured for Kollmorgen motors when MOTOR.AUTOSSET=1.

7.27.20 MOTOR.PHSADV2

General Information	
Type	NV Parameter
Description	Second order phase advance polynomial coefficient.
Units	N/A
Range	-1.0 to 1.0
Default Value	0
Data Type	Float
Start Version	M_01-11-00-000

Variants Supported

Variant	Supported
AKD Base	Yes
AKD with Position Indexer	Yes
AKD EtherCAT	Yes
AKD CANopen	Yes
AKD BASIC	Yes
AKD SynqNet	Yes
AKD EtherNet/IP	Yes
AKD Profinet	Yes
AKD sercos [®] III	Yes
AKD-N	Yes
AKD-C	No

Description

This parameter is supported for IPM motors (MOTOR.TYPE = 6). MOTOR.PHSADV2 is the second order polynomial coefficient used to determine the direct axis current command for commutation phase advance, according to the equation:

$$IdCmd(I_p) = PHSADV2 * I_p^2 + PHSADV1 * I_p$$

where I_p is the magnitude of the motor phase current:

$$I_p = \sqrt{Id^2 + Iq^2}$$

NOTE

This parameter is automatically configured for Kollmorgen motors when MOTOR.AUTOSSET=1.

7.27.21 MOTOR.PITCH

General Information	
Type	NV Parameter
Description	Sets the motor pitch.
Units	µm
Range	1,000 to 1,000,000 µm
Default Value	1.000 µm
Data Type	Integer
See Also	N/A
Start Version	M_01-00-00-000

Variants Supported

Variant	Supported
AKD Base	Yes
AKD with Position Indexer	Yes
AKD EtherCAT	Yes
AKD CANopen	Yes
AKD BASIC	Yes
AKD SynqNet	Yes
AKD EtherNet/IP	Yes
AKD Profinet	Yes
AKD sercos [®] III	Yes
AKD-N	Yes
AKD-C	No

Fieldbus Information

Fieldbus	Address	Attributes	Signed?
Profinet	2251	DWord	No
sercos [®] III		4 Octets	

Fieldbus	Index/Subindex	Is 64 bit?	Attributes	Signed?	Object Start Version
Modbus	502	No	32 bit	No	M_01-03-00-000

Description

This parameter defines the pole-to-pair pitch for the linear motor in micrometers.

7.27.22 MOTOR.POLES

General Information	
Type	NV Parameter
Description	Sets the number of motor poles.
Units	N/A
Range	0 to 128
Default Value	6
Data Type	Integer
See Also	FB1.POLES (pg 435)
Start Version	M_01-00-00-000

Variants Supported

Variant	Supported
AKD Base	Yes
AKD with Position Indexer	Yes
AKD EtherCAT	Yes
AKD CANopen	Yes
AKD BASIC	Yes
AKD SynqNet	Yes
AKD EtherNet/IP	Yes
AKD Profinet	Yes
AKD sercos [®] III	Yes
AKD-N	Yes
AKD-C	No

Fieldbus Information

Fieldbus	Index/Subindex	Object Start Version
EtherCAT COE and CANopen CANopen	359Dh/0	M_01-00-00-000

Fieldbus	Address	Attributes	Signed?
Profinet	2252	Word	No
sercos [®] III		2 Octets	

Fieldbus	Index/Subindex	Is 64 bit?	Attributes	Signed?	Object Start Version
Modbus	504	No	16 bit	No	M_01-03-00-000

Description

MOTOR.POLES sets the number of motor poles. This command is used for commutation control and represents the number of individual magnetic poles of the motor (not pole pairs). The division value of motor poles (MOTOR.POLES) and feedback poles (FB1.POLES) must be an integer when setting drive to enable, otherwise a fault is issued.

NOTE

This parameter is automatically configured for Kollmorgen motors when MOTOR.AUTOSSET=1.

7.27.23 MOTOR.R

General Information	
Type	NV Parameter
Description	Sets the stator winding resistance phase-phase in ohms.
Units	Ω
Range	0.001 to 650 Ω
Default Value	10 Ω
Data Type	Float
See Also	N/A
Start Version	M_01-00-00-000

Variants Supported

Variant	Supported
AKD Base	Yes
AKD with Position Indexer	Yes
AKD EtherCAT	Yes
AKD CANopen	Yes
AKD BASIC	Yes
AKD SynqNet	Yes
AKD EtherNet/IP	Yes
AKD Profinet	Yes
AKD sercos [®] III	Yes
AKD-N	Yes
AKD-C	No

Fieldbus Information

Fieldbus	Index/Subindex	Object Start Version
EtherCAT COE and CANopen CANopen	3456h/0	M_01-00-00-000

Fieldbus	Address	Attributes	Signed?
Profinet	2253	DWord	No
sercos [®] III		4 Octets	

Fieldbus	Index/Subindex	Is 64 bit?	Attributes	Signed?	Object Start Version
Modbus	506	No	32 bit	No	M_01-03-00-000

Description

MOTOR.R sets the stator winding resistance phase-to-phase in ohms.

NOTE

This parameter is automatically configured for Kollmorgen motors when MOTOR.AUTOSSET=1.

7.27.24 MOTOR.SUPPORTEDPARAMS

General Information	
Type	R/O Parameter
Description	Lists MOTOR parameters supported by configured motor type.
Units	N/A
Range	N/A
Default Value	N/A
Data Type	String
Start Version	M_01-11-00-000

Variants Supported

Variant	Supported
AKD Base	Yes
AKD with Position Indexer	Yes
AKD EtherCAT	Yes
AKD CANopen	Yes
AKD BASIC	Yes
AKD SynqNet	Yes
AKD EtherNet/IP	Yes
AKD Profinet	Yes
AKD sercos [®] III	Yes
AKD-N	Yes
AKD-C	No

Descriptio

This parameter lists all the MOTOR parameters that are supported for the motor type selected by the MOTOR.TYPE parameter.

Example

The following output is produced for surface permanent magnet motors (MOTOR.TYPE = 0).

→ MOTOR.SUPPORTEDPARAMS

```
MOTOR.CTF0
MOTOR.ICONT
MOTOR.INERTIA
MOTOR.IPEAK
MOTOR.KE
MOTOR.KT
MOTOR.LISAT
MOTOR.LQLL
MOTOR.PHASE
MOTOR.POLES
MOTOR.R
MOTOR.VMAX
MOTOR.VOLTMAX
```

7.27.25 MOTOR.TBRAKEAPP

General Information	
Type	NV Parameter
Description	The delay time used for applying the motor brake.
Units	ms
Range	0 to 1,000 ms
Default Value	75 ms
Data Type	Integer
See Also	N/A
Start Version	M_01-00-00-000

Variants Supported

Variant	Supported
AKD Base	Yes
AKD with Position Indexer	Yes
AKD EtherCAT	Yes
AKD CANopen	Yes
AKD BASIC	Yes
AKD SynqNet	Yes
AKD EtherNet/IP	Yes
AKD Profinet	Yes
AKD sercos [®] III	Yes
AKD-N	Yes
AKD-C	No

Fieldbus Information

Fieldbus	Index/Subindex	Is 64 bit?	Attributes	Signed?	Object Start Version
Modbus	510	No	16 bit	No	M_01-03-00-000

Description

This parameter is used to configure the mechanical delay when applying the motor brake.

MOTOR.TBRAKEAPP is a time delay that is applied when a brake exists and the drive is disabled at the end of a controlled stop. This delay lasts from the time that the brake is commanded to apply until the time that the drive is disabled.

This feature allows you to disable the drive and apply the brake on a vertical application without the load falling. Without this time delay, if you immediately disable the drive, then the load falls during the time needed for the brake to mechanically apply.

NOTE

If MOTOR.AUTOSSET = 1 and FB1.MEMVER > 0.01, this parameter will be automatically configured for Kollmorgen motors.

7.27.26 MOTOR.TBRAKERLS

General Information	
Type	NV Parameter
Description	The delay time used for releasing the motor brake.
Units	ms
Range	0 to 1,000 ms
Default Value	75 ms
Data Type	Integer
See Also	N/A
Start Version	M_01-00-00-000

Variants Supported

Variant	Supported
AKD Base	Yes
AKD with Position Indexer	Yes
AKD EtherCAT	Yes
AKD CANopen	Yes
AKD BASIC	Yes
AKD SynqNet	Yes
AKD EtherNet/IP	Yes
AKD Profinet	Yes
AKD sercos [®] III	Yes
AKD-N	Yes
AKD-C	No

Fieldbus Information

Fieldbus	Index/Subindex	Is 64 bit?	Attributes	Signed?	Object Start Version
Modbus	512	No	16 bit	No	M_01-03-00-000

Description

This parameter is used to configure the mechanical delay when releasing the motor brake. MOTOR.TBRAKERLS is a time delay that is applied when a brake exists and the drive is enabled. When the drive is enabled, the brake is commanded to release and, during the MOTOR.TBRAKERLS period of time, the drive does not accept a motion command. This delay allows the brake to fully release before the drive begins a new motion.

NOTE

If MOTOR.AUTOSET = 1 and FB1.MEMVER > 0.01, this parameter will be automatically configured for Kollmorgen motors.

7.27.27 MOTOR.TBRAKETO

General Information	
Type	NV Parameter
Description	Brake apply timeout for vertical axis.
Units	Milliseconds
Range	-1 to 30,000
Default Value	-1 (function disabled)
Data Type	Integer
See Also	CS.VTHRESH (pg 258), CS.TO (pg 256), DRV.DISTO (pg 325)
Start Version	01-05-07-000

Variants Supported

Variant	Supported
AKD Base	Yes
AKD with Position Indexer	Yes
AKD EtherCAT	Yes
AKD CANopen	Yes
AKD BASIC	Yes
AKD SynqNet	Yes
AKD EtherNet/IP	Yes
AKD Profinet	Yes
AKD sercos [®] III	Yes
AKD-N	Yes
AKD-C	No

Fieldbus Information

Fieldbus	Address	Attributes	Signed?
Profinet	2495	DWord	Yes
sercos [®] III		4 Octets	

Fieldbus	Index/Subindex	Is 64 bit?	Attributes	Signed?
Modbus	990	No	32 bit	Yes

Description

When a drive is disabled (due to user command, digital input, or fault), the brake will normally not be applied until velocity has fallen below CS.VTHRESH (pg 258). In some instances, such as a vertical axis, it may be desirable to apply the brake regardless of velocity.

MOTOR.TBRAKETO sets the maximum time allowed to pass between drive disable and application of the motor brake. After this time, the brake will be applied even if velocity is higher than CS.VTHRESH (pg 258).

To disable the timer, set the value to -1.

NOTE

Prior to version 01-05-07-000, this timeout was only applied when the Hardware Enable was deactivated and the default was 30,000. From 01-05-07-000 on this timeout is applied in all conditions and the default is -1.

7.27.28 MOTOR.TEMP

General Information	
Type	R/O Parameter
Description	Reads the motor temperature represented as the resistance of the motor PTC or NTC.
Units	Ω
Range	0 to $2^{32} \Omega$
Default Value	N/A
Data Type	Integer
See Also	N/A
Start Version	M_01-00-00-000

Variants Supported

Variant	Supported
AKD Base	Yes
AKD with Position Indexer	Yes
AKD EtherCAT	Yes
AKD CANopen	Yes
AKD BASIC	Yes
AKD SynqNet	Yes
AKD EtherNet/IP	Yes
AKD Profinet	Yes
AKD sercos [®] III	Yes
AKD-N	Yes
AKD-C	No

Fieldbus Information

Fieldbus	Index/Subindex	Object Start Version
EtherCAT COE and CANopen CANopen	3612h/0	M_01-00-00-000

Fieldbus	Address	Attributes	Signed?
Profinet	2257	DWord	No
sercos [®] III		4 Octets	

Fieldbus	Index/Subindex	Is 64 bit?	Attributes	Signed?	Object Start Version
Modbus	514	No	32 bit	No	M_01-03-00-000

Description

This parameter returns the motor temperature, which is represented as the resistance of the motor's PTC or NTC.

7.27.29 MOTOR.TEMPC

General Information	
Type	R/O Parameter
Description	Reads the motor temperature in degrees Celsius.
Units	Degrees Celsius
Range	-2^{15} to 2^{15}
Default Value	N/A
Data Type	Integer
Start Version	M_01-10-04-000

Variants Supported

Variant	Supported
AKD Base	Yes
AKD with Position Indexer	Yes
AKD EtherCAT	Yes
AKD CANopen	Yes
AKD BASIC	Yes
AKD SynqNet	Yes
AKD EtherNet/IP	Yes
AKD Profinet	Yes
AKD sercos [®] III	Yes
AKD-N	Yes
AKD-C	No

Description

When the motor has a thermistor with linear characteristics (MOTOR.RTYPE = 2, 3 or 4), MOTOR.TEMPC returns the motor temperature in degrees Celsius, which is calculated from the resistance of the motor thermistor.

There is no algorithm to convert from resistance to degrees Celsius for non-linear thermistors. In this case, MOTOR.TEMPC returns -32,768 which is an invalid temperature.

7.27.30 MOTOR.TEMPFAULT

General Information	
Type	NV Parameter
Description	Sets the motor temperature fault level.
Units	Ω
Range	0 to 2,000,000,000 Ω
Default Value	0 Ω = switched off
Data Type	Integer
See Also	MOTOR.TEMP (pg 577)
Start Version	M_01-00-00-000

Variants Supported

Variant	Supported
AKD Base	Yes
AKD with Position Indexer	Yes
AKD EtherCAT	Yes
AKD CANopen	Yes
AKD BASIC	Yes
AKD SynqNet	Yes
AKD EtherNet/IP	Yes
AKD Profinet	Yes
AKD sercos [®] III	Yes
AKD-N	Yes
AKD-C	No

Fieldbus Information

Fieldbus	Index/Subindex	Object Start Version
EtherCAT COE and CANopen CANopen	3586h/0	M_01-00-00-000

Fieldbus	Address	Attributes	Signed?
Profinet	2258	DWord	No
sercos [®] III		4 Octets	

Fieldbus	Index/Subindex	Is 64 bit?	Attributes	Signed?	Object Start Version
Modbus	516	No	32 bit	No	M_01-03-00-000

Description

This parameter is used to configure the motor temperature fault level as a resistance threshold of the motor thermal sensor.

A zero value prevents any fault from being issued.

NOTE

For firmware versions 01-09-00-000 and later, this parameter is automatically configured for Kollmorgen motors when MOTOR.AUTOSSET = 1.

7.27.31 MOTOR.TEMPWARN

General Information	
Type	NV Parameter
Description	Sets the motor temperature warning level.
Units	Ω
Range	0 to 2,000,000,000 Ω
Default Value	0 Ω = switched off
Data Type	Integer
See Also	MOTOR.TEMP (pg 577)
Start Version	M_01-00-00-000

Variants Supported

Variant	Supported
AKD Base	Yes
AKD with Position Indexer	Yes
AKD EtherCAT	Yes
AKD CANopen	Yes
AKD BASIC	Yes
AKD SynqNet	Yes
AKD EtherNet/IP	Yes
AKD Profinet	Yes
AKD sercos [®] III	Yes
AKD-N	Yes
AKD-C	No

Fieldbus Information

Fieldbus	Index/Subindex	Object Start Version
EtherCAT COE and CANopen CANopen	3453h/0	M_01-00-00-000

Fieldbus	Address	Attributes	Signed?
Profinet	2259	DWord	No
sercos [®] III		4 Octets	

Fieldbus	Index/Subindex	Is 64 bit?	Attributes	Signed?	Object Start Version
Modbus	518	No	32 bit	No	M_01-03-00-000

Description

This parameter is used to configure the motor temperature warning level as a resistance threshold of the motor PTC.

A zero value prevents any warning from being created.

7.27.32 MOTOR.TYPE

General Information	
Type	NV Parameter
Description	Sets the motor type.
Units	N/A
Range	0, 1, 2, 4, 8
Default Value	0
Data Type	Integer
See Also	N/A
Start Version	M_01-00-00-000

Variants Supported

Variant	Supported
AKD Base	Yes
AKD with Position Indexer	Yes
AKD EtherCAT	Yes
AKD CANopen	Yes
AKD BASIC	Yes
AKD SynqNet	Yes
AKD EtherNet/IP	Yes
AKD Profinet	Yes
AKD sercos [®] III	Yes
AKD-N	Yes
AKD-C	No

Fieldbus Information

Fieldbus	Address	Attributes	Signed?
Profinet	2260	Byte	No
sercos [®] III		2 Octets	

Fieldbus	Index/Subindex	Is 64 bit?	Attributes	Signed?	Object Start Version
Modbus	520	No	8 bit	No	M_01-03-00-000

Description

MOTOR.TYPE sets the drive control algorithms to different motor types as follows:

- 0 = Rotary motor
- 1 = Linear motor
- 2 = Induction Motor V/f Open Loop Control
- 4 = Induction Motor Closed Loop Control
- 8 = Rotary brush motor

The following table shows which MOTOR parameters must be configured for either permanent magnet, induction motor v/f open loop, or induction motor closed loop motor types.

Keyword	Permanent Magnet	Induction Motor v/f Open Loop	Induction Motor Closed Loop
MOTOR.NAME (pg 566)	Yes	Yes	Yes
MOTOR.TYPE	Yes	Yes	Yes
MOTOR.AUTOSET (pg 548)	Yes	No	Yes
MOTOR.IPEAK (pg 560)	Yes	Yes	Yes
MOTOR.ICONT (pg 556)	Yes	Yes	Yes
MOTOR.INERTIA (pg 559)	Yes	Yes	Yes
MOTOR.KT (pg 562)	Yes	No	No
MOTOR.LQLL (pg 565)	Yes	No	Yes
MOTOR.POLES (pg 571)	Yes	Yes	Yes
MOTOR.VMAX (pg 583)	Yes	Yes	Yes
MOTOR.R (pg 572)	Yes	Yes	Yes
MOTOR.VOLTMAX (pg 584)	Yes	Yes	Yes
MOTOR.PHASE (pg 567)	Yes	No	No
MOTOR.CTF0 (pg 555)	Yes	Yes	Yes
MOTOR.KE (pg 561)	Yes	No	No
MOTOR.IMTR	No	No	Yes
MOTOR.IMID	No	No	Yes
MOTOR.VOLTRATED (pg 586)	No	Yes	No
MOTOR.VRATED (pg 587)	No	Yes	No
MOTOR.VOLTMIN (pg 585)	No	Yes	No

7.27.33 MOTOR.VMAX

General Information	
Type	NV Parameter
Description	Sets the maximum motor speed.
Units	rpm
Range	100 to 40,000 rpm
Default Value	3,000 rpm
Data Type	Integer
Start Version	M_01-00-00-000

Variants Supported

Variant	Supported
AKD Base	Yes
AKD with Position Indexer	Yes
AKD EtherCAT	Yes
AKD CANopen	Yes
AKD BASIC	Yes
AKD SynqNet	Yes
AKD EtherNet/IP	Yes
AKD Profinet	Yes
AKD sercos [®] III	Yes
AKD-N	Yes
AKD-C	No

Fieldbus Information

Fieldbus	Index/Subindex	Object Start Version
EtherCAT COE and CANopen CANopen	35A3h/0	M_01-00-00-000

Fieldbus	Address	Attributes	Signed?
Profinet	2261	Word	No
sercos [®] III		2 Octets	

Fieldbus	Index/Subindex	Is 64 bit?	Attributes	Signed?	Object Start Version
Modbus	522	No	16 bit	No	M_01-03-00-000

Description

This parameter sets the maximum motor mechanical speed. The value $1.2 \times \text{MOTOR.VMAX}$ becomes the overall overspeed fault threshold (VL.VFTHRESH) if it is less than the user overspeed fault threshold (VL.THRESH), and for MOTOR.TYPE = 6 if it is less than the motor back EMF overspeed threshold ($(1.02 \times 1000 \times \text{VBUS.OVFTHRESH}) / (\text{MOTOR.KE} \times \text{sqrt}(2))$).

7.27.34 MOTOR.VOLTMAX

General Information	
Type	NV Parameter
Description	Sets the motor maximum voltage.
Units	Vrms
Range	110 to 900 Vrms
Default Value	230 Vrms
Data Type	Integer
See Also	N/A
Start Version	M_01-00-00-000

Variants Supported

Variant	Supported
AKD Base	Yes
AKD with Position Indexer	Yes
AKD EtherCAT	Yes
AKD CANopen	Yes
AKD BASIC	Yes
AKD SynqNet	Yes
AKD EtherNet/IP	Yes
AKD Profinet	Yes
AKD sercos [®] III	Yes
AKD-N	Yes
AKD-C	No

Fieldbus Information

Fieldbus	Index/Subindex	Object Start Version
EtherCAT COE and CANopen CANopen	3452h/0	M_01-00-00-000

Fieldbus	Address	Attributes	Signed?
Profinet	2262	Word	No
sercos [®] III		2 Octets	

Fieldbus	Index/Subindex	Is 64 bit?	Attributes	Signed?	Object Start Version
Modbus	524	No	16 bit	No	M_01-03-00-000

Description

This parameter sets the maximum permissible motor voltage. For instance, if a motor that is rated for a 400 V supply is connected to the drive, then the MOTOR.VOLTMAX setting is 400. This value also sets regen resistor and over voltage thresholds in the drive to acceptable values for the motor so that the motor windings are not damaged.

7.27.35 MOTOR.VOLTMIN

General Information	
Type	NV Parameter
Description	Sets the minimum voltage for V/f control.
Units	%
Range	0 to 100%
Default Value	2%
Data Type	U16
See Also	MOTOR.VRATED (pg 587), MOTOR.VOLTRATED (pg 586)
Start Version	

Variants Supported

Variant	Supported
AKD Base	Yes
AKD with Position Indexer	Yes
AKD EtherCAT	Yes
AKD CANopen	Yes
AKD BASIC	Yes
AKD SynqNet	Yes
AKD EtherNet/IP	Yes
AKD Profinet	Yes
AKD sercos [®] III	Yes
AKD-N	Yes
AKD-C	No

Fieldbus Information

Fieldbus	Index/Subindex	Object Start Version
EtherCAT COE and CANopen CANopen	3457h/3	M_01-00-00-000

Fieldbus	Address	Attributes	Signed?
Profinet	2837	Word	No
sercos [®] III		2 Octets	

Fieldbus	Index/Subindex	Is 64 bit?	Attributes	Signed?	Object Start Version
Modbus	1674	No	16-bit	No	M_01-06-03-000

Description

This parameter configures the drive for the induction motor's minimum voltage at standstill. It is given as a percentage (%) of the motor's rated voltage. MOTOR.VOLTMIN is used to calculate the constant volts per Hertz characteristics of the drive and motor and should be set to a value that generates a current of about 40% of the rated current at standstill.

7.27.36 MOTOR.VOLTRATED

General Information	
Type	NV Parameter
Description	Sets the motor rated voltage.
Units	V
Range	50 to 1,000 V
Default Value	230 V
Data Type	U16
See Also	MOTOR.VRATED (pg 587), MOTOR.VOLTMIN (pg 585)
Start Version	M_01-03-00-000

Variants Supported

Variant	Supported
AKD Base	Yes
AKD with Position Indexer	Yes
AKD EtherCAT	Yes
AKD CANopen	Yes
AKD BASIC	Yes
AKD SynqNet	Yes
AKD EtherNet/IP	Yes
AKD Profinet	Yes
AKD sercos [®] III	Yes
AKD-N	Yes
AKD-C	No

Fieldbus Information

Fieldbus	Index/Subindex	Object Start Version
EtherCAT COE and CANopen CANopen	3457h/2	M_01-03-00-000

Fieldbus	Address	Attributes	Signed?
Profinet	2838	Word	No
sercos [®] III		2 Octets	

Fieldbus	Index/Subindex	Is 64 bit?	Attributes	Signed?	Object Start Version
Modbus	1676	No	16-bit	No	M_01-06-03-000

Description

This parameter configures the drive for the induction motor's rated voltage as indicated on the nameplate. MOTOR.VOLTRATED is used to calculate the constant Volts per Hertz characteristics of the drive and motor.

NOTE

If MOTOR.AUTOSSET = 1 and FB1.MEMVER > 0.01, this parameter will be automatically configured for Kollmorgen motors.

7.27.37 MOTOR.VRATED

General Information	
Type	NV Parameter
Description	Sets the motor rated velocity (not maximum velocity)
Units	Depends on UNIT.VROTARY (pg 720) or UNIT.VLINEAR (pg 719) Rotary: rpm, rps, deg/s, custom units/s, rad/s Linear: counts/s, mm/s, $\mu\text{m/s}$, custom units/s
Range	Rotary: 0.000 to 15,000.000 rpm 0.000 to 250.000 rps 0.000 to 90,000.000 deg/s 0.000 to 1,250.000 custom units/s 0.000 to 1,570.796 rad/s Linear: 0.000 to 1,073,741,824,000.000 counts/s 0.000 to 8,000.000 mm/s 0.000 to 8,000,000.000 $\mu\text{m/s}$ 0.000 to 1,250.000 custom units/s
Default Value	0 rpm
Data Type	U16
See Also	MOTOR.VOLTRATED (pg 586), MOTOR.VOLTMIN (pg 585)
Start Version	M_01-03-00-000

Variants Supported

Variant	Supported
AKD Base	Yes
AKD with Position Indexer	Yes
AKD EtherCAT	Yes
AKD CANopen	Yes
AKD BASIC	Yes
AKD SynqNet	Yes
AKD EtherNet/IP	Yes
AKD Profinet	Yes
AKD sercos [®] III	Yes
AKD-N	Yes
AKD-C	No

Fieldbus Information

Fieldbus	Index/Subindex	Object Start Version
EtherCAT COE and CANopen CANopen	3457h/1	M_01-03-00-000

Fieldbus	Address	Attributes	Signed?
Profinet	2839	DWord	Yes
sercos [®] III		8 Octets	

Fieldbus	Index/Subindex	Is 64 bit?	Attributes	Signed?	Object Start Version
Modbus	1678	Yes	64-bit	Yes	M_01-06-03-000

Description

This parameter configures the drive for the rated velocity of the induction motor as indicated on the nameplate. MOTOR.VRATED is used to calculate the constant volts per Hertz characteristics of the drive and motor.

NOTE

If MOTOR.AUTOSET = 1 and FB1.MEMVER > 0.01, this parameter will be automatically configured for Kollmorgen motors.

7.28 MOVE Parameters

This section describes the MOVE parameters.

NOTE

MOVE parameters are only valid when DRV.OPMODE = 2 and DRV.CMDSOURCE = 5.

7.28.1 MOVE.ABORT	590
7.28.2 MOVE.ACC	591
7.28.3 MOVE.DEC	593
7.28.4 MOVE.DIR	595
7.28.5 MOVE.DWELLTIME	596
7.28.6 MOVE.GOABS	597
7.28.7 MOVE.GOHOME	598
7.28.8 MOVE.GOREL	599
7.28.9 MOVE.GOUPDATE	600
7.28.10 MOVE.GOVEL	601
7.28.11 MOVE.INPOSITION	602
7.28.12 MOVE.INPOSLIMIT	603
7.28.13 MOVE.MOVING	604
7.28.14 MOVE.POSCOMMAND	605
7.28.15 MOVE.RELATIVEDIST	606
7.28.16 MOVE.RUNSPEED	607
7.28.17 MOVE.SCURVETIME	608
7.28.18 MOVE.TARGETPOS	609
7.28.19 MOVE.VCMD	610

7.28.1 MOVE.ABORT

General Information	
Type	Command
Description	MOVE.ABORT stops motor motion and allows continued program execution.
Units	N/A
Range	N/A
Default Value	N/A
Data Type	N/A

Fieldbus Information

Fieldbus	Index/Subindex	Is 64 bit?	Attributes	Signed?	Object Start Version
Modbus	1144	No	Command	No	M_01-05-11-000

Description

MOVE.ABORT stops motor motion and allows continued program execution. Deceleration is determined by CS.DEC.

NOTE

MOVE parameters are only valid when DRV.OPMODE = 2 and DRV.CMDSOURCE = 5.

Example

This program segment commands the motor at constant velocity until input 1 goes to a logic 0. Then, the motor is commanded to stop.

```
MOVE.ACC = 5000
`Set acceleration rate equal to 5,000 rpm/sec
CS.DEC = 10000
`Set controlled stop deceleration rate to 10,000 rpm/sec
MOVE.RUNSPEED = 120
`Set Run speed equal to 120 rpm
MOVE.GOVEL
When DIN2.STATE = 0, MOVE.ABORT
`Motor decelerates to a stop at CS.DEC (10,000 rpm/sec)
Print "Move Aborted!"
```

Related Topics

Stop (pg 137) | CS.DEC (pg 253)

7.28.2 MOVE.ACC

General Information	
Type	R/W
Description	Sets the maximum commanded acceleration rate when the speed is increased.
Units	Depends on UNIT.ACCROTARY (pg 713) or UNIT.ACCLINEAR (pg 712) Rotary: rps/s, rpm/s, deg/s ² , (Custom Units)/s ² , rad/s ² Linear: counts/s ² , mm/s ² , μm/s ² , (Custom Units)/s ²
Range	Note: The range and default values of (Custom Units)/s ² units depend on the values of PIN and POUT. The range and default values listed in this table are derived from the default values of PIN and POUT. Rotary: 0.004 to 8,000,000 rps/s 0.224 to 480,000,016.384 rpm/s 1.341 to 2,879,999,967.232 deg/s ² 0.019 to 40,000,000 (Custom Units)/s ² 0.023 to 50,265,481.216 rad/s ² Linear: 16,000,000 to 15,912,994,294,290,448.384 counts/s ² 0.119*MOTOR.PITCH (pg 570) to 256,000,000*MOTOR.PITCH (pg 570) mm/s ² 119.209*MOTOR.PITCH (pg 570) to 255,999,998,951.424*MOTOR.PITCH (pg 570) μm/s ² 0.019 to 40,000,000(Custom Units)/s ²
Default Value	Note: The range and default values of (Custom Units)/s ² units depend on the values of PIN and POUT. The range and default values listed in this table are derived from the default values of PIN and POUT. Rotary: 166.666 rps/s 9,999.946 rpm/s 59,999.676 deg/s ² 833.329 (Custom Units)/s ² 1047.192 rad/s ² Linear: 715,824,012,722.176 counts/s ² 5,333.305*MOTOR.PITCH (pg 570) mm/s ² 5,333,304.320*MOTOR.PITCH (pg 570) μm/s ² 833.329 (Custom Units)/s ²
Data Type	Float

Fieldbus Information

Fieldbus	Index/Subindex	Is 64 bit?	Attributes	Signed?	Object Start Version
Modbus	1088	Yes	64 bit	No	M_01-05-11-000

Description

Sets the maximum commanded acceleration rate when the speed is increased. Set MOVE.ACC prior to initiating the move. You can update MOVE.ACC during a move by executing an MOVE.GOUUPDATE statement.

NOTE

MOVE parameters are only valid when DRV.OPMODE = 2 and DRV.CMDSOURCE = 5.

Example

```
'This example sets MOVE.ACC to 10,000 rpm/sec and does a  
'relative move of 10 motor revolutions.  
MOVE.RUNSPEED = 1000  
MOVE.ACC = 10000  
MOVE.DEC = 10000  
MOVE.RELATIVEDIST = 655360  
MOVE.GOREL
```

Related Topics

MOVE.DEC (pg 593)

7.28.3 MOVE.DEC

General Information	
Type	R/W
Description	Sets the maximum commanded deceleration rate when the speed is decreased.
Units	Depends on UNIT.ACCROTARY (pg 713) or UNIT.ACCLINEAR (pg 712) Rotary: rps/s, rpm/s, deg/s ² , (Custom Units)/s ² , rad/s ² Linear: counts/s ² , mm/s ² , μm/s ² , (Custom Units)/s ²
Range	Note: The range and default values of (Custom Units)/s ² units depend on the values of PIN and POUT. The range and default values listed in this table are derived from the default values of PIN and POUT. Rotary: 0.004 to 8,000,000 rps/s 0.224 to 480,000,016.384 rpm/s 1.341 to 2,879,999,967.232 deg/s ² 0.004 to 8,000,000 (Custom Units)/s ² 0.023 to 50,265,481.216 rad/s ² Linear: 16,000,000 to 15,912,994,294,290,448.384 counts/s ² 0.119*MOTOR.PITCH (pg 570) to 256,000,000*MOTOR.PITCH (pg 570) mm/s ² 119.209*MOTOR.PITCH (pg 570) to 255,999,998,951.424*MOTOR.PITCH (pg 570) μm/s ² 0.004 to 8,000,000 (Custom Units)/s ²
Default Value	Note: The range and default values of (Custom Units)/s ² units depend on the values of PIN and POUT. The range and default values listed in this table are derived from the default values of PIN and POUT. Rotary: 166.669 rps/s 10,000.170 rpm/s 60,001.016 deg/s ² 166.669 (Custom Units)/s ² 1047.215 rad/s ² Linear: 715,839,984,631.808 counts/s ² 5,333.424*MOTOR.PITCH (pg 570) mm/s ² 53,33,423.616*MOTOR.PITCH (pg 570) μm/s ² 166.669 (Custom Units)/s ²
Data Type	Float

Fieldbus Information

Fieldbus	Index/Subindex	Is 64 bit?	Attributes	Signed?	Object Start Version
Modbus	1092	Yes	64 bit	No	M_01-05-11-000

Description

Sets the maximum commanded deceleration rate when the speed is decreased. Set MOVE.DEC prior to initiating the move. You can update MOVE.DEC during a move by executing an MOVE.GOUPDATE statement.

NOTE

MOVE parameters are only valid when DRV.OPMODE = 2 and DRV.CMDSOURCE = 5.

Example

```
'This example sets MOVE.DEC to 5,000 rpm/sec and does a  
'relative move of 10 motor revolutions.  
MOVE.RUNSPEED = 1000  
MOVE.ACC = 10000  
MOVE.DEC = 10000  
MOVE.RELATIVEDIST = 655360  
MOVE.GOREL
```

Related Topics

MOVE.ACC (pg 591)

7.28.4 MOVE.DIR

General Information	
Type	R/W parameter
Description	MOVE.DIR specifies the direction the motor turns when a MOVE.GOVEL statement is executed.
Units	none
Range	0 or 1
Default Value	0
Data Type	Integer

Fieldbus Information

Fieldbus	Index/Subindex	Is 64 bit?	Attributes	Signed?	Object Start Version
Modbus	1096	No	32 bit	No	M_01-05-11-000

Description

MOVE.DIR specifies the direction the motor turns when a MOVE.GOVEL statement is executed. It has no effect on any other motion statements. If MOVE.DIR = 0, the motor turns in the positive direction. If MOVE.DIR = 1, the motor turns in the negative direction.

NOTE

MOVE parameters are only valid when DRV.OPMODE = 2 and DRV.CMDSOURCE = 5.

7.28.5 MOVE.DWELLTIME

General Information	
Type	R/W
Description	Adds a dwell time at the end of a MOVE.GOREL or MOVE.GOABS move that will elapse before MOVE.MOVING is set equal to 0.
Units	msecs
Range	0 to 2,147,483,647
Default Value	0
Data Type	Integer

Fieldbus Information

Fieldbus	Index/Subindex	Is 64 bit?	Attributes	Signed?	Object Start Version
Modbus	1182	No	32 bit	No	M_01-05-11-000

Description

MOVE.DWELLTIME will add a pause after a Relative or absolute move is complete before the MOVE.MOVING flag is set to 0.

NOTE

MOVE parameters are only valid when DRV.OPMODE = 2 and DRV.CMDSOURCE = 5.

Example

```
MOVE.RUNSPEED = 1000
MOVE.DWELLTIME = 5000
MOVE.RELATIVEDIST = 65536
MOVE.GOREL
'Wait for move to complete and pause 5 seconds
While MOVE.MOVING = 1 : Wend
```

Related Topics

MOVE.GOABS (pg 597) | MOVE.GOREL (pg 599)

7.28.6 MOVE.GOABS

General Information	
Type	Command
Description	MOVE.GOABS moves the motor to the position specified by MOVE.TARGETPOS.
Units	N/A
Range	N/A
Default Value	N/A
Data Type	N/A

Fieldbus Information

Fieldbus	Index/Subindex	Is 64 bit?	Attributes	Signed?	Object Start Version
Modbus	1098	No	Command	No	M_01-05-11-000

Description

MOVE.GOABS (Go to Absolute Position) causes the motor to move to the position specified by MOVE.TARGETPOS. This is an absolute position referenced to the position where PL.FB = 0.

Program execution continues with the line immediately following the MOVE.GOABS statement as soon as the move is initiated. Program execution does not wait until the move is complete.

NOTE

MOVE parameters are only valid when DRV.OPMODE = 2 and DRV.CMDSOURCE = 5.

Related Topics

MOVE.POSCOMMAND (pg 605) | MOVE.ACC (pg 591) | MOVE.DEC (pg 593) | MOVE.RUNSPEED (pg 607) | MOVE.ABORT (pg 590) | MOVE.GOHOME (pg 598) | MOVE.MOVING (pg 604) | MOVE.INPOSITION (pg 602)

7.28.7 MOVE.GOHOME

General Information	
Type	Command
Description	MOVE.GOHOME causes the motor to move to the position specified where PL.FB = 0.
Units	N/A
Range	N/A
Default Value	N/A
Data Type	N/A

Fieldbus Information

Fieldbus	Index/Subindex	Is 64 bit?	Attributes	Signed?	Object Start Version
Modbus	1102	No	Command	No	M_01-05-11-000

Description

MOVE.GOHOME causes the motor to move to the position specified where PL.FB = 0. MOVE.GOHOME is identical to MOVE.GOABS with MOVE.TARGETPOS = 0. The motor speed follows a velocity profile as specified by MOVE.ACC, MOVE.DEC, and MOVE.RUNSPEED. This profile may be modified during the move using MOVE.GOUPDATE.

Program execution continues with the line immediately following the MOVE.GOHOME statement as soon as the move is initiated. Program execution does not wait until the move is complete.

The drive must be enabled in order for any motion to take place.

NOTE

MOVE parameters are only valid when DRV.OPMODE = 2 and DRV.CMDSOURCE = 5.

Related Topics

MOVE.POSCOMMAND (pg 605) | MOVE.ACC (pg 591) | MOVE.DEC (pg 593) | MOVE.RUNSPEED (pg 607) | MOVE.ABORT (pg 590) | MOVE.GOABS (pg 597) | MOVE.MOVING (pg 604) | MOVE.INPOSITION (pg 602)

7.28.8 MOVE.GOREL

General Information	
Type	Command
Description	MOVE.GOREL moves the motor a distance specified by MOVE.RELATIVEDIST.
Units	N/A
Range	N/A
Default Value	N/A
Data Type	N/A

Fieldbus Information

Fieldbus	Index/Subindex	Is 64 bit?	Attributes	Signed?	Object Start Version
Modbus	1106	No	Command	No	M_01-05-11-000

Description

MOVE.GOREL (Go Relative) moves the motor a distance specified by MOVE.RELATIVEDIST.

The motor speed follows a velocity profile as specified by MOVE.ACC, MOVE.DEC, and MOVE.RUNSPEED. This profile may be modified during the move using MOVE.GOUPDATE.

Program execution continues with the line immediately following the MOVE.GOREL statement as soon as the move is initiated. Program execution does not wait until the move is complete.

The drive must be enabled in order for any motion to take place.

NOTE

MOVE parameters are only valid when DRV.OPMODE = 2 and DRV.CMDSOURCE = 5.

Related Topics

MOVE.POSCOMMAND (pg 605) | MOVE.ACC (pg 591) | MOVE.DEC (pg 593) | MOVE.RUNSPEED (pg 607) | MOVE.ABORT (pg 590) | MOVE.GOABS (pg 597) | MOVE.MOVING (pg 604) | MOVE.INPOSITION (pg 602)

7.28.9 MOVE.GOUPDATE

General Information	
Type	Command
Description	MOVE.GOUPDATE updates a move in progress with new move parameters.
Units	N/A
Range	N/A
Default Value	N/A
Data Type	N/A

Fieldbus Information

Fieldbus	Index/Subindex	Is 64 bit?	Attributes	Signed?	Object Start Version
Modbus	1108	No	Command	No	M_01-05-11-000

Description

MOVE.GOUPDATE updates a move in progress with new move parameters. This allows you to change motion on-the-fly. MOVE.GOUPDATE updates MOVE.ACC, MOVE.DEC, MOVE.DIR, and MOVE.RUNSPEED.

Program execution continues with the line immediately following the MOVE.GOUPDATE statement as soon as the move is initiated. Program execution does not wait until the move is complete. The drive must be enabled in order for any motion to take place.

MOVE.GOUPDATE does not initiate motion if there is no move in progress, the MOVE.GOUPDATE statement is ignored.

NOTE

MOVE parameters are only valid when DRV.OPMODE = 2 and DRV.CMDSOURCE = 5.

Related Topics

MOVE.GOREL (pg 599) | MOVE.GOABS (pg 597) | MOVE.GOVEL (pg 601) | MOVE.GOHOME (pg 598)

7.28.10 MOVE.GOVEL

General Information	
Type	Command
Description	MOVE.GOVEL moves the motor at a constant speed specified by MOVE.RUNSPEED and direction specified by MOVE.DIR.
Units	N/A
Range	N/A
Default Value	N/A
Data Type	N/A

Fieldbus Information

Fieldbus	Index/Subindex	Is 64 bit?	Attributes	Signed?	Object Start Version
Modbus	1110	No	Command	No	M_01-05-11-000

Description

MOVE.GOVEL (Go at Velocity) moves the motor at a constant speed specified by MOVE.RUNSPEED and direction specified by MOVE.DIR.

The motor speed follows a velocity profile as specified by MOVE.ACC, MOVE.DEC, and MOVE.RUNSPEED. This profile may be modified during the move using MOVE.GOUPDATE.

Program execution continues with the line immediately following MOVE.GOVEL as soon as the move is initiated. Program execution does not wait until the move is complete.

The drive must be enabled in order for any motion to take place.

NOTE

MOVE parameters are only valid when DRV.OPMODE = 2 and DRV.CMDSOURCE = 5.

Related Topics

MOVE.GOREL (pg 599) | MOVE.GOABS (pg 597) | MOVE.GOVEL (pg 601) | MOVE.GOHOME (pg 598)

7.28.11 MOVE.INPOSITION

General Information	
Type	R/O
Description	Indicates whether or not the motor has achieved command position.
Units	none
Range	0 or 1
Default Value	0
Data Type	Integer

Fieldbus Information

Fieldbus	Index/Subindex	Is 64 bit?	Attributes	Signed?	Object Start Version
Modbus	1112	No	32 bit	No	M_01-05-11-000

Description

MOVE.INPOSITION is used for monitoring move commands to ensure that the desired motion has been completed. MOVE.INPOSITION is always 0 (False) or 1 (True).

MOVE.INPOSITION is 1 (True) if all the following are true:

- Drive is enabled.
- MOVE.MOVING = 0
- PL.ERR less than MOVE.INPOSLIMIT

NOTE

MOVE parameters are only valid when DRV.OPMODE = 2 and DRV.CMDSOURCE = 5.

Related Topics

MOVE.MOVING (pg 604)

7.28.12 MOVE.INPOSLIMIT

General Information	
Type	R/W
Description	Specifies the tolerance of Position Error (PL.ERR) within which the MOVE.INPOSITION flag will be set to 1 (True).
Units	16 bit counts
Range	0 to 140,737,488,355,328
Default Value	0
Data Type	Integer

Fieldbus Information

Fieldbus	Index/Subindex	Is 64 bit?	Attributes	Signed?	Object Start Version
Modbus	1114	Yes	64 bit	Yes	M_01-05-11-000

Description

Specifies the tolerance of Position Error (PL.ERR) within which the MOVE.INPOSITION flag will be set to 1 (True). Set MOVE.INPOSLIMIT before using MOVE.INPOSITION.

NOTE

MOVE parameters are only valid when DRV.OPMODE = 2 and DRV.CMDSOURCE = 5.

Related Topics

MOVE.INPOSITION (pg 602)

7.28.13 MOVE.MOVING

General Information	
Type	R/O
Description	Indicates whether or not the commanded motion profile is complete.
Units	N/A
Range	0 or 1
Default Value	0
Data Type	Integer

Fieldbus Information

Fieldbus	Index/Subindex	Is 64 bit?	Attributes	Signed?	Object Start Version
Modbus	1118	No	32 bit	No	M_01-05-11-000

Description

MOVE.MOVING only indicates whether or not the commanded motion profile for MOVE.GOREL, MOVE.GOABS, MOVE.GOHOME, and MOVE.GOVEL is complete. Even when the commanded motion profile is completed (MOVE.MOVING = 0), there may still be motor motion as the result of settling time and/or electronic gearing. MOVE.MOVING is not applicable for EGEAR commands.

0 - commanded motion complete

1 - move in progress

NOTE

MOVE parameters are only valid when DRV.OPMODE = 2 and DRV.CMDSOURCE = 5.

Example

```
MOVE.RELATIVEDIST = 10000
MOVE.GOREL
While MOVE.MOVING : Wend
Pause (0.5)
MOVE.RELATIVEDIST = -MOVE.RELATIVEDIST
MOVE.GOREL
```

Related Topics

MOVE.INPOSITION (pg 602) | MOVE.INPOSITION (pg 602) | MOVE.GOREL (pg 599) | MOVE.GOABS (pg 597) | MOVE.GOHOME (pg 598) | MOVE.GOVEL (pg 601)

7.28.14 MOVE.POSCOMMAND

General Information	
Type	R/W
Description	Current Position Command from Trajectory Generator.
Units	Depends on UNIT.PROTARY (pg 718) or UNIT.PLINEAR (pg 716)UNIT.ACCLINEAR (pg 712) Rotary: counts, rad, deg, (Custom Units), 16-bit counts Linear: counts, mm, µm, (Custom Units), 16-bit counts
Range	N/A
Default Value	N/A
Data Type	Integer

Fieldbus Information

Fieldbus	Index/Subindex	Is 64 bit?	Attributes	Signed?	Object Start Version
Modbus	1120	Yes	64 bit	Yes	M_01-05-11-000

Description

MOVE.POSCOMMAND contains the current position command from the trajectory generator.

The value of MOVE.POSCOMMAND is affected by MOVE.POSMODULO and MOVE.POSPOLARITY.

MOVE.POSCOMMAND can be used to determine the position being commanded. You can write to MOVE.POSCOMMAND at any time; to establish a new home position (where MOVE.POSCOMMAND = 0). Writing to MOVE.POSCOMMAND will not affect motor motion.

NOTE

MOVE parameters are only valid when DRV.OPMODE = 2 and DRV.CMDSOURCE = 5.

Example

```
'set electrical home position when DIN1.STATE goes to 0.
'-----
MOVE.DIR = 0 : MOVE.RUNSPEED = 100 : MOVE.GOVEL
When DIN1.STATE = 0, Continue
MOVE.ABORT
While MOVE.MOVING : Wend
MOVE.POSCOMMAND = 0
```

7.28.15 MOVE.RELATIVEDIST

General Information	
Type	R/W
Description	Specifies the distance the motor turns during a relative move (MOVE.GOREL).
Units	Depends on UNIT.PROTARY (pg 718) or UNIT.PLINEAR (pg 716)UNIT.ACCLINEAR (pg 712) Rotary: counts, rad, deg, (Custom Units), 16-bit counts Linear: counts, mm, µm, (Custom Units), 16-bit counts
Range	N/A
Default Value	N/A
Data Type	Integer

Fieldbus Information

Fieldbus	Index/Subindex	Is 64 bit?	Attributes	Signed?	Object Start Version
Modbus	1134	Yes	64 bit	Yes	M_01-05-11-000

Description

MOVE.RELATIVEDIST specifies the distance the motor moves during a relative move (MOVE.GOREL). Specify MOVE.RELATIVEDIST before initiating MOVE.GOREL.

NOTE

MOVE parameters are only valid when DRV.OPMODE = 2 and DRV.CMDSOURCE = 5.

Example

```
'This example sets Move.RelativeDist to 655360 (10 motor revolu
'tions, assuming units is 16 bit position units or 65536
'counts/rev) and does a relative move.
MOVE.RUNSPEED = 1000
MOVE.ACC = 10000
MOVE.DEC = 5000
MOVE.RELATIVEDIST = 655360
MOVE.GOREL
```

Related Topics

MOVE.ACC (pg 591) | MOVE.DEC (pg 593) | MOVE.RUNSPEED (pg 607)

7.28.16 MOVE.RUNSPEED

General Information	
Type	R/W
Description	Sets the maximum speed allowed during a relative (MOVE.GOREL) or absolute (MOVE.GOABS) move, and sets the commanded speed during a velocity move (MOVE.GOVEL).
Units	Depends on UNIT.VROTARY (pg 720) or UNIT.VLINEAR (pg 719)UNIT.ACCLINEAR (pg 712) Rotary: rpm, rps, deg/s, (Custom Units)/s, rad/s Linear: counts/s, mm/s, µm/s, (Custom Units)/s
Range	N/A
Default Value	N/A
Data Type	Float

Fieldbus Information

Fieldbus	Index/Subindex	Is 64 bit?	Attributes	Signed?	Object Start Version
Modbus	1138	Yes	64 bit	No	M_01-05-11-000

Description

Sets the maximum speed allowed during an incremental (MOVE.GOREL) or absolute (MOVE.GOABS) move, and sets the commanded speed during a velocity move (MOVE.GOVEL). Specify MOVE.RUNSPEED before initiating any move commands.

NOTE

MOVE parameters are only valid when DRV.OPMODE = 2 and DRV.CMDSOURCE = 5.

Related Topics

MOVE.GOVEL (pg 601) | MOVE.GOREL (pg 599)

7.28.17 MOVE.SCURVETIME

General Information	
Type	R/W
Description	Sets the amount of S-curve smoothing applied to all velocity profiles.
Units	Milliseconds
Range	0 to 512 (0, 0.5, 1, 2, 4, 8, 16, 32, 64, 128, 256, 512)
Default Value	0
Data Type	Float

Fieldbus Information

Fieldbus	Index/Subindex	Is 64 bit?	Attributes	Signed?	Object Start Version
Modbus	1142	No	32 bit	No	M_01-05-11-000

Description

MOVE.SCURVETIME sets the amount of S-curve smoothing applied to all velocity profiles. The greater the value of MOVE.SCURVETIME, the smoother (lower jerk) the profile.

Specifying a non-zero value for MOVE.SCURVETIME increases move time by MOVE.SCURVETIME. For example, a trapezoidal move (MOVE.SCURVETIME = 0) that takes 0.500 seconds to complete, takes 0.756 seconds to complete if MOVE.SCURVETIME is set to 256.

Change MOVE.SCURVETIME only when the motor is not moving (MOVE.MOVING = 0). If you attempt to change MOVE.SCURVETIME while the motor is moving a RunTime error is produced.

NOTE

MOVE parameters are only valid when DRV.OPMODE = 2 and DRV.CMDSOURCE = 5.

Related Topics

MOVE.ACC (pg 591) | MOVE.DEC (pg 593) | MOVE.GOREL (pg 599) | MOVE.GOABS (pg 597) | MOVE.GOHOME (pg 598) | MOVE.GOVEL (pg 601)

7.28.18 MOVE.TARGETPOS

General Information	
Type	R/W
Description	MOVE.TARGETPOS specifies the target position for an absolute (MOVE.GOABS) move.
Units	Depends on UNIT.PROTARY (pg 718) or UNIT.PLINEAR (pg 716)UNIT.ACCLINEAR (pg 712) Rotary: counts, rad, deg, (Custom Units), 16-bit counts Linear: counts, mm, µm, (Custom Units), 16-bit counts
Range	N/A
Default Value	N/A
Data Type	Integer

Fieldbus Information

Fieldbus	Index/Subindex	Is 64 bit?	Attributes	Signed?	Object Start Version
Modbus	1146	Yes	64 bit	Yes	M_01-05-11-000

Description

MOVE.TARGETPOS specifies the target position for an absolute (MOVE.GOABS) move.

MOVE.TARGETPOS is an absolute position referenced to the electrical home position (the position where PL.FB = 0).

Set MOVE.TARGETPOS before initiating a MOVE.GOABS.

NOTE

MOVE parameters are only valid when DRV.OPMODE = 2 and DRV.CMDSOURCE = 5.

Related Topics

MOVE.GOABS (pg 597)

7.28.19 MOVE.VCMD

General Information	
Type	R/O
Description	Trajectory Generator Velocity Command.
Units	Depends on UNIT.VROTARY (pg 720), UNIT.VLINEAR (pg 719) or UNIT.ACCLINEAR (pg 712) Rotary: rpm, rps, deg/s, (custom units)/s, rad/s Linear: counts/s, mm/s, μ m/s, (custom units) /s
Range	N/A
Default Value	N/A
Data Type	Float

Fieldbus Information

Fieldbus	Index/Subindex	Is 64 bit?	Attributes	Signed?	Object Start Version
Modbus	1150	No	32 bit	No	M_01-05-11-000

Description

MOVE.VCMD reflects the velocity commanded by the Trajectory Generator when DRV.CMDSOURCE = 5 (program) and DRV.OPMODE = 2 (position). MOVE.VCMD is only valid when DRV.CMDSOURCE = 5 (program) and DRV.OPMODE = 2 (position).

Related Topics

DRV.CMDSOURCE (pg 312) | DRV.OPMODE (pg 370)

7.29 PL Parameters

This section describes the PL parameters.

7.29.1 PL.CMD	612
7.29.2 PL.ERR	613
7.29.3 PL.ERRFTHRESH	615
7.29.4 PL.ERRMODE	617
7.29.5 PL.ERRWTHRESH	619
7.29.6 PL.FB	621
7.29.7 PL.FBSOURCE	623
7.29.8 PL.INTINMAX	624
7.29.9 PL.INTOUTMAX	626
7.29.10 PL.KI	628
7.29.11 PL.KP	629
7.29.12 PL.MODP1	630
7.29.13 PL.MODP2	632
7.29.14 PL.MODPDIR	634
7.29.15 PL.MODPEN	636

7.29.1 PL.CMD

General Information	
Type	R/O Parameter
Description	Reads the position command directly from the entry to the position loop.
Units	Depends on UNIT.PLINEAR (pg 716) or UNIT.PROTARY (pg 718) Rotary: counts, rad, deg, (custom units), 16-bit counts Linear: counts, mm, µm, (custom units), 16-bit counts
Range	N/A
Default Value	N/A
Data Type	Float
See Also	PL.FB (pg 621)
Start Version	M_01-00-00-000

AKD BASIC Information	
Data Type	Integer

Variants Supported

Variant	Supported
AKD Base	Yes
AKD with Position Indexer	Yes
AKD EtherCAT	Yes
AKD CANopen	Yes
AKD BASIC	Yes
AKD SynqNet	Yes
AKD EtherNet/IP	Yes
AKD Profinet	Yes
AKD sercos [®] III	Yes
AKD-N	Yes
AKD-C	No

Fieldbus Information

Fieldbus	Address	Attributes	Signed?
Profinet	2285	DWord	No
sercos [®] III		8 Octets	

Fieldbus	Index/Subindex	Is 64 bit?	Attributes	Signed?	Object Start Version
Modbus	570	Yes	64 bit	No	M_01-03-00-000

Description

PL.CMD reads the position command as it is received in the position loop entry.

Related Topics

PL.ERR (pg 613) | PL.ERRFTHRESH (pg 615) | PL.ERRMODE (pg 617) | PL.ERRWTHRESH (pg 619)

7.29.2 PL.ERR

General Information	
Type	R/O Parameter
Description	Reads the position error present when the drive is controlling the position loop.
Units	counts, rad, deg, (custom units)
Range	N/A
Default Value	N/A
Data Type	Float
See Also	PL.FB (pg 621)
Start Version	M_01-00-00-000

AKD BASIC Information	
Data Type	Integer

Variants Supported

Variant	Supported
AKD Base	Yes
AKD with Position Indexer	Yes
AKD EtherCAT	Yes
AKD CANopen	Yes
AKD BASIC	Yes
AKD SynqNet	Yes
AKD EtherNet/IP	Yes
AKD Profinet	Yes
AKD sercos [®] III	Yes
AKD-N	Yes
AKD-C	No

Fieldbus Information

Fieldbus	Index/Subindex	Object Start Version
EtherCAT COE and CANopen CANopen	35C5h/0 60F4h/0	M_01-00-00-000

Fieldbus	Address	Attributes	Signed?
Profinet	2287	DWord	No
sercos [®] III		8 Octets	

Fieldbus	Index/Subindex	Is 64 bit?	Attributes	Signed?	Object Start Version
Modbus	574	Yes	64 bit	No	M_01-03-00-000

Description

PL.ERR reads the position error present when the drive is controlling the position loop. PL.ERR is the difference between the actual position of the motor shaft (PL.FB (pg 621)) and the commanded position of the drive (PL.CMD (pg 612)). If the drive is not in the position operating mode (DRV.OPMODE (pg 370) = 2), then the PL.ERR value is not generated by the drive and this parameter is read as 0.

AKD BASIC Notes

NOTE

When you enable the position error interrupt (by setting `INTR.PL.ERR=1`), the Position Error fault is disabled. In situations where it would have occurred, a position error interrupt is generated instead.

Related Topics

[PL.ERRFTHRESH \(pg 615\)](#) | [PL.ERRMODE \(pg 617\)](#) | [PL.ERRWTHRESH \(pg 619\)](#)

7.29.3 PL.ERRFTHRESH

General Information	
Type	NV Parameter
Description	Sets the maximum position error.
Units	Depends UNIT.ACCROTARY (pg 713) on or UNIT.ACCLINEAR (pg 712) Rotary: counts, rad, deg, (custom units), 16-bit counts Linear: counts, mm, μm , (custom units), 16-bit counts
Range	Rotary: 0.000 to 5,123,372,000,000,005.000 counts 0.000 to 7,495,067.136 rad 0.000 to 429,436,076.032 deg 0.000 to 5,964,389.888 (custom units) 0.000 to 78,176,452,636.718 16-bit counts Linear: 0.000 to 5,123,372,000,000,005.000 counts 0.000 to 1,192,877.952*MOTOR.PITCH (pg 570) mm 0.000 to 1,192,878,014.464*MOTOR.PITCH (pg 570) μm 0.000 to 5,964,389.888 (custom units) 0.000 to 78,176,452,636.718 16-bit counts
Default Value	Rotary: 42,949,672,960.000 counts 62.832 rad 3,600.000 deg 50.000 (custom units) 655,360.000 16-bit counts Linear: 42,949,672,960.000 counts 10.000*MOTOR.PITCHMOTOR.PITCH (pg 570)mm 10,000.000*MOTOR.PITCH μm 50.000 (custom units) 655,360.000 16-bit counts
Data Type	Float
See Also	PL.ERR
Start Version	M_01-00-00-000

AKD BASIC Information

Data Type	Integer
-----------	---------

Variants Supported

Variant	Supported
AKD Base	Yes
AKD with Position Indexer	Yes
AKD EtherCAT	Yes
AKD CANopen	Yes

Variant	Supported
AKD BASIC	Yes
AKD SynqNet	Yes
AKD EtherNet/IP	Yes
AKD Profinet	Yes
AKD sercos [®] III	Yes
AKD-N	Yes
AKD-C	No

Fieldbus Information

Fieldbus	Index/Subindex	Object Start Version
EtherCAT COE and CANopen CANopen	35C7h/0 6065h/0	M_01-00-00-000

Fieldbus	Address	Attributes	Signed?
Profinet	2290	DWord	No
sercos [®] III		8 Octets	

Fieldbus	Index/Subindex	Is 64 bit?	Attributes	Signed?	Object Start Version
Modbus	580	Yes	64 bit	No	M_01-03-00-000

Description

This parameter sets the maximum position error. If the position error PL.ERR (pg 613) is larger than PL.ERRFTHRESH the drive generates a fault. If PL.ERRFTHRESH is set to 0, the maximum position error is ignored.

Example

Set position rotary units to 2 (degrees). Setting PL.ERRFTHRESH to 1000 states that is the position error is larger than 1000 degrees, the drive will generate a fault.

```
UNIT.PROTARY 2
```

```
PL.ERRFTHRESH 1000
```

Related Topics

PL.ERR (pg 613) | PL.ERRMODE (pg 617) | PL.ERRWTHRESH (pg 619)

7.29.4 PL.ERRMODE

General Information	
Type	NV Parameter
Description	Sets the type of following error warning and fault usage.
Units	0- Standard following error 1-Enhanced following error
Range	0 to 1
Default Value	0
Data Type	Boolean
See Also	PL.ERR (pg 613), PL.ERRFTHRESH (pg 615), PL.ERRWTHRESH (pg 619)
Start Version	M_01-02-09-000

AKD BASIC Information	
Data Type	Integer

Variants Supported

Variant	Supported
AKD Base	Yes
AKD with Position Indexer	Yes
AKD EtherCAT	Yes
AKD CANopen	Yes
AKD BASIC	Yes
AKD SynqNet	Yes
AKD EtherNet/IP	Yes
AKD Profinet	Yes
AKD sercos [®] III	Yes
AKD-N	Yes
AKD-C	No

Fieldbus Information

Fieldbus	Address	Attributes	Signed?
Profinet	2289	Byte	No
sercos [®] III		2 Octets	

Fieldbus	Index/Subindex	Is 64 bit?	Attributes	Signed?	Object Start Version
Modbus	578	No	8 bit	No	M_01-03-00-000

Description

PL.ERRMODE sets the type of following error warning and fault usage.

Mode 0 - following error magnitude fault

In Mode 0, the values of PL.ERRFTHRESH and PL.ERRWTHRESH are compared against the value of PL.ERR. If the absolute value of PL.ERR is larger than PL.ERRWTHRESH, then a warning is generated. If the absolute value of PL.ERR is larger than PL.ERRFTHRESH, then a fault is generated.

Mode 1 - deviation from predicted trajectory fault

In Mode 1, the values of PL.ERRFTHRESH and PL.ERRWTHRESH are compared against the following value:

$$\langle \text{error} \rangle = \text{abs}(\text{PL.ERR} - [(\text{VL.CMD} - 1 * \text{VL.FF}) / \text{PL.KP}])$$

If the absolute value of $\langle \text{error} \rangle$ is larger than PL.ERRWTHRESH for a consecutive period of 100 ms, then a warning is generated. If the absolute value of $\langle \text{error} \rangle$ is larger than PL.ERRFTHRESH for a consecutive period of 100 ms, then a fault is generated.

In mode 1, if PL.KI is not 0 then the following error prediction mechanism is turned off. When the drive is disabled, the following error limit tests are turned off and the warnings are cleared. A value of 0 in PL.ERRFTHRESH or PL.ERRWTHRESH disables the respective functionality.

Example

Assuming

PL.ERRMODE = 0, PL.ERRFTHRESH=1.2, PL.ERRWTHRESH=1, then PL.ERR reads 1.1.

In this case the warning is generated, but the fault is not.

Assuming PL.ERRMODE = 0, PL.ERRFTHRESH=1.2, PL.ERRWTHRESH=1, then PL.ERR reads 1.3.

In this case the warning is generated, as well as the fault.

Related Topics

PL.ERR (pg 613) | PL.ERRFTHRESH (pg 615) | PL.ERRWTHRESH (pg 619)

7.29.5 PL.ERRWTHRESH

General Information	
Type	NV Parameter
Description	Sets the position error warning level.
Units	Depends on UNIT.PLINEAR (pg 716) or UNIT.PROTARY (pg 718) Rotary: counts, rad, deg, (custom units), 16-bit counts Linear: counts, mm, µm, (custom units), 16-bit counts
Range	Rotary: 0.000 to 5,123,372,000,000,005.000 counts 0.000 to 7,495,067.136 rad 0.000 to 429,436,076.032 deg 0.000 to 5,964,389.888 (custom units) 0.000 to 78,176,452,636.718 16-bit counts Linear: 0.000 to 5,123,372,000,000,005.000 counts 0.000 to 1,192,877.952*MOTOR.PITCH (pg 570) mm 0.000 to 1,192,878,014.464*MOTOR.PITCH (pg 570) µm 0.000 to 5,964,389.888 (custom units) 0.000 to 78,176,452,636.718 16-bit counts
Default Value	0.000 deg
Data Type	Float
See Also	PL.ERR (pg 613)
Start Version	M_01-00-00-000

AKD BASIC Information	
Data Type	Integer

Variants Supported

Variant	Supported
AKD Base	Yes
AKD with Position Indexer	Yes
AKD EtherCAT	Yes
AKD CANopen	Yes
AKD BASIC	Yes
AKD SynqNet	Yes
AKD EtherNet/IP	Yes
AKD Profinet	Yes
AKD sercos [®] III	Yes
AKD-N	Yes
AKD-C	No

Fieldbus Information

Fieldbus	Index/Subindex	Object Start Version
EtherCAT COE and CANopen CANopen	3483h/0	M_01-00-00-000

Fieldbus	Address	Attributes	Signed?
Profinet	2292	DWord	No
sercos® III		8 Octets	

Fieldbus	Index/Subindex	Is 64 bit?	Attributes	Signed?	Object Start Version
Modbus	584	Yes	64 bit	No	M_01-03-00-000

Description

If this value is not equal 0 and the position error PL.ERR (pg 613) is larger than this value, the drive will generate a warning.

If PL.ERRWTHRESH is set to 0 the warning is not issued.

Example

Set position rotary units to 2 degrees. If you set PL.ERRWTHRESH to 100 and the position error is larger than 100 degrees, then the drive will generate a warning.

```
UNIT.PROTARY 2
```

```
PL.ERRWTHRESH 100
```

Related Topics

PL.ERR (pg 613) | PL.ERRFTHRESH (pg 615) | PL.ERRMODE (pg 617)

7.29.6 PL.FB

General Information	
Type	R/O Parameter
Description	Reads the position feedback value.
Units	Depends on UNIT.PLINEAR (pg 716) or UNIT.PROTARY (pg 718) Rotary: counts, rad, deg, (custom units), 16-bit counts Linear: counts, mm, µm, (custom units), 16-bit counts
Range	N/A
Default Value	N/A
Data Type	Float
See Also	FB1.OFFSET
Start Version	M_01-00-00-000

AKD BASIC Information	
Data Type	Integer

Variants Supported

Variant	Supported
AKD Base	Yes
AKD with Position Indexer	Yes
AKD EtherCAT	Yes
AKD CANopen	Yes
AKD BASIC	Yes
AKD SynqNet	Yes
AKD EtherNet/IP	Yes
AKD Profinet	Yes
AKD sercos [®] III	Yes
AKD-N	Yes
AKD-C	No

Fieldbus Information

Fieldbus	Index/Subindex	Object Start Version
EtherCAT COE and CANopen CANopen	6064h/0	M_01-00-00-000

Fieldbus	Address	Attributes	Signed?
Profinet	2294	DWord	Yes
sercos [®] III		8 Octets	

Fieldbus	Index/Subindex	Is 64 bit?	Attributes	Signed?	Object Start Version
Modbus	588	Yes	64 bit	Yes	M_01-03-00-000

Description

PL.FB returns the position feedback value.

AKD BASIC Example

```
Print          PL.FB, MOVE.POSCOMMAND  
MOVE.POSCOMMAND = 0  
Print          PL.FB, MOVE.POSCOMMAND
```

Related Topics

[PL.ERR \(pg 613\)](#) | [PL.ERRFTHRESH \(pg 615\)](#) | [PL.ERRMODE \(pg 617\)](#) | [PL.ERRWTHRESH \(pg 619\)](#)

7.29.7 PL.FBSOURCE

General Information	
Type	NV Parameter
Description	Sets the feedback source for the position loop.
Units	N/A
Range	Range will differ depending on drive model. 0 to 1 (for AKD-x-xxxxx-NAxx-xxxx) 0 to 2 (for AKD-x-xxxxx-NBxx-xxxx)
Default Value	0
Data Type	Integer
Start Version	M_01-00-00-000

Variants Supported

Variant	Supported
AKD Base	Yes
AKD with Position Indexer	Yes
AKD EtherCAT	Yes
AKD CANopen	Yes
AKD BASIC	Yes
AKD SynqNet	Yes
AKD EtherNet/IP	Yes
AKD Profinet	Yes
AKD sercos [®] III	Yes
AKD-N	No
AKD-C	No

Fieldbus Information

Fieldbus	Index/Subindex	Is 64 bit?	Attributes	Signed?	Object Start Version
Modbus	592	No	8 bit	No	M_01-03-00-000

Description

This parameter determines the feedback source that the position loop uses. A value of 0 for this parameter selects the primary feedback, a value of 1 selects the secondary feedback. If you use the secondary feedback as the source for the position loop, then FB2.MODE mode should be set as 0 (A/B signals). A/B signals are the only supported feedback type as secondary feedback into the position loop. Other settings for FB2.MODE are intended as pulse inputs or a gearing command when PL.FBSOURCE remains 0.

0	Primary Feedback connected to X10.
1	Secondary Feedback (DRV.HANDWHEEL) connected to X7 or X9.
2	Tertiary Feedback connected to X9 (only supported with AKD-x-xxxxx-NBxx-xxxx).

Related Topics

PL.ERR (pg 613) | PL.ERRFTHRESH (pg 615) | PL.ERRMODE (pg 617) | PL.ERRWTHRESH (pg 619)

7.29.8 PL.INTINMAX

General Information	
Type	NV Parameter
Description	Limits the input of the position loop integrator by setting the input saturation.
Units	Depends on UNIT.PLINEAR (pg 716) or UNIT.PROTARY (pg 718) Rotary: counts, rad, deg, (custom units), 16-bit counts Linear: counts, mm, μm , (custom units), 16-bit counts
Range	Rotary: 0.000 to 18,446,744,073,709.000 counts 0.000 to 26,986.052 rad 0.000 to 1,546,188.288 deg 0.000 to 21,474.836 (custom units) 0.000 to 281,474,976.710 16-bit counts Linear: 0.000 to 18,446,744,073,709.000 counts 0.000 to 4,294.968*MOTOR.PITCH (pg 570) mm 0.000 to 4,294,967.296*MOTOR.PITCH (pg 570) μm 0.000 to 21,474.836 (custom units) 0.000 to 281,474,976.710 16-bit counts
Default Value	Rotary: 3,999,989,760.000 counts 5.852 rad 335.275 deg 4.657 (custom units) 61,035.000 16-bit counts Linear: 3,999,989,760.000 counts 0MOTOR.PITCH (pg 570) mm 9MOTOR.PITCH (pg 570) μm 4.657 (custom units) 61,035.000 16-bit counts
Data Type	Float
See Also	PL.FB
Start Version	M_01-00-00-000

Variants Supported

Variant	Supported
AKD Base	Yes
AKD with Position Indexer	Yes
AKD EtherCAT	Yes
AKD CANopen	Yes
AKD BASIC	Yes
AKD SynqNet	Yes
AKD EtherNet/IP	Yes

Variant	Supported
AKD Profinet	Yes
AKD sercos [®] III	Yes
AKD-N	Yes
AKD-C	No

Fieldbus Information

Fieldbus	Index/Subindex	Object Start Version
EtherCAT COE and CANopen CANopen	3481h/1	M_01-00-00-000

Fieldbus	Address	Attributes	Signed?
Profinet	2297	DWord	No
sercos [®] III		8 Octets	

Fieldbus	Index/Subindex	Is 64 bit?	Attributes	Signed?	Object Start Version
Modbus	594	Yes	64 bit	No	M_01-03-00-000

Description

PL.INTINMAX limits the input of the position loop integrator by setting the input saturation. When used in concert with PL.INSATOUT, this variable allows you to make the position loop integrator effective near the target position. Far from the target position, however, the integrator is not dominant in the loop dynamics.

Related Topics

PL.ERR (pg 613) | PL.ERRFTHRESH (pg 615) | PL.ERRMODE (pg 617) | PL.ERRWTHRESH (pg 619)

7.29.9 PL.INTOUTMAX

General Information	
Type	NV Parameter
Description	Limits the output of the position loop integrator by setting the output saturation.
Units	Depends on UNIT.PLINEAR (pg 716) or UNIT.PROTARY (pg 718) Rotary: counts, rad, deg, (custom units), 16-bit counts Linear: counts, mm, μm , (custom units), 16-bit counts
Range	Rotary: 0.000 to 18,446,744,073,709.000 counts 0.000 to 26,986.052 rad 0.000 to 1,546,188.288 deg 0.000 to 21,474.836 (custom units) 0.000 to 281,474,976.710 counts 16 bit Linear: 0.000 to 18,446,744,073,709.000 counts 0.000 to 4,294.968*MOTOR.PITCH (pg 570) mm 0.000 to 4,294,967.296*MOTOR.PITCH μm 0.000 to 21,474.836 (custom units) 0.000 to 281,474,976.710 16-bit counts
Default Value	Rotary: 3,999,989,760.000 counts 5.852 rad 335.275 deg 4.657 (custom units) 61,035.000 16-bit counts Linear: 3,999,989,760.000 counts 0MOTOR.PITCH (pg 570) mm 9MOTOR.PITCH (pg 570) μm 4.657 (custom units) 61,035.000 16-bit counts
Data Type	Float
See Also	PL.INTINMAX
Start Version	M_01-00-00-000

Variants Supported

Variant	Supported
AKD Base	Yes
AKD with Position Indexer	Yes
AKD EtherCAT	Yes
AKD CANopen	Yes
AKD BASIC	Yes
AKD SynqNet	Yes
AKD EtherNet/IP	Yes

Variant	Supported
AKD Profinet	Yes
AKD sercos [®] III	Yes
AKD-N	Yes
AKD-C	No

Fieldbus Information

Fieldbus	Index/Subindex	Object Start Version
EtherCAT COE and CANopen CANopen	3481h/2	M_01-00-00-000

Fieldbus	Address	Attributes	Signed?
Profinet	2299	DWord	No
sercos [®] III		8 Octets	

Fieldbus	Index/Subindex	Is 64 bit?	Attributes	Signed?	Object Start Version
Modbus	598	Yes	64 bit	No	M_01-03-00-000

Description

PL.INTOUTMAX limits the output of the position loop integrator by setting the output saturation.

When used in concert with PL.INTINMAX, this variable allows you to make the position loop integrator effective near the target position. Far from the target position, however, the integrator is not dominant in the loop dynamics.

Related Topics

PL.ERR (pg 613) | PL.ERRFTHRESH (pg 615) | PL.ERRMODE (pg 617) | PL.ERRWTHRESH (pg 619)

7.29.10 PL.KI

General Information	
Type	NV Parameter
Description	Sets the integral gain of the position loop.
Units	Hz
Range	0 to 250 Hz
Default Value	0 Hz
Data Type	Float
See Also	PL.KP, PL.KD
Start Version	M_01-00-00-000

Variants Supported

Variant	Supported
AKD Base	Yes
AKD with Position Indexer	Yes
AKD EtherCAT	Yes
AKD CANopen	Yes
AKD BASIC	Yes
AKD SynqNet	Yes
AKD EtherNet/IP	Yes
AKD Profinet	Yes
AKD sercos [®] III	Yes
AKD-N	Yes
AKD-C	No

Fieldbus Information

Fieldbus	Index/Subindex	Object Start Version
EtherCAT COE and CANopen CANopen	3480h/0	M_01-00-00-000

Fieldbus	Address	Attributes	Signed?
Profinet	2301	DWord	No
sercos [®] III		4 Octets	

Fieldbus	Index/Subindex	Is 64 bit?	Attributes	Signed?	Object Start Version
Modbus	602	No	32 bit	No	M_01-03-00-000

Description

PL.KI sets the integral gain of the position regulator PID loop.

Related Topics

PL.ERR (pg 613) | PL.ERRFTHRESH (pg 615) | PL.ERRMODE (pg 617) | PL.ERRWTHRESH (pg 619)

7.29.11 PL.KP

General Information	
Type	NV Parameter
Description	Sets the proportional gain of the position regulator PID loop.
Units	(rev/s)/rev
Range	0 to 2,147,483.008 (rev/s)/rev
Default Value	100 rps/rev
Data Type	Float
See Also	PL.KI (pg 628),
Start Version	M_01-00-00-000

Variants Supported

Variant	Supported
AKD Base	Yes
AKD with Position Indexer	Yes
AKD EtherCAT	Yes
AKD CANopen	Yes
AKD BASIC	Yes
AKD SynqNet	Yes
AKD EtherNet/IP	Yes
AKD Profinet	Yes
AKD sercos [®] III	Yes
AKD-N	Yes
AKD-C	No

Fieldbus Information

Fieldbus	Index/Subindex	Object Start Version
EtherCAT COE and CANopen CANopen	3542h/0	M_01-00-00-000

Fieldbus	Address	Attributes	Signed?
Profinet	2302	DWord	No
sercos [®] III		4 Octets	

Fieldbus	Index/Subindex	Is 64 bit?	Attributes	Signed?	Object Start Version
Modbus	604	No	32 bit	No	M_01-03-00-000

Description

PL.KP sets the proportional gain of the position regulator PID loop.

Related Topics

PL.ERR (pg 613) | PL.ERRFTHRESH (pg 615) | PL.ERRMODE (pg 617) | PL.ERRWTHRESH (pg 619)

7.29.12 PL.MODP1

General Information	
Type	R/W parameter
Description	Sets modulo range parameter.
Units	Depends on UNIT.PROTARY (pg 718) and UNIT.PLINEAR (pg 716)
Range	N/A
Default Value	N/A
Data Type	Float
See Also	N/A
Start Version	M_01-00-00-000

AKD BASIC Information	
Type	R/O
Range	0

Variants Supported

Variant	Supported
AKD Base	Yes
AKD with Position Indexer	Yes
AKD EtherCAT	Yes
AKD CANopen	Yes
AKD BASIC	Yes
AKD SynqNet	Yes
AKD EtherNet/IP	Yes
AKD Profinet	Yes
AKD sercos [®] III	Yes
AKD-N	Yes
AKD-C	No

Fieldbus Information

Fieldbus	Index/Subindex	Object Start Version
EtherCAT COE and CANopen CANopen	3637h/0	M_01-00-00-000

Fieldbus	Address	Attributes	Signed?
Profinet	2303	DWord	Yes
sercos [®] III		8 Octets	

Fieldbus	Index/Subindex	Is 64 bit?	Attributes	Signed?	Object Start Version
Modbus	604	Yes	64 bit	Yes	M_01-03-00-000

Description

This parameter is either the beginning or the end of the modulo range, depending on whether this value is smaller or larger than PL.MODP2. If you set PL.MODP1 equal to PL.MODP2, an error message occurs.

Condition	Beginning of the modulo-range	End of the modulo-range
PL.MODP1 < PL.MODP2	PL.MODP1	PL.MODP2
PL.MODP2 < PL.MODP1	PL.MODP2	PL.MODP1

Related Topics

[PL.ERR \(pg 613\)](#) | [PL.ERRFTHRESH \(pg 615\)](#) | [PL.ERRMODE \(pg 617\)](#) | [PL.ERRWTHRESH \(pg 619\)](#)

7.29.13 PL.MODP2

General Information	
Type	R/W Parameter
Description	Sets the beginning or end modulo range parameter.
Units	Depends on UNIT.PROTARY (pg 718) and UNIT.PLINEAR (pg 716)
Range	N/A
Default Value	N/A
Data Type	Float
See Also	N/A
Start Version	M_01-00-00-000

AKD BASIC Information	
Data Type	Integer

Variants Supported

Variant	Supported
AKD Base	Yes
AKD with Position Indexer	Yes
AKD EtherCAT	Yes
AKD CANopen	Yes
AKD BASIC	Yes
AKD SynqNet	Yes
AKD EtherNet/IP	Yes
AKD Profinet	Yes
AKD sercos [®] III	Yes
AKD-N	Yes
AKD-C	No

Fieldbus Information

Fieldbus	Index/Subindex	Object Start Version
EtherCAT COE and CANopen CANopen	3638h/0	M_01-00-00-000

Fieldbus	Address	Attributes	Signed?
Profinet	2305	DWord	Yes
sercos [®] III		8 Octets	

Fieldbus	Index/Subindex	Is 64 bit?	Attributes	Signed?	Object Start Version
Modbus	610	Yes	64 bit	Yes	M_01-03-00-000

Description

This parameter is either the beginning or the end of the modulo range, depending on whether this value is smaller or larger than PL.MODP1 (pg 630).

Condition	Beginning of the modulo range	End of the modulo range
PL.MODP1 < PL.MODP2	PL.MODP1	PL.MODP2
PL.MODP2 < PL.MODP1	PL.MODP2	PL.MODP1

Related Topics

PL.ERR (pg 613) | PL.ERRFTHRESH (pg 615) | PL.ERRMODE (pg 617) | PL.ERRWTHRESH (pg 619)

7.29.14 PL.MODPDIR

General Information	
Type	R/W Parameter
Description	Sets the direction for absolute motion tasks.
Units	N/A
Range	0 to 2
Default Value	0
Data Type	Integer
See Also	N/A
Start Version	M_01-00-00-000

Variants Supported

Variant	Supported
AKD Base	Yes
AKD with Position Indexer	Yes
AKD EtherCAT	Yes
AKD CANopen	Yes
AKD BASIC	Yes
AKD SynqNet	Yes
AKD EtherNet/IP	Yes
AKD Profinet	Yes
AKD sercos [®] III	Yes
AKD-N	Yes
AKD-C	No

Fieldbus Information

Fieldbus	Index/Subindex	Object Start Version
EtherCAT COE and CANopen CANopen	3430h/0	M_01-00-00-000

Fieldbus	Address	Attributes	Signed?
Profinet	2307	Byte	No
sercos [®] III		2 Octets	

Fieldbus	Index/Subindex	Is 64 bit?	Attributes	Signed?	Object Start Version
Modbus	614	No	8 bit	No	M_01-03-00-000

Description

This parameter defines the direction of an absolute motion task when the modulo position has been activated. For more details about absolute motion tasks, see .. For absolute motion tasks, you can only select a target position within the modulo range.

PL.MODPDIR Settings

Value	Motion	Description
0	Inside Range	The motor moves in a negative direction if the target position of the absolute motion task is less than the current position. The motor moves in positive direction if the target position of the absolute motion task is greater than the current position.
1	Positive	The motor always moves in a positive direction relative to the target position of the absolute motion task.
2	Negative	The motor always moves in a negative direction relative to the target position of the absolute motion task.
3	Shortest Distance	The motor always moves the shortest distance in order to reach the target position within the modulo-range.

7.29.15 PL.MODPEN

General Information	
Type	R/W Parameter
Description	Enables the modulo position.
Units	N/A
Range	0 to 1
Default Value	0
Data Type	Integer
See Also	N/A
Start Version	M_01-00-00-000

Variants Supported

Variant	Supported
AKD Base	Yes
AKD with Position Indexer	Yes
AKD EtherCAT	Yes
AKD CANopen	Yes
AKD BASIC	Yes
AKD SynqNet	Yes
AKD EtherNet/IP	Yes
AKD Profinet	Yes
AKD sercos [®] III	Yes
AKD-N	Yes
AKD-C	No

Fieldbus Information

Fieldbus	Index/Subindex	Object Start Version
EtherCAT COE and CANopen CANopen	35CFh/0	M_01-00-00-000

Fieldbus	Address	Attributes	Signed?
Profinet	2308	Byte	No
sercos [®] III		2 Octets	

Fieldbus	Index/Subindex	Is 64 bit?	Attributes	Signed?	Object Start Version
Modbus	616	No	8 bit	No	M_01-03-00-000

Description

A value of 0 disables the modulo-position and a value of 1 enables the modulo-position feature. The modulo-position feature can be used for circular applications such as round tables.

The position loop of the drive uses always a linear position variable but the data-exchange between the user and the drive uses the modulo-position calculation in order to convert values from linear format into modulo format and vice versa.

The following figure shows the interface between the user and the drive for PL.MODPEN=1:

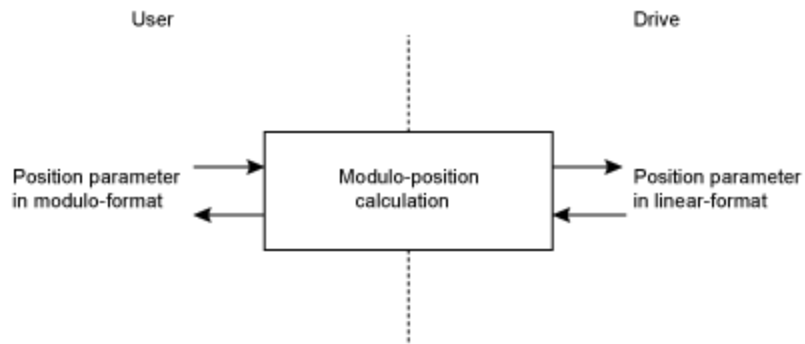

7.30 PLS Parameters

This section describes the PLS parameters.

7.30.1 PLS.EN	639
7.30.2 PLS.MODE	641
7.30.3 PLS.P1 TO PLS.P8	643
7.30.4 PLS.RESET	645
7.30.5 PLS.STATE	647
7.30.6 PLS.T1 TO PLS.T8	649
7.30.7 PLS.UNITS	651
7.30.8 PLS.WIDTH1 TO PLS.WIDTH8	654

7.30.1 PLS.EN

General Information	
Type	R/W Parameter
Description	Enables programmable limit switch (PLS).
Units	N/A
Range	0 to 255
Default Value	0
Data Type	Integer
See Also	PLS.MODE (pg 641), PLS.RESET, PLS.STATE, PLS.UNITS, PLS.P1 to PLS.P8, PLS.WIDTH1 to PLS.WIDTH8, PLS.T1 to PLS.T8
Start Version	M_01-02-03-000

Variants Supported

Variant	Supported
AKD Base	Yes
AKD with Position Indexer	Yes
AKD EtherCAT	Yes
AKD CANopen	Yes
AKD BASIC	Yes
AKD SynqNet	Yes
AKD EtherNet/IP	Yes
AKD Profinet	Yes
AKD sercos® III	Yes
AKD-N	Yes
AKD-C	No

Fieldbus Information

Fieldbus	Index/Subindex	Object Start Version
EtherCAT COE and CANopen CANopen	34A3h/1	M_01-02-03-000

Fieldbus	Address	Attributes	Signed?
Profinet	2309	Word	No
sercos® III		2 Octets	

Fieldbus	Index/Subindex	Is 64 bit?	Attributes	Signed?	Object Start Version
Modbus	618	No	16 bit	No	M_01-03-00-000

Description

PLS.EN is a bit variable which determines the mode of an individual PLS. Eight PLSs are available in the drive.

Example

Bit Value	Behavior
Bit 0 = 0	Disables PLS 1
Bit 0 = 1	Enables PLS 1
Bit 7 = 0	Disables PLS 8
Bit 7 = 1	Enables PLS 8

7.30.2 PLS.MODE

General Information	
Type	R/W Parameter
Description	Selects programmable limit switch mode.
Units	N/A
Range	0 to 255
Default Value	0
Data Type	Integer
See Also	PLS.EN, PLS.RESET, PLS.STATE, PLS.UNITS, PLS.P1 to PLS.P8, PLS.WIDTH1 to PLS.WIDTH8, PLS.T1 to PLS.T8
Start Version	M_01-02-03-000

Variants Supported

Variant	Supported
AKD Base	Yes
AKD with Position Indexer	Yes
AKD EtherCAT	Yes
AKD CANopen	Yes
AKD BASIC	Yes
AKD SynqNet	Yes
AKD EtherNet/IP	Yes
AKD Profinet	Yes
AKD sercos [®] III	Yes
AKD-N	Yes
AKD-C	No

Fieldbus Information

Fieldbus	Index/Subindex	Object Start Version
EtherCAT COE and CANopen CANopen	34A3h/3	M_01-02-03-000

Fieldbus	Address	Attributes	Signed?
Profinet	2310	Word	No
sercos [®] III		2 Octets	

Fieldbus	Index/Subindex	Is 64 bit?	Attributes	Signed?	Object Start Version
Modbus	620	No	16 bit	No	M_01-03-00-000

Description

PLS.MODE is a bit variable which determines the mode of an individual PLS. Eight PLSs are available in the drive.

Example

Bit Value	Behavior
Bit 0 = 0	PLS 1 is monitored continuously.
Bit 0 = 1	PLS 1 is monitored until it is triggered once (single-shot method). The PLS observation can be re-armed using the PLS.RESET command.
Bit 7 = 0	PLS 8 is monitored continuously.
Bit 7 = 1	PLS 8 is monitored until it is triggered once (single-shot method). The PLS observation can be re-armed using the PLS.RESET command.

7.30.3 PLS.P1 TO PLS.P8

General Information	
Type	R/W Parameter
Description	Sets the trigger point for programmable limit switches.
Units	Depends on UNIT.PROTARY (pg 718) or UNIT.PLINEAR (pg 716)
Range	N/A
Default Value	0
Data Type	Float
See Also	UNIT.PROTARY (pg 718)
Start Version	M_01-02-03-000

AKD BASIC Information	
Data Type	Integer

Variants Supported

Variant	Supported
AKD Base	Yes
AKD with Position Indexer	Yes
AKD EtherCAT	Yes
AKD CANopen	Yes
AKD BASIC	Yes
AKD SynqNet	Yes
AKD EtherNet/IP	Yes
AKD Profinet	Yes
AKD sercos [®] III	Yes
AKD-N	Yes
AKD-C	No

Fieldbus Information

Fieldbus	Index/Subindex		Object Start Version
	Index	Subindex	
EtherCAT COE and CANopen CANopen	34A0h/1	PLS.P1	M_01-02-03-000
	34A0h/2	PLS.P2	
	34A0h/3	PLS.P3	
	34A0h/4	PLS.P4	
	34A0h/5	PLS.P5	
	34A0h/6	PLS.P6	
	34A0h/7	PLS.P7	
	34A0h/8	PLS.P8	

Parameter	Fieldbus	Address	Attributes	Signed?
PLS.P1	Profinet	2311	DWord	Yes
	sercos [®] III		8 Octets	
PLS.P2	Profinet	2313	DWord	
	sercos [®] III		8 Octets	
PLS.P3	Profinet	2315	DWord	
	sercos [®] III		8 Octets	
PLS.P4	Profinet	2317	DWord	
	sercos [®] III		8 Octets	
PLS.P5	Profinet	2319	DWord	
	sercos [®] III		8 Octets	
PLS.P6	Profinet	2321	DWord	
	sercos [®] III		8 Octets	
PLS.P7	Profinet	2323	DWord	
	sercos [®] III		8 Octets	
PLS.P8	Profinet	2325	DWord	
	sercos [®] III		8 Octets	

Fieldbus	Index/Subindex	Is 64 bit?	Attributes	Signed?	Object Start Version	
Modbus	622	PLS.P1	Yes	64 bit	Yes	M_01-03-00-000
	626	PLS.P2				
	630	PLS.P3				
	634	PLS.P4				
	638	PLS.P5				
	642	PLS.P6				
	646	PLS.P7				
	650	PLS.P8				

Description

PLS.P1 to PLS.P8 define the trigger point of the PLS. For further information about how these parameters affect PLS behavior, see the PLS.UNITS parameter description.

7.30.4 PLS.RESET

General Information	
Type	R/O Parameter
Description	Resets programmable limit switch.
Units	N/A
Range	0 to 255
Default Value	N/A
Data Type	Integer
See Also	PLS.EN, PLS.MODE, PLS.STATE, PLS.UNITS, PLS.Px (x=1...8), PLS.WIDTHx (x=1...8), PLS.Tx (x=1...8)
Start Version	M_01-02-03-000

Variants Supported

Variant	Supported
AKD Base	Yes
AKD with Position Indexer	Yes
AKD EtherCAT	Yes
AKD CANopen	Yes
AKD BASIC	Yes
AKD SynqNet	Yes
AKD EtherNet/IP	Yes
AKD Profinet	Yes
AKD sercos [®] III	Yes
AKD-N	Yes
AKD-C	No

Fieldbus Information

Fieldbus	Index/Subindex	Object Start Version
EtherCAT COE and CANopen CANopen	34A3h/2	M_01-02-03-000

Fieldbus	Address	Attributes	Signed?
Profinet	2327	Word	No
sercos [®] III		2 Octets	

Fieldbus	Index/Subindex	Is 64 bit?	Attributes	Signed?	Object Start Version
Modbus	654	No	16 bit	No	M_01-03-00-000

Description

This parameter is a bit variable and is used in order to re-arm the corresponding PLS.STATE observation for another single-shot PLS use (see also PLS.MODE).

Example

Bit Value	Behavior
Bit 0 = 0	The PLS 1 observation (PLS.STATE bit 0) is not re-armed.
Bit 0 = 1	The PLS 1 observation (PLS.STATE bit 0) is re-armed.
Bit 7 = 0	The PLS 8 observation (PLS.STATE bit 7) is not re-armed.
Bit 7 = 1	The PLS 8 observation (PLS.STATE bit 7) is re-armed.

7.30.5 PLS.STATE

General Information	
Type	R/O Parameter
Description	Reads the programmable limit switch state.
Units	N/A
Range	N/A
Default Value	N/A
Data Type	Integer
See Also	PLS.EN, PLS.RESET, PLS.UNITS, PLS.MODE, PLS.P1 TO PLS.P8, PLS.WIDTH1 TO PLS.WIDTH8, PLS.T1 TO PLS.T8
Start Version	M_01-02-03-000

Variants Supported

Variant	Supported
AKD Base	Yes
AKD with Position Indexer	Yes
AKD EtherCAT	Yes
AKD CANopen	Yes
AKD BASIC	Yes
AKD SynqNet	Yes
AKD EtherNet/IP	Yes
AKD Profinet	Yes
AKD sercos [®] III	Yes
AKD-N	Yes
AKD-C	No

Fieldbus Information

Fieldbus	Index/Subindex	Object Start Version
EtherCAT COE and CANopen CANopen	34A3h/4	M_01-02-03-000

Fieldbus	Address	Attributes	Signed?
Profinet	2328	Word	No
sercos [®] III		2 Octets	

Fieldbus	Index/Subindex	Is 64 bit?	Attributes	Signed?	Object Start Version
Modbus	656	No	16 bit	No	M_01-03-00-000

Description

This parameter is a bit variable and displays the current status of the individual programmable limit switches.

Example

Bit 0 = 0: Programmable Limit Switch 1 (PLS 1) is not active.

Bit 0 = 1: Programmable Limit Switch 1 (PLS 1) is active.

Bit 7 = 0: Programmable Limit Switch 8 (PLS 8) is not active.

Bit 7 = 1: Programmable Limit Switch 8 (PLS 8) is not active.

7.30.6 PLS.T1 TO PLS.T8

General Information	
Type	R/W parameter
Description	Sets programmable limit switch time
Units	ms
Range	0 to 65,536 ms
Default Value	500 ms
Data Type	Integer
See Also	PLS.EN, PLS.RESET, PLS.STATE, PLS.UNITS, PLS.MODE, PLS.WIDTH1 TO PLS.WIDTH8, PLS.P1 TO PLS.P8
Start Version	M_01-02-03-000

Variants Supported

Variant	Supported
AKD Base	Yes
AKD with Position Indexer	Yes
AKD EtherCAT	Yes
AKD CANopen	Yes
AKD BASIC	Yes
AKD SynqNet	Yes
AKD EtherNet/IP	Yes
AKD Profinet	Yes
AKD sercos [®] III	Yes
AKD-N	Yes
AKD-C	No

Fieldbus Information

Fieldbus	Index/Subindex	Object Start Version
EtherCAT COE and CANopen CANopen	34A2h/1	PLS.T1
	34A2h/2	PLS.T2
	34A2h/3	PLS.T3
	34A2h/4	PLS.T4
	34A2h/5	PLS.T5
	34A2h/6	PLS.T6
	34A2h/7	PLS.T7
	34A2h/8	PLS.T8
		M_01-02-03-000

Parameter	Fieldbus	Address	Attributes	Signed?
PLS.T1	Profinet	2329	Word	No
	sercos [®] III		2 Octets	
PLS.T2	Profinet	2330	Word	
	sercos [®] III		2 Octets	
PLS.T3	Profinet	2331	Word	
	sercos [®] III		2 Octets	
PLS.T4	Profinet	2332	Word	
	sercos [®] III		2 Octets	
PLS.T5	Profinet	2333	Word	
	sercos [®] III		2 Octets	
PLS.T6	Profinet	2334	Word	
	sercos [®] III		2 Octets	
PLS.T7	Profinet	2335	Word	
	sercos [®] III		2 Octets	
PLS.T8	Profinet	2336	Word	
	sercos [®] III		2 Octets	

Fieldbus	Index/Subindex	Is 64 bit?	Attributes	Signed?	Object Start Version	
Modbus	658	PLS.T1	No	16 bit	No	M_01-03-00-000
	660	PLS.T2				
	662	PLS.T3				
	664	PLS.T4				
	666	PLS.T5				
	668	PLS.T6				
	670	PLS.T7				
	672	PLS.T8				

Description

These parameters define the time of the PLS pulse for time-based PLS handling.

For further information about the PLS functionality, especially the meaning of the PLS.T1 to PLS.T8 parameter, refer to the PLS.UNITS parameter.

7.30.7 PLS.UNITS

General Information	
Type	R/W parameter
Description	Sets programmable limit switch (PLS) units.
Units	N/A
Range	0 to 255
Default Value	0
Data Type	Integer
See Also	PLS.EN (pg 639), PLS.RESET (pg 645), PLS.STATE (pg 647), PLS.MODE (pg 641), PLS.P1 TO PLS.P8 (pg 643) PLS.WIDTH1 TO PLS.WIDTH8 (pg 654), PLS.T1 TO PLS.T8 (pg 649)
Start Version	M_01-02-03-000

Variants Supported

Variant	Supported
AKD Base	Yes
AKD with Position Indexer	Yes
AKD EtherCAT	Yes
AKD CANopen	Yes
AKD BASIC	Yes
AKD SynqNet	Yes
AKD EtherNet/IP	Yes
AKD Profinet	Yes
AKD sercos [®] III	Yes
AKD-N	Yes
AKD-C	No

Fieldbus Information

Fieldbus	Index/Subindex	Object Start Version
EtherCAT COE and CANopen CANopen	34A4h/0	M_01-02-03-000

Fieldbus	Address	Attributes	Signed?
Profinet	2337	Byte	No
sercos [®] III		2 Octets	

Fieldbus	Index/Subindex	Is 64 bit?	Attributes	Signed?	Object Start Version
Modbus	674	No	8 bit	No	M_01-03-00-000

Description

PLS.UNITS is a bit variable which determines the behavior of the eight PLSs available in the drive. This parameter is used to select the units for the PLS pulse.

Examples

Bit Value	Behavior
Bit 0 = 0 Position-based PLS handling.	The PLS.STATE parameter displays an active PLS 1 when the position is within the range of PLS.P1 + PLS.WIDTH1 (PLS.P1 <= PL.FB <= PLS.P1+PLS.WIDTH1). When the parameter PLS.WIDTH1 has been set to the value of 0, this bit will be activated as soon as PLS.FB >= PL.P1.
Bit 0 = 1 Time-based PLS handling.	After PLS.P1 is crossed, the PLS.STATE parameter displays an active PLS 1 for a PLS.T1 ms period of time.
Bit 7 = 0 Position-based PLS handling.	The PLS.STATE parameter displays an active PLS 8 when the position is within the range of PLS.P8 + PLS.WIDTH8 (PLS.P8 <= PL.FB <= PLS.P8+PLS.WIDTH8). When the parameter PLS.WIDTH8 has been set to the value of 0, this bit will be activated as soon as PLS.FB >= PL.P8.
Bit 7 = 1 Time-based PLS handling.	After PLS.P8 has been crossed, the PLS.STATE parameter displays an active PLS 8 for a PLS.T8 ms period of time.

Continuous position-based PLS handling

PLS.P1 = 720

PLS.WIDTH1 = 360

PLS.UNITS bit 0 (for PLS 1) = low; PLS.T1 is not considered.

PLS.EN bit 0 (for PLS 1) = high

PLS.MODE bit 0 (for PLS 1) = low

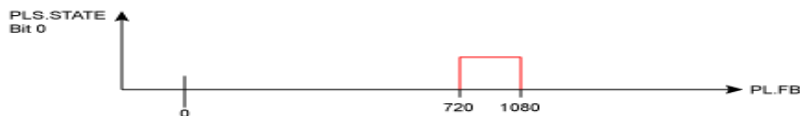

Time-based PLS handling

PLS.P1 = 720

PLS.T1 = 10

PLS.UNITS bit 0 (for PLS 1) = low; PLS.WIDTH1 is not considered.

PLS.EN bit 0 (for PLS 1) = high

PLS.MODE bit 0 (for PLS 1) = low

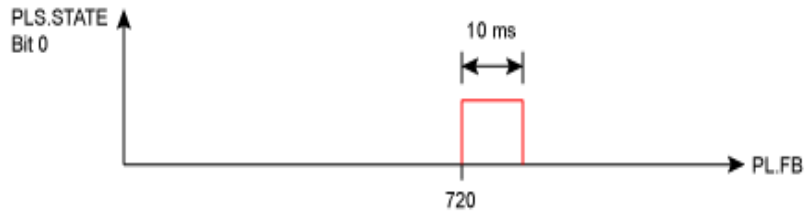

Positive direction of travel

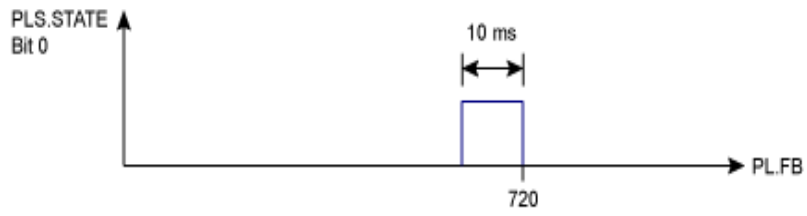

Negative direction of travel

7.30.8 PLS.WIDTH1 TO PLS.WIDTH8

General Information	
Type	R/W parameter
Description	Programmable Limit Switch Width
Units	Depends on UNIT.PROTARY (pg 718) or UNIT.PLINEAR (pg 716)
Range	N/A
Default Value	0
Data Type	Float
See Also	PLS.EN, PLS.RESET, PLS.STATE, PLS.UNITS, PLS.MODE, PLS.P1 TO PLS.P8, PLS.T1 TO PLS.T8
Start Version	M_01-02-03-000

AKD BASIC Information	
Data Type	Integer

Variants Supported

Variant	Supported
AKD Base	Yes
AKD with Position Indexer	Yes
AKD EtherCAT	Yes
AKD CANopen	Yes
AKD BASIC	Yes
AKD SynqNet	Yes
AKD EtherNet/IP	Yes
AKD Profinet	Yes
AKD sercos [®] III	Yes
AKD-N	Yes
AKD-C	No

Fieldbus Information

Fieldbus	Index/Subindex	Object Start Version
EtherCAT COE and CANopen CANopen	34A1h/1	PLS.WIDTH1
	34A1h/2	PLS.WIDTH2
	34A1h/3	PLS.WIDTH3
	34A1h/4	PLS.WIDTH4
	34A1h/5	PLS.WIDTH5
	34A1h/6	PLS.WIDTH6
	34A1h/7	PLS.WIDTH7
	34A1h/8	PLS.WIDTH8
		M_01-02-03-000

Parameter	Fieldbus	Address	Attributes	Signed?
PLS.WIDTH1	Profinet	2338	DWord	Yes
	sercos [®] III		8 Octets	
PLS.WIDTH2	Profinet	2340	DWord	
	sercos [®] III		8 Octets	
PLS.WIDTH3	Profinet	2342	DWord	
	sercos [®] III		8 Octets	
PLS.WIDTH4	Profinet	2344	DWord	
	sercos [®] III		8 Octets	
PLS.WIDTH5	Profinet	2346	DWord	
	sercos [®] III		8 Octets	
PLS.WIDTH6	Profinet	2348	DWord	
	sercos [®] III		8 Octets	
PLS.WIDTH7	Profinet	2350	DWord	
	sercos [®] III		8 Octets	
PLS.WIDTH8	Profinet	2352	DWord	
	sercos [®] III		8 Octets	

Fieldbus	Index/Subindex	Is 64 bit?	Attributes	Signed?	Object Start Version
Modbus	676	Yes	64 bit	Yes	M_01-03-00-000
	680				
	684				
	688				
	692				
	696				
	700				
	704				

Description

These parameter define the width of the PLS pulse for position-based PLS handling. For further information about the PLS functionality, especially the meaning of the PLS.WIDTH1 to PLS.WIDTH8 parameter, refer to the PLS.UNITS parameter.

7.31 REC Parameters

This section describes the REC parameters.

7.31.1 REC.ACTIVE	657
7.31.2 REC.CH1 to REC.CH6	658
7.31.3 REC.DONE	659
7.31.4 REC.GAP	660
7.31.5 REC.NUMPOINTS	661
7.31.6 REC.OFF	662
7.31.7 REC.RECPRMLIST	663
7.31.8 REC.RETRIEVE	664
7.31.9 REC.RETRIEVEDATA	665
7.31.10 REC.RETRIEVEFRMT	667
7.31.11 REC.RETRIEVEHDR	668
7.31.12 REC.RETRIEVESIZE	669
7.31.13 REC.STOPTYPE	670
7.31.14 REC.TRIG	671
7.31.15 REC.TRIGPARAM	672
7.31.16 REC.TRIGPOS	673
7.31.17 REC.TRIGPRMLIST	675
7.31.18 REC.TRIGSLOPE	676
7.31.19 REC.TRIGTYPE	677
7.31.20 REC.TRIGVAL	678

7.31.1 REC.ACTIVE

General Information	
Type	R/O Parameter
Description	Indicates if data recording is in progress (active).
Units	N/A
Range	0 to 1
Default Value	N/A
Data Type	Integer
See Also	REC.DONE (pg 659), REC.OFF (pg 662)
Start Version	M_01-00-00-000

Variants Supported

Variant	Supported
AKD Base	Yes
AKD with Position Indexer	Yes
AKD EtherCAT	Yes
AKD CANopen	Yes
AKD BASIC	Yes
AKD SynqNet	Yes
AKD EtherNet/IP	Yes
AKD Profinet	Yes
AKD sercos [®] III	Yes
AKD-N	Yes
AKD-C	Yes

Fieldbus Information

Fieldbus	Address	Attributes	Signed?
Profinet	2354	Byte	No
sercos [®] III		2 Octets	

Description

REC.ACTIVE indicates whether or not data recording is in progress. Recording is in progress if the trigger was met and the recorder is recording all data.

7.31.2 REC.CH1 to REC.CH6

General Information	
Type	R/W Parameter
Description	Sets recording channels 1 to 6.
Units	N/A
Range	N/A
Default Value	CH1 = IL.FB CH2 = IL.CMD CH3 = VL.FB CH4 = Empty CH5 = Empty CH6 = Empty
Data Type	String
See Also	REC.TRIG (pg 671)
Start Version	M_01-00-00-000

Variants Supported

Variant	Supported
AKD Base	Yes
AKD with Position Indexer	Yes
AKD EtherCAT	Yes
AKD CANopen	Yes
AKD BASIC	Yes
AKD SynqNet	Yes
AKD EtherNet/IP	Yes
AKD Profinet	Yes
AKD sercos [®] III	Yes
AKD-N	Yes
AKD-C	Yes

Description

REC.CHx specifies the recording channels.

There are 3 options to set the recording channels values:

- Set 0, CLR, or CLEAR. This setting clears the recording channel.
- Set one of the recordable commands. The list of recordable commands can be obtain by executing REC.RECPRMLIST (pg 663).
- Set an internal value or variable of the drive (same as for DRV.MEMADDR (pg 359) input).

7.31.3 REC.DONE

General Information	
Type	R/O Parameter
Description	Checks whether or not the recorder has finished recording.
Units	N/A
Range	0 to 1
Default Value	N/A
Data Type	Integer
See Also	REC.ACTIVE, REC.OFF
Start Version	M_01-00-00-000

Variants Supported

Variant	Supported
AKD Base	Yes
AKD with Position Indexer	Yes
AKD EtherCAT	Yes
AKD CANopen	Yes
AKD BASIC	Yes
AKD SynqNet	Yes
AKD EtherNet/IP	Yes
AKD Profinet	Yes
AKD sercos [®] III	Yes
AKD-N	Yes
AKD-C	Yes

Fieldbus Information

Fieldbus	Address	Attributes	Signed?
Profinet	2355	Byte	No
sercos [®] III		2 Octets	

Description

REC.DONE indicates that the recorder has finished recording. This value is reset to 0 when the recorder trigger is set. The drive also resets this value when the recording has finished or when REC.OFF is executed.

7.31.4 REC.GAP

General Information	
Type	R/W Parameter
Description	Specifies the gap between consecutive samples.
Units	N/A
Range	1 to 65,535
Default Value	1
Data Type	Integer
See Also	REC.TRIG (pg 671)
Start Version	M_01-00-00-000

Variants Supported

Variant	Supported
AKD Base	Yes
AKD with Position Indexer	Yes
AKD EtherCAT	Yes
AKD CANopen	Yes
AKD BASIC	Yes
AKD SynqNet	Yes
AKD EtherNet/IP	Yes
AKD Profinet	Yes
AKD sercos [®] III	Yes
AKD-N	Yes
AKD-C	Yes

Fieldbus Information

Fieldbus	Address	Attributes	Signed?
Profinet	2356	Word	No
sercos [®] III		2 Octets	

Description

REC.GAP specifies the gap between consecutive samples. The recording base rate is 16 kHz, thus a gap of 1 means that a sample is recorded every 62.5 μ s.

7.31.5 REC.NUMPOINTS

General Information	
Type	R/W Parameter
Description	Sets the number of points to record.
Units	N/A
Range	1 to 65,535
Default Value	1,000
Data Type	Integer
See Also	REC.TRIG (pg 671)
Start Version	M_01-00-00-000

Variants Supported

Variant	Supported
AKD Base	Yes
AKD with Position Indexer	Yes
AKD EtherCAT	Yes
AKD CANopen	Yes
AKD BASIC	Yes
AKD SynqNet	Yes
AKD EtherNet/IP	Yes
AKD Profinet	Yes
AKD sercos [®] III	Yes
AKD-N	Yes
AKD-C	Yes

Fieldbus Information

Fieldbus	Address	Attributes	Signed?
Profinet	2357	Word	No
sercos [®] III		2 Octets	

Description

REC.NUMPOINTS specifies the number of points (samples) to record.

7.31.6 REC.OFF

General Information	
Type	R/W Parameter
Description	Turns the recorder OFF.
Units	N/A
Range	N/A
Default Value	N/A
Data Type	N/A
See Also	REC.ACTIVE, REC.DONE
Start Version	M_01-00-00-000

Variants Supported

Variant	Supported
AKD Base	Yes
AKD with Position Indexer	Yes
AKD EtherCAT	Yes
AKD CANopen	Yes
AKD BASIC	Yes
AKD SynqNet	Yes
AKD EtherNet/IP	Yes
AKD Profinet	Yes
AKD sercos [®] III	Yes
AKD-N	Yes
AKD-C	Yes

Fieldbus Information

Fieldbus	Address	Attributes	Signed?
Profinet	2358	Command	No
sercos [®] III			

Description

REC.OFF turns the recorder off. In order to set the recorder again, the recorder must first be armed and then a trigger set.

7.31.7 REC.RECPRMLIST

General Information	
Type	R/O Parameter
Description	Reads the list of recordable parameters.
Units	N/A
Range	N/A
Default Value	N/A
Data Type	N/A
See Also	REC.CH1 to REC.CH6 (pg 658)
Start Version	M_01-00-00-000

Variants Supported

Variant	Supported
AKD Base	Yes
AKD with Position Indexer	Yes
AKD EtherCAT	Yes
AKD CANopen	Yes
AKD BASIC	Yes
AKD SynqNet	Yes
AKD EtherNet/IP	Yes
AKD Profinet	Yes
AKD sercos [®] III	Yes
AKD-N	Yes
AKD-C	Yes

Description

This command returns the list of recordable parameters. You can use a recordable parameter as an input to any of the recording channels.

Note that an internal address or a registered variable can be used as input to any of the channels in addition to the list.

7.31.8 REC.RETRIEVE

General Information	
Type	R/O Parameter
Description	Transfers all the recorded data to the communication channel.
Units	N/A
Range	N/A
Default Value	N/A
Data Type	String
See Also	N/A
Start Version	M_01-00-00-000

Variants Supported

Variant	Supported
AKD Base	Yes
AKD with Position Indexer	Yes
AKD EtherCAT	Yes
AKD CANopen	Yes
AKD BASIC	Yes
AKD SynqNet	Yes
AKD EtherNet/IP	Yes
AKD Profinet	Yes
AKD sercos [®] III	Yes
AKD-N	Yes
AKD-C	Yes

Description

REC.RETRIEVE causes the drive to transfer all the recorded data to the communication channel.

Example

The following format is the retrieve reply format (for N samples, G sample gap, and M parameters, where $M \leq 6$):

```
Recording
<N>, <G>
<parameter name 1> ... <parameter name M>
Value11 ... Value1M
Value N1 ... ValueNM
```

7.31.9 REC.RETRIEVEDATA

General Information	
Type	R/W Parameter
Description	Retrieves the recorded data without the header.
Units	N/A
Range	N/A
Default Value	N/A
Data Type	N/A
See Also	REC.RETRIEVE, REC.RETRIEVEHDR, REC.RETRIEVESIZE
Start Version	M_01-00-00-000

Variants Supported

Variant	Supported
AKD Base	Yes
AKD with Position Indexer	Yes
AKD EtherCAT	Yes
AKD CANopen	Yes
AKD BASIC	Yes
AKD SynqNet	Yes
AKD EtherNet/IP	Yes
AKD Profinet	Yes
AKD sercos [®] III	Yes
AKD-N	Yes
AKD-C	Yes

Description

REC.RETRIEVEDATA retrieves a section of recorded data according to REC.RETRIEVESIZE from the received index; if no index is received, the drive retrieves the data from next section. An index is supplied to enable multiple retrieves and to give better control on the buffer in case of overflow. If no index or a negative value is present, then the index is ignored.

WorkBench uses this parameter to retrieve the data continuously for real time recoding.

The size of the data returned by this command depends on the number set by REC.RETRIEVESIZE.

Use REC.RETRIEVE for complete recording information view.

Notes:

- If REC.RETRIEVESIZE is larger than the buffer size, then it simply returns the whole buffer (no error).
- If the index is received, the data will be continuously returned starting from the given index (default starting index is 0).
- If the index is out of the bounds of the buffer, then it will be ignored.
- If recorder is active and REC.STOPTYPE==0, then this parameter returns an error.
- If REC.STOPTYPE==1, then this parameter returns the next section of data in the buffer (even if it reached the end of the buffer, it will return to the beginning of the buffer and add the data from index 0.)

- If REC.STOPTYPE==1 and the retrieve is too slow (gets overrun by the recorder), an overflow error message is returned instead of the retrieved data.
- If REC.STOPTYPE==0 and no index is received, continuously send the sections of data until the end of the buffer is reached. Then, return to the beginning of buffer and continue.
- A new REC.TRIG (pg 671) command automatically sets the index to 0.

Example

The following example retrieves data from index 100 in the size of 10 (hence places 100 to 109 in the buffer)

```
REC.NUMPOINTS 1000  
REC.RETRIVESIZE 10  
REC.TRIG  
REC.RETRIEVEDATA 100
```

7.31.10 REC.RETRIEVEFRMT

General Information	
Type	R/W Parameter
Description	Sets the format for recorded data output.
Units	N/A
Range	0 to 1; 0 = Standard format, 1 = Internal format (high speed)
Default Value	1
Data Type	Integer
See Also	REC.RETRIEVE (pg 664), REC.RETRIEVEDATA (pg 665)
Start Version	M_01-00-00-000

Variants Supported

Variant	Supported
AKD Base	Yes
AKD with Position Indexer	Yes
AKD EtherCAT	Yes
AKD CANopen	Yes
AKD BASIC	Yes
AKD SynqNet	Yes
AKD EtherNet/IP	Yes
AKD Profinet	Yes
AKD sercos [®] III	Yes
AKD-N	Yes
AKD-C	Yes

Description

Recorded data is transferred to the communication channel in one of two formats: standard or internal high speed. The standard (slower) format cannot be used for continuous recording, but is more easily read. The high speed format allows continuous data recording (needed for autotuning). WorkBench supports both formats.

Example

The following recorder data is in standard format:

```
10,1
IL.FB,VL.CMD,VL.FB
-0.086,0.000,2.661
0.000,0.000,3.605
0.029,0.000,-0.486
```

The following recorder data is in internal format:

```
10,1
IL.FB,VL.CMD,VL.FB
F3-0x56,F30x0,F30xA65
F30x0,F30x0,F30xE15
F30x1D,F30x0,F3-0x1E6
```

7.31.11 REC.RETRIEVEHDR

General Information	
Type	R/O Parameter
Description	Retrieves the recorded header without the data.
Units	N/A
Range	N/A
Default Value	N/A
Data Type	N/A
See Also	REC.RETRIEVE, REC.RETRIEVEDATA
Start Version	M_01-00-00-000

Variants Supported

Variant	Supported
AKD Base	Yes
AKD with Position Indexer	Yes
AKD EtherCAT	Yes
AKD CANopen	Yes
AKD BASIC	Yes
AKD SynqNet	Yes
AKD EtherNet/IP	Yes
AKD Profinet	Yes
AKD sercos [®] III	Yes
AKD-N	Yes
AKD-C	Yes

Description

This command retrieves the recorded header without the data of the recording.

WorkBench uses this parameter to retrieve the header once before continuously reading the data for RT recording.

Use REC.RETRIEVE for complete recording information view.

7.31.12 REC.RETRIEVESIZE

General Information	
Type	R/W Parameter
Description	Sets the number of samples that REC.RETRIEVEDATA returns.
Units	recorder samples
Range	0 to 65,535 recorder samples
Default Value	1,000 recorder samples
Data Type	Integer
See Also	REC.RETRIEVEDATA (pg 665), REC.RETRIEVEHDR (pg 668)
Start Version	M_01-00-00-000

Variants Supported

Variant	Supported
AKD Base	Yes
AKD with Position Indexer	Yes
AKD EtherCAT	Yes
AKD CANopen	Yes
AKD BASIC	Yes
AKD SynqNet	Yes
AKD EtherNet/IP	Yes
AKD Profinet	Yes
AKD sercos [®] III	Yes
AKD-N	Yes
AKD-C	Yes

Description

This parameter sets the number of samples that REC.RETRIEVEDATA (pg 665) returns.

WorkBench also uses this parameter to set the number of samples returned when retrieving the data continuously for RT recoding.

Use REC.RETRIEVE (pg 664) for the complete recording information view.

7.31.13 REC.STOPTYPE

General Information	
Type	R/W Parameter
Description	Sets the recorder stop type.
Units	N/A
Range	0 or 1
Default Value	0
Data Type	Integer
Start Version	M_01-00-00-000

Variants Supported

Variant	Supported
AKD Base	Yes
AKD with Position Indexer	Yes
AKD EtherCAT	Yes
AKD CANopen	Yes
AKD BASIC	Yes
AKD SynqNet	Yes
AKD EtherNet/IP	Yes
AKD Profinet	Yes
AKD sercos [®] III	Yes
AKD-N	Yes
AKD-C	Yes

Fieldbus Information

Fieldbus	Address	Attributes	Signed?
Profinet	2359	Byte	No
sercos [®] III		2 Octets	

Description

This parameter sets the stop type for the recording.

0 = Recorder fills in the buffer once.

1 = Recorder runs, continuously filling the recording circular buffer.

To stop RT recording, execute REC.OFF.

7.31.14 REC.TRIG

General Information	
Type	Command
Description	Triggers the recorder.
Units	N/A
Range	N/A
Default Value	N/A
Data Type	N/A
Start Version	M_01-00-00-000

Variants Supported

Variant	Supported
AKD Base	Yes
AKD with Position Indexer	Yes
AKD EtherCAT	Yes
AKD CANopen	Yes
AKD BASIC	Yes
AKD SynqNet	Yes
AKD EtherNet/IP	Yes
AKD Profinet	Yes
AKD sercos [®] III	Yes
AKD-N	Yes
AKD-C	Yes

Fieldbus Information

Fieldbus	Address	Attributes	Signed?
Profinet sercos [®] III	2360	Command	No

Description

REC.TRIG starts the trigger according to the trigger type defined by REC.TRIGTYPE.

REC.TRIG sets the value of REC.DONE to 0.

After calling REC.TRIG, the data that was recorded by previous recording is deleted and cannot be retrieved.

No REC parameters can be set after a call to REC.TRIG until the recorder has finished or until REC.OFF is executed.

7.31.15 REC.TRIGPARAM

General Information	
Type	R/W Parameter
Description	Sets the parameter that triggers the recorder.
Units	N/A
Range	N/A
Default Value	IL.FB
Data Type	String
See Also	REC.TRIG
Start Version	M_01-00-00-000

Variants Supported

Variant	Supported
AKD Base	Yes
AKD with Position Indexer	Yes
AKD EtherCAT	Yes
AKD CANopen	Yes
AKD BASIC	Yes
AKD SynqNet	Yes
AKD EtherNet/IP	Yes
AKD Profinet	Yes
AKD sercos [®] III	Yes
AKD-N	Yes
AKD-C	Yes

Description

REC.TRIGPARAM sets the parameter on which the recorder triggers.

This parameter is only used when REC.TRIGTYPE = 2.

Input values are:

1. One of the set drive parameters list that can be set as a trigger. The available parameters for trigger are: PL.ERR (pg 613), PL.CMD, PL.FB, VL.CMD, VL.FB, IL.CMD, and IL.FB.
2. Internal value or variable of the drive (same as for DRV.MEMADDR input).

7.31.16 REC.TRIGPOS

General Information	
Type	R/W Parameter
Description	Sets the trigger position in the recording buffer.
Units	%
Range	1 to 100%
Default Value	10%
Data Type	Integer
See Also	REC.TRIG (pg 671), REC.NUMPOINTS (pg 661)
Start Version	M_01-00-00-000

Variants Supported

Variant	Supported
AKD Base	Yes
AKD with Position Indexer	Yes
AKD EtherCAT	Yes
AKD CANopen	Yes
AKD BASIC	Yes
AKD SynqNet	Yes
AKD EtherNet/IP	Yes
AKD Profinet	Yes
AKD sercos [®] III	Yes
AKD-N	Yes
AKD-C	Yes

Fieldbus Information

Fieldbus	Address	Attributes	Signed?
Profinet	2361	Byte	No
sercos [®] III		2 Octets	

Description

REC.TRIGPOS sets the trigger position in the recording buffer. The recording buffer size is defined by REC.NUMPOINTS. The input value is a percentage of the buffer (that is, a value of 25 means saving 25% of the buffer data before the trigger occurs and 75% after it occurs). This parameter is only used when REC.TRIGTYPE = 2 or 3.

Trigger Position

Trigger position (REC.TRIGPOS) allows you to collect data that occurs before the trigger occurs. In some instances, you may want to see the conditions prior to the trigger. Trigger position lets you control how much signal is collected before the trigger condition occurred.

Trigger position is specified in units of percent (%). If you specify a trigger position of x% , then x% of the data is before 0 ms in the data time and 100-x% (the rest of the data) is at or greater than 0 ms. In the figure below, the trigger position is set to 25% (REC.TRIGPOS 25).

In the WorkBench scope, the 0 time point is clear. When collecting the data using REC.RETRIEVE or similar commands, the time is not returned, so some caution should be used when the trigger point is important to understand.

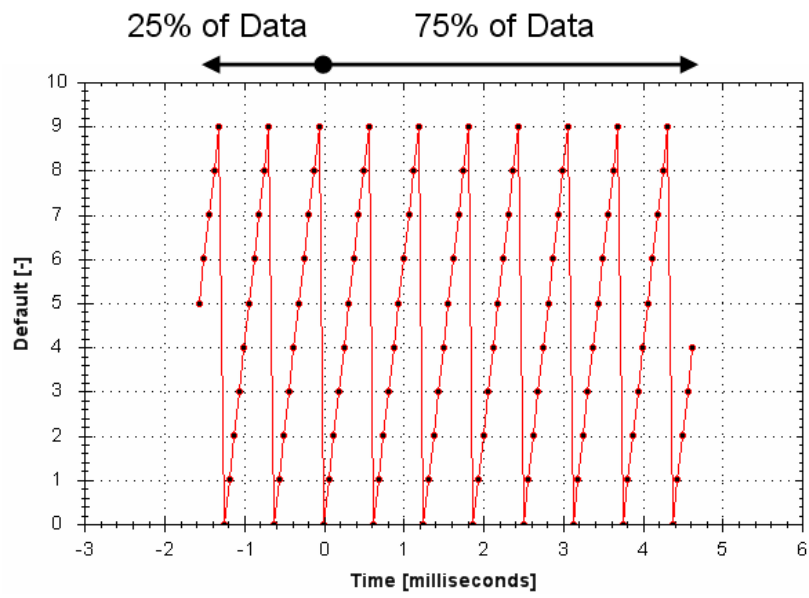

7.31.17 REC.TRIGPRMLIST

General Information	
Type	R/O Parameter
Description	Reads the list of possible trigger parameters.
Units	N/A
Range	N/A
Default Value	N/A
Data Type	N/A
See Also	REC.TRIGPARAM
Start Version	M_01-00-00-000

Variants Supported

Variant	Supported
AKD Base	Yes
AKD with Position Indexer	Yes
AKD EtherCAT	Yes
AKD CANopen	Yes
AKD BASIC	Yes
AKD SynqNet	Yes
AKD EtherNet/IP	Yes
AKD Profinet	Yes
AKD sercos [®] III	Yes
AKD-N	Yes
AKD-C	Yes

Description

This command returns the list of trigger parameters. Each one of those parameters can serve as the trigger parameter (input to REC.TRIGPARAM).

Note that an internal address or a registered variable can be used as input to REC.TRIGPARAM in addition to the list that this parameter returns.

7.31.18 REC.TRIGSLOPE

General Information	
Type	R/W Parameter
Description	Sets the trigger slope.
Units	0 = Negative 1 = Positive
Range	0 to 1
Default Value	0
Data Type	Integer
See Also	REC.TRIG, REC.NUMPOINTS
Start Version	M_01-00-00-000

Variants Supported

Variant	Supported
AKD Base	Yes
AKD with Position Indexer	Yes
AKD EtherCAT	Yes
AKD CANopen	Yes
AKD BASIC	Yes
AKD SynqNet	Yes
AKD EtherNet/IP	Yes
AKD Profinet	Yes
AKD sercos [®] III	Yes
AKD-N	Yes
AKD-C	Yes

Fieldbus Information

Fieldbus	Address	Attributes	Signed?
Profinet	2363	Byte	No
sercos [®] III		2 Octets	

Description

REC.TRIGSLOPE sets the recorder trigger slope. This parameter is only used when REC.TRIGTYPE = 2 or 3.

7.31.19 REC.TRIGTYPE

General Information	
Type	R/W Parameter
Description	Sets the trigger type.
Units	0 = immediate 1 = command 2 = parameter 3 = boolean
Range	0 to 2
Default Value	0
Data Type	Integer
Start Version	M_01-00-00-000

Variants Supported

Variant	Supported
AKD Base	Yes
AKD with Position Indexer	Yes
AKD EtherCAT	Yes
AKD CANopen	Yes
AKD BASIC	Yes
AKD SynqNet	Yes
AKD EtherNet/IP	Yes
AKD Profinet	Yes
AKD sercos [®] III	Yes
AKD-N	Yes
AKD-C	Yes

Fieldbus Information

Fieldbus	Address	Attributes	Signed?
Profinet	2364	Byte	No
sercos [®] III		2 Octets	

Description

REC.TRIGTYPE sets the type of trigger.

Input values are as follows:

Value	Description
0	Recording starts immediately
1	Recording starts on the next command executed through the TCP/IP. The trigger location in the buffer is set according to REC.TRIGPOS.
2	Recording starts per the values of REC.TRIGPARAM, REC.TRIGVAL, REC.TRIGSLOPE, and REC.TRIGPOS.
3	Recording starts when the value of REC.TRIGPARAM is 0 for REC.TRIGSLOPE = 0 or 1 for REC.TRIGSLOPE = 1

7.31.20 REC.TRIGVAL

General Information	
Type	R/W Parameter
Description	Sets the trigger value.
Units	The units of the parameter are chosen according to the unit type.
Range	0 to 2
Default Value	0
Data Type	Integer
Start Version	M_01-00-00-000

Variants Supported

Variant	Supported
AKD Base	Yes
AKD with Position Indexer	Yes
AKD EtherCAT	Yes
AKD CANopen	Yes
AKD BASIC	Yes
AKD SynqNet	Yes
AKD EtherNet/IP	Yes
AKD Profinet	Yes
AKD sercos [®] III	Yes
AKD-N	Yes
AKD-C	Yes

Fieldbus Information

Fieldbus	Address	Attributes	Signed?
Profinet	2365	DWord	Yes
sercos [®] III		8 Octets	

Description

REC.TRIGVAL is the value that must be met by REC.TRIGPARAM for the trigger to occur. The units of this parameter are set according to the units of REC.TRIGPARAM.

7.32 REGEN Parameters

This section describes the REGEN parameters.

7.32.1 REGEN.POWER	680
7.32.2 REGEN.REXT	681
7.32.3 REGEN.TEXT	682
7.32.4 REGEN.TYPE	684
7.32.5 REGEN.WATTEXT	685

7.32.1 REGEN.POWER

General Information	
Type	R/O parameter
Description	Reads regen resistor's calculated power.
Units	Watt
Range	N/A
Default Value	N/A
Data Type	Integer
See Also	N/A
Start Version	M_01-00-00-000

Variants Supported

Variant	Supported
AKD Base	Yes
AKD with Position Indexer	Yes
AKD EtherCAT	Yes
AKD CANopen	Yes
AKD BASIC	Yes
AKD SynqNet	Yes
AKD EtherNet/IP	Yes
AKD Profinet	Yes
AKD sercos [®] III	Yes
AKD-N	No
AKD-C	Yes

Fieldbus Information

Fieldbus	Index/Subindex	Object Start Version
EtherCAT COE and CANopen CANopen	3416h/0	M_01-00-00-000

Fieldbus	Address	Attributes	Signed?
Profinet	2367	DWord	No
sercos [®] III		8 Octets	

Fieldbus	Index/Subindex	Is 64 bit?	Attributes	Signed?	Object Start Version
Modbus	734	Yes	64 bit	No	M_01-03-00-000

Description

This parameter reads regen resistor's calculated power, which is determined as follows:

$$(v^2 / R) * DutyCycle$$

7.32.2 REGEN.REXT

General Information	
Type	NV Parameter
Description	Sets the external, user-defined regen resistor resistance.
Units	Ω
Range	0 to 255 Ω
Default Value	0 Ω
Data Type	Integer
See Also	N/A
Start Version	M_01-00-00-000

Variants Supported

Variant	Supported
AKD Base	Yes
AKD with Position Indexer	Yes
AKD EtherCAT	Yes
AKD CANopen	Yes
AKD BASIC	Yes
AKD SynqNet	Yes
AKD EtherNet/IP	Yes
AKD Profinet	Yes
AKD sercos [®] III	Yes
AKD-N	No
AKD-C	Yes

Fieldbus Information

Fieldbus	Index/Subindex	Object Start Version
EtherCAT COE and CANopen CANopen	35C2h/0	M_01-00-00-000

Fieldbus	Address	Attributes	Signed?
Profinet	2369	Word	No
sercos [®] III		2 Octets	

Fieldbus	Index/Subindex	Is 64 bit?	Attributes	Signed?	Object Start Version
Modbus	738	No	16 bit	No	M_01-03-00-000

Description

REGEN.REXT sets the external user-defined regen resistor resistance. This variable is needed for the regen resistor temperature estimation algorithm.

7.32.3 REGEN.TEXT

General Information	
Type	R/W Parameter
Description	Sets the external regen resistor thermal protection time constant.
Units	Seconds
Range	0.1 to 1,200 Seconds
Default Value	100 Seconds
Data Type	Float
See Also	REGEN.WATTEXT (pg 685), REGEN.REXT (pg 681)
Start Version	M_01-00-00-000

Variants Supported

Variant	Supported
AKD Base	Yes
AKD with Position Indexer	Yes
AKD EtherCAT	Yes
AKD CANopen	Yes
AKD BASIC	Yes
AKD SynqNet	Yes
AKD EtherNet/IP	Yes
AKD Profinet	Yes
AKD sercos [®] III	Yes
AKD-N	No
AKD-C	Yes

Fieldbus Information

Fieldbus	Index/Subindex	Object Start Version
EtherCAT COE and CANopen CANopen	3415h/0	M_01-00-00-000

Fieldbus	Address	Attributes	Signed?
Profinet	2370	DWord	No
sercos [®] III		4 Octets	

Fieldbus	Index/Subindex	Is 64 bit?	Attributes	Signed?	Object Start Version
Modbus	740	No	32 bit	No	M_01-03-00-000

Description

REGEN.TEXT is the time-to-fault when input power steps from 0 to 150% of REGEN.WATTEXT. REGEN.TEXT sets the thermal time constant of the algorithm used to protect the regeneration resistor from overheating and failing. The drive's regen resistor protection algorithm continuously calculates the power dissipated in the resistor and processes that power value through a single pole low pass filter to model the regen resistor's thermal inertia. When the filtered regen power on the output of the filter (REGEN.POWERFILTERED) exceeds REGEN.WATTEXT, a fault occurs. REGEN.TEXT sets the time constant of this thermal inertial filter = (REGEN.TEXT/1.1).

REGEN.TEXT can often be found directly on power resistor data sheets. On the data sheet find the peak overload curve and then find the safe allowed time to be at 150% of the regen resistor's continuous power rating. Set REGEN.TEXT to this value in seconds. Another way regen resistor peak overload capability is often specified is by giving the energy rating in joules of the resistor. If you have the energy rating joule limit E then:

$$\text{REGEN.TEXT} = (1.1) * ((E \text{ in joules}) / \text{REGEN.WATTEXT})$$

Example

The external regen resistor is rated for 250 W continuous, is 33 ohm, and has a joule rating of 500 joules. To use this resistor, the drive settings become:

REGEN.TYPE = -1 (External Regen)

REGEN.REXT = 33

REGEN.WATTEXT = 250

REGEN.TEXT = $(1.1) * (500 \text{ j}) / (250 \text{ W}) = 2.2 \text{ sec}$

7.32.4 REGEN.TYPE

General Information	
Type	NV Parameter
Function	Sets the regen resistor type.
WorkBench Location (Screen/Dialog Box)	Power/Regen Resistor Type
Units	N/A
Range	-1 to 0
Default Value	0
Data Type	Integer
See Also	N/A
Start Version	M_01-00-00-000

Variants Supported

Variant	Supported
AKD Base	Yes
AKD with Position Indexer	Yes
AKD EtherCAT	Yes
AKD CANopen	Yes
AKD BASIC	Yes
AKD SynqNet	Yes
AKD EtherNet/IP	Yes
AKD Profinet	Yes
AKD sercos [®] III	Yes
AKD-N	No
AKD-C	Yes

Fieldbus Information

Fieldbus	Index/Subindex	Is 64 bit?	Attributes	Signed?	Object Start Version
Modbus	742	No	8 bit	Yes	M_01-03-00-000

Description

You can specify a user-defined external regen resistor, select an internal regen resistor, or choose from a list of predefined regen resistors. The values for REGEN.TYPE are shown below:

Type	Description
-1	External user-defined regen resistor
0	Internal regen resistor

If you specify a user-defined regen resistor, then you must also define this resistor's resistance (REGEN.REXT), heatup time (REGEN.REXT), and power (REGEN.WATTEXT).

7.32.5 REGEN.WATTEXT

General Information	
Type	R/W parameter
Description	Sets the regen resistor's power fault level for an external regen resistor.
Units	W
Range	0 to 62,000 W
Default Value	1000 W
Data Type	Integer
See Also	N/A
Start Version	M_01-00-00-000

Variants Supported

Variant	Supported
AKD Base	Yes
AKD with Position Indexer	Yes
AKD EtherCAT	Yes
AKD CANopen	Yes
AKD BASIC	Yes
AKD SynqNet	Yes
AKD EtherNet/IP	Yes
AKD Profinet	Yes
AKD sercos [®] III	Yes
AKD-N	No
AKD-C	Yes

Fieldbus Information

Fieldbus	Index/Subindex	Object Start Version
EtherCAT COE and CANopen CANopen	3414h/0	M_01-00-00-000

Fieldbus	Address	Attributes	Signed?
Profinet	2372	Word	No
sercos [®] III		2 Octets	

Fieldbus	Index/Subindex	Is 64 bit?	Attributes	Signed?	Object Start Version
Modbus	744	No	16 bit	No	M_01-03-00-000

Description

Sets the regen resistor's power fault level for an external regen resistor (when REGEN.TYPE = -1). Above this fault level, the regen resistor's PWM will be 0 and a fault will be issued.

7.33 SD Commands

This section describes commands for SD Card functions.

7.33.1 SD.LOAD	687
7.33.2 SD.SAVE	688
7.33.3 SD.STATUS	689

7.33.1 SD.LOAD

General Information	
Type	Command
Description	Loads the drive state (BASIC program and NV parameters) from the SD card to the AKD (AKDs equipped with IO option card only).
Units	N/A
Range	N/A
Default Value	N/A
Data Type	N/A
Start Version	M_01-06-03-000

Variants Supported

Supported by any AKD with an SD Card slot.

Fieldbus Information

Fieldbus	Index/Subindex	Is 64 bit?	Attributes	Signed?	Object Start Version
Modbus	1684	No	Command	No	M_01-06-03-000

Description

SD.LOAD will load the drive state from the SD card (if one exists) to the AKD. The files loaded to the drive include the BASIC binary file (program.bin) and the NV parameter file (drive.akd). These files must have these exact names or the drive will not recognize them.

Note that this command can only be executed when the drive is in the idle state (i.e. a program is not running) and the drive is disabled.

If a computer is not connected to the drive, the SD.LOAD command can also be issued using the rotary switches S1 and S2.

To load the SD drive state onto the AKD:

1. Set S1 to position 1
2. Set S2 to position 0
3. Hold down the B1 button on the top of the drive for 5 seconds.

NOTE

While the load operation is completing the LED display will flash **Sd**. If an error occurs, the letter E followed by three numbers will flash on the display. See for a description of SD Errors.

7.33.2 SD.SAVE

General Information	
Type	Command
Description	Saves the drive state (BASIC program and NV parameters) to the SD card (AKDs equipped with IO option card only).
Units	N/A
Range	N/A
Default Value	N/A
Data Type	N/A
Start Version	M_01-06-03-000

Variants Supported

Supported by any AKD with an SD Card slot.

Fieldbus Information

Fieldbus	Index/Subindex	Is 64 bit?	Attributes	Signed?	Object Start Version
Modbus	1686	No	Command	No	M_01-06-03-000

Description

SD.SAVE will copy the state of a BASIC drive to the SD card (if one exists). The state of the drive consists of the BASIC binary file and NV parameters. Before an SD.Save is performed, the drive will perform a DRV.NVLOAD and return all of the drive parameters to their NV state. The DRV.NVLOAD is necessary in order to capture the NV parameter states for the parameter file(drive.akd). The files saved to the SD card include the BASIC binary file (program.bin) and the NV parameter file (drive.akd). In order for a drive to recognize and load these files, they must be named program.bin and drive.akd.

NOTE This command can only be executed when the drive is in the idle state (i.e. a program is not running) and the drive is disabled.

If a computer is not connected to the drive, the SD.SAVE command can also be issued using the rotary switches S1 and S2.

To save the drive state onto the SD card using rotary switches:

1. Set S1 to position 1
2. Set S2 to position 1
3. Hold down the B1 button on the top of the drive for 5 seconds.

NOTE While the load operation is completing the LED display will flash **Sd**. If an error occurs, the letter E followed by three numbers will flash on the display. See for a description of SD Errors.

7.33.3 SD.STATUS

General Information	
Type	R/O
Description	Reads the status of the SD card.
Units	N/A
Range	0 to 2
Default Value	0
Data Type	Integer
Start Version	M_01-06-03-000

Variants Supported

Supported by any AKD with an SD Card slot.

Fieldbus Information

Fieldbus	Index/Subindex	Is 64 bit?	Attributes	Signed?	Object Start Version
Modbus	1688	No	8-bit	No	M_01-06-03-000

Description

This parameter reads the status of the SD card.

Status	Description
0	Ready – an SD card is inserted into the drive and you can read and write to it.
1	Read Only – an SD card is inserted into the drive and the write protection tab on the card prohibits writes.
2	Not Inserted – an SD card is not inserted into the drive.

7.34 SM Parameters

This section describes the SM parameters.

7.34.1 SM.I1	691
7.34.2 SM.I2	692
7.34.3 SM.MODE	693
7.34.4 SM.MOVE	696
7.34.5 SM.T1	697
7.34.6 SM.T2	698
7.34.7 SM.V1	699
7.34.8 SM.V2	701

7.34.1 SM.I1

General Information	
Type	NV Parameter
Description	Sets service motion current 1; active in opmode 0 (torque) only.
Units	A
Range	–Drive peak current to +Drive peak current
Default Value	0.025 · Drive peak current
Data Type	Float
See Also	SM.ACCTYPE, SM.I2, SM.MODE, SM.MOVE, SM.T1, SM.T2, SM.V1, SM.V2, SM.VPM1, SM.VPM2
Start Version	M_01-00-00-000

Variants Supported

Variant	Supported
AKD Base	Yes
AKD with Position Indexer	Yes
AKD EtherCAT	Yes
AKD CANopen	Yes
AKD BASIC	Yes
AKD SynqNet	Yes
AKD EtherNet/IP	Yes
AKD Profinet	Yes
AKD sercos [®] III	Yes
AKD-N	Yes
AKD-C	No

Fieldbus Information

Fieldbus	Address	Attributes	Signed?
Profinet	2373	DWord	Yes
sercos [®] III		4 Octets	

Fieldbus	Index/Subindex	Is 64 bit?	Attributes	Signed?	Object Start Version
Modbus	746	No	32 bit	Yes	M_01-03-00-000

Description

SM.I1 defines the current that is used in service motion modes 0 and 1 (see SM.MODE (pg 693)).

7.34.2 SM.I2

General Information	
Type	NV Parameter
Description	Sets service motion current 2; active in opmode 0 (torque) only.
Units	A
Range	–Drive peak current to +Drive peak current
Default Value	0.025 · Drive peak current
Data Type	Float
See Also	SM.ACCTYPE, SM.I1, SM.MODE, SM.MOVE, SM.T1, SM.T2, SM.V1, SM.V2, SM.VPM1, SM.VPM2
Start Version	M_01-00-00-000

Variants Supported

Variant	Supported
AKD Base	Yes
AKD with Position Indexer	Yes
AKD EtherCAT	Yes
AKD CANopen	Yes
AKD BASIC	Yes
AKD SynqNet	Yes
AKD EtherNet/IP	Yes
AKD Profinet	Yes
AKD sercos [®] III	Yes
AKD-N	Yes
AKD-C	No

Fieldbus Information

Fieldbus	Address	Attributes	Signed?
Profinet	2374	DWord	Yes
sercos [®] III		4 Octets	

Fieldbus	Index/Subindex	Is 64 bit?	Attributes	Signed?	Object Start Version
Modbus	748	No	32 bit	Yes	M_01-03-00-000

Description

SM.I2 defines the current that is used in service motion mode 1 (see SM.MODE (pg 693)).

7.34.3 SM.MODE

General Information	
Type	NV Parameter
Description	Sets the service motion mode.
Units	N/A
Range	0 to 2
Default Value	0
Data Type	Integer
See Also	SM.I1 (pg 691), SM.I2 (pg 692), SM.MOVE (pg 696), SM.T1 (pg 697) SM.T2 (pg 698), SM.V1 (pg 699), SM.V2 (pg 701), DRV.ACC (pg 303)DRV.DEC (pg 316)
Start Version	M_01-01-00-000

Variants Supported

Variant	Supported
AKD Base	Yes
AKD with Position Indexer	Yes
AKD EtherCAT	Yes
AKD CANopen	Yes
AKD BASIC	Yes
AKD SynqNet	Yes
AKD EtherNet/IP	Yes
AKD Profinet	Yes
AKD sercos [®] III	Yes
AKD-N	Yes
AKD-C	No

Fieldbus Information

Fieldbus	Address	Attributes	Signed?
Profinet	2375	Word	No
sercos [®] III		2 Octets	

Fieldbus	Index/Subindex	Is 64 bit?	Attributes	Signed?	Object Start Version
Modbus	750	No	16 bit	No	M_01-03-00-000

Description

SM.MODE defines the mode of service motion for each loop. Two types of service motion are available :

- A constant motion in one direction (endless or for a certain amount of time).
- An alternating motion.

The possible modes for this parameter are described in the following table:

SM.MODE	Description	Requirements
0	<p>Constant motion in closed current loop mode of operation.</p> <ul style="list-style-type: none"> • DRV.OPMODE 0: The drive generates a constant current command value (SM.I1) for a certain amount of time (if SM.T1>0) or endless (if SM.T1=0). The drive will not generate any ramps in this mode of operation. • DRV.OPMODE 1 or 2: The drive generates a constant velocity command value (SM.V1) for a certain amount of time (if SM.T1>0) or endless (if SM.T1=0). The drive generates acceleration and deceleration ramps according to the DRV.ACC and DRV.DEC setting in this mode of operation. <p>The service motion can be stopped by using the DRV.STOP command.</p>	<p>DRV.OPMODE = 0,1, or 2 DRV.CMDSOURCE = 0</p>
1	<ul style="list-style-type: none"> • DRV.OPMODE 0: The drive generates a current command value (SM.I1) for a certain amount of time (SM.T1). Afterwards the drive generates a current command value (SM.I2) for another certain amount of time (SM.T2). This sequence is repeated as long as a DRV.STOP command occurs. The drive will not generate any ramps in this mode of operation. • DRV.OPMODE 1 or 2: The drive generates a velocity command value (SM.V1) for a certain amount of time (SM.T1). Afterwards the drive generates a velocity command value (SM.V2) for another certain amount of time (SM.T2). This sequence is repeated as long as a DRV.STOP command occurs. The drive will generate an acceleration and deceleration ramps according to the DRV.ACC and DRV.DEC setting in this mode of operation. 	<p>DRV.OPMODE = 0, 1, or 2 DRV.CMDSOURCE = 0</p>
2	<p>This mode executes the same service motion as mode 0. However, the motion is described by SM.I2, SM.T2 and SM.V2. This enables a change on the fly and is mostly used under fieldbus control.</p>	<p>DRV.OPMODE = 0, 1, or 2 DRV.CMDSOURCE = 0</p>

Ramps

The drive uses DRV.ACC and DRV.DEC for the ramps in DRV.OPMODE 1 (closed velocity) and 2 (closed position). The drive does not generate any ramps in service motion mode 0 and 1.

Service Motion for DRV.OPMODE 0 and SM.MODE 1

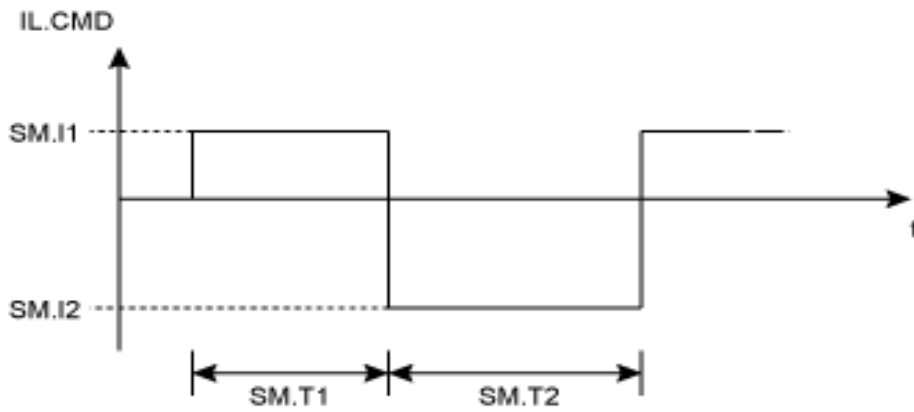

Service motion for DRV.OPMODE 1 or 2 and SM.MODE 1

DRV.OPMODE 1: VL.CMD
 DRV.OPMODE 2: d/dt (PL.CMD)

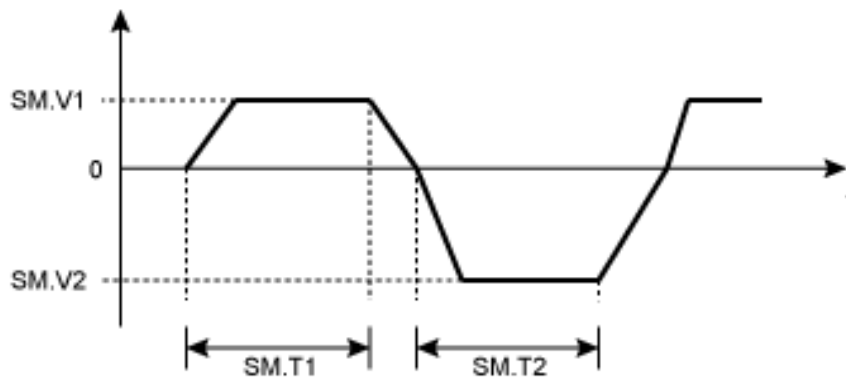

The deceleration process from SM.V1 or SM.V2 to 0 is not included in SM.T1 and SM.T2, respectively. SM.T1 and SM.T2 start as soon as the command value has reached the velocity 0.

7.34.4 SM.MOVE

General Information	
Type	Command
Description	Starts the service motion.
Units	N/A
Range	N/A
Default Value	N/A
Data Type	N/A
See Also	SM.MODE
Start Version	M_01-00-00-000

Variants Supported

Variant	Supported
AKD Base	Yes
AKD with Position Indexer	Yes
AKD EtherCAT	Yes
AKD CANopen	Yes
AKD BASIC	Yes
AKD SynqNet	Yes
AKD EtherNet/IP	Yes
AKD Profinet	Yes
AKD sercos [®] III	Yes
AKD-N	Yes
AKD-C	No

Fieldbus Information

Fieldbus	Address	Attributes	Signed?
Profinet sercos [®] III	2376	Command	No

Fieldbus	Index/Subindex	Is 64 bit?	Attributes	Signed?	Object Start Version
Modbus	752	No	Command	No	M_01-03-00-000

Description

This command starts the service motion that has been selected by the SM.MODE parameter.

7.34.5 SM.T1

General Information	
Type	NV Parameter
Description	Sets the service motion time 1.
Units	ms
Range	0 to 65,535 ms
Default Value	500 ms
Data Type	Integer
See Also	SM.I1, SM.I2, SM.MODE, SM.MOVE, SM.T2, SM.V1, SM.V2, SM.VPM1, SM.VPM2
Start Version	M_01-00-00-000

Variants Supported

Variant	Supported
AKD Base	Yes
AKD with Position Indexer	Yes
AKD EtherCAT	Yes
AKD CANopen	Yes
AKD BASIC	Yes
AKD SynqNet	Yes
AKD EtherNet/IP	Yes
AKD Profinet	Yes
AKD sercos [®] III	Yes
AKD-N	Yes
AKD-C	No

Fieldbus Information

Fieldbus	Address	Attributes	Signed?
Profinet	2377	Word	No
sercos [®] III		2 Octets	

Fieldbus	Index/Subindex	Is 64 bit?	Attributes	Signed?	Object Start Version
Modbus	754	No	16 bit	No	M_01-03-00-000

Description

SM.T1 defines the time of the service motion that is used in all service motion modes (see SM.MODE). For an alternating service motion mode, SM.T1 may not be set to 0.

7.34.6 SM.T2

General Information	
Type	NV Parameter
Description	Sets the service motion time 2.
Units	ms
Range	0 to 65,535 ms
Default Value	500 ms
Data Type	Integer
See Also	SM.I1, SM.I2, SM.MODE, SM.MOVE, SM.T1, SM.V1, SM.V2, SM.VPM1, SM.VPM2
Start Version	M_01-00-00-000

Variants Supported

Variant	Supported
AKD Base	Yes
AKD with Position Indexer	Yes
AKD EtherCAT	Yes
AKD CANopen	Yes
AKD BASIC	Yes
AKD SynqNet	Yes
AKD EtherNet/IP	Yes
AKD Profinet	Yes
AKD sercos [®] III	Yes
AKD-N	Yes
AKD-C	No

Fieldbus Information

Fieldbus	Address	Attributes	Signed?
Profinet	2378	Word	No
sercos [®] III		2 Octets	

Fieldbus	Index/Subindex	Is 64 bit?	Attributes	Signed?	Object Start Version
Modbus	756	No	16 bit	No	M_01-03-00-000

Description

SM.T2 defines the time of the service motion that is used in service motion modes 1, 3, and 5 (see SM.MODE).

7.34.7 SM.V1

General Information	
Type	NV Parameter
Description	Sets service motion velocity 1; active in opmode 1 (velocity) and 2 (position).
Units	Depends on UNIT.ACCROTARY (pg 713) or UNIT.ACCLINEAR (pg 712) Rotary: rpm, rps, deg/s, custom units/s, rad/s Linear: Counts/s, mm/s, μ m/s, custom units/s
Range	Rotary: -15,000.000 to 15,000.000 rpm -250.000 to 250.000 rps -90,000.000 to 90,000.000 deg/s -1,250.000 to 1,250.000 custom units/s -1,570.796 to 1,570.796 rad/s Linear: -1,073,741,824,000.000 to 1,073,741,824,000.000 counts/s -250.000*MOTOR.PITCH (pg 570) to 250.000*MOTOR.PITCH (pg 570) mm/s -250,000.000*MOTOR.PITCH (pg 570) to 250,000.000*MOTOR.PITCH (pg 570) μ m/s -1,250.000 to 1,250.000 custom units/s
Default Value	Rotary: 60.000 rpm 1.000 rps 359.999 deg/s 5.000 custom units/s 6.283 rad/s Linear: 0.001 Counts/s 1.000*MOTOR.PITCH (pg 570) mm/s 999.998*MOTOR.PITCH (pg 570) μ m/sec 5.000 custom units/s
Data Type	Float
See Also	SM.I1, SM.I2, SM.MODE, SM.MOVE, SM.T1, SM.T2, SM.V2
Start Version	M_01-00-00-000

Variants Supported

Variant	Supported
AKD Base	Yes
AKD with Position Indexer	Yes
AKD EtherCAT	Yes
AKD CANopen	Yes
AKD BASIC	Yes
AKD SynqNet	Yes
AKD EtherNet/IP	Yes
AKD Profinet	Yes

Variant	Supported
AKD sercos [®] III	Yes
AKD-N	Yes
AKD-C	No

Fieldbus Information

Fieldbus	Parameter	Address	Attributes	Signed?
Profinet	SM.V1_32	2379	DWord	Yes
sercos [®] III			8 Octets	

Fieldbus	Index/Subindex	Is 64 bit?	Attributes	Signed?	Object Start Version
Modbus	758	Yes	Low 32 bit word	Yes	M_01-03-00-000

Description

SM.V1 defines the velocity that is used in service motion modes 0 and 1 (see SM.MODE (pg 693)) in the closed velocity and position mode of operation.

7.34.8 SM.V2

General Information	
Type	NV Parameter
Description	Sets service motion velocity 2; active in opmode 1 (velocity) and 2 (position).
Units	Depends on UNIT.ACCROTARY (pg 713) or UNIT.ACCLINEAR (pg 712) Rotary: rpm, rps, deg/s, custom units/s, rad/s Linear: counts/s, mm/s, μ m/s, custom units/s
Range	Rotary: -15,000.000 to 15,000.000 rpm -250.000 to 250.000 rps -90,000.000 to 90,000.000 deg/s -1,250.000 to 1,250.000 custom units/s -1,570.796 to 1,570.796 rad/s Linear: -1,073,741,824,000.000 to 1,073,741,824,000.000 counts/s -250.000*MOTOR.PITCH (pg 570) to 250.000*MOTOR.PITCH (pg 570) mm/s -250,000.000*MOTOR.PITCH (pg 570) to 250,000.000*MOTOR.PITCH (pg 570) μ m/s -1,250.000 to 1,250.000 custom units/s
Default Value	Rotary: -60.000 rpm -1.000 rps -359.999 deg/s -5.000 custom units/s -6.283 rad/s Linear: -0.001 counts/s -1.000*MOTOR.PITCH (pg 570) mm/s -999.998*MOTOR.PITCH (pg 570) μ m/sec -5.000 custom units/s
Data Type	Float
See Also	SM.I1, SM.I2, SM.MODE, SM.MOVE, SM.T1, SM.T2, SM.V1
Start Version	M_01-00-00-000

Variants Supported

Variant	Supported
AKD Base	Yes
AKD with Position Indexer	Yes
AKD EtherCAT	Yes
AKD CANopen	Yes
AKD BASIC	Yes
AKD SynqNet	Yes
AKD EtherNet/IP	Yes
AKD Profinet	Yes
AKD sercos [®] III	Yes

Variant	Supported
AKD-N	Yes
AKD-C	No

Fieldbus Information

Fieldbus	Parameter	Address	Attributes	Signed?
Profinet	SM.V2_32	2380	DWord	Yes
sercos [®] III			8 Octets	

Fieldbus	Index/Subindex	Is 64 bit?	Attributes	Signed?	Object Start Version
Modbus	760	Yes	Low 32 bit word	Yes	M_01-03-00-000

Description

SM.V2 defines the velocity that is used in service motion mode 1 (see SM.MODE) in the closed velocity and position mode of operation.

7.35 STO Parameters

This section describes the STO parameters.

7.35.1 STO.STATE	704
-------------------------------	------------

7.35.1 STO.STATE

General Information	
Type	R/O Parameter
Description	Returns the status of the safe torque off.
Units	N/A
Range	0 to 1
Default Value	N/A
Data Type	Integer
See Also	N/A
Start Version	M_01-00-00-000

Variants Supported

Variant	Supported
AKD Base	Yes
AKD with Position Indexer	Yes
AKD EtherCAT	Yes
AKD CANopen	Yes
AKD BASIC	Yes
AKD SynqNet	Yes
AKD EtherNet/IP	Yes
AKD Profinet	Yes
AKD sercos [®] III	Yes
AKD-N	Yes
AKD-C	No

Fieldbus Information

Fieldbus	Address	Attributes	Signed?
Profinet	2381	Byte	No
sercos [®] III		2 Octets	

Fieldbus	Index/Subindex	Is 64 bit?	Attributes	Signed?	Object Start Version
Modbus	762	No	8 bit	No	M_01-03-00-000

Description

STO.STATE returns the status of the safe torque off.

- 1 - Safe torque on (no safe torque off fault).
- 0 - Safe torque off (safe torque off fault).

7.36 SWLS Parameters

This section describes the SWLS parameters.

7.36.1 SWLS.EN	706
7.36.2 SWLS.LIMIT0	708
7.36.3 SWLS.LIMIT1	709
7.36.4 SWLS.STATE	710

7.36.1 SWLS.EN

General Information	
Type	NV Parameter
Description	Enables and disables software travel limit switches.
Units	N/A
Range	0 to 3
Default Value	0
Data Type	U8
See Also	7.13.47 DRV.MOTIONSTAT
Start Version	M_01-00-00-000

Variants Supported

Variant	Supported
AKD Base	Yes
AKD with Position Indexer	Yes
AKD EtherCAT	Yes
AKD CANopen	Yes
AKD BASIC	Yes
AKD SynqNet	Yes
AKD EtherNet/IP	Yes
AKD Profinet	Yes
AKD sercos [®] III	Yes
AKD-N	Yes
AKD-C	No

Fieldbus Information

Fieldbus	Address	Attributes	Signed?
Profinet	2382	Word	No
sercos [®] III		2 Octets	

Fieldbus	Index/Subindex	Is 64 bit?	Attributes	Signed?	Object Start Version
Modbus	764	No	16 bit	No	M_01-03-00-000

Description

This parameter enables the software travel limit switches. The software limit switches are only active if the axis is homed.

Value	Description
0	Disables both limit switches.
1	Enables limit switch 0.
2	Enables limit switch 1.
3	Enables limit switch 0 and limit switch 1.

If SWLS.EN = 3, then whichever limit switch is set to a greater value will be used as the upper limit switch. For all other values of SWLS.EN, use SWLS.LIMIT0 for the lower limit switch, and SWLS.LIMIT1 for the upper limit switch.

Example

Bit 0 = 0: Disable SWLS.LIMIT0

Bit 0 = 1: Enable SWLS.LIMIT0

Bit 1 = 0: Disable SWLS.LIMIT1

Bit 1 = 1: Enable SWLS.LIMIT1

7.36.2 SWLS.LIMIT0

General Information	
Type	NV Parameter
Description	Sets the position of the software travel limit switch 0.
Units	Position units
Range	-9,007,199,254,740,992 to 9,007,199,254,740,991
Default Value	0
Data Type	S64
Start Version	M_01-00-00-000

Variants Supported

Variant	Supported
AKD Base	Yes
AKD with Position Indexer	Yes
AKD EtherCAT	Yes
AKD CANopen	Yes
AKD BASIC	Yes
AKD SynqNet	Yes
AKD EtherNet/IP	Yes
AKD Profinet	Yes
AKD sercos [®] III	Yes
AKD-N	Yes
AKD-C	No

Fieldbus Information

Fieldbus	Index/Subindex	Is 64 bit?	Attributes	Signed?	Object Start Version
Modbus	766	Yes	64 bit	Yes	M_01-03-00-000

Description

This parameter sets the compare register for the software limit switch 0. This value can be either the lower or the upper software limit switch register, depending on the configuration of the software limit switches:

- If only one limit switch is enabled (SWLS.EN = 1 or 2), then SWLS.LIMIT0 is the lower limit, and SWLS.LIMIT1 is the upper limit.
- If both limit switches are enabled (SWLS.EN = 3), then whichever switch is set to a larger value is the upper limit switch. The other switch becomes the lower limit switch.

These switches can be used in addition to hardware limit switches. The software limit switches are only active if the axis is homed. For more information about homing, please refer to the HOME Parameters and DRV.MOTIONSTAT.

7.36.3 SWLS.LIMIT1

General Information	
Type	NV Parameter
Description	Sets the position of the software travel limit switch 0.
Units	Position units
Range	-9,007,199,254,740,992 to 9,007,199,254,740,991
Default Value	1,048,576.000 counts, 16-bit (firmware versions M_01-02-00-000 and above) 68,719,476,736 counts (for firmware version M_01-01-00-000)
Data Type	S64
Start Version	M_01-00-00-000

Variants Supported

Variant	Supported
AKD Base	Yes
AKD with Position Indexer	Yes
AKD EtherCAT	Yes
AKD CANopen	Yes
AKD BASIC	Yes
AKD SynqNet	Yes
AKD EtherNet/IP	Yes
AKD Profinet	Yes
AKD sercos [®] III	Yes
AKD-N	Yes
AKD-C	No

Fieldbus Information

Fieldbus	Index/Subindex	Is 64 bit?	Attributes	Signed?	Object Start Version
Modbus	770	Yes	64 bit	Yes	M_01-03-00-000

Description

This parameter sets the compare register for the software limit switch 1. This value can be either the lower or the upper software limit switch register, depending on the configuration of the software limit switches:

- If only one limit switch is enabled (SWLS.EN = 1 or 2), then SWLS.LIMIT0 is the lower limit, and SWLS.LIMIT1 is the upper limit.
- If both limit switches are enabled (SWLS.EN = 3), then whichever switch is set to a larger value is the upper limit switch. The other switch becomes the lower limit switch.

These switches can be used in addition to hardware limit switches. The software limit switches are only active if the axis is homed. For more information about homing, please refer to the HOME Parameters and DRV.MOTIONSTAT.

7.36.4 SWLS.STATE

General Information	
Type	R/O Parameter
Description	Reads the actual status of software limit switches.
Units	N/A
Range	0 to 3
Default Value	0
Data Type	U8
Start Version	M_01-00-00-000

Variants Supported

Variant	Supported
AKD Base	Yes
AKD with Position Indexer	Yes
AKD EtherCAT	Yes
AKD CANopen	Yes
AKD BASIC	Yes
AKD SynqNet	Yes
AKD EtherNet/IP	Yes
AKD Profinet	Yes
AKD sercos [®] III	Yes
AKD-N	Yes
AKD-C	No

Fieldbus Information

Fieldbus	Address	Attributes	Signed?
Profinet	2387	Word	No
sercos [®] III		2 Octets	

Fieldbus	Index/Subindex	Is 64 bit?	Attributes	Signed?	Object Start Version
Modbus	774	No	16 bit	No	M_01-03-00-000

Description

This parameter reads the status word of the software limit switches. The status word indicates the result of the compare between the software limit switch compare register and the actual position of the position loop.

Example

Bit 0 = 0: SWLS.LIMIT0 (pg 708) is not active.

Bit 0 = 1: SWLS.LIMIT0 is active.

Bit 1 = 0: SWLS.LIMIT1 (pg 709) is not active.

Bit 1 = 1: SWLS.LIMIT1 is active.

Bits 2 to 7 are currently not in use.

7.37 UNIT Parameters

This section describes the UNIT parameters.

7.37.1 UNIT.ACCLINEAR	712
7.37.2 UNIT.ACCROTARY	713
7.37.3 UNIT.LABEL	714
7.37.4 UNIT.PIN	715
7.37.5 UNIT.PLINEAR	716
7.37.6 UNIT.POUT	717
7.37.7 UNIT.PROTARY	718
7.37.8 UNIT.VLINEAR	719
7.37.9 UNIT.VROTARY	720

7.37.1 UNIT.ACCLINEAR

General Information	
Type	NV Parameter
Description	Sets the linear acceleration/deceleration units.
Units	N/A
Range	0 to 3
Default Value	0
Data Type	Integer
See Also	DRV.ACC (pg 303), DRV.DEC (pg 316), MOTOR.TYPE (pg 581)
Start Version	M_01-00-00-000

Variants Supported

Variant	Supported
AKD Base	Yes
AKD with Position Indexer	Yes
AKD EtherCAT	Yes
AKD CANopen	Yes
AKD BASIC	Yes
AKD SynqNet	Yes
AKD EtherNet/IP	Yes
AKD Profinet	Yes
AKD sercos [®] III	Yes
AKD-N	Yes
AKD-C	No

Fieldbus Information

Fieldbus	Address	Attributes	Signed?
Profinet	2388	Byte	No
sercos [®] III		2 Octets	

Fieldbus	Index/Subindex	Is 64 bit?	Attributes	Signed?	Object Start Version
Modbus	776	No	8 bit	No	M_01-03-00-000

Description

UNIT.ACCLINEAR sets the units type for the acceleration and deceleration parameters, when the motor type (MOTOR.TYPE (pg 581)) is linear.

Type	Description
0	[Custom Units]/s ²
1	millimeters per second squared (mm/s ²)
2	micrometers per second squared (µm/s ²)
3	Feedback counts/s ²

7.37.2 UNIT.ACCROTARY

General Information	
Type	NV Parameter
Description	Sets the rotary acceleration/deceleration units.
Units	rpm/s, rps/s, deg/s ² , [Custom Units]/s ²
Range	0 to 3 rpm/s
Default Value	0 rpm/s
Data Type	Integer
See Also	DRV.ACC (pg 303), MOTOR.TYPE (pg 581)
Start Version	M_01-00-00-000

Variants Supported

Variant	Supported
AKD Base	Yes
AKD with Position Indexer	Yes
AKD EtherCAT	Yes
AKD CANopen	Yes
AKD BASIC	Yes
AKD SynqNet	Yes
AKD EtherNet/IP	Yes
AKD Profinet	Yes
AKD sercos [®] III	Yes
AKD-N	Yes
AKD-C	No

Fieldbus Information

Fieldbus	Index/Subindex	Is 64 bit?	Attributes	Signed?	Object Start Version
Modbus	778	No	8 bit	No	M_01-03-00-000

Description

UNIT.ACCROTARY sets the acceleration/deceleration units when the motor type (MOTOR.TYPE (pg 581)) is rotary.

Type	Description
0	rpm/s
1	rps/s
2	deg/s ²
3	(Custom Units) /s ²

7.37.3 UNIT.LABEL

General Information	
Type	NV Parameter
Description	Sets user-defined name for user-defined position units.
Units	N/A
Range	Maximum 16 characters, no spaces
Default Value	Custom Units
Data Type	String
See Also	UNIT.PLINEAR (pg 716), UNIT.POUT (pg 717)
Start Version	M_01-00-00-000

Variants Supported

Variant	Supported
AKD Base	Yes
AKD with Position Indexer	Yes
AKD EtherCAT	Yes
AKD CANopen	Yes
AKD BASIC	Yes
AKD SynqNet	Yes
AKD EtherNet/IP	Yes
AKD Profinet	Yes
AKD sercos [®] III	Yes
AKD-N	Yes
AKD-C	No

Description

If you define a special position unit with UNIT.PLINEAR (pg 716) and UNIT.POUT (pg 717), then you can give this unit a descriptive name. You can name the unit anything you wish, as long as the name is limited to 16 characters and includes no spaces. The label used for velocity and acceleration are in terms of this descriptive name.

This parameter is descriptive only and does not influence drive internal functions in any way.

7.37.4 UNIT.PIN

General Information	
Type	NV Parameter
Description	Sets gear IN for the unit conversion.
Units	User units
Range	0 to 4,294,967,295
Default Value	100
Data Type	Integer
Start Version	M_01-00-00-000

Variants Supported

Variant	Supported
AKD Base	Yes
AKD with Position Indexer	Yes
AKD EtherCAT	Yes
AKD CANopen	Yes
AKD BASIC	Yes
AKD SynqNet	Yes
AKD EtherNet/IP	Yes
AKD Profinet	Yes
AKD sercos [®] III	Yes
AKD-N	Yes
AKD-C	No

Fieldbus Information

Fieldbus	Index/Subindex	Object Start Version
EtherCAT COE and CANopen CANopen	35CAh/0 6092h/1	M_01-00-00-000

Fieldbus	Address	Attributes	Signed?
Profinet	2390	Dword	No
sercos [®] III		4 Octets	

Fieldbus	Index/Subindex	Is 64 bit?	Attributes	Signed?	Object Start Version
Modbus	780	No	32 bit	No	M_01-03-00-000

Description

UNIT.PIN is used in conjunction with UNIT.POUT (pg 717) to set application specific units. This parameter is used as follows in the drive unit conversion:

- For position, this parameter sets the units as [Custom Units]/rev.
- For velocity, this parameter sets the units as [Custom Units]/s.
- For acceleration/deceleration, this parameter sets the units as [Custom Units]/s².

7.37.5 UNIT.PLINEAR

General Information	
Type	NV Parameter
Description	Sets the linear position units.
Units	N/A
Range	0 to 4
Default Value	0
Data Type	Integer
See Also	PL.FB (pg 621), PL.CMD (pg 612), MOTOR.TYPE (pg 581)
Start Version	M_01-00-00-000

Variants Supported

Variant	Supported
AKD Base	Yes
AKD with Position Indexer	Yes
AKD EtherCAT	Yes
AKD CANopen	Yes
AKD BASIC	Yes
AKD SynqNet	Yes
AKD EtherNet/IP	Yes
AKD Profinet	Yes
AKD sercos [®] III	Yes
AKD-N	Yes
AKD-C	No

Fieldbus Information

Fieldbus	Index/Subindex	Is 64 bit?	Attributes	Signed?	Object Start Version
Modbus	782	No	8 bit	No	M_01-03-00-000

Description

UNIT.PLINEAR sets the units type for the position parameters when the motor type (MOTOR.TYPE) is linear.

Type	Description
0	32-bit counts
1	Millimeters (mm)
2	Micrometers (µm)
3	(PIN/POUT) per revolution
4	16-bit counts

7.37.6 UNIT.POUT

General Information	
Type	NV Parameter
Description	Sets gear out for the unit conversion.
Units	User units.
Range	0 to 4,294,967,295
Default Value	20
Data Type	Integer
See Also	UNIT.PLINEAR (pg 716)
Start Version	M_01-00-00-000

Variants Supported

Variant	Supported
AKD Base	Yes
AKD with Position Indexer	Yes
AKD EtherCAT	Yes
AKD CANopen	Yes
AKD BASIC	Yes
AKD SynqNet	Yes
AKD EtherNet/IP	Yes
AKD Profinet	Yes
AKD sercos [®] III	Yes
AKD-N	Yes
AKD-C	No

Fieldbus Information

Fieldbus	Index/Subindex	Is 64 bit?	Attributes	Signed?	Object Start Version
Modbus	784	No	32 bit	No	M_01-03-00-000

Description

UNIT.POUT is used with UNIT.PIN (pg 715) to set application specific units in UNIT.POUT. This parameter is used as follows in the drive unit conversion:

- For position, this parameter sets the units as [Custom Units]/rev.
- For velocity, this parameter sets the units as [Custom Units]/s.
- For acceleration/deceleration, this parameter sets the units as [Custom Units]/s².

7.37.7 UNIT.PROTARY

General Information	
Type	NV Parameter
Description	Sets the position units when the motor type (MOTOR.TYPE (pg 581)) is rotary.
Units	counts, rad, deg, Custom Units, 16-bit counts
Range	0 to 4
Default Value	4 16-bit counts (for firmware versions M_01-02-00-000 and above) 0 counts (for firmware version M_01-01-00-000)
Data Type	Integer
See Also	PL.FB (pg 621), PL.CMD (pg 612), MOTOR.TYPE (pg 581)
Start Version	M_01-00-00-000

Variants Supported

Variant	Supported
AKD Base	Yes
AKD with Position Indexer	Yes
AKD EtherCAT	Yes
AKD CANopen	Yes
AKD BASIC	Yes
AKD SynqNet	Yes
AKD EtherNet/IP	Yes
AKD Profinet	Yes
AKD sercos [®] III	Yes
AKD-N	Yes
AKD-C	No

Fieldbus Information

Fieldbus	Index/Subindex	Is 64 bit?	Attributes	Signed?	Object Start Version
Modbus	786	No	8 bit	No	M_01-03-00-000

Description

UNIT.PROTARY sets the position units when the motor type (MOTOR.TYPE (pg 581)) is rotary.

Value	Units
0	counts
1	radians
2	degrees
3	Custom Units
4	16-bit counts

7.37.8 UNIT.VLINEAR

General Information	
Type	NV Parameter
Description	Sets the linear velocity units.
Units	N/A
Range	0 to 3
Default Value	0
Data Type	Integer
See Also	VL.FB (pg 747), VL.CMDU (pg 744), VL.CMD (pg 743), MOTOR.TYPE (pg 581)
Start Version	M_01-00-00-000

Variants Supported

Variant	Supported
AKD Base	Yes
AKD with Position Indexer	Yes
AKD EtherCAT	Yes
AKD CANopen	Yes
AKD BASIC	Yes
AKD SynqNet	Yes
AKD EtherNet/IP	Yes
AKD Profinet	Yes
AKD sercos [®] III	Yes
AKD-N	Yes
AKD-C	No

Fieldbus Information

Fieldbus	Address	Attributes	Signed?
Profinet	2394	Byte	No
sercos [®] III		2 Octets	

Fieldbus	Index/Subindex	Is 64 bit?	Attributes	Signed?	Object Start Version
Modbus	788	No	8 bit	No	M_01-03-00-000

Description

UNIT.VLINEAR sets the units type for the velocity parameters when the motor type (MOTOR.TYPE (pg 581)) is linear.

Type	Description
0	(Custom Units) per second
1	Micrometers per second
2	Millimeters per second
3	Counts per second

7.37.9 UNIT.VROTARY

General Information	
Type	NV Parameter
Description	Sets the velocity units when the motor type (MOTOR.TYPE (pg 581)) is rotary.
Units	rpm, rps, deg/s, (Custom Units)/s
Range	0 to 3
Default Value	0 rpm
Data Type	Integer
See Also	VL.FB (pg 747), VL.CMDU (pg 744), VL.CMD (pg 743), MOTOR.TYPE (pg 581)
Start Version	M_01-00-00-000

Variants Supported

Variant	Supported
AKD Base	Yes
AKD with Position Indexer	Yes
AKD EtherCAT	Yes
AKD CANopen	Yes
AKD BASIC	Yes
AKD SynqNet	Yes
AKD EtherNet/IP	Yes
AKD Profinet	Yes
AKD sercos [®] III	Yes
AKD-N	Yes
AKD-C	No

Fieldbus Information

Fieldbus	Index/Subindex	Is 64 bit?	Attributes	Signed?	Object Start Version
Modbus	790	No	8 bit	No	M_01-03-00-000

Description

UNIT.VROTARY sets the velocity units when the motor type (MOTOR.TYPE) is rotary.

Value	Units
0	rpm
1	rps
2	deg/s
3	(Custom Units) /s

7.38 VBUS Parameters

This section describes the VBUS parameters.

7.38.1 VBUS.HALFVOLT	722
7.38.2 VBUS.OVFTHRESH	724
7.38.3 VBUS.OVWTHRESH	725
7.38.4 VBUS.RMSLIMIT	726
7.38.5 VBUS.UVFTHRESH	727
7.38.6 VBUS.UVMODE	728
7.38.7 VBUS.UVWTHRESH	729
7.38.8 VBUS.VALUE	730

7.38.1 VBUS.HALFVOLT

General Information	
Type	NV Parameter
Description	Changes voltage thresholds for HV and MV Drives
Units	N/A
Range	0 to 1
Default Value	0
Data Type	Integer
See Also	N/A
Start Version	M_01-04-01-000

Variants Supported

Variant	Supported
AKD Base	Yes
AKD with Position Indexer	Yes
AKD EtherCAT	Yes
AKD CANopen	Yes
AKD BASIC	Yes
AKD SynqNet	Yes
AKD EtherNet/IP	Yes
AKD Profinet	Yes
AKD sercos [®] III	Yes
AKD-N	Yes
AKD-C	Yes

Fieldbus Information

Fieldbus	Address	Attributes	Signed?
Profinet	2609	Byte	No
sercos [®] III		2 Octets	

Fieldbus	Index/Subindex	Is 64 bit?	Attributes	Signed?
Modbus	1218	No	8 bit	No

Description

This parameter is used in order to change some specific voltage thresholds in order to allow HV (high voltage) drives working with MV (medium voltage) thresholds and to allow MV (medium voltage) drives working with LV (low voltage) thresholds.

When the VBUS.HALFVOLT value is changed, the revised thresholds take effect immediately.

The VBUS.HALFVOLT only affects HV and MV drives.

Value	Description
0	The original voltage thresholds are used for the functions mentioned below.
1	Setting the parameter to 1 on a HV Drive causes the AKD to use the voltage thresholds of an MV drive for the functions mentioned below. Setting the parameter to 1 on a MV drive causes the AKD to use the voltage thresholds of a LV drive for the functions mentioned below.

This parameter has an impact on the following voltage-thresholds:

1. DC-bus over-voltage threshold (see VBUS.OVFTHRESH (pg 724)).
2. The regen-resistor enable/disable voltage thresholds.
3. The inrush-relay enable/disable voltage thresholds.

NOTE

The DC-bus under voltage fault threshold (see VBUS.UVFTHRESH (pg 727)) is a user selectable command. It means that the user is responsible for setting the under voltage threshold to a proper value in case that the AKD is supplied with a lower DC-bus voltage than the rated voltage.

7.38.2 VBUS.OVFTHRESH

General Information	
Type	R/O Parameter
Description	Reads the over voltage fault level.
Units	VDC
Range	0 to 900 VDC
Default Value	N/A
Data Type	Integer
See Also	VBUS.UVFTHRESH
Start Version	M_01-00-00-000

Variants Supported

Variant	Supported
AKD Base	Yes
AKD with Position Indexer	Yes
AKD EtherCAT	Yes
AKD CANopen	Yes
AKD BASIC	Yes
AKD SynqNet	Yes
AKD EtherNet/IP	Yes
AKD Profinet	Yes
AKD sercos [®] III	Yes
AKD-N	Yes
AKD-C	Yes

Fieldbus Information

Fieldbus	Address	Attributes	Signed?
Profinet	2397	Word	No
sercos [®] III		2 Octets	

Fieldbus	Index/Subindex	Is 64 bit?	Attributes	Signed?	Object Start Version
Modbus	794	No	16 bit	No	M_01-03-00-000

Description

VBUS.OVFTHRESH reads the over voltage fault level for the DC bus.

This value is read from the drive EEPROM and varies according to the drive type.

7.38.3 VBUS.OVWTHRESH

General Information	
Type	NV Parameter
Description	Sets voltage level for over voltage warning.
Units	VDC
Range	0 to 900 VDC
Default Value	0 VDC (warning disabled)
Data Type	U16
See Also	N/A
Start Version	M_01-00-00-000

Variants Supported

Variant	Supported
AKD Base	Yes
AKD with Position Indexer	Yes
AKD EtherCAT	Yes
AKD CANopen	Yes
AKD BASIC	Yes
AKD SynqNet	Yes
AKD EtherNet/IP	Yes
AKD Profinet	Yes
AKD sercos [®] III	Yes
AKD-N	Yes
AKD-C	Yes

Fieldbus Information

Fieldbus	Address	Attributes	Signed?
Profinet	2398	Word	No
sercos [®] III		2 Octets	

Fieldbus	Index/Subindex	Is 64 bit?	Attributes	Signed?	Object Start Version
Modbus	796	No	16 bit	No	M_01-03-00-000

Description

If VBUS.VALUE value exceeds VBUS.OVWTHRESH, then a warning is generated.

7.38.4 VBUS.RMSLIMIT

General Information	
Type	R/O Parameter
Description	Reads the limit for the bus capacitors load.
Units	Vrms
Range	N/A
Default Value	N/A
Data Type	Integer
See Also	N/A
Start Version	M_01-00-00-000

Variants Supported

Variant	Supported
AKD Base	Yes
AKD with Position Indexer	Yes
AKD EtherCAT	Yes
AKD CANopen	Yes
AKD BASIC	Yes
AKD SynqNet	Yes
AKD EtherNet/IP	Yes
AKD Profinet	Yes
AKD sercos [®] III	Yes
AKD-N	Yes
AKD-C	Yes

Fieldbus Information

Fieldbus	Address	Attributes	Signed?
Profinet	2399	Byte	No
sercos [®] III		2 Octets	

Fieldbus	Index/Subindex	Is 64 bit?	Attributes	Signed?	Object Start Version
Modbus	798	No	8 bit	No	M_01-03-00-000

Description

This parameter reads the limit of the bus capacitor load. When the bus capacitor loads exceeds this limit, the drive generates fault F503.

Excessive bus capacitor load may indicate a disconnected main supply phase.

7.38.5 VBUS.UVFTHRESH

General Information	
Type	R/W Parameter
Description	Sets the under voltage fault level.
Units	VDC
Range	90 to 420 VDC
Default Value	90 VDC
Data Type	Integer
See Also	VBUS.OVFTHRESH
Start Version	M_01-00-00-000

Variants Supported

Variant	Supported
AKD Base	Yes
AKD with Position Indexer	Yes
AKD EtherCAT	Yes
AKD CANopen	Yes
AKD BASIC	Yes
AKD SynqNet	Yes
AKD EtherNet/IP	Yes
AKD Profinet	Yes
AKD sercos [®] III	Yes
AKD-N	Yes
AKD-C	No

Fieldbus Information

Fieldbus	Address	Attributes	Signed?
Profinet	2400	Word	No
sercos [®] III		2 Octets	

Fieldbus	Index/Subindex	Is 64 bit?	Attributes	Signed?	Object Start Version
Modbus	800	No	16 bit	No	M_01-03-00-000

Description

VBUS.UVFTHRESH sets the undervoltage fault level of the DC bus.

The default value is read from the EEPROM, but can be modified by the user and stored on the NV RAM.

This value varies according to drive type.

7.38.6 VBUS.UVMODE

General Information	
Type	N/V Parameter
Description	Indicates undervoltage (UV) mode.
Units	N/A
Range	0 to 1
Default Value	1
Data Type	Integer
See Also	N/A
Start Version	M_01-00-00-000

Variants Supported

Variant	Supported
AKD Base	Yes
AKD with Position Indexer	Yes
AKD EtherCAT	Yes
AKD CANopen	Yes
AKD BASIC	Yes
AKD SynqNet	Yes
AKD EtherNet/IP	Yes
AKD Profinet	Yes
AKD sercos [®] III	Yes
AKD-N	Yes
AKD-C	No

Fieldbus Information

Fieldbus	Address	Attributes	Signed?
Profinet	2401	Byte	No
sercos [®] III		2 Octets	

Fieldbus	Index/Subindex	Is 64 bit?	Attributes	Signed?	Object Start Version
Modbus	802	No	8 bit	No	M_01-03-00-000

Description

This parameter indicates undervoltage (UV) mode.

When VBUS.UVMODE = 0, an undervoltage fault is issued whenever the DC bus goes below the undervoltage threshold.

When VBUS.UVMODE = 1, an undervoltage fault is issued whenever the DC bus goes below the undervoltage threshold and the controller attempts to enable the drive (software or hardware enable).

7.38.7 VBUS.UVWTHRESH

General Information	
Type	NV Parameter
Description	Sets voltage level for undervoltage warning.
Units	VDC
Range	0 to 900 VDC
Default Value	10 volts above the default value of the under voltage fault threshold (VBUS.UVFTHRESH). The default value of VBUS.UVFTHRESH is hardware dependent.
Data Type	U16
See Also	VBUS.UVFTHRESH (pg 727)
Start Version	M_01-00-00-000

Variants Supported

Variant	Supported
AKD Base	Yes
AKD with Position Indexer	Yes
AKD EtherCAT	Yes
AKD CANopen	Yes
AKD BASIC	Yes
AKD SynqNet	Yes
AKD EtherNet/IP	Yes
AKD Profinet	Yes
AKD sercos [®] III	Yes
AKD-N	Yes
AKD-C	No

Fieldbus Information

Fieldbus	Address	Attributes	Signed?
Profinet	2402	Word	No
sercos [®] III		2 Octets	

Fieldbus	Index/Subindex	Is 64 bit?	Attributes	Signed?	Object Start Version
Modbus	804	No	16 bit	No	M_01-03-00-000

Description

If VBUS.VALUE value drops below VBUS.UVWTHRESH, then a warning is generated.

7.38.8 VBUS.VALUE

General Information	
Type	R/O Parameter
Description	Reads DC bus voltage.
Units	VDC
Range	0 to 900 VDC
Default Value	N/A
Data Type	Float
See Also	N/A
Start Version	M_01-00-00-000

Variants Supported

Variant	Supported
AKD Base	Yes
AKD with Position Indexer	Yes
AKD EtherCAT	Yes
AKD CANopen	Yes
AKD BASIC	Yes
AKD SynqNet	Yes
AKD EtherNet/IP	Yes
AKD Profinet	Yes
AKD sercos [®] III	Yes
AKD-N	Yes
AKD-C	Yes

Fieldbus Information

Fieldbus	Index/Subindex	Object Start Version
EtherCAT COE and CANopen CANopen	361Ah/0	M_01-00-00-000

Fieldbus	Address	Attributes	Signed?
Profinet	2403	DWord	Yes
sercos [®] III		4 Octets	

Fieldbus	Index/Subindex	Is 64 bit?	Attributes	Signed?	Object Start Version
Modbus	806	No	32 bit	No	M_01-03-00-000

Description

VBUS.VALUE reads the DC bus voltage.

7.39 VL Parameters

This section describes the VL parameters.

7.39.1 VL.ARPF1 TO VL.ARPF4	732
7.39.2 VL.ARPQ1 TO VL.ARPQ4	734
7.39.3 VL.ARTYPE1 TO VL.ARTYPE4	736
7.39.4 VL.ARZF1 TO VL.ARZF4	738
7.39.5 VL.ARZQ1 TO VL.ARZQ4	740
7.39.6 VL.BUSFF	742
7.39.7 VL.CMD	743
7.39.8 VL.CMDU	744
7.39.9 VL.ERR	746
7.39.10 VL.FB	747
7.39.11 VL.FBFILTER	748
7.39.12 VL.FBSOURCE	749
7.39.13 VL.FBUNFILTERED	750
7.39.14 VL.FF	751
7.39.15 VL.GENMODE	752
7.39.16 VL.KBUSFF	753
7.39.17 VL.KI	754
7.39.18 VL.KO	756
7.39.19 VL.KP	757
7.39.20 VL.KVFF	759
7.39.21 VL.LIMITN	760
7.39.22 VL.LIMITP	762
7.39.23 VL.LMJR	764
7.39.24 VL.MODEL	765
7.39.25 VL.OBSBW	766
7.39.26 VL.OBSMODE	767
7.39.27 VL.THRESH	768
7.39.28 VL.VFTHRESH	770

7.39.1 VL.ARPF1 TO VL.ARPF4

General Information	
Type	R/W Parameter
Description	Sets the natural frequency of the pole (denominator) of anti-resonance (AR) filters 1, 2, 3, and 4; active in opmodes 1 (velocity) and 2 (position) only.
Units	Hz
Range	5 to 5,000 Hz
Default Value	500 Hz
Data Type	Float
See Also	VL.ARPQ1 TO VL.ARPQ4 (pg 734), VL.ARZF1 TO VL.ARZF4 (pg 738), Sets the Q of the zero (numerator) of anti-resonance filter #1; active in opmodes 1 (velocity) and 2 (position) only. (pg 740)
Start Version	M_01-02-00-000

Variants Supported

Variant	Supported
AKD Base	Yes
AKD with Position Indexer	Yes
AKD EtherCAT	Yes
AKD CANopen	Yes
AKD BASIC	Yes
AKD SynqNet	Yes
AKD EtherNet/IP	Yes
AKD Profinet	Yes
AKD sercos [®] III	Yes
AKD-N	Yes
AKD-C	No

Fieldbus Information

Fieldbus	Index/Subindex	Object Start Version
EtherCAT COE and CANopen CANopen	3406h/1	VL.ARPF1
	3406h/2	VL.ARPF2
	3406h/3	VL.ARPF3
	3406h/4	VL.ARPF4
		M_01-02-00-000

Parameter	Fieldbus	Address	Attributes	Signed?
VL.ARPF1	Profinet	2404	DWord	No
	sercos [®] III		4 Octets	
VL.ARPF2	Profinet	2405	DWord	
	sercos [®] III		4 Octets	
VL.ARPF3	Profinet	2406	DWord	
	sercos [®] III		4 Octets	
VL.ARPF4	Profinet	2407	DWord	
	sercos [®] III		4 Octets	

Fieldbus	Index/Subindex		Is 64 bit?	Attributes	Signed?	Object Start Version
Modbus	808	VL.ARPF1	No	32 bit	No	M_01-03-00-000
	810	VL.ARPF2				
	812	VL.ARPF3				
	814	VL.ARPF4				

Description

VL.ARPF1 sets the natural frequency of the pole (denominator) of AR filter 1. This value is F_p in the approximate transfer function of the filter:

$$ARx(s) = [s^2 / (2\pi F_z)^2 + s / (Q_z 2\pi F_z) + 1] / [s^2 / (2\pi F_p)^2 + s / (Q_p 2\pi F_p) + 1]$$

The following block diagram describes the AR filter function; note that AR1 and AR2 are in the forward path, while AR3 and AR4 are applied to feedback:

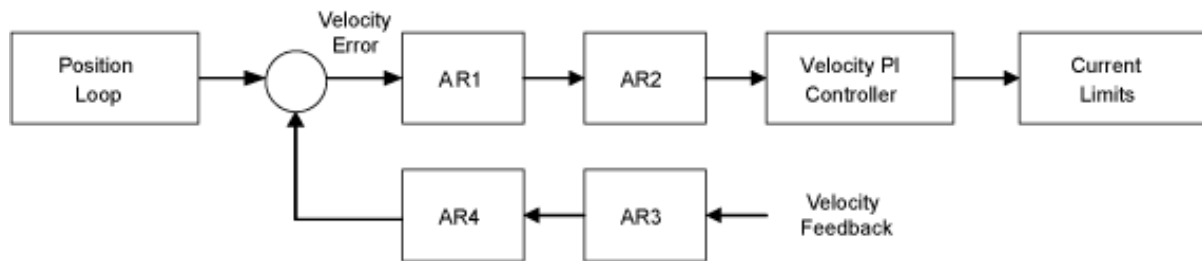

AR1, AR2, AR3, and AR4 are used in velocity and position mode, but are disabled in torque mode.

Discrete time transfer function (applies to all AR filters)

The velocity loop compensation is actually implemented as a digital discrete time system function on the DSP. The continuous time transfer function is converted to the discrete time domain by a backward Euler mapping:

$$s \approx (1-z^{-1})/t, \text{ where } t = 62.5 \mu s$$

The poles are prewarped to F_p and the zeros are prewarped to F_z .

7.39.2 VL.ARPQ1 TO VL.ARPQ4

General Information	
Type	R/W Parameter
Description	Sets the Q of the pole (denominator) of anti-resonance (AR) filter 1; active in opmodes 1 (velocity) and 2 (position) only.
Units	None
Range	0.2 to 20
Default Value	0.5
Data Type	Float
See Also	VL.ARPF1 TO VL.ARPF4 (pg 732), VL.ARZF1 TO VL.ARZF4 (pg 738), VL.ARZQ1 TO VL.ARZQ4 (pg 740)
Start Version	M_01-02-00-000

Variants Supported

Variant	Supported
AKD Base	Yes
AKD with Position Indexer	Yes
AKD EtherCAT	Yes
AKD CANopen	Yes
AKD BASIC	Yes
AKD SynqNet	Yes
AKD EtherNet/IP	Yes
AKD Profinet	Yes
AKD sercos [®] III	Yes
AKD-N	Yes
AKD-C	No

Fieldbus Information

Fieldbus	Index/Subindex	Object Start Version
EtherCAT COE and CANopen CANopen	3406h/5 VL.ARPQ1	M_01-02-00-000
	3406h/6 VL.ARPQ2	
	3406h/7 VL.ARPQ3	
	3406h/8 VL.ARPQ4	

Parameter	Fieldbus	Address	Attributes	Signed?
VL.ARPQ1	Profinet	2408	DWord	No
	sercos [®] III		4 Octets	
VL.ARPQ2	Profinet	2409	DWord	
	sercos [®] III		4 Octets	
VL.ARPQ3	Profinet	2410	DWord	
	sercos [®] III		4 Octets	
VL.ARPQ4	Profinet	2411	DWord	
	sercos [®] III		4 Octets	

Fieldbus	Index/Subindex		Is 64 bit?	Attributes	Signed?	Object Start Version
Modbus	816	VL.ARPQ1	No	32 bit	No	M_01-03-00-000
	818	VL.ARPQ2				
	820	VL.ARPQ3				
	822	VL.ARPQ4				

Description

VL.ARPQ1 sets the Q (quality factor) of the pole (denominator) of AR filter 1. This value is Q_p in the approximate transfer function of the filter:

$$AR_x(s) = [s^2 / (2\pi F_z)^2 + s / (Q_z 2\pi F_z) + 1] / [s^2 / (2\pi F_p)^2 + s / (Q_p 2\pi F_p) + 1]$$

The following block diagram describes the AR filter function; note that AR1 and AR2 are in the forward path, while AR3 and AR4 are applied to feedback:

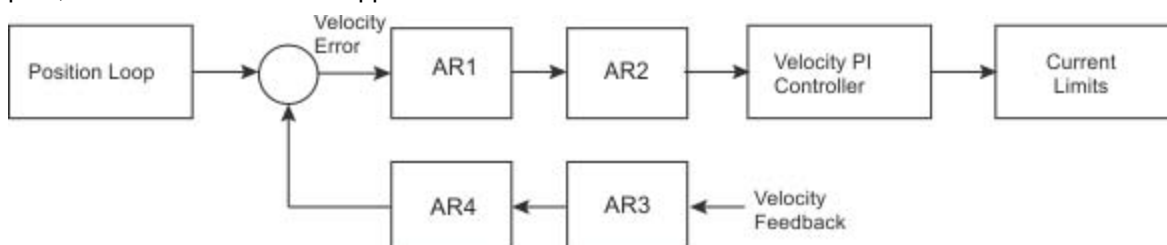

AR1, AR2, AR3, and AR4 are used in velocity and position mode, but are disabled in torque mode.

Discrete time transfer function (applies to all AR filters)

The velocity loop compensation is actually implemented as a digital discrete time system function on the DSP. The continuous time transfer function is converted to the discrete time domain by a backward Euler mapping:

$$s \approx (1-z^{-1})/t, \text{ where } t = 62.5 \mu\text{s}$$

The poles are prewarped to F_p and the zeros are prewarped to F_z .

7.39.3 VL.ARTYPE1 TO VL.ARTYPE4

General Information	
Type	NV Parameter
Description	Indicates the method used to calculate BiQuad coefficients; active in opmodes 1 (velocity) and 2 (position) only.
Units	N/A
Range	0
Default Value	0
Data Type	U8
See Also	N/A
Start Version	M_01-00-00-000

Variants Supported

Variant	Supported
AKD Base	Yes
AKD with Position Indexer	Yes
AKD EtherCAT	Yes
AKD CANopen	Yes
AKD BASIC	Yes
AKD SynqNet	Yes
AKD EtherNet/IP	Yes
AKD Profinet	Yes
AKD sercos [®] III	Yes
AKD-N	Yes
AKD-C	No

Fieldbus Information

Fieldbus	Index/Subindex		Object Start Version
EtherCAT COE and CANopen CANopen	3405h /1	VL.ARTYPE1	M_01-02-00-000
	3405h /2	VL.ARTYPE2	
	3405h /3	VL.ARTYPE3	
	3405h /4	VL.ARTYPE4	

Parameter	Fieldbus	Address	Attributes	Signed?
VL.ARTYPE1	Profinet	2412	Byte	No
	sercos [®] III		2 Octets	
VL.ARTYPE2	Profinet	2413	Byte	
	sercos [®] III		2 Octets	
VL.ARTYPE3	Profinet	2414	Byte	
	sercos [®] III		2 Octets	
VL.ARTYPE4	Profinet	2415	Byte	
	sercos [®] III		2 Octets	

Fieldbus	Index/Subindex		Is 64 bit?	Attributes	Signed?	Object Start Version
Modbus	824	VL.ARTYPE1	No	8 bit	No	M_01-03-00-000
	826	VL.ARTYPE2				
	828	VL.ARTYPE3				
	830	VL.ARTYPE4				

Description

These parameters indicate the method used to calculate the biquad coefficients VL.ARPFx, VL.ARPQx, VL.ARZFx, and VL.ARZQx. A value of 0 indicates that the coefficients are set directly. This parameter has no effect on the filter itself, but is only used to determine the original design parameters. Currently, only the value of 0 is supported.

7.39.4 VL.ARZF1 TO VL.ARZF4

General Information	
Type	R/W Parameter
Description	Sets the natural frequency of the zero (numerator) of anti-resonance (AR)filter 1; active in opmodes 1 (velocity) and 2 (position) only.
Units	Hz
Range	5 to 5,000 Hz
Default Value	500 Hz
Data Type	Float
See Also	VL.ARPF1 TO VL.ARPF4 (pg 732), VL.ARPQ1 TO VL.ARPQ4 (pg 734), VL.ARZQ1 TO VL.ARZQ4 (pg 740)
Start Version	M_01-02-00-000

Variants Supported

Variant	Supported
AKD Base	Yes
AKD with Position Indexer	Yes
AKD EtherCAT	Yes
AKD CANopen	Yes
AKD BASIC	Yes
AKD SynqNet	Yes
AKD EtherNet/IP	Yes
AKD Profinet	Yes
AKD sercos [®] III	Yes
AKD-N	Yes
AKD-C	No

Fieldbus Information

Fieldbus	Index/Subindex	Object Start Version
EtherCAT COE and CANopen CANopen	3406h/9	VL.ARZF1
	3406h/A	VL.ARZF2
	3406h/B	VL.ARZF3
	3406h/C	VL.ARZF4
		M_01-02-00-000

Parameter	Fieldbus	Address	Attributes	Signed?
VL.ARZF1	Profinet	2416	DWord	No
	sercos [®] III		4 Octets	
VL.ARZF2	Profinet	2417	DWord	
	sercos [®] III		4 Octets	
VL.ARZF3	Profinet	2418	DWord	
	sercos [®] III		4 Octets	
VL.ARZF4	Profinet	2419	DWord	
	sercos [®] III		4 Octets	

Fieldbus	Index/Subindex		Is 64 bit?	Attributes	Signed?	Object Start Version
Modbus	832	VL.ARZF1	No	32 bit	No	M_01-03-00-000
	834	VL.ARZF2				
	836	VL.ARZF3				
	838	VL.ARZF4				

Description

VL.ARZF1 sets the natural frequency of the zero (numerator) of AR filter 1. This value is F_z in the approximate transfer function of the filter:

$$ARx(s) = [s^2 / (2\pi F_z)^2 + s / (Q_z 2\pi F_z) + 1] / [s^2 / (2\pi F_p)^2 + s / (Q_p 2\pi F_p) + 1]$$

The following block diagram describes the AR filter function; note that AR1 and AR2 are in the forward path, while AR3 and AR4 are applied to feedback:

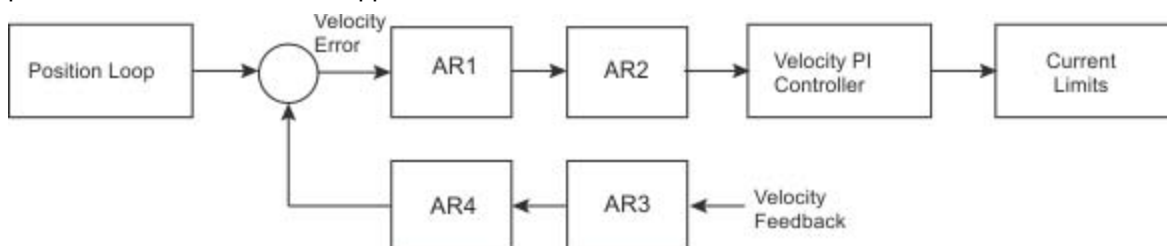

AR1, AR2, AR3, and AR4 are used in velocity and position mode, but are disabled in torque mode.

Discrete time transfer function (applies to all AR filters)

The velocity loop compensation is actually implemented as a digital discrete time system function on the DSP. The continuous time transfer function is converted to the discrete time domain by a backward Euler mapping:

$$s \approx (1-z^{-1})/t, \text{ where } t = 62.5 \mu\text{s}$$

The poles are prewarped to F_p and the zeros are prewarped to F_z .

7.39.5 VL.ARZQ1 TO VL.ARZQ4

General Information	
Type	R/W Parameter
Description	Sets the Q of the zero (numerator) of anti-resonance filter #1; active in opmodes 1 (velocity) and 2 (position) only.
Units	N/A
Range	0.1 to 5
Default Value	0.5
Data Type	Float
See Also	VL.ARPF1 TO VL.ARPF4 (pg 732), VL.ARPQ1 TO VL.ARPQ4 (pg 734), VL.ARZF1 TO VL.ARZF4 (pg 738)
Start Version	M_01-02-00-000

Variants Supported

Variant	Supported
AKD Base	Yes
AKD with Position Indexer	Yes
AKD EtherCAT	Yes
AKD CANopen	Yes
AKD BASIC	Yes
AKD SynqNet	Yes
AKD EtherNet/IP	Yes
AKD Profinet	Yes
AKD sercos [®] III	Yes
AKD-N	Yes
AKD-C	No

Fieldbus Information

Fieldbus	Index/Subindex	Object Start Version
EtherCAT COE and CANopen CANopen	3406h/D	VL.ARZQ1
	3406h/E	VL.ARZQ2
	3406h/F	VL.ARZQ3
	3406h/10	VL.ARZQ4
		M_01-02-00-000

Parameter	Fieldbus	Address	Attributes	Signed?
VL.ARZQ1	Profinet	2420	DWord	No
	sercos [®] III		4 Octets	
VL.ARZQ2	Profinet	2421	DWord	
	sercos [®] III		4 Octets	
VL.ARZQ3	Profinet	2422	DWord	
	sercos [®] III		4 Octets	
VL.ARZQ4	Profinet	2423	DWord	
	sercos [®] III		4 Octets	

Fieldbus	Index/Subindex		Is 64 bit?	Attributes	Signed?	Object Start Version
Modbus	840	VL.ARZQ1	No	32 bit	No	M_01-03-00-000
	842	VL.ARZQ2				
	844	VL.ARZQ3				
	846	VL.ARZQ4				

Description

VL.ARZQ1 sets the Q (quality factor) of the zero (numerator) of AR filter 1. This value is Q_z in the approximate transfer function of the filter:

$$AR1(s) = [s^2 / (2\pi F_z)^2 + s / (Q_z 2\pi F_z) + 1] / [s^2 / (2\pi F_p)^2 + s / (Q_p 2\pi F_p) + 1]$$

The following block diagram describes the AR filter function; note that AR1 and AR2 are in the forward path, while AR3 and AR4 are applied to feedback:

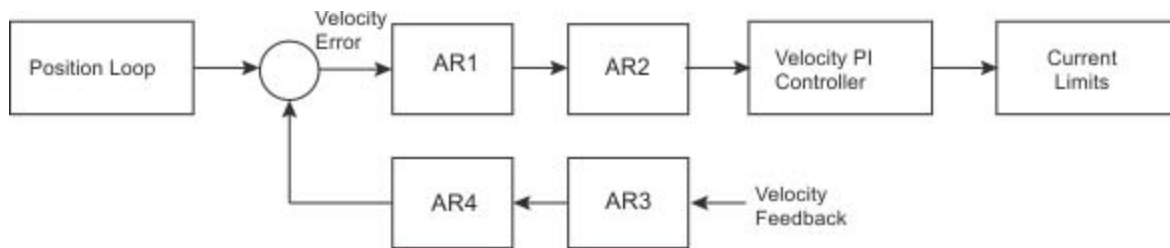

AR1, AR2, AR3 and AR4 are used in velocity and position mode, but are disabled in torque mode.

Discrete time transfer function (applies to all AR filters)

The velocity loop compensation is actually implemented as a digital discrete time system function on the DSP. The continuous time transfer function is converted to the discrete time domain by a backward Euler mapping:

$$s \approx (1-z^{-1})/t, \text{ where } t = 62.5 \mu s.$$

The poles are prewarped to F_p and the zeros are prewarped to F_z .

7.39.6 VL.BUSFF

General Information	
Type	R/O Parameter
Description	Displays the velocity loop feedforward value injected by the field-bus; active in opmodes 1 (velocity) and 2 (position) only.
Units	Depends on UNIT.VROTARY (pg 720) or UNIT.VLINEAR (pg 719) Rotary: rpm, rps, deg/s, (custom units)/s, rad/s Linear: counts/s, mm/s, µm/s, (custom units)/s
Range	0.0 to VL.LIMITP (pg 762)
Default Value	0.0
Data Type	Float
See Also	VL.FF (pg 751), VL.KBUSFF (pg 753)
Start Version	M_01-00-00-000

Variants Supported

Variant	Supported
AKD Base	Yes
AKD with Position Indexer	Yes
AKD EtherCAT	Yes
AKD CANopen	Yes
AKD BASIC	Yes
AKD SynqNet	Yes
AKD EtherNet/IP	Yes
AKD Profinet	Yes
AKD sercos [®] III	Yes
AKD-N	Yes
AKD-C	No

Fieldbus Information

Fieldbus	Index/Subindex	Object Start Version
EtherCAT COE and CANopen CANopen	60B1h/0	M_01-00-00-000

Fieldbus	Parameter	Address	Attributes	Signed?
Profinet sercos [®] III	VL.BUSFF_32	2424	DWord 8 Octets	Yes

Fieldbus	Index/Subindex	Is 64 bit?	Attributes	Signed?	Object Start Version
Modbus	848	Yes	low 32 bit word	Yes	M_01-03-00-000

Description

This parameter displays the velocity loop feedforward value injected by the fieldbus.

7.39.7 VL.CMD

General Information	
Type	R/O Parameter
Description	Reads the actual velocity command; active in opmodes 1 (velocity) and 2 (position) only.
Units	Depends on UNIT.VROTARY (pg 720) or UNIT.VLINEAR (pg 719) Rotary: rpm, rps, deg/s, (custom units)/s, rad/s Linear: counts/s, mm/s, μm/s, (custom units)/s
Range	N/A
Default Value	N/A
Data Type	Float
See Also	VL.FB (pg 747), VL.CMDU (pg 744), VL.LIMITP (pg 762), VL.LIMITN (pg 760)
Start Version	M_01-00-00-000

Variants Supported

Variant	Supported
AKD Base	Yes
AKD with Position Indexer	Yes
AKD EtherCAT	Yes
AKD CANopen	Yes
AKD BASIC	Yes
AKD SynqNet	Yes
AKD EtherNet/IP	Yes
AKD Profinet	Yes
AKD sercos [®] III	Yes
AKD-N	Yes
AKD-C	No

Fieldbus Information

Fieldbus	Index/Subindex	Object Start Version
EtherCAT COE and CANopen CANopen	606Bh/0	M_01-00-00-000

Fieldbus	Parameter	Address	Attributes	Signed?
Profinet sercos [®] III	VL.CMD_32	2425	DWord 8 Octets	Yes

Fieldbus	Index/Subindex	Is 64 bit?	Attributes	Signed?	Object Start Version
Modbus	850	Yes	low 32 bit word	Yes	M_01-03-00-000

Description

VL.CMD returns the actual velocity command as it is received in the velocity loop entry after all velocity limits (such as VL.LIMITN (pg 760) and VL.LIMITP (pg 762)). See velocity loop design diagram for more details.

7.39.8 VL.CMDU

General Information	
Type	R/W Parameter
Description	Sets the user velocity command; active in opmodes 1 (velocity) and 2 (position) only.
Units	Depends on UNIT.VROTARY (pg 720) or UNIT.VLINEAR (pg 719) Rotary: rpm, rps, deg/s, custom units/s, rad/s Linear: counts/s, mm/s, µm/s, custom units/s
Range	Rotary -15,000.000 to 15,000.000 rpm -250.000 to 250.000 rps -90000.000 to 90000.000 deg/s -1250.000 to 1250.000 custom units/s -1570.796 to 1570.796 rad/s Linear -1,073,741,824,000.000 to 1,073,741,824,000.000 counts/s -8,000.000 to 8,000.000 mm/s -8,000,000.000 to 8,000,000.000 µm/s -1,250.000 to 1,250.000 custom units/s
Default Value	0
Data Type	Float
See Also	VL.FB (pg 747), VL.CMD (pg 743), DRV.OPMODE (pg 370), DRV.CMDSOURCE (pg 312), VL.LIMITN (pg 760), VL.LIMITP (pg 762)
Start Version	M_01-00-00-000

Variants Supported

Variant	Supported
AKD Base	Yes
AKD with Position Indexer	Yes
AKD EtherCAT	Yes
AKD CANopen	Yes
AKD BASIC	Yes
AKD SynqNet	Yes
AKD EtherNet/IP	Yes
AKD Profinet	Yes
AKD sercos [®] III	Yes
AKD-N	Yes
AKD-C	No

Fieldbus Information

Fieldbus	Index/Subindex	Object Start Version
EtherCAT COE and CANopen CANopen	60FFh/0	M_01-00-00-000

Fieldbus	Parameter	Address	Attributes	Signed?
Profinet	VL.CMDU_32	2426	DWord	Yes
sercos [®] III			8 Octets	

Fieldbus	Index/Subindex	Is 64 bit?	Attributes	Signed?	Object Start Version
Modbus	852	Yes	low 32 bit word	Yes	M_01-03-00-000

Description

VL.CMDU sets the user velocity command. When DRV.OPMODE (pg 370) is set to 1 (velocity loop) and DRV.CMDSOURCE (pg 312) is set to 0 (TCP/IP channel), then setting this value when the drive is enabled will cause the drive to rotate at the required velocity.

7.39.9 VL.ERR

General Information	
Type	R/O Parameter
Description	Sets the velocity error; active in opmodes 1 (velocity) and 2 (position) only.
Units	Depends on UNIT.VROTARY (pg 720) or UNIT.VLINEAR (pg 719) Rotary: rpm, rps, deg/s, (custom units)/s, rad/s Linear: counts/s, mm/s, µm/s, (custom units)/s
Range	N/A
Default Value	N/A
Data Type	Float
See Also	VL.CMD (pg 743), VL.FB (pg 747)
Start Version	M_01-00-00-000

Variants Supported

Variant	Supported
AKD Base	Yes
AKD with Position Indexer	Yes
AKD EtherCAT	Yes
AKD CANopen	Yes
AKD BASIC	Yes
AKD SynqNet	Yes
AKD EtherNet/IP	Yes
AKD Profinet	Yes
AKD sercos [®] III	Yes
AKD-N	Yes
AKD-C	No

Fieldbus Information

Fieldbus	Index/Subindex	Object Start Version
EtherCAT COE and CANopen CANopen	3407h/4	M_01-00-00-000

Fieldbus	Parameter	Address	Attributes	Signed?
Profinet sercos [®] III	VL.ERR_32	2427	DWord 8 Octets	Yes

Fieldbus	Index/Subindex	Is 64 bit?	Attributes	Signed?	Object Start Version
Modbus	854	Yes	low 32 bit word	Yes	M_01-03-00-000

Description

VL.ERR sets the velocity error. It is calculated in the velocity loop as the difference between VL.CMD (pg 743) and VL.FB (pg 747).

7.39.10 VL.FB

General Information	
Type	R/O Parameter
Description	Reads the velocity feedback; active in opmodes 1 (velocity) and 2 (position) only.
Units	Depends on UNIT.VROTARY (pg 720) or UNIT.VLINEAR (pg 719) Rotary: rpm, rps, deg/s, (custom units)/s, rad/s Linear: counts/s, mm/s, µm/s, (custom units)/s
Range	N/A
Default Value	N/A
Data Type	Float
See Also	VL.CMDU (pg 744)
Start Version	M_01-00-00-000

Variants Supported

Variant	Supported
AKD Base	Yes
AKD with Position Indexer	Yes
AKD EtherCAT	Yes
AKD CANopen	Yes
AKD BASIC	Yes
AKD SynqNet	Yes
AKD EtherNet/IP	Yes
AKD Profinet	Yes
AKD sercos [®] III	Yes
AKD-N	Yes
AKD-C	No

Fieldbus Information

Fieldbus	Index/Subindex	Object Start Version
EtherCAT COE and CANopen CANopen	3618h/0 606Ch/0	M_01-00-00-000

Fieldbus	Parameter	Address	Attributes	Signed?
Profinet sercos [®] III	VL.FB_32	2428	DWord 8 Octets	Yes

Fieldbus	Index/Subindex	Is 64 bit?	Attributes	Signed?	Object Start Version
Modbus	856	Yes	low 32 bit word	Yes	M_01-03-00-000

Description

VL.FB returns the velocity feedback as it is received in the velocity loop, after passing through Filter 3 and Filter 4.

7.39.11 VL.FBFILTER

General Information	
Type	R/O Parameter
Description	Filters VL.FB (pg 747) value; active in opmodes 1 (velocity) and 2 (position) only.
Units	Depends on UNIT.VROTARY (pg 720) or UNIT.VLINEAR (pg 719) Rotary: rpm, rps, deg/s, (custom units)/s, rad/s Linear: counts/s, mm/s, µm/s, (custom units)/s
Range	N/A
Default Value	N/A
Data Type	Float
See Also	VL.FB (pg 747)
Start Version	M_01-00-00-000

Variants Supported

Variant	Supported
AKD Base	Yes
AKD with Position Indexer	Yes
AKD EtherCAT	Yes
AKD CANopen	Yes
AKD BASIC	Yes
AKD SynqNet	Yes
AKD EtherNet/IP	Yes
AKD Profinet	Yes
AKD sercos [®] III	Yes
AKD-N	Yes
AKD-C	No

Fieldbus Information

Fieldbus	Index/Subindex	Object Start Version
EtherCAT COE and CANopen CANopen	3407h/1	M_01-00-00-000

Fieldbus	Parameter	Address	Attributes	Signed?
Profinet sercos [®] III	VL.FBFILTER_32	2429	DWord 8 Octets	Yes

Fieldbus	Index/Subindex	Is 64 bit?	Attributes	Signed?	Object Start Version
Modbus	858	Yes	low 32 bit word	Yes	M_01-03-00-000

Description

This parameter returns the same value as VL.FB (pg 747), filtered through a 10 Hz filter.

7.39.12 VL.FBSOURCE

General Information	
Type	NV Parameter
Description	Sets feedback source for the velocity loop; active in opmodes 1 (velocity) and 2 (position) only.
Units	N/A
Range	0 to 1
Default Value	0
Data Type	Integer
See Also	PL.FBSOURCE (pg 623)
Start Version	M_01-00-00-000

Variants Supported

Variant	Supported
AKD Base	Yes
AKD with Position Indexer	Yes
AKD EtherCAT	Yes
AKD CANopen	Yes
AKD BASIC	Yes
AKD SynqNet	Yes
AKD EtherNet/IP	Yes
AKD Profinet	Yes
AKD sercos [®] III	Yes
AKD-N	No
AKD-C	No

Fieldbus Information

Fieldbus	Address	Attributes	Signed?
Profinet	2430	Byte	No
sercos [®] III		2 Octets	

Fieldbus	Index/Subindex	Is 64 bit?	Attributes	Signed?	Object Start Version
Modbus	860	No	8 bit	No	M_01-03-00-000

Description

This parameter determines the feedback source to be used by the velocity loop. A value of 0 selects the primary feedback, and 1 selects the secondary feedback.

7.39.13 VL.FBUNFILTERED

General Information	
Type	R/O Parameter
Description	Reads the velocity feedback.
Units	Depends on UNIT.VROTARY or UNIT.VLINEAR, UNIT.ACCLINEAR Rotary: rpm, rps, deg/s, (custom units)/s, rad/s Linear: counts/s, mm/s, µm/s, (custom units)/s
Range	N/A
Default Value	N/A
Data Type	Float
See Also	VL.FB (pg 747), VL.FBFILTER (pg 748)
Start Version	M_01-03-06-000

Variants Supported

Variant	Supported
AKD Base	Yes
AKD with Position Indexer	Yes
AKD EtherCAT	Yes
AKD CANopen	Yes
AKD BASIC	Yes
AKD SynqNet	Yes
AKD EtherNet/IP	Yes
AKD Profinet	Yes
AKD sercos [®] III	Yes
AKD-N	Yes
AKD-C	No

Fieldbus Information

Fieldbus	Address	Attributes	Signed?
Profinet	2845	DWord	Yes
sercos [®] III		8 Octets	

Fieldbus	Index/Subindex	Is 64 bit?	Attributes	Signed?	Object Start Version
Modbus	1690	Yes	64-bit	Yes	M_01-06-03-000

Description

VL.FBUNFILTERED reads the raw velocity feedback before any filters affect the value of this feedback.

7.39.14 VL.FF

General Information	
Type	R/O Parameter
Description	Displays the velocity loop overall feedforward value; active in opmodes 1 (velocity) and 2 (position) only.
Units	Depends on or Rotary: rpm, rps, deg/s, (custom units)/s, rad/s Linear: counts/s, mm/s, µm/s, (custom units)/s
Range	0 to VL.LIMITP (pg 762)
Default Value	0
Data Type	Float
See Also	VL.KBUSFF (pg 753)
Start Version	M_01-00-00-000

Variants Supported

Variant	Supported
AKD Base	Yes
AKD with Position Indexer	Yes
AKD EtherCAT	Yes
AKD CANopen	Yes
AKD BASIC	Yes
AKD SynqNet	Yes
AKD EtherNet/IP	Yes
AKD Profinet	Yes
AKD sercos [®] III	Yes
AKD-N	Yes
AKD-C	No

Fieldbus Information

Fieldbus	Address	Attributes	Signed?
Profinet	2431	DWord	Yes
sercos [®] III		8 Octets	

Fieldbus	Index/Subindex	Is 64 bit?	Attributes	Signed?	Object Start Version
Modbus	862	Yes	low 32 bit word	Yes	M_01-03-00-000

Description

This parameter displays the velocity loop overall feedforward value.

7.39.15 VL.GENMODE

General Information	
Type	NV Parameter
Description	Selects mode of velocity generation (Observer, d/dt); active in opmodes 1 (velocity) and 2 (position) only.
Units	N/A
Range	0 to 1
Default Value	0
Data Type	Integer
Start Version	M_01-00-00-000

Variants Supported

Variant	Supported
AKD Base	Yes
AKD with Position Indexer	Yes
AKD EtherCAT	Yes
AKD CANopen	Yes
AKD BASIC	Yes
AKD SynqNet	Yes
AKD EtherNet/IP	Yes
AKD Profinet	Yes
AKD sercos [®] III	Yes
AKD-N	Yes
AKD-C	No

Fieldbus Information

Fieldbus	Address	Attributes	Signed?
Profinet	2432'	Word	No
sercos [®] III		2 Octets	

Fieldbus	Index/Subindex	Is 64 bit?	Attributes	Signed?	Object Start Version
Modbus	864	No	16 bit	No	M_01-03-00-000

Description

This parameter is used to select the velocity generator mode.

Mode	Description
0	d/dt mode: The derivative of the mechanical angle of the drive is fed to a first order low pass.
1	Luenberger Observer mode

7.39.16 VL.KBUSFF

General Information	
Type	R/W Parameter
Description	Sets the velocity loop acceleration feedforward gain value; active in opmodes 1 (velocity) and 2 (position) only.
Units	NA
Range	0.0 to 2.0
Default Value	0.0
Data Type	Float
See Also	VL.BUSFF (pg 742)
Start Version	M_01-00-00-000

Variants Supported

Variant	Supported
AKD Base	Yes
AKD with Position Indexer	Yes
AKD EtherCAT	Yes
AKD CANopen	Yes
AKD BASIC	Yes
AKD SynqNet	Yes
AKD EtherNet/IP	Yes
AKD Profinet	Yes
AKD sercos [®] III	Yes
AKD-N	Yes
AKD-C	No

Fieldbus Information

Fieldbus	Index/Subindex	Object Start Version
EtherCAT COE and CANopen CANopen	3407h/3	M_01-00-00-000

Fieldbus	Address	Attributes	Signed?
Profinet	2433	DWord	No
sercos [®] III		4 Octets	

Fieldbus	Index/Subindex	Is 64 bit?	Attributes	Signed?	Object Start Version
Modbus	866	No	32 bit	No	M_01-03-00-000

Description

This parameter sets the gain for the acceleration feedforward (a scaled second derivative of the position command is added to the velocity command value).

The nominal feedforward value can be multiplied by this gain value.

This will have affect only when using position mode (DRV.OPMODE (pg 370) = 2).

7.39.17 VL.KI

General Information	
Type	NV Parameter
Description	Sets the velocity loop integral gain for the PI controller; active in opmodes 1 (velocity) and 2 (position) only.
Units	Hz
Range	0 to 1,000 Hz
Default Value	160 Hz
Data Type	Float
See Also	VL.KP (pg 757)
Start Version	M_01-00-00-000

Variants Supported

Variant	Supported
AKD Base	Yes
AKD with Position Indexer	Yes
AKD EtherCAT	Yes
AKD CANopen	Yes
AKD BASIC	Yes
AKD SynqNet	Yes
AKD EtherNet/IP	Yes
AKD Profinet	Yes
AKD sercos [®] III	Yes
AKD-N	Yes
AKD-C	No

Fieldbus Information

Fieldbus	Index/Subindex	Object Start Version
EtherCAT COE and CANopen CANopen	354Dh/0	M_01-00-00-000

Fieldbus	Address	Attributes	Signed?
Profinet	2434	DWord	No
sercos [®] III		4 Octets	

Fieldbus	Index/Subindex	Is 64 bit?	Attributes	Signed?	Object Start Version
Modbus	868	No	32 bit	No	M_01-03-00-000

Description

VL.KI sets the integral gain of the velocity loop.

A factor of 2π is included in the time calculation, therefore a PI velocity loop with a constant error of 1 rps in which VL.KI is set to 160 and VL.KP (pg 757) is set to 1, will take $(1000/160)*2\pi$ ms to increase the integral gain to 1. Therefore, the total gain is 2 at this time (see velocity loop structure below).

Velocity Loop Structure

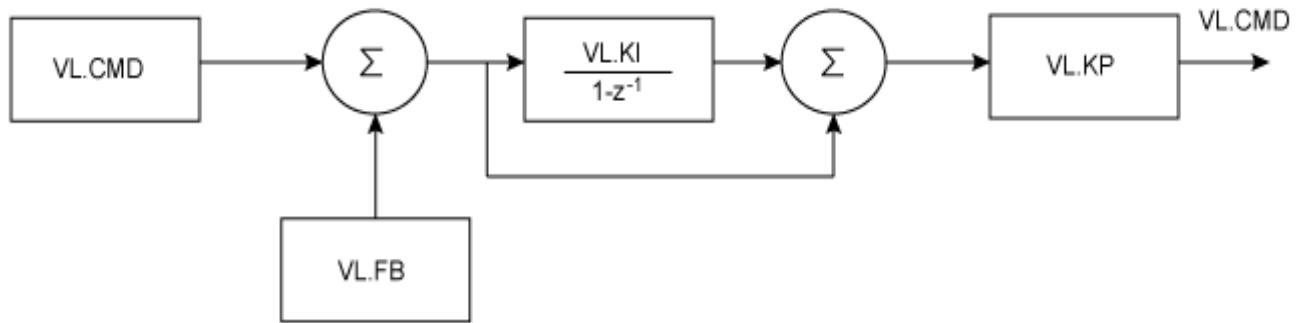

7.39.18 VL.KO

General Information	
Type	R/W Parameter
Description	Scales the observer velocity signal; active in opmodes 1 (velocity) and 2 (position) only.
Units	Internal
Range	0 to 65,535
Default Value	0
Data Type	Float
See Also	VL.MODEL (pg 765)
Start Version	M_01-00-01-000

Variants Supported

Variant	Supported
AKD Base	Yes
AKD with Position Indexer	Yes
AKD EtherCAT	Yes
AKD CANopen	Yes
AKD BASIC	Yes
AKD SynqNet	Yes
AKD EtherNet/IP	Yes
AKD Profinet	Yes
AKD sercos [®] III	Yes
AKD-N	Yes
AKD-C	No

Fieldbus Information

Fieldbus	Address	Attributes	Signed?
Profinet	2435	DWord	No
sercos [®] III		4 Octets	

Fieldbus	Index/Subindex	Is 64 bit?	Attributes	Signed?	Object Start Version
Modbus	870	No	32 bit	No	M_01-03-00-000

Description

VL.KO is used to scale the observer model to match the load. When VL.KO is tuned properly, Reads the observer velocity signal; active in opmodes 1 (velocity) and 2 (position) only. (pg 765) will match VL.FB (pg 747), except when there is an unspecified offset between the two.

7.39.19 VL.KP

General Information	
Type	NV Parameter
Description	Sets velocity loop proportional gain for the PI controller; active in opmodes 1 (velocity) and 2 (position) only.
Units	A/(rad/sec)
Range	0.001 to 2,147,483.008
Default Value	1
Data Type	Float
See Also	VL.KI (pg 754)
Start Version	M_01-00-00-000

Variants Supported

Variant	Supported
AKD Base	Yes
AKD with Position Indexer	Yes
AKD EtherCAT	Yes
AKD CANopen	Yes
AKD BASIC	Yes
AKD SynqNet	Yes
AKD EtherNet/IP	Yes
AKD Profinet	Yes
AKD sercos [®] III	Yes
AKD-N	Yes
AKD-C	No

Fieldbus Information

Fieldbus	Index/Subindex	Object Start Version
EtherCAT COE and CANopen CANopen	3548h/0	M_01-00-00-000

Fieldbus	Address	Attributes	Signed?
Profinet	2436	DWord	No
sercos [®] III		4 Octets	

Fieldbus	Index/Subindex	Is 64 bit?	Attributes	Signed?	Object Start Version
Modbus	872	No	32 bit	No	M_01-03-00-000

Description

VL.KP sets the proportional gain of the velocity loop.

The idealized velocity loop bandwidth in Hz is:

Rotary motor:

$$\text{Bandwidth (Hz)} = \text{VL.KP} * K_t / (2\pi * J_m)$$

Where:

K_t = motor torque constant, in units of Nm/Arms

J_m = motor inertia, in units of kg*m²

Linear motor:

$$\text{Bandwidth (Hz)} = \text{VL.KP} * K_t / (\text{Motor Pitch (mm)} * J_m)$$

Where:

K_t = motor torque constant, in units of Nm/Arms

J_m = motor inertia, in units of kg

The drive uses the same control loop for both linear and rotary motors. VL.KP units are in Arms/(rad/s). If you want to tune in units of Arms/(mm/s), then you must manually convert the units.

The diagram below shows how linear motors are implemented at the control loop level.

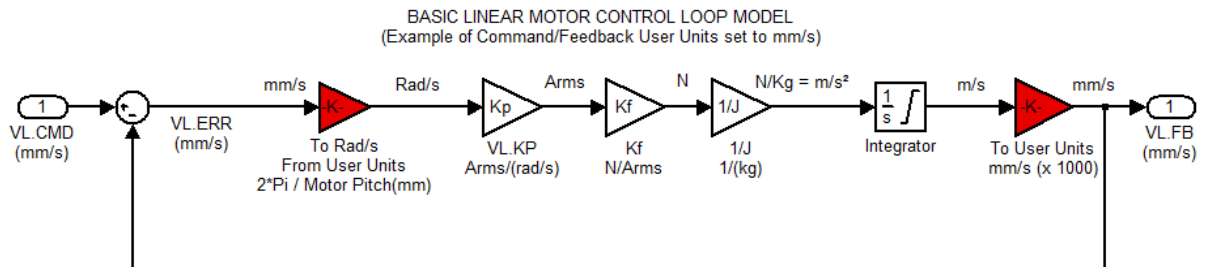

The red blocks are automatically handled at the drive level.

2π radians is the linear equivalent of one full mechanical revolution of a rotary motor - and is equal to the MOTOR.PITCH of a linear motor.

Example

To convert VL.KP = 0.320 Arms/(rad/s) to Arms/(mm/s), where MOTOR.PITCH is 32 mm:

$$\text{VL.KP} = 0.320 \text{ Arm /rad/s} * (2\pi \text{ rad} / 32\text{mm MOTOR.PITCH})$$

$$\text{VL.KP} = 0.32 * 2\pi / 32 = 0.063 \text{ Arms / (mm/s)}$$

7.39.20 VL.KVFF

General Information	
Type	R/W Parameter
Description	Sets the velocity loop velocity feedforward gain value; active in opmodes 1 (velocity) and 2 (position) only.
Units	NA
Range	0.0 to 2.0
Default Value	0.0
Data Type	Float
See Also	VL.FF (pg 751)
Start Version	M_01-00-00-000

Variants Supported

Variant	Supported
AKD Base	Yes
AKD with Position Indexer	Yes
AKD EtherCAT	Yes
AKD CANopen	Yes
AKD BASIC	Yes
AKD SynqNet	Yes
AKD EtherNet/IP	Yes
AKD Profinet	Yes
AKD sercos [®] III	Yes
AKD-N	Yes
AKD-C	No

Fieldbus Information

Fieldbus	Index/Subindex	Object Start Version
EtherCAT COE and CANopen CANopen	3407h/2 354Bh/0	M_01-00-00-000

Fieldbus	Address	Attributes	Signed?
Profinet	2437	DWord	No
sercos [®] III		4 Octets	

Fieldbus	Index/Subindex	Is 64 bit?	Attributes	Signed?	Object Start Version
Modbus	874	No	32 bit	No	M_01-03-00-000

Description

This parameter sets the gain for the velocity feedforward (a scaled derivative of the position command is added to the velocity command value). The nominal feedforward value can be multiplied by this gain value.

This parameter is only used in the position mode (DRV.OPMODE (pg 370) = 2).

7.39.21 VL.LIMITN

General Information	
Type	NV Parameter
Description	Sets the velocity lower limit; active in opmodes 1 (velocity) and 2 (position) only.
Units	Depends on UNIT.VROTARY (pg 720) or UNIT.VLINEAR (pg 719) Rotary: rpm, rps, deg/s, custom units/s, rad/s Linear: counts/s, mm/s, $\mu\text{m/s}$, custom units/s
Range	Rotary: -15,000.000 to 0.000 rpm -250.000 to 0.000 rps -90,000.000 to 0.000 deg/s -1,250.000 to 0.000 custom units/s -1570.796 to 0.000 rad/s Linear: -1,073,741,824,000.000 to 0.000 counts/s -250.000*MOTOR.PITCH (pg 570) to 0.000 mm/s -250,000.000*MOTOR.PITCH (pg 570) to 0.000 $\mu\text{m/sec}$ -1,250.000 to 0.000 custom units/s
Default Value	Rotary: -3,000.000 rpm -50.000 rps -18,000.002 deg/s -250.000 (custom units)/s -314.159 rad/s Linear: -0.050 counts/s -50*MOTOR.PITCH (pg 570) mm/s -50,000.004*MOTOR.PITCH $\mu\text{m/sec}$ -250.000 custom units/s
Data Type	Float
See Also	VL.LIMITP (pg 762), VL.CMD (pg 743)
Start Version	M_01-00-00-000

Variants Supported

Variant	Supported
AKD Base	Yes
AKD with Position Indexer	Yes
AKD EtherCAT	Yes
AKD CANopen	Yes
AKD BASIC	Yes
AKD SynqNet	Yes
AKD EtherNet/IP	Yes
AKD Profinet	Yes
AKD sercos [®] III	Yes

Variant	Supported
AKD-N	Yes
AKD-C	No

Fieldbus Information

Fieldbus	Index/Subindex	Object Start Version
EtherCAT COE and CANopen CANopen	3623h/0	M_01-00-00-000

Fieldbus	Parameter	Address	Attributes	Signed?
Profinet	VL.LIMITN_32	2438	DWord	Yes
sercos [®] III			8 Octets	

Fieldbus	Index/Subindex	Is 64 bit?	Attributes	Signed?	Object Start Version
Modbus	876	Yes	low 32 bit word	Yes	M_01-03-00-000

Description

VL.LIMITN sets the velocity command negative limit.

If the input to the velocity loop is lower than VL.LIMITN, then the actual velocity command VL.CMD (pg 743) is limited by the value of VL.LIMITN.

7.39.22 VL.LIMITP

General Information	
Type	NV Parameter
Description	Sets the velocity high limit; active in opmodes 1 (velocity) and 2 (position) only.
Units	Depends on UNIT.VROTARY (pg 720) or UNIT.VLINEAR (pg 719) Rotary: rpm, rps, deg/s, custom units/s, rad/s Linear: counts/s, mm/s, $\mu\text{m/s}$, custom units/s
Range	Rotary: 0.000 to 15,000.000 rpm 0.000 to 250.000 rps 0.000 to 90,000.000 deg/s 0.000 to 1,250.000 custom units/s 0.000 to 1570.796 rad/s Linear: 0.000 to 1,073,741,824,000.000 counts/s 0.000 to 250.000*MOTOR.PITCH (pg 570) mm/sec 0.000 to 250,000.000*MOTOR.PITCH (pg 570) $\mu\text{m/s}$ 0.000 to 1,250.000 custom units/s
Default Value	Rotary: 3,000.000 rpm 50.000 rps 18,000.002 deg/s 250.000 (custom units)/s 314.159 rad/s Linear: 0.050 counts/s 50.000*MOTOR.PITCH (pg 570) mm/sec 50,000.004*MOTOR.PITCH $\mu\text{m/sec}$ 250.000 custom units/s
Data Type	Float
See Also	VL.LIMITN (pg 760), VL.CMD (pg 743)
Start Version	M_01-00-00-000

Variants Supported

Variant	Supported
AKD Base	Yes
AKD with Position Indexer	Yes
AKD EtherCAT	Yes
AKD CANopen	Yes
AKD BASIC	Yes
AKD SynqNet	Yes
AKD EtherNet/IP	Yes
AKD Profinet	Yes
AKD sercos [®] III	Yes

Variant	Supported
AKD-N	Yes
AKD-C	No

Fieldbus Information

Fieldbus	Index/Subindex	Object Start Version
EtherCAT COE and CANopen CANopen	3622h/0	M_01-00-00-000

Fieldbus	Parameter	Address	Attributes	Signed?
Profinet	VL.LIMITP_32	2439	DWord	No
sercos® III			8 Octets	

Fieldbus	Index/Subindex	Is 64 bit?	Attributes	Signed?	Object Start Version
Modbus	878	Yes	low 32 bit word	No	M_01-03-00-000

Description

VL.LIMITP sets the velocity command positive limit.

If the input to the velocity loop is higher than VL.LIMITP, then the actual velocity command VL.CMD (pg 743) is limited by the value of VL.LIMITP.

7.39.23 VL.LMJR

General Information	
Type	NV Parameter
Description	Sets the ratio of the estimated load moment of inertia relative to the motor moment of inertia; active in opmodes 1 (velocity) and 2 (position) only.
Units	NA
Range	0 to 100.0
Default Value	0
Data Type	Float
See Also	IL.FF (pg 491)
Start Version	M_01-00-00-000

Variants Supported

Variant	Supported
AKD Base	Yes
AKD with Position Indexer	Yes
AKD EtherCAT	Yes
AKD CANopen	Yes
AKD BASIC	Yes
AKD SynqNet	Yes
AKD EtherNet/IP	Yes
AKD Profinet	Yes
AKD sercos [®] III	Yes
AKD-N	Yes
AKD-C	No

Fieldbus Information

Fieldbus	Address	Attributes	Signed?
Profinet	2440	DWord	No
sercos [®] III		4 Octets	

Fieldbus	Index/Subindex	Is 64 bit?	Attributes	Signed?	Object Start Version
Modbus	880	No	32 bit	No	M_01-03-00-000

Description

This parameter is used in the internal calculation of the current loop acceleration feed forward gain value.

7.39.24 VL.MODEL

General Information	
Type	R/O Parameter
Description	Reads the observer velocity signal; active in opmodes 1 (velocity) and 2 (position) only.
Units	Depends on UNIT.VROTARY or UNIT.VLINEAR, UNIT.ACCLINEAR Rotary: rpm, rps, deg/s, (custom units)/s, rad/s Linear: counts/s, mm/s, µm/s, (custom units)/s
Range	N/A
Default Value	N/A
Data Type	Float
See Also	VL.FB (pg 747), VL.KO (pg 756)
Start Version	M_01-00-01-000

Variants Supported

Variant	Supported
AKD Base	Yes
AKD with Position Indexer	Yes
AKD EtherCAT	Yes
AKD CANopen	Yes
AKD BASIC	Yes
AKD SynqNet	Yes
AKD EtherNet/IP	Yes
AKD Profinet	Yes
AKD sercos [®] III	Yes
AKD-N	Yes
AKD-C	No

Fieldbus Information

Fieldbus	Parameter	Address	Attributes	Signed?
Profinet	VL.MODEL_32	2441	DWord	Yes
sercos [®] III			8 Octets	

Fieldbus	Index/Subindex	Is 64 bit?	Attributes	Signed?	Object Start Version
Modbus	882	Yes	low 32 bit word	Yes	M_01-03-00-000

Description

VL.MODEL is the observer velocity output. When VL.KO (pg 756) is tuned properly, VL.MODEL will match VL.FB (pg 747), except when there is an unspecified offset between the two.

7.39.25 VL.OBSBW

General Information	
Type	NV Parameter
Description	Sets the bandwidth of the observer in Hz.
Units	Hz
Range	10 to 4,000 Hz
Default Value	30 Hz
Data Type	Float
See Also	N/A
Start Version	M_01-03-00-004

Variants Supported

Variant	Supported
AKD Base	Yes
AKD with Position Indexer	Yes
AKD EtherCAT	Yes
AKD CANopen	Yes
AKD BASIC	Yes
AKD SynqNet	Yes
AKD EtherNet/IP	Yes
AKD Profinet	Yes
AKD sercos [®] III	Yes
AKD-N	Yes
AKD-C	No

Fieldbus Information

Fieldbus	Address	Attributes	Signed?
Profinet	2442	DWord	No
sercos [®] III		4 Octets	

Fieldbus	Index/Subindex	Is 64 bit?	Attributes	Signed?	Object Start Version
Modbus	884	No	32 bit	No	M_01-03-00-000

Description

This parameter sets the bandwidth of the observer in Hz. The observer passes the velocity feedback through a PID control loop that behaves like a low-pass filter with a bandwidth of VL.OBSBW.

7.39.26 VL.OBSMODE

General Information	
Type	NV Parameter
Description	Sets the observer operating mode.
Units	N/A
Range	0 to 1
Default Value	0
Data Type	Integer
See Also	N/A
Start Version	M_01-03-00-004

Variants Supported

Variant	Supported
AKD Base	Yes
AKD with Position Indexer	Yes
AKD EtherCAT	Yes
AKD CANopen	Yes
AKD BASIC	Yes
AKD SynqNet	Yes
AKD EtherNet/IP	Yes
AKD Profinet	Yes
AKD sercos [®] III	Yes
AKD-N	Yes
AKD-C	No

Fieldbus Information

Fieldbus	Address	Attributes	Signed?
Profinet	2443	DWord	No
sercos [®] III		4 Octets	

Fieldbus	Index/Subindex	Is 64 bit?	Attributes	Signed?	Object Start Version
Modbus	886	No	32 bit	No	M_01-03-00-000

Description

This parameter sets the observer operating mode. When VL.OBSMODE = 0, the observer is not part of the control loop; that is, VL.FB is used as the velocity feedback signal to the velocity loop. When VL.OBSMODE = 1, the observer is part of the control loop; VL.MODEL is used as the velocity feedback signal.

7.39.27 VL.THRESH

General Information	
Type	NV Parameter
Description	Sets the user over speed fault level.
Units	Depends on UNIT.VROTARY (pg 720) or UNIT.VLINEAR (pg 719) Rotary: rpm, rps, deg/s, custom units/s, rad/s Linear: counts/s, mm/s, $\mu\text{m/s}$, custom units/s
Range	Rotary: 0.000 to 15,000.000 rpm 0.000 to 250.000 rps 0.000 to 90,000.000 deg/s 0.000 to 1,250.000 custom units/s 0.000 to 1,570.796 rad/s Linear: 0.000 to 1,073,741,824,000.000 counts/s 0.000 to 250.000*MOTOR.PITCH (pg 570) mm/s 0.000 to 250,000.000*MOTOR.PITCHMOTOR.PITCH (pg 570) $\mu\text{m/s}$ 0.000 to 1,250.000 custom units/s
Default Value	Rotary: 3,600 rpm 60 rps 21,600.000 deg/s 300.000 custom units/s 376.991 rad/s Linear: 0.060 counts/s 60.000*MOTOR.PITCH (pg 570) mm/s 60,000.04*MOTOR.PITCHMOTOR.PITCH (pg 570) $\mu\text{m/s}$ 300.000 custom units/s
Data Type	Float
Start Version	M_01-00-00-000

Variants Supported

Variant	Supported
AKD Base	Yes
AKD with Position Indexer	Yes
AKD EtherCAT	Yes
AKD CANopen	Yes
AKD BASIC	Yes
AKD SynqNet	Yes
AKD EtherNet/IP	Yes
AKD Profinet	Yes
AKD sercos [®] III	Yes
AKD-N	Yes
AKD-C	No

Fieldbus Information

Fieldbus	Index/Subindex	Object Start Version
EtherCAT COE and CANopen CANopen	3627h/0	M_01-00-00-000

Fieldbus	Parameter	Address	Attributes	Signed?
Profinet	VL.THRESH_32	2444	DWord	Yes
sercos® III			8 Octets	

Fieldbus	Index/Subindex	Is 64 bit?	Attributes	Signed?	Object Start Version
Modbus	888	Yes	low 32 bit word	Yes	M_01-03-00-000

Description

VL.THRESH sets the user overspeed fault threshold. This threshold becomes the overall overspeed fault threshold (VL.VFTHRESH) if it is less than the motor speed threshold ($1.2 \times \text{MOTOR.VMAX}$), and for $\text{MOTOR.TYPE} = 6$ if it is less than the motor back EMF overspeed threshold ($((1.02 \times 1000 \times \text{VBUS.OVFTHRESH}) / (\text{MOTOR.KE} \times \sqrt{2}))$).

The value is considered an absolute value, hence it applies for both negative and positive velocities.

Example

VL.THRESH is set to 600 rpm. A velocity (VL.FB (pg 747)) of 700 rpm will generate an over speed fault.

7.39.28 VL.VFTHRESH

General Information	
Type	R/O Parameter
Description	Reads the overall overspeed fault threshold.
Units	N/A
Range	N/A
Default Value	N/A
Data Type	Float
Start Version	M_01-10-03-000

Variants Supported

Variant	Supported
AKD Base	Yes
AKD with Position Indexer	Yes
AKD EtherCAT	Yes
AKD CANopen	Yes
AKD BASIC	Yes
AKD SynqNet	Yes
AKD EtherNet/IP	Yes
AKD Profinet	Yes
AKD sercos [®] III	Yes
AKD-N	Yes
AKD-C	No

Description

This parameter reports the overall overspeed fault threshold. Whichever of the following thresholds has the smallest value is used as the overall overspeed fault threshold:

- User overspeed threshold (VL.THRESH).
- Motor mechanical overspeed threshold (1.2 x MOTOR.VMAX)
- If MOTOR.TYPE = 6, the motor back EMF overspeed threshold $((1.02 \times 1000 \times \text{VBUS.OVFTHRESH}) / (\text{MOTOR.KE} \times \sqrt{2}))$.

7.40 VM Parameters

This section describes the VM parameters.

7.40.1 VM.AUTOSTART	772
7.40.2 VM.ERR	773
7.40.3 VM.INTRTIMER	775
7.40.4 VM.PGMCOMPILERVERSION	776
7.40.5 VM.PGMERRORLIST	777
7.40.6 VM.RESTART	778
7.40.7 VM.START	779
7.40.8 VM.STATE	780
7.40.9 VM.STOP	781

7.40.1 VM.AUTOSTART

General Information	
Type	R/W
Description	VM.AUTOSTART specifies whether or not the program in the AKD BASIC starts executing automatically when AC power is applied.
Units	none
Range	0 to 1
Default Value	0
Data Type	Integer

Fieldbus Information

Fieldbus	Index/Subindex	Is 64 bit?	Attributes	Signed?	Object Start Version
Modbus	1152	No	32 bit	No	M_01-05-11-000

Description

VM.AUTOSTART specifies whether or not the program in the AKD BASIC starts executing automatically when AC power is applied.

- 0 = Program does not start automatically
- 1 = Program starts automatically

Set VM.AUTOSTART to 0 or 1 in the terminal in WorkBench and execute an NVSave.

7.40.2 VM.ERR

General Information	
Type	R/W
Description	Indicates what caused the most recent Runtime Error.
Units	None
Range	0 to 1000
Default Value	0
Data Type	Integer

Fieldbus Information

Fieldbus	Index/Subindex	Is 64 bit?	Attributes	Signed?	Object Start Version
Modbus	1162	No	32 bit	No	M_01-05-11-000

Description

Runtime errors are caused by the program running on the AKD BASIC trying to do something that is not allowed. For example, runtime errors occur when you attempt to write a value that is too high or too low to a particular variable. We try to catch as many errors as possible when the program is compiled, but some errors are only detected when the program is running.

Determine the particular problem causing Runtime Error (F4 Fault) by looking at the value of the VM.ERR variable. Use the Variables Window to find the value of VM.ERR.

The table below shows what each value of VM.ERR means.

Value of VM.ERR	Error Caused by:
801	Divide by zero.
802	Stack overflow.
803	Insufficient memory.
804	No interrupt handler defined.
805	Interrupt error.
806	Max string length exceeded.
807	String overflow.
808	Array out of bounds
809	Feature not supported.
810	Internal firmware/hardware error.
812	Parameter not supported.
813	Parameter access error.
814	Data not found.
815	Data invalid.
816	Data too high.
817	Data too low.
818	Param type out of range.
819	Data not divisible by 2.
820	Invalid position modulo setting.
821	Cannot read from command.
823	Enable Drive first.
824	DRV.OPMODE must be 2 (position).

Value of VM.ERR	Error Caused by:
825	DRV.CMDSOURCE must be 5 (program).
826	Cannot execute during a move.
827	Writing to read-only parameter.
828	Disable Drive first.

7.40.3 VM.INTRTIMER

General Information	
Type	R/W
Description	Sets a number of milliseconds before INTR.TIMER executes after it is called.
Units	Milliseconds
Range	100 to 1,000,000,000
Default Value	100
Data Type	Integer

Description

Sets a number of milliseconds before INTR.TIMER executes after it is called. VM.INTRTIMER always must be set before setting INTR.TIMER = 1. The real-time timer is reset each time INTR.TIMER = 1. VM.INTRTIMER can be changed in the Timer Interrupt Service Routine. To avoid run-time problems, the user needs to keep the Timer ISR short (must be less than VM.INTRTIMER).

After setting INTR.TIMER = 1, the timer set by VM.INTRTIMER will start to decrement. Once VM.INTRTIMER reaches zero, the virtual machine will finish executing the current instruction, and then jump to the Timer Interrupt function and execute it. When the Timer Interrupt is done executing the Virtual Machine will resume execution from where it left off. Each time INTR.TIMER=1 is set, the timer is restarted and the timer interrupt re-armed for execution.

Example

```
'This program turns Output 1 on for 5 seconds after
'Input 5 goes high
'----- Main Program -----
Main
  'Enable interrupt to trigger when input 5 goes high
  INTR.DIN5Hi = 1
  'set interrupt timer for 5 seconds (5000 msec)
  VM.INTRTIMER = 5000
  While 1: Wend 'Wait for something to happen
End Main
'----- Interrupt Routines -----
Interrupt DIN5Hi
  DOUT1.STATEU = 1 'Turn output 1 on
  'Turn on TIMER Interrupt (it will trigger after 5000 msec)
  INTR.TIMER = 1
  INTR.DIN5Hi = 1 'Re-enable Interrupt For Input 5
End Interrupt
Interrupt TIMER
  DOUT1.STATEU = 0 'Turn output 1 off
End Interrupt
```

Related Topics

Interrupt {Source} (pg 533)

7.40.4 VM.PGMCOMPILERVERSION

General Information	
Type	R/O
Description	Returns the compiler version of the most recent BASIC program downloaded to the drive.
Units	N/A
Range	N/A
Default Value	N/A
Data Type	N/A
Start Version	M_01-09-00-000

Description

Returns the compiler version of the most recent BASIC program downloaded to the drive.

7.40.5 VM.PGMERRORLIST

General Information	
Type	R/O
Description	Returns a list of unsupported items from the most recent BASIC program downloaded to the drive.
Units	N/A
Range	N/A
Default Value	N/A
Data Type	N/A
Start Version	M_01-09-00-000

Description

VM.PGMERRORLIST returns a list of items (such as recently added parameters) being used in the downloaded BASIC program which the installed firmware does not support. When the drive returns Fault 831 (BASIC program is invalid), you can either:

1. Use VM.PGMERRORLIST to identify and remove unsupported calls to items.
- or
2. Upgrade your firmware, and then re-compile, and re-download the BASIC program.

7.40.6 VM.RESTART

General Information	
Type	Command
Description	Causes program execution to start again from the beginning of the program.
Units	N/A
Range	N/A
Default Value	N/A
Data Type	N/A

Fieldbus Information

Fieldbus	Index/Subindex	Is 64 bit?	Attributes	Signed?	Object Start Version
Modbus	1154	No	Command	No	M_01-05-11-000

Description

Causes program execution to start again from the beginning of the program. Restart is the only way to exit from an Error Handler routine. Any interrupts, WHEN statements or loops in progress will be aborted.

NOTE

VM.RESTART does not clear the user program variables or change any program variables, any predefined variables or have any effect on motor motion by itself .

Related Topics

VM.START | VM.STOP

7.40.7 VM.START

General Information	
Type	Command
Description	Starts program execution if program has been stopped.
Units	N/A
Range	N/A
Default Value	N/A
Data Type	N/A

Fieldbus Information

Fieldbus	Index/Subindex	Is 64 bit?	Attributes	Signed?	Object Start Version
Modbus	1156	No	Command	No	M_01-05-11-000

Description

VM.START starts program execution. Or if program execution was stopped with VM.STOP, VM.START starts the program at the point it was stopped.

NOTE

This keyword is executed when the continue icon is pressed in the Program view.

Related Topics

VM.STOP (pg 781) | VM.RESTART (pg 778)

7.40.8 VM.STATE

General Information	
Type	R/O
Description	Returns the state of the AKD Virtual Machine.
Units	N/A
Range	0 to 5
Default Value	None
Data Type	Integer
Start Version	M_01-00-00-000

Description

VM.STATE contains the state of the Virtual Machine. The following numeric values correspond to the following states.

0. Valid program is currently being executed.
1. There is no valid program in the drive.
2. Valid program exists, not running now, but ready to go.
3. Valid program has terminated.
4. Program encountered run-time error.
5. Program is invalid (e.g. bad CRC).

7.40.9 VM.STOP

General Information	
Type	Command
Description	Stops Execution of the program
Units	N/A
Range	N/A
Default Value	N/A
Data Type	N/A

Fieldbus Information

Fieldbus	Index/Subindex	Is 64 bit?	Attributes	Signed?	Object Start Version
Modbus	1160	No	Command	No	M_01-05-11-000

Description

VM.STOP stops execution of the program. Use VM.START to start program execution at the point in the program VM.STOP was commanded.

Related Topics

VM.START (pg 779)

7.41 WHEN Parameters

This section describes the WHEN parameters.

7.41.1 When	783
7.41.2 WHEN.DRVHANDWHEEL	786
7.41.3 WHEN.DRVTIME	787
7.41.4 WHEN.FB1MECHPOS	788
7.41.5 WHEN.FB3P	789
7.41.6 WHEN.PLCMD	790
7.41.7 WHEN.PLFB	791

7.41.1 When

General Information	
Type	Statement
Description	The When statement is used for very fast response to certain input conditions.
Units	N/A
Range	N/A
Default Value	N/A
Data Type	N/A

Description

The When statement is used for very fast response to certain input conditions. Upon encountering and executing the When statement, program execution waits until the specified condition is satisfied. When the condition is satisfied, the when-action is executed immediately and the program continues at the next line after the When statement. The syntax is as follows:

```
When when-condition, when-action
```

The following tables lists the possible when-conditions and when actions

When-conditions
DIN1.STATE = 0 or 1
DIN2.STATE = 0 or 1
DIN3.STATE = 0 or 1
DIN4.STATE = 0 or 1
DIN5.STATE = 0 or 1
DIN6.STATE = 0 or 1
DIN7.STATE = 0 or 1
DIN21.STATE = 0 or 1
DIN22.STATE = 0 or 1
DIN23.STATE = 0 or 1
DIN24.STATE = 0 or 1
DIN25.STATE = 0 or 1
DIN26.STATE = 0 or 1
DIN27.STATE = 0 or 1
DIN28.STATE = 0 or 1
DIN29.STATE = 0 or 1
DIN30.STATE = 0 or 1
DIN31.STATE = 0 or 1
DIN32.STATE = 0 or 1
DRV.HANDWHEEL < value
DRV.HANDWHEEL > value
DRV.TIME > value
EXTENCODER.POSITION < value
EXTENCODER.POSITION > value
FB3.P > value

When-conditions
FB3.P < value
MOVE.MOVING = 0 or 1
MOVE.INPOSITION = 0 or 1
PL.CMD < value
PL.CMD > value
PL.FB < value
PL.FB > value

When-actions
CAM.ACTIVATE = 0 to 8
CAMVM.GOREL
CAMVM.GOUPDATE
CAMVM.GOVEL
CAMVM.STOP
Continue
DOUT1.STATEU = 0 or 1
DOUT2.STATEU = 0 or 1
EGEAR.RATIO = value
EGEAR.ON = 0 or 1
MOVE.ABORT
MOVE.GOABS
MOVE.GOREL
MOVE.GOVEL
MOVE.GOABSREG
MOVE.GORELREG
MOVE.GOUPDATE
MOVE.GOHOME

Interrupts are active and will be serviced during the execution of a When statement. The execution of an interrupt service routine will not affect how quickly the when-action is executed after the when-condition is satisfied.

The When condition is checked every 250 microseconds. At the instant (within 250 microseconds) that the when-condition is satisfied, the values of the following variables are strobed into special When variables:

Variable	When variable
DRV.HANDWHEEL	WHEN.DRVHANDWHEEL
DRV.TIME	WHEN.DRVTIME
FB1.MECHPOS	WHEN.FB1MECHPOS
PL.CMD	WHEN.PLCMD
PL.FB	WHEN.PLFB
EXTENCODER.POSITION	WHEN.EXTENCODERPOSITION

Example

```
MOVE .GOVEL
When DIN3.STATE = 1, MOVE.ABORT
```



```
Print "Motor position when Input 3 went hi, WHEN.PLFB=", WHEN.PLFB  
Print "Current Position, PLFB =", PLFB
```

Related Topics

[WHEN.DRVHANDWHEEL \(pg 786\)](#) | [WHEN.FB1MECHPOS \(pg 788\)](#) | [WHEN.DRVTIME \(pg 787\)](#)
[WHEN.PLCMD \(pg 790\)](#) | [WHEN.PLFB \(pg 791\)](#)

7.41.2 WHEN.DRVHANDWHEEL

General Information	
Type	R/O
Description	Records the value of DRV.HANDWHEEL when the when-condition is satisfied.
Units	1/4,294,967,296 rev
Range	0 to 4,294,967,295 rev
Default Value	0 rev
Data Type	Integer

Fieldbus Information

Fieldbus	Index/Subindex	Is 64 bit?	Attributes	Signed?	Object Start Version
Modbus	1170	No	32 bit	No	M_01-05-11-000

Description

Records the value of DRV.HANDWHEEL when the when-condition is satisfied. The when-condition is checked once per 250 microseconds.

Related Topics

DRV.HANDWHEEL (pg 343) | When (pg 783)

7.41.3 WHEN.DRVTIME

General Information	
Type	R/O
Description	Records the value of Time when the when-condition is satisfied.
Units	Seconds
Range	0 - 2,147,483 (~24.8 days)
Default Value	N/A
Data Type	Integer

Fieldbus Information

Fieldbus	Index/Subindex	Object Start Version
Modbus	1172	M_01-05-11-000

Description

Records the value of DRV.RUNTIME when the when-condition is satisfied. The when-condition is checked once per 250 microseconds.

Related Topics

DRV.RUNTIME (pg 374) | When (pg 783)

7.41.4 WHEN.FB1MECHPOS

General Information	
Type	R/O
Description	Records the value of FB1.MECHPOS when the when-condition is satisfied.
Units	Position units
Range	N/A
Default Value	N/A
Data Type	Integer

Fieldbus Information

Fieldbus	Index/Subindex	Is 64 bit?	Attributes	Signed?	Object Start Version
Modbus	1164	No	32 bit	No	M_01-05-11-000

Description

Records the value of FB1.MECHPOS when the when-condition is satisfied. The when-condition is checked once per 250 microseconds.

Related Topics

FB1.MECHPOS (pg 422) | When (pg 783)

7.41.5 WHEN.FB3P

General Information	
Type	R/O
Description	Records the value of FB3.P when the when-condition is satisfied.
Units	Depends on FB3.PUNIT counts or custom units.
Range	N/A
Default Value	N/A
Data Type	S64

Fieldbus Information

Fieldbus	Index/Subindex	Is 64 bit?	Attributes	Signed?	Object Start Version
Modbus	1166	Yes	64 bit	No	M_01-05-11-000

Description

Records the value of FB3.P when the when-condition is satisfied. The when-condition is checked every 250usec.

Related Topics

When (pg 783) | FB3.P (pg 465)

7.41.6 WHEN.PLCMD

General Information	
Type	R/O
Description	Records the value of PL.CMD when the when-condition is satisfied.
Units	Position units
Range	N/A
Default Value	N/A
Data Type	Integer

Fieldbus Information

Fieldbus	Index/Subindex	Is 64 bit?	Attributes	Signed?	Object Start Version
Modbus	1174	Yes	64 bit	No	M_01-05-11-000

Description

Records the value of PL.CMD when the when-condition is satisfied. The when-condition is checked once per 250 microseconds.

Related Topics

PL.CMD (pg 612) | When (pg 783)

7.41.7 WHEN.PLFB

General Information	
Type	R/O
Description	Records the value of Position when the when-condition is satisfied.
Units	Depends on UNIT.PROTARY (pg 718) or UNIT.PLINEAR (pg 716)UNIT.ACCLINEAR (pg 712) Rotary: counts, rad, deg, (Custom Units), 16-bit counts Linear: counts, mm, μm , (Custom Units), 16-bit counts
Range	N/A
Default Value	N/A
Data Type	Integer

Fieldbus Information

Fieldbus	Index/Subindex	Is 64 bit?	Attributes	Signed?	Object Start Version
Modbus	1178	Yes	64 bit	Yes	M_01-05-11-000

Description

Records the value of Position when the when-condition is satisfied. The when-condition is checked once per 250 microseconds.

Related Topics

PL.FB (pg 621) | When (pg 783)

7.42 WS Parameters

This section describes the WS parameters.

7.42.1 WS.ARM	793
7.42.2 WS.CHECKMODE	794
7.42.3 WS.CHECKT	796
7.42.4 WS.CHECKV	797
7.42.5 WS.DISARM	798
7.42.6 WS.DISTMAX	799
7.42.7 WS.DISTMIN	800
7.42.8 WS.FREQ	801
7.42.9 WS.IMAX	802
7.42.10 WS.MODE	803
7.42.11 WS.NUMLOOPS	804
7.42.12 WS.STATE	805
7.42.13 WS.T	806
7.42.14 WS.TDELAY1	807
7.42.15 WS.TDELAY2	808
7.42.16 WS.TDELAY3	809
7.42.17 WS.TIRAMP	810
7.42.18 WS.TSTANDSTILL	811
7.42.19 WS.VTHRESH	812

7.42.1 WS.ARM

General Information	
Type	Command
Description	Sets wake and shake to start at the next drive enable.
Units	N/A
Range	N/A
Default Value	N/A
Data Type	N/A
See Also	N/A
Start Version	M_01-01-00-101, M_01-02-00-000

Variants Supported

Variant	Supported
AKD Base	Yes
AKD with Position Indexer	Yes
AKD EtherCAT	Yes
AKD CANopen	Yes
AKD BASIC	Yes
AKD SynqNet	Yes
AKD EtherNet/IP	Yes
AKD Profinet	Yes
AKD sercos [®] III	Yes
AKD-N	Yes
AKD-C	No

Fieldbus Information

Fieldbus	Index/Subindex	Object Start Version
EtherCAT COE and CANopen CANopen	3494h/6	M_01-00-00-000

Fieldbus	Address	Attributes	Signed?
Profinet sercos [®] III	2445	Command	No

Fieldbus	Index/Subindex	Is 64 bit?	Attributes	Signed?	Object Start Version
Modbus	890	No	Command	No	M_01-03-00-000

Description

This command sets wake and shake to start at the next drive enable. Feedback type is not relevant for this command. If WS.STATE is 0 and the drive is disabled, then WS.STATE will change to 1 after issuing WS.ARM. With this command, wake and shake can be repeated if desired.

7.42.2 WS.CHECKMODE

General Information	
Type	R/W Parameter
Description	Select the type of commutation check to execute after Wake and Shake finds a new commutation angle.
Units	N/A
Range	0 to 2
Default Value	1
Data Type	Integer
Start Version	M_01-07-00-000

Variants Supported

Variant	Supported
AKD Base	Yes
AKD with Position Indexer	Yes
AKD EtherCAT	Yes
AKD CANopen	Yes
AKD BASIC	Yes
AKD SynqNet	Yes
AKD EtherNet/IP	Yes
AKD Profinet	Yes
AKD sercos [®] III	Yes
AKD-N	Yes
AKD-C	No

Fieldbus Information

Fieldbus	Address	Attributes	Signed?
Profinet	2867	Byte	No
sercos [®] III		2 Octets	

Fieldbus	Index/Subindex	Is 64 bit?	Attributes	Signed?
Modbus	1734	No	8-bit	No

Description

AKD supports several options to confirm a valid commutation after Wake and Shake has determined a new commutation angle. In some mechanical situations, such as if motion is inhibited, it is possible for Wake and Shake to select an incorrect angle. Commutation checks are designed to prevent unexpected motion if this occurs.

0 = No Commutation Check

If No Commutation Check is selected, neither passive nor active commutations checks will be executed.

1 = Active Commutation Check (default)

In the default Active Commutation Check mode, AKD will make a short torque move after an angle has been selected. If the motor fails to move in the expected direction, a fault will be generated.

2 = Passive Commutation Check

In the Passive Commutation Check mode, AKD will monitor torque commands and acceleration values for 10 revolutions after Wake and Shake has completed. During this time, a fault will be generated if unexpected motion is detected, such as if commanded torque and acceleration are in opposition directions. Note that this fault may also be reported if the motor experiences a large torque disturbance lasting longer than WS.CHECKT.

7.42.3 WS.CHECKT

General Information	
Type	R/W Parameter
Description	Sets the amount of time a communication error must be present before an error is thrown.
Units	ms
Range	0 to 10,000
Default Value	N/A
Data Type	U16
Start Version	M_01-06-03-000

Variants Supported

Variant	Supported
AKD Base	Yes
AKD with Position Indexer	Yes
AKD EtherCAT	Yes
AKD CANopen	Yes
AKD BASIC	Yes
AKD SynqNet	Yes
AKD EtherNet/IP	Yes
AKD Profinet	Yes
AKD sercos [®] III	Yes
AKD-N	Yes
AKD-C	No

Fieldbus Information

Fieldbus	Address	Attributes	Signed?
Profinet	2850	Word	No
sercos [®] III		2 Octets	

Fieldbus	Index/Subindex	Is 64 bit?	Attributes	Signed?
Modbus	1700	No	16-bit	No

Description

This parameter sets the amount of time a communication error must be present before an error is thrown. Commutation monitoring is disabled when this parameter is set to 0.

7.42.4 WS.CHECKV

General Information			
Type	R/W Parameter		
Description	This parameter sets the velocity threshold which has to be exceeded to activate commutation monitoring.		
Units	Depends on UNIT.VROTARY or UNIT.VLINEAR.		
Range	Unit	Rotary	Linear
	0	0 to 15,000 rpm	0 to 6,7108,864 counts/s
	1	0 to 250 rps	0 to 8,000 mm/s
	2	0 to 90,000 deg/s	0 to 589934 um/s
	3	0 to 1250 PIN/POUT	0 to 1250 PIN/POUT
Default Value	N/A		
Data Type	S32		
Start Version	M_01-06-03-000		

Variants Supported

Variant	Supported
AKD Base	Yes
AKD with Position Indexer	Yes
AKD EtherCAT	Yes
AKD CANopen	Yes
AKD BASIC	Yes
AKD SynqNet	Yes
AKD EtherNet/IP	Yes
AKD Profinet	Yes
AKD sercos [®] III	Yes
AKD-N	Yes
AKD-C	No

Fieldbus Information

Fieldbus	Address	Attributes	Signed?
Profinet	2851	DWord	Yes
sercos [®] III		8 Octets	

Fieldbus	Index/Subindex	Is 64 bit?	Attributes	Signed?
Modbus	1702	Yes	64-bit	Yes

Description

This parameter sets the velocity threshold which has to be exceeded to activate commutation monitoring.

7.42.5 WS.DISARM

General Information	
Type	Command
Description	Cancels ARM requests and resets wake and shake to the IDLE state.
Units	N/A
Range	N/A
Default Value	N/A
Data Type	N/A
See Also	N/A
Start Version	M_01-04-00-000

Variants Supported

Variant	Supported
AKD Base	Yes
AKD with Position Indexer	Yes
AKD EtherCAT	Yes
AKD CANopen	Yes
AKD BASIC	Yes
AKD SynqNet	Yes
AKD EtherNet/IP	Yes
AKD Profinet	Yes
AKD sercos [®] III	Yes
AKD-N	Yes
AKD-C	No

Fieldbus Information

Fieldbus	Address	Attributes	Signed?
Profinet	2847	Command	No
sercos [®] III			

Fieldbus	Index/Subindex	Is 64 bit?	Attributes	Signed?	Object Start Version
Modbus	1694	No	Command	No	M_01-06-03-000

Description

This command disables wake and shake immediately. Feedback type is not relevant for this command. If WS.ARM (pg 793) has been issued, the request to execute the wake and shake algorithm at the next enable is cancelled. WS.STATE (pg 805) is set to IDLE.

7.42.6 WS.DISTMAX

General Information	
Type	R/W Parameter
Description	Sets maximum movement allowed for wake and shake.
Units	deg (position units)
Range	0 to 90 deg
Default Value	15 deg
Data Type	S64
See Also	N/A
Start Version	M_01-01-00-101, M_01-02-00-000

Variants Supported

Variant	Supported
AKD Base	Yes
AKD with Position Indexer	Yes
AKD EtherCAT	Yes
AKD CANopen	Yes
AKD BASIC	Yes
AKD SynqNet	Yes
AKD EtherNet/IP	Yes
AKD Profinet	Yes
AKD sercos [®] III	Yes
AKD-N	Yes
AKD-C	No

Fieldbus Information

Fieldbus	Index/Subindex	Object Start Version
EtherCAT COE and CANopen CANopen	3494h/2	M_01-00-00-000

Fieldbus	Address	Attributes	Signed?
Profinet	2446	DWord	Yes
sercos [®] III		8 Octets	

Fieldbus	Index/Subindex	Is 64 bit?	Attributes	Signed?	Object Start Version
Modbus	892	Yes	64 bit	Yes	M_01-03-00-000

Description

This parameter sets the maximum movement that is allowed for finding commutation. If this value is too small, F475, "Wake and Shake. Too much movement", may occur before wake and shake is finished. The bigger this value, the more movement is allowed for wake and shake. This value is application dependent.

7.42.7 WS.DISTMIN

General Information	
Type	R/W Parameter
Description	Sets the minimum movement required for wake and shake.
Units	Actual position units
Range	0 to 90 deg
Default Value	1 deg
Data Type	S64
See Also	N/A
Start Version	M_01-01-00-101, M_01-02-00-000

Variants Supported

Variant	Supported
AKD Base	Yes
AKD with Position Indexer	Yes
AKD EtherCAT	Yes
AKD CANopen	Yes
AKD BASIC	Yes
AKD SynqNet	Yes
AKD EtherNet/IP	Yes
AKD Profinet	Yes
AKD sercos [®] III	Yes
AKD-N	Yes
AKD-C	No

Fieldbus Information

Fieldbus	Index/Subindex	Object Start Version
EtherCAT COE and CANopen CANopen	36D1h/0	M_01-00-00-000

Fieldbus	Address	Attributes	Signed?
Profinet	2448	DWord	Yes
sercos [®] III		8 Octets	

Fieldbus	Index/Subindex	Is 64 bit?	Attributes	Signed?	Object Start Version
Modbus	896	Yes	64 bit	Yes	M_01-03-00-000

Description

This parameter sets the minimum movement that is required for commutation finding. If this value is too small, the the commutation finding might fail if too little current is used. The larger this value, the more movement is needed in order to avoid F473: "Wake and Shake: Too little movement".

7.42.8 WS.FREQ

General Information	
Type	R/W
Description	Sets the sine frequency of excitation for WS.MODE 2.
Units	Hz
Range	0.01 - 8000
Default Value	10
Data Type	Float
Start Version	M_01-05-10-000

Variants Supported

Variant	Supported
AKD Base	Yes
AKD with Position Indexer	Yes
AKD EtherCAT	Yes
AKD CANopen	Yes
AKD BASIC	Yes
AKD SynqNet	Yes
AKD EtherNet/IP	Yes
AKD Profinet	Yes
AKD sercos [®] III	Yes
AKD-N	Yes
AKD-C	No

Fieldbus Information

Fieldbus	Address	Attributes	Signed?
Profinet	2848	DWord	No
sercos [®] III		4 Octets	

Fieldbus	Index/Subindex	Is 64 bit?	Attributes	Signed?
Modbus	1696	No	32-bit	No

Description

This keyword sets the excitation frequency for Wake and Shake mode 2.

The default setting of 10Hz will work for almost all systems.

In cases where the load attached to the motor is much higher than the motor inertia (200:1) it may be necessary to lower the value of WS.FREQ.

Effects of lowering WS.FREQ:

- Wake and Shake Mode 2 will take longer to complete.
- A higher magnitude of motion will be seen on the motor because the motor has current applied in the same direction for a longer period of time.

7.42.9 WS.IMAX

General Information	
Type	R/W Parameter
Description	Sets maximum current used for wake and shake.
Units	Arms
Range	0 to (lower value of MOTOR.IPEAK and DRV.IPEAK) Arms
Default Value	(half of maximum) Arms
Data Type	U16
See Also	MOTOR.IPEAK (pg 560), DRV.IPEAK (pg 355)
Start Version	M_01-01-00-101, M_01-02-00-000

Variants Supported

Variant	Supported
AKD Base	Yes
AKD with Position Indexer	Yes
AKD EtherCAT	Yes
AKD CANopen	Yes
AKD BASIC	Yes
AKD SynqNet	Yes
AKD EtherNet/IP	Yes
AKD Profinet	Yes
AKD sercos [®] III	Yes
AKD-N	Yes
AKD-C	No

Fieldbus Information

Fieldbus	Index/Subindex	Object Start Version
EtherCAT COE and CANopen CANopen	3494h/1	M_01-00-00-000

Fieldbus	Address	Attributes	Signed?
Profinet	2450	DWord	Yes
sercos [®] III		4 Octets	

Fieldbus	Index/Subindex	Is 64 bit?	Attributes	Signed?	Object Start Version
Modbus	900	No	32 bit	Yes	M_01-03-00-000

Description

This parameter defines the maximum current used for wake and shake. If the selected current is too low, the minimum required movement may not occur. If the selected current is too high, the movement may be too fast (overspeed) or too large (over maximum movement).

The maximum of this parameter is the lower value of MOTOR.IPEAK and DRV.IPEAK. The default value of this parameter is the half of its maximum. This value depends on the specific application.

7.42.10 WS.MODE

General Information	
Type	R/W Parameter
Description	Sets the method used for wake and shake.
Units	N/A
Range	0 to 1
Default Value	0
Data Type	U8
Start Version	M_01-01-00-101, M_01-02-00-000

Variants Supported

Variant	Supported
AKD Base	Yes
AKD with Position Indexer	Yes
AKD EtherCAT	Yes
AKD CANopen	Yes
AKD BASIC	Yes
AKD SynqNet	Yes
AKD EtherNet/IP	Yes
AKD Profinet	Yes
AKD sercos [®] III	Yes
AKD-N	Yes
AKD-C	No

Fieldbus Information

Fieldbus	Address	Attributes	Signed?
Profinet	2451	Byte	No
sercos [®] III		2 Octets	

Fieldbus	Index/Subindex	Is 64 bit?	Attributes	Signed?	Object Start Version
Modbus	902	No	8 bit	No	M_01-03-00-000

Description

This parameter sets the method used for finding commutation.

0 = Standard wake and shake

Two iterations are used to find the correct angle in this mode. Coarse (current mode) and fine (velocity mode) iterations are done in a loop (WS.NUMLOOPS times). The average angle of all loops is calculated and used.

1 = Commutation alignment by fixed commutation vector (Zero Method)

The motor poles are set to 0, current mode is activated, and WS.IMAX is applied. The angle in which the motor settles is used for commutation. Other settings are restored (such as motor poles and operation mode).

7.42.11 WS.NUMLOOPS

General Information	
Type	R/W Parameter
Description	Sets the number of repetitions for wake and shake.
Units	counts
Range	0 to 20 counts
Default Value	5 counts
Data Type	U8
See Also	N/A
Start Version	M_01-01-00-101, M_01-02-00-000

Variants Supported

Variant	Supported
AKD Base	Yes
AKD with Position Indexer	Yes
AKD EtherCAT	Yes
AKD CANopen	Yes
AKD BASIC	Yes
AKD SynqNet	Yes
AKD EtherNet/IP	Yes
AKD Profinet	Yes
AKD sercos [®] III	Yes
AKD-N	Yes
AKD-C	No

Fieldbus Information

Fieldbus	Index/Subindex	Object Start Version
EtherCAT COE and CANopen CANopen	36E2h/0	M_01-00-00-000

Fieldbus	Address	Attributes	Signed?
Profinet	2452	Byte	No
sercos [®] III		2 Octets	

Fieldbus	Index/Subindex	Is 64 bit?	Attributes	Signed?	Object Start Version
Modbus	904	No	8 bit	No	M_01-03-00-000

Description

This parameter sets the maximum number of wake and shake repetitions. MOTOR.PHASE is calculated as mean value of all wake and shake repetitions.

7.42.12 WS.STATE

General Information	
Type	R/O Parameter
Description	Reads wake and shake status.
Units	N/A
Range	N/A
Default Value	Only valid before the first enable occurs. 11 - for feedback types that do not require wake and shake 1 - for feedback types that require wake and shake
Data Type	U8
See Also	N/A
Start Version	M_01-01-00-101, M_01-02-00-000

Variants Supported

Variant	Supported
AKD Base	Yes
AKD with Position Indexer	Yes
AKD EtherCAT	Yes
AKD CANopen	Yes
AKD BASIC	Yes
AKD SynqNet	Yes
AKD EtherNet/IP	Yes
AKD Profinet	Yes
AKD sercos [®] III	Yes
AKD-N	Yes
AKD-C	No

Fieldbus Information

Fieldbus	Index/Subindex	Is 64 bit?	Attributes	Signed?	Object Start Version
Modbus	906	No	8 bit	No	M_01-03-00-000

Description

WS switches different current vectors and records position feedback in order to establish commutation alignment.

WS.STATE 0 = wake and shake successful (DONE).

WS.STATE 1 = wake and shake configured and will be done at next enable (ARMED).

WS.STATE 2 = wake and shake running. (ACTIVE)

WS.STATE 10 = error occurred during wake and shake (ERROR).

WS.STATE 11 = wake and shake not required (IDLE).

7.42.13 WS.T

General Information	
Type	R/W Parameter
Description	Sets wake and shake current-vector appliance time.
Units	ms
Range	1 to 200 ms
Default Value	2 ms
Data Type	U8
See Also	WS.IMAX (pg 802), WS.DISTMAX
Start Version	M_01-01-00-101, M_01-02-00-000

Variants Supported

Variant	Supported
AKD Base	Yes
AKD with Position Indexer	Yes
AKD EtherCAT	Yes
AKD CANopen	Yes
AKD BASIC	Yes
AKD SynqNet	Yes
AKD EtherNet/IP	Yes
AKD Profinet	Yes
AKD sercos [®] III	Yes
AKD-N	Yes
AKD-C	No

Fieldbus Information

Fieldbus	Index/Subindex	Object Start Version
EtherCAT COE and CANopen CANopen	36D0h/0	M_01-00-00-000

Fieldbus	Address	Attributes	Signed?
Profinet	2454	Word	No
sercos [®] III		2 Octets	

Fieldbus	Index/Subindex	Is 64 bit?	Attributes	Signed?	Object Start Version
Modbus	908	No	16 bit	No	M_01-03-00-000

Description

This parameter defines the duration for each different current-vector while the coarse angle calculation. The move distance is proportional to the WS.T and WS.IMAX value.

7.42.14 WS.TDELAY1

General Information	
Type	NV Parameter
Description	Delay for wake and shake timing.
Units	ms
Range	0 to 200 ms
Default Value	5 ms
Data Type	U8
See Also	N/A
Start Version	M_01-01-00-101, M_01-02-00-000

Variants Supported

Variant	Supported
AKD Base	Yes
AKD with Position Indexer	Yes
AKD EtherCAT	Yes
AKD CANopen	Yes
AKD BASIC	Yes
AKD SynqNet	Yes
AKD EtherNet/IP	Yes
AKD Profinet	Yes
AKD sercos [®] III	Yes
AKD-N	Yes
AKD-C	No

Fieldbus Information

Fieldbus	Index/Subindex	Object Start Version
EtherCAT COE and CANopen CANopen	3683h/0	M_01-00-00-000

Fieldbus	Address	Attributes	Signed?
Profinet	2455	Word	No
sercos [®] III		2 Octets	

Fieldbus	Index/Subindex	Is 64 bit?	Attributes	Signed?	Object Start Version
Modbus	910	No	16 bit	No	M_01-03-00-000

Description

WS.TDELAY1 defines the delay time of the wake and shake function. This time is a delay time between the switching of different current vectors during the wake and shake procedure. This time should be increased in the case of movement interferences between single current vectors.

7.42.15 WS.TDELAY2

General Information	
Type	NV Parameter
Description	Sets the delay for wake and shake timing.
Units	ms
Range	0 to 200 ms
Default Value	50 ms
Data Type	U8
See Also	N/A
Start Version	M_01-01-00-101, M_01-02-00-000

Variants Supported

Variant	Supported
AKD Base	Yes
AKD with Position Indexer	Yes
AKD EtherCAT	Yes
AKD CANopen	Yes
AKD BASIC	Yes
AKD SynqNet	Yes
AKD EtherNet/IP	Yes
AKD Profinet	Yes
AKD sercos [®] III	Yes
AKD-N	Yes
AKD-C	No

Fieldbus Information

Fieldbus	Index/Subindex	Object Start Version
EtherCAT COE and CANopen CANopen	3685h/0	M_01-00-00-000

Fieldbus	Address	Attributes	Signed?
Profinet	2456	Word	No
sercos [®] III		2 Octets	

Fieldbus	Index/Subindex	Is 64 bit?	Attributes	Signed?	Object Start Version
Modbus	912	No	16 bit	No	M_01-03-00-000

Description

WS.TDELAY2 defines the delay between switching from coarse angle calculation to fine angle calculation during the wake and shake procedure. This time should be increased in the case of interferences between the coarse calculation done in current mode and the fine calculation done in velocity mode. Choosing too large a value increases the wake and shake duration.

7.42.16 WS.TDELAY3

General Information	
Type	NV Parameter
Description	Sets the delay for wake and shake between loops in mode 0.
Units	ms
Range	0 to 2,000 ms
Default Value	100 ms
Data Type	U16
See Also	N/A
Start Version	M_01-01-00-102, M_01-02-00-000

Variants Supported

Variant	Supported
AKD Base	Yes
AKD with Position Indexer	Yes
AKD EtherCAT	Yes
AKD CANopen	Yes
AKD BASIC	Yes
AKD SynqNet	Yes
AKD EtherNet/IP	Yes
AKD Profinet	Yes
AKD sercos [®] III	Yes
AKD-N	Yes
AKD-C	No

Fieldbus Information

Fieldbus	Index/Subindex	Object Start Version
EtherCAT COE and CANopen CANopen	3494h/3	M_01-00-00-000

Fieldbus	Address	Attributes	Signed?
Profinet	2457	Word	No
sercos [®] III		2 Octets	

Fieldbus	Index/Subindex	Is 64 bit?	Attributes	Signed?	Object Start Version
Modbus	914	No	16 bit	No	M_01-03-00-000

Description

WS.TDELAY3 defines the delay between complete loops in mode 0 only. Decreasing this value makes the wake and shake procedure faster, but may lead to problems if the motor moves too long. Increasing this value will make wake and shake significantly longer.

7.42.17 WS.TIRAMP

General Information	
Type	R/W Parameter
Description	Sets the ramp time for the ramp up current in Wake & Shake mode 1.
Units	ms
Range	512 to 10,000
Default Value	512
Data Type	U16
Start Version	M_01-06-07-000

Variants Supported

Variant	Supported
AKD Base	Yes
AKD with Position Indexer	Yes
AKD EtherCAT	Yes
AKD CANopen	Yes
AKD BASIC	Yes
AKD SynqNet	Yes
AKD EtherNet/IP	Yes
AKD Profinet	Yes
AKD sercos [®] III	Yes
AKD-N	Yes
AKD-C	No

Fieldbus Information

Fieldbus	Index/Subindex	Object	Start Version
CANopen	0x535D/0		M_01-06-07-000

Fieldbus	Address	Attributes	Signed?
Profinet	2861	Word	No
sercos [®] III		2 Octets	

Fieldbus	Index/Subindex	Is 64 bit?	Attributes	Signed?
Modbus	1722	No	16-bit	No

Description

In Wake & Shake mode 1, a maximum current of WS.IMAX is applied to the motor. WS.TIRAMP defines a time to reach this maximum current. Longer times are useful for big inertia motors or heavy loads.

7.42.18 WS.TSTANDSTILL

General Information	
Type	R/W Parameter
Description	Sets the calming time of the motor for Wake & Shake mode 1.
Units	ms
Range	100 to 20,000
Default Value	1000
Data Type	U16
Start Version	M_01-06-07-000

Variants Supported

Variant	Supported
AKD Base	Yes
AKD with Position Indexer	Yes
AKD EtherCAT	Yes
AKD CANopen	Yes
AKD BASIC	Yes
AKD SynqNet	Yes
AKD EtherNet/IP	Yes
AKD Profinet	Yes
AKD sercos [®] III	Yes
AKD-N	Yes
AKD-C	No

Fieldbus Information

Fieldbus	Index/Subindex	Object	Start Version
CANopen	0x535C/0		M_01-06-07-000

Fieldbus	Address	Attributes	Signed?
Profinet	2860	Word	No
sercos [®] III		2 Octets	

Fieldbus	Index/Subindex	Is 64 bit?	Attributes	Signed?
Modbus	1720	No	16-bit	No

Description

In Wake & Shake mode 1, a maximum current of WS.IMAX is applied to the motor. WS.TSTANDSTILL defines a wait time, during which this maximum current is held, before detecting the commutation angle of the motor. Longer times are useful for big inertia motors or heavy loads.

7.42.19 WS.VTHRESH

General Information	
Type	NV Parameter
Description	Defines the maximum allowed velocity for Wake & Shake.
Units	Depends on UNIT.VROTARY (pg 720) or UNIT.VLINEAR (pg 719)UNIT.ACCLINEAR (pg 712) Rotary: rpm, rps, deg/s, Custom Units/s, rad/s Linear: counts/s, mm/s, µm/s, Custom Units/s
Range	Rotary: 0.000 to 15,000.000 rpm 0.000 to 250.000 rps 0.000 to 90,000.000 degree/s 0.000 to 1,250.000 Custom Units/s 0.000 to 1,570.796 rad/s Linear: 0.000 to 1,073,741,824,000.000 counts/s 0.000 to 8,000.000 mm/s 0.000 to 8,000,000.000 µm/s 0.000 to 1,250.000 Custom Units/s
Default Value	100 rpm
Data Type	U16
See Also	N/A
Start Version	M_01-01-00-101, M_01-02-00-000

Variants Supported

Variant	Supported
AKD Base	Yes
AKD with Position Indexer	Yes
AKD EtherCAT	Yes
AKD CANopen	Yes
AKD BASIC	Yes
AKD SynqNet	Yes
AKD EtherNet/IP	Yes
AKD Profinet	Yes
AKD sercos [®] III	Yes
AKD-N	Yes
AKD-C	No

Fieldbus Information

Fieldbus	Index/Subindex	Object Start Version
EtherCAT COE and CANopen CANopen	3494h/4	M_01-00-00-000

Fieldbus	Parameter	Address	Attributes	Signed?
Profinet	WS.VTHRESH_32	2458	DWord	Yes
sercos [®] III			8 Octets	

Fieldbus	Index/Subindex	Is 64 bit?	Attributes	Signed?	Object Start Version
Modbus	916	Yes	low 32 bit word	Yes	M_01-03-00-000

Description

This parameter defines the maximum allowed velocity that occurs while commutation finding is active. This supervision runs in real time, but only while wake and shake is active (WS.STATE 2 or greater, for Mode 0). If at any time while wake and shake is running a velocity higher than this value is detected, fault F478 is generated. Setting WS.VTHRESH to zero disables this feature. For Mode 1, WS.VTHRESH is only used after the initial phase-finding.

8 Appendix A: BASIC Sample Programs

The following program files are packaged for download on kollmorgen.com as Sample Programs.zip.

- Cam_ExpDampedSin.bas
- Cam_TableRealMaster.bas
- Demo_GoRel.bas
- Demo_Govel.bas
- DimVarsMath.bas
- Fault_Interrupt.bas
- Gearing_CorrectionMove.bas
- Home_HardStop1.bas
- Home_Input.bas
- Home_InputwCAP.bas
- Home_MechanicalZero.bas
- ModbusIntr_Scurve.bas
- PLS_DigTorqueCommand.bas
- PLSInterrupts.bas

About Kollmorgen

Kollmorgen is a leading provider of motion systems and components for machine builders. Through world-class knowledge in motion, industry-leading quality and deep expertise in linking and integrating standard and custom products, Kollmorgen delivers breakthrough solutions that are unmatched in performance, reliability and ease-of-use, giving machine builders an irrefutable marketplace advantage.

For assistance with your application needs, visit www.kollmorgen.com or contact us at:

North America

KOLLMORGEN

203A West Rock Road
Radford, VA 24141 USA

Internet www.kollmorgen.com

E-Mail support@kollmorgen.com

Tel.: +1 - 540 - 633 - 3545

Fax: +1 - 540 - 639 - 4162

Europe

KOLLMORGEN Europe GmbH

Pempelfurtstraße 1
40880 Ratingen, Germany

Internet www.kollmorgen.com

E-Mail technik@kollmorgen.com

Tel.: +49 - 2102 - 9394 - 0

Fax: +49 - 2102 - 9394 - 3155

Asia

KOLLMORGEN

Rm 2205, Scitech Tower, China
22 Jianguomen Wai Street

Internet www.kollmorgen.com

E-Mail sales.asia@kollmorgen.com

Tel.: +86 - 400 666 1802

Fax: +86 - 10 6515 0263

KOLLMORGEN[®]

Because Motion Matters™