



MOTION TECHNOLOGY DIVISION

110 Fordham Road
Wilmington, MA 01887
(978) 988-9800
Fax (978) 988-9940

Part# 903-522000-03
List Price \$25 U.S.
September, 1997
Rev D

5220

Stepper/Motor Indexer/Drive

Installation and Hardware Reference

Rev D

Table of Contents

1 Overview of 5220	1-1
1.1 5220 Definition	1-1
1.2 System Diagram	1-3
1.3 How to Use this Manual	1-4
1.4 Warranty	1-5
2 Installing the 5220	2-1
2.1 Unpacking and Inspecting the 5220	2-1
2.2 Selecting a Motor	2-2
2.3 5220 Safety	2-2
2.4 Mounting the 5220 in Your Installation	2-4
2.5 Connecting the Four Input/Output Cables	2-6
2.5.1 J3 Motor Connection	2-8
2.5.1.1 4-lead Motor	2-10
2.5.1.2 8-lead Motor, Series Connected	2-11
2.5.1.3 8-lead Motor, Parallel Connected	2-13
2.5.2 J5 Power Supply Connection	2-14
2.5.3 J2 Serial Port Connection	2-16
2.5.3.1 RS-232 Connection	2-18
2.5.4 J1 Discrete Inputs/Outputs Connection	2-20
2.6 Jumper Settings	2-29
2.6.1 E1 and E2 - RS-232 Port Configuration	2-29
2.6.2 E3 - Current Control	2-29
2.6.3 E4 - Step Size Operation	2-30
2.6.4 E5 - Idle Current Control	2-31
2.6.5 E16, E17, E18 - Baud Rate Setting	2-32
2.6.6 Jumper Location	2-33

3	Powering Up the 5220	3-1
3.1	Testing the Installation	3-1
3.1.1	Connections Test	3-1
4	Maintaining/Troubleshooting	4-1
4.1	Maintaining the 5220	4-1
4.2	Troubleshooting the 5220	4-1
4.2.1	POWER LED Not On	4-2
4.2.2	DISABLE FAULT LED On	4-3
4.2.3	5220 Does Not Respond	4-4
	Appendix A Specifications	A-1
	Appendix B Order Number & Ordering Information	B-1
	Appendix C Pinout and Connections Summary	C-1
	Appendix D Jumper Settings	D-1
	Appendix E I/O Summary and Pinouts	E-1
	Appendix F Stepper Motor Basics	F-1
	Appendix G Low Speed Resonance Problems	G-1
	Appendix H Series/Parallel Connection	H-1
	Appendix I Phasing Sequencing	I-1
	Index	

1 Overview of 5220 Indexer/Drive

In this Chapter This chapter introduces the 5220 Indexer/Drive. Topics covered are:

- 5220 definition
- System diagram
- How to use this manual
- Warranty information

1.1 5220 Definition

The Pacific Scientific 5220 Indexer/Drive combines a high performance, bipolar (MOSFET) chopper drive with simple one-letter mnemonic programmable indexer for stepper motor motion control.

5220 Block diagram

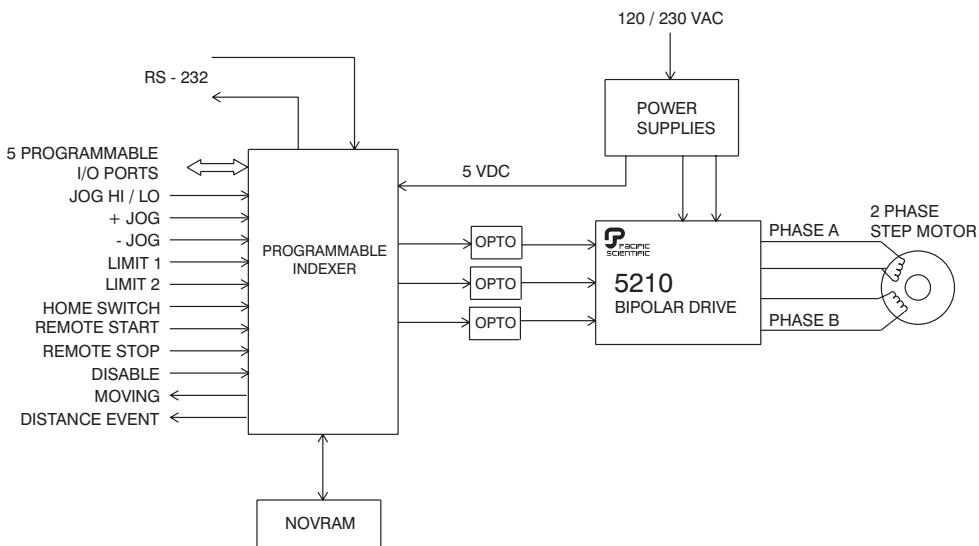

Drive features

Output current - Constant current, 2.5 Amps per phase. 1.25 Amps per phase with idle current reduction active.

Bipolar chopper drive - Full bridge MOSFET, high frequency inaudible 17 KHz PWM chopping drive.

Power supplies - Operates from two or three DC supplies depending if the optical isolation between the indexer and drive is used. The drive requires +5 Vdc logic supply at 150 mA and +12 to 40 Vdc motor supply with a current of 2.5 Amp. The indexer can be powered from a separate, isolated +5 Vdc power supply at 300 mA or from the same +5 Vdc supply used for the drive logic supply. To increase noise immunity and prevent ground loops, the optically isolated connection is recommended so the motor return is not connected to the same return as the RS-232 and discrete I/O returns.

Short circuit protection - Latches the drive off and lights the DISABLE LED if a short circuit occurs on the motor outputs. After removing the short circuit, the DISABLE LED will go off (Reset the 5220 by switching the power OFF and then ON).

Overtemperature - The drive is equipped with an overtemperature shut down detection circuit.

Step size - Sets the amount of rotation per step. There are two settings, full and half step.

Idle current reduction (ICR) - reduces motor windings current by 50% during motor dwell periods. ICR begins 0.1 second after the last input step.

Status indicators - LEDs for operation and troubleshooting information.

Indexer features

The indexer circuit provides programmable motion control and allows flexible interfacing to the application. Features include:

Mnemonic commands - Twenty seven simple one-letter commands used for motion control.

Serial port RS-232 communications - Interfacing with computer or terminal programming and/or computer control (300 to 9600 baud selectable).

Multi axis - Daisy chain allows controlling multiple 5220 controllers through a single host or computer.

Input/Output ports - Five general purpose bi-directional user programmable input/output ports.

Memory - Indexer is made to implement 256 bytes of non-volatile (NV) memory, allowing storage of power-up default parameters and user's program.

1.2 System Diagram

The diagram on the following page shows an installation of the indexer/drive in a typical system. Your system may vary from this configuration. Typical components used with 5220 include:

- Stepper motor
- Computer or terminal
- External switches

System diagram

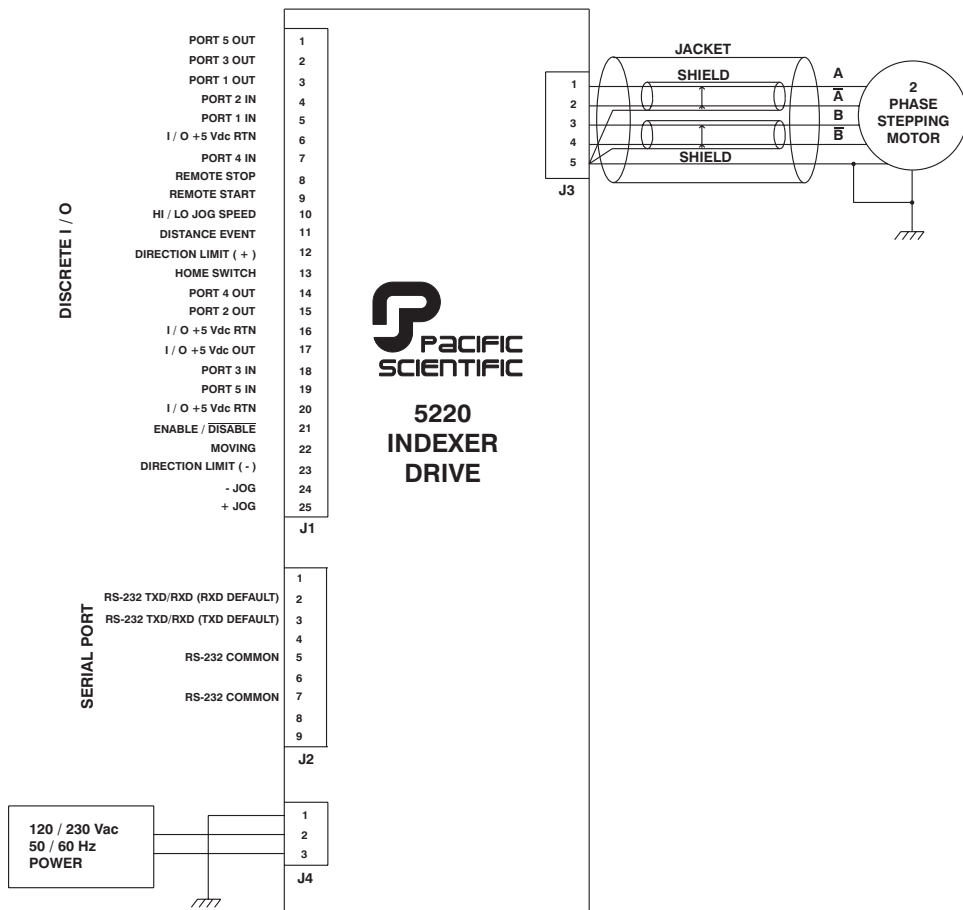

1.3 How to Use This Manual

This manual contains information and procedures to install, set up, test with simple commands and troubleshoot the 5220. Refer to the 5220 Programming Reference Manual for programming instruction and references.

For a quick reference during installation, Refer to Appendix C, “Connections summary”, Appendix D, “Jumper Settings” and Appendix E, “I/O Summary”.

1.4 Warranty

The Pacific Scientific 5220 Indexer/Drive has a two year warranty against defects in material and assembly. Products that have been modified by the customer, physically mishandled or otherwise abused through miswiring, incorrect switch settings and so on, are exempt from the warranty plan.

2 Installing the 5220 Indexer/Drive

In this chapter This chapter explain how to install the 5220 Indexer/Drive. Topics covered are:

- Unpacking and inspecting the 5220
- Selecting a motor
- 5220 safety
- Mounting the 5220 in your installation
- Connecting input/output cabling
- Selecting jumper functions

2.1 Unpacking and Inspecting the 5220

Unpacking procedure

1. Remove the 5220 from the shipping carton. Make sure all packing materials are removed from the unit.
2. Check the items against the packing list. A label located on the side of the unit identifies the unit by model number, serial number and date code.

Inspection procedure

Inspect the unit for any physical damage that may have been sustained during shipment.

If you find damage, either concealed or obvious, contact your buyer to make a claim with the shipper. Do this as soon as possible after receipt of the unit.

Storing the unit

Store the 5220 in a clean, dry place (humidity 10% to 90% non-condensing). The storage temperature must be between -25 to 85 °C.

To prevent damage during storage, place the unit in the original shipping carton.

2.2 Selecting a Motor

The 5220 is designed for use with Pacific Scientific's line of hybrid stepper motors. The drive works with either the standard line or the enhanced high performance line of stepper motors.

The motor winding current rating must be equal to or greater than the output current of the indexer/drive package - 2.5 Amps.

The electrical and magnetic losses of the motor must not exceed the motor power dissipation rating. This is a concern at higher speeds and with low inductance motors. The case temperature should not exceed 100 degrees C.

Refer to the Torque/Speed curves in the Pacific Scientific "Motion Control Solutions" Catalog or contact your local Pacific Scientific distributor for sizing and motor compatibility assistance.

2.3 5220 Safety

Your responsibility

As the user or person applying the unit, you are responsible for determining the suitability of this product for any application you intend. In no event will Pacific Scientific Company be responsible or liable for indirect or consequential damage resulting from the use of this product.

Safety background

To minimize shock hazard, all components should be connected to a common earth point.



Safety guidelines

The internal drive circuitry will vary from 38 volts above to 38 volts below earth ground potential.

Warning

The circuits in the 5220 are a potential source of severe electrical shock. Follow the safety guidelines to avoid shock.

To avoid possible personal injury whenever you are working with the 5220:

- Do not power up the unit without the chassis tied to earth ground.
- Do not operate the unit without the motor case tied to earth ground.
- Do not make any connections to the internal circuitry. The indexer is optically isolated from the drive module. All user I/O circuitry is connected to this board.
- Always remove power before making or removing connections from the unit.
- Allow the unit to sit for five minutes to discharge the bus capacitors when power is turned off.
- Be careful of the motor terminals when disconnected from the motor. With the motor disconnected and power applied to the drive, the motor terminals have high voltage present.
- Do not use the disable input as a safety shutdown. Always remove power to the drive for a safety shutdown.

2.4 Mounting the 5220 in Your Installation

Cabinet selection

Select a standard 8-inch (205 mm) deep NEMA (National Electrical Manufacturers Association) enclosure appropriate for industrial applications.

Caution

The internal cabinet temperature should not exceed 50°C (60°C with derating). If the cabinet is ventilated by filtered or conditioned air make sure to prevent the accumulation of dust and dirt on the unit's electronic components. The air should also be free of corrosive or electrically conductive contaminants.

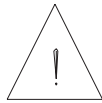

Mounting dimensions

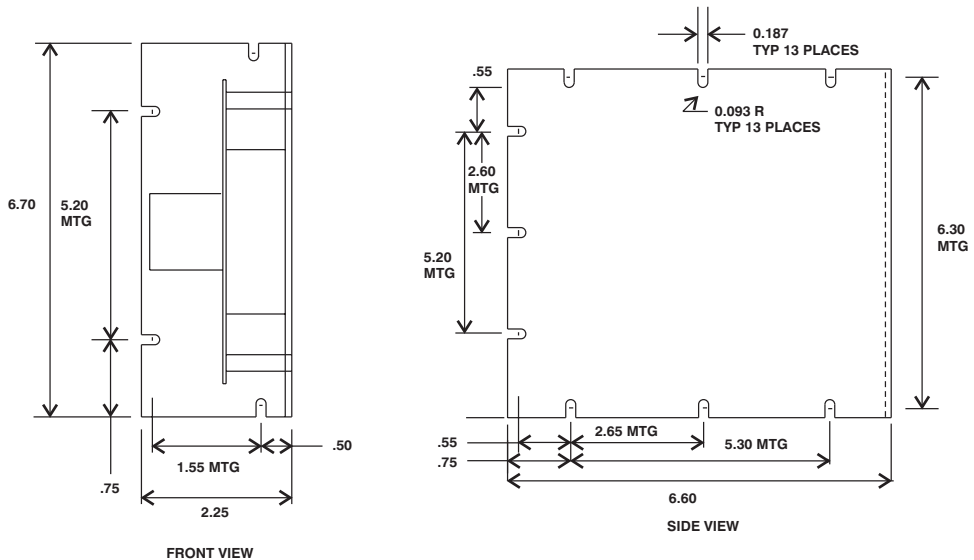

Mounting guidelines

Select a cabinet position that meets these guidelines:

- Flat solid surface capable of supporting the approximate 1.5 lbs (0.70 Kg) weight of the unit.
- Free of excessive vibration or shock.
- Minimum unobstructed space of four inches (100 mm) at the unit bottom, four inches at the exhaust on the unit top and one inch on each side. (The front view is preferred as it allows for greater surface area).
- Operating temperature of:
 - 0 to 50 degrees C at full rated current
 - 0 to 60 degrees C at 2.5 amp current setting with idle current reduction enabled

Mounting procedure

Refer to the dimensions figure and mounting guidelines.

Power dissipation for the cabinet

The 5220 dissipates power causing cabinet heating. Power dissipation is determined by a number of factors, such as output current, motor winding impedance, input step rates, and idle current reduction. The 5220 is factory preset for 2.5 amps/phase current and idle current reduction enabled.

Maximum power dissipation under these conditions is 20 watts. Use this value to determine cabinet cooling requirements.

2.5 Connecting the Four Input/Output Cables

Introduction

The four input/output cables are:

- J3 - Motor
- J5 - Input power
- J2 - RS-232 serial port
- J1 - Discrete inputs and outputs

Connection diagram

These inputs and outputs are shown as follows:

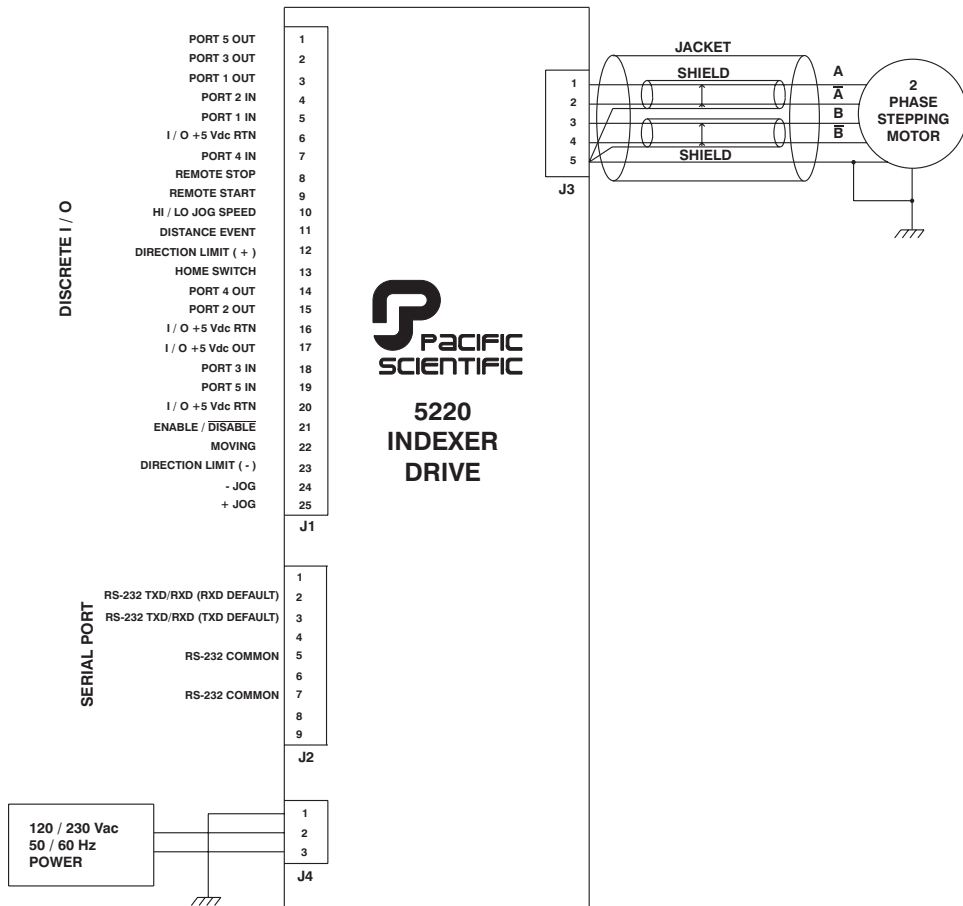

Wiring is application specific



Wiring sizes, wiring practices, and grounding/shielding techniques described in the following section represent common wiring practices and should prove satisfactory in the majority of applications.

Caution

Non-standard applications, local electrical codes, special operating conditions, and system configuration wiring needs take precedence over the information included here. Therefore, you may need to wire the drive differently than described here.

Noise pickup reduction

Power and signal wiring should be routed separately to reduce the possibility of noise pickup. Signal wiring should be shielded. Motor phase wiring should be twisted to reduce radiated noise.

Shock hazard reduction

Refer to section 2.3 for safety information that must be followed to reduce shock hazard.

In this section

To install connector...	Refer to section...
J3	2.5.1
J5	2.5.2
J2	2.5.3
J1	2.5.4

2.5.1 J3 Motor Connection

Introduction The J3 motor cable connects the drive to the motor windings. Motor cables are available from Pacific Scientific, or you can make your own.

Mating connector The J3 motor connector is for a PCD 5-pin screw mating connector. The mating connector, supplied with the unit, is ELFH05110.

Making your own cable If you need to build the cable, refer to the appropriate subsection as follows:

Motor type	Refer to section
4-lead	2.5.1.1
8-lead series	2.5.1.2
8-lead parallel	2.5.1.3

Pacific Scientific cable If the motor cable is purchased from Pacific Scientific, install as follows. The Pacific Scientific order number is SPC-xxx, where “xxx” is the length of the cable in one foot increments up to 50 feet. For example, SPC-050 is a cable 50 feet long.

Pacific Scientific cabling installation

Pacific Scientific cable diagram

If you are using Pacific Scientific motor cable with the mating connectors already attached, install as follows:

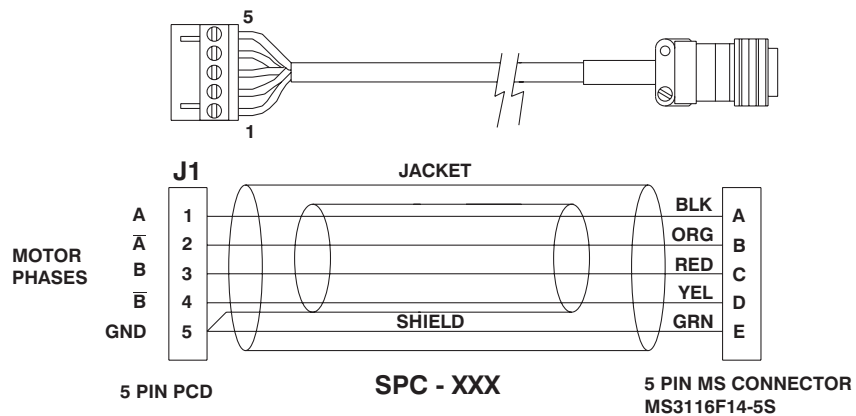

Procedure

1. Remove power from the 5220.

Warning

Always remove power before making or removing connections to the unit. The motor terminals have high voltage present when the 5220 is On.



2. Plug the mating connector firmly into the 5220.
3. Plug the other mating connector into the motor and screw down the retaining collar.
4. Reconnect power to the 5220.

2.5.1.1 4-Lead Motor

Introduction For the 4-lead standard systems motor with MS connector, build and install the cable as follows.

Cable requirements Use 18- to 16-gauge stranded wire for the cabling. Obtain cable with each winding pair (refer to diagram) twisted at about 3 to 4 turns per inch (1 to 1.5 turns per centimeter). Make sure the cable contains a lead for grounding. As an option, the cable may be shielded to reduce radiated noise.

Cabling diagram The colors references in the diagram follow the Pacific Scientific stepper motor color code.

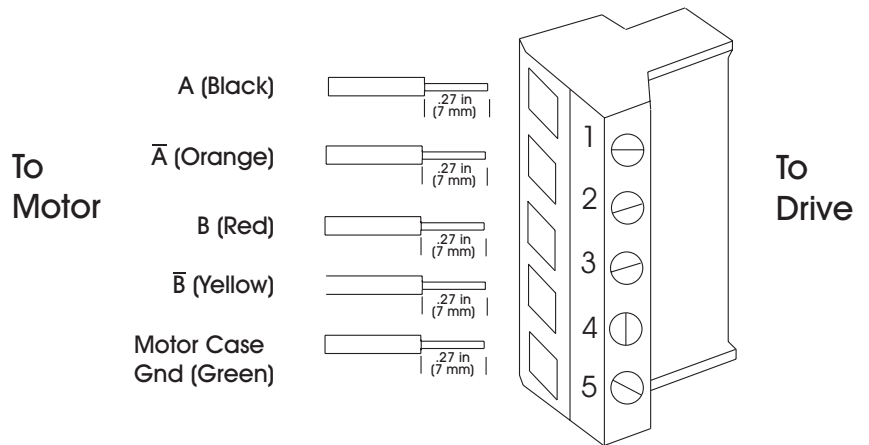

Procedure

1. Strip the wires to 0.27 inch (7 mm).
2. Attach the wire to the connector as indicated in the diagram.

Note: *Make sure the screws on the Phoenix connector are tightened down firmly to the wiring.*

Caution

Do not pre-tin (solder) the tops of the cables going into the Phoenix connector. This can result in a loose connection.

3. Remove power from the 5220.

Warning

Always remove power before making or removing connections to the unit. The motor terminals have high voltage present when the 5220 is On.



4. Plug the mating connector firmly into the 5220.
5. Connect the cable shield to 5220 ground, if applicable.
6. Plug the other mating connector into the motor.
7. Switch On the 5220.

2.5.1.2 8-Lead Motor, Series Connected

Introduction

For an 8-lead motor to be wired in series, build and install the cable as follows.

Note: *For additional information, refer to Appendix H, "Series/Parallel Connections."*

Cable requirements

Use 18- to 16-gauge stranded wire for the cabling. Obtain cable with each winding pair (see diagram) twisted at about 3 to 4 turns per inch (1 to 1.5 turns per centimeter). Make sure the cable contains a lead for grounding. As an option, the cable may be shielded to reduce radiated noise.

Cabling diagram

The colors referenced in the diagram follow the Pacific Scientific stepper motor color code.

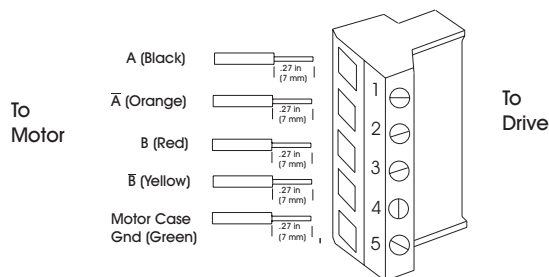

In addition, make the following connections at the motor:



Procedure

1. Strip the wires to 0.27 inch (7 mm).
2. Referring to the diagram, attach the wires to the connector. Connect the white-striped leads with wire nuts as shown.

Note: Make sure the screws on the PCD connector are tightened down firmly on the wiring.

Caution

Do not pre-tin (solder) the tips of the cables going into the PCD connector. This can result in a loose connection.

3. Remove power from the 5220.

Warning

Always remove power before making or removing connections to the unit. The motor terminals have high voltage present when the 5220 is On.

4. Plug the mating connector firmly into the 5220.
5. Connect the cable shield to 5220 ground, if applicable.
6. Plug the other mating connector into the motor.
7. Switch On the 5220.

2.5.1.3 8-Lead Motor, Parallel Connected

Introduction For an 8-lead motor to be wired in parallel, build and install the cable as follows:

Note: For additional information, refer to Appendix H, "Series/Parallel Connections."

Cable requirements Use 18- to 16-gauge stranded wire for the cabling. Obtain cable with each winding pair (see diagram) twisted at about 3 to 4 turns per inch (1 to 1.5 turns per centimeter). Make sure the cable contains a lead for grounding. As an option, the cable may be shielded to reduce radiated noise.

Cabling diagram The colors referenced in the diagram follow the Pacific Scientific stepper motor color code.

Procedure

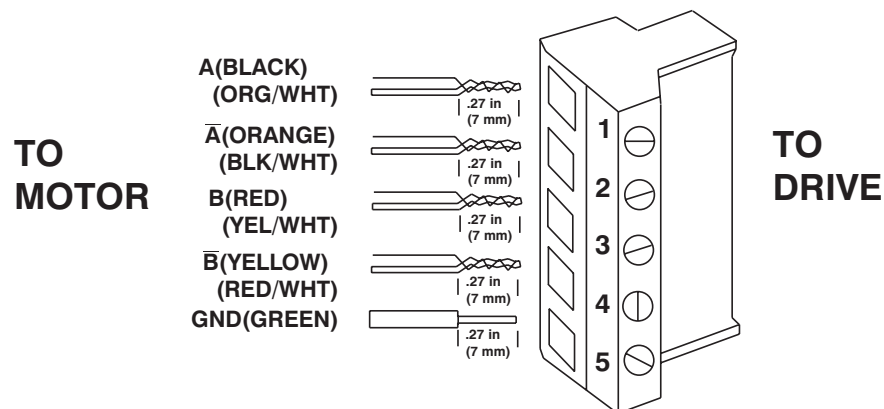

-
1. Strip the wires so that the twisted ends will be the length shown.
 2. Referring to the diagram, twist the striped and solid lead ends and attach the wires to the connector.

Note: Make sure the screws on the PCD connector are tightened down firmly on the wiring.

Caution

Do not pre-tin (solder) the tips of the cables going into the PCD connector. This can result in a loose connection.

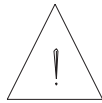

3. Remove power from the 5220.

Warning

Always remove power before making or removing connections to the unit. The motor terminals have high voltage present when the 5220 is On.



2.5.2 J5 Input Power Supply Connection

Mating connector

The J5 input power is for a Phoenix 7-pin screw mating connector. The connector, supplied with the unit, is type MSTB 1.5/7 ST 5 mm.

Power supplies

The drive operates from two or three DC supplies depending on whether the optical isolation between the indexer and drive is used. The drive requires +5 Vdc logic supply at 150 mA and +12 to 40 Vdc motor supply with a current of 2.5 Amp. The indexer can be powered from a separate, isolated +5 Vdc power supply at 300 mA or from the same +5 Vdc supply used for the drive logic supply. One advantage of using the isolated supply is that the motor return is not connected to the same return as the RS-232 source.

Cable requirements

Use 18- to 16-gauge shielded wire for the cabling.

Cabling diagram

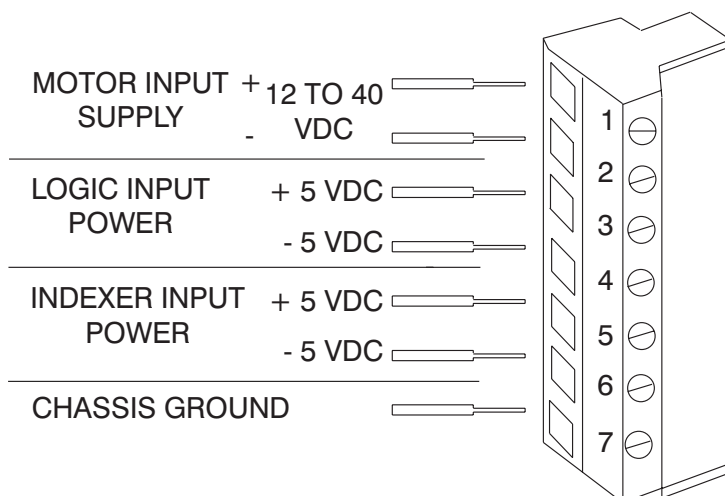

Procedure

1. Strip the wires 0.27 inch (7 mm).
2. Attach the wires to the connector as indicated in the diagram.

Note: Make sure the screws on the Phoenix connector are tightened down firmly on the wiring.

Caution

Do not pre-tin (solder) the tips of the cables going into the Phoenix connector. This can result in a loose connection.

Warning

The chassis ground must be tied to earth ground. Failure to do this leaves the potential for severe hazard. Make sure the ground is connected via the ground stud on the front of the 5220.

3. Plug the mating connector firmly into the 5220.



2.5.3 J2 Serial Port Connection

Introduction

The serial port transmits and receives RS-232 serial communication for the user interface of your unit.

Single- and multi-unit control

You can configure installation to control single or daisy chained 5220s. Interconnection diagrams for both configurations are shown in Section 2.5.3.1, “J2 Serial port - RS-232 Connection”.

Mating connector

The J2 serial port mating connector, supplied with the unit, is an ITT Cannon DE-9P 9-pin plug-in female D connector.

Cable requirements

Use 22-gauge wire for the cabling. As an option, the cable may be shielded to reduce noise pickup.

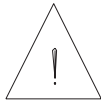

Caution

To avoid ground loops, connect ground shield to indexer ground only.

Port connections

These are the RS-232 transmit (TXD) and receive (RXD) terminals.

Pin Number	Connection
J2-2	RS-232 TXD/RXD
J2-3	RS-232 RXD/TXD
J2-5	RS-232 Common
J2-7	RS-232 Common

Note: *The function of the pins depends upon the jumper settings of E1 and E2.*

The factory default setting is:

J2-2 (RXD), J2-3 (TXD), E1 is set to L-C and E2 set to H-C

Settings

1. **(Default)** Setting E1 jumper in the L-C position and E2 jumper in the H-C position will set:
 - J2-2 = RXD and J2-3 = TXD
2. Setting E1 jumper in the H-C position and E2 jumper in the L-C position will set:
 - J2-2 = TXD and J2-3 = RXD

Baud rate

Baud rate is established by setting jumpers E16, E17 and E18.

There are seven different RS-232 baud rate setting available. These jumpers must be set prior to power up.

Baud Rate	E16	E17	E18
9600	L-C	L-C	L-C
4800	H-C	L-C	L-C
2400	L-C	H-C	L-C
1800	H-C	H-C	L-C
1200	L-C	L-C	H-C
600	H-C	L-C	H-C
300	L-C	H-C	H-C
Illegal	H-C	H-C	H-C

Note: The factory default setting is for 9600 baud, all jumpers in the L-C position. Jumper settings are only read at power up.

Refer to Section 2.7 for jumper location.

2.5.3.1 J2 Serial Port - RS-232 Connection

Introduction Connect the 5220 to your computer or terminal as follows.

- Procedure**
1. Solder the cable leads to the 9-pin connector as shown.
 2. Assemble the connector housing.

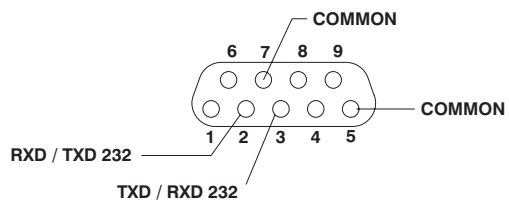

3.

Build the cable to connect to your computer or terminal by referring to the documentation for the device. Standard RS-232 pinouts for IBM compatible personal computers are shown as follows. The 5220 is shipped with J2-2 connected to the RS-232 receiver and the J2-3 to the transmitter. The function of these pins can be interchanged using the E1 and E2 jumper as shown below.

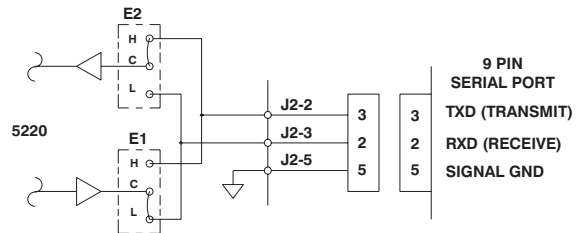
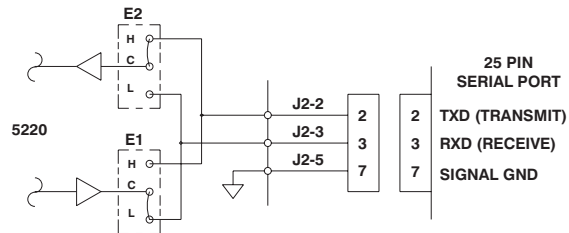

**Procedure
(cont'd)**

Note: *Pinouts vary among computer manufacturers. Check the hardware reference manual for your machine before wiring the serial port.*

4. Plug the connector into the input and affix the connector to the unit with screws.
-

Multiple units

Multiple 5220s can be connected as follows:

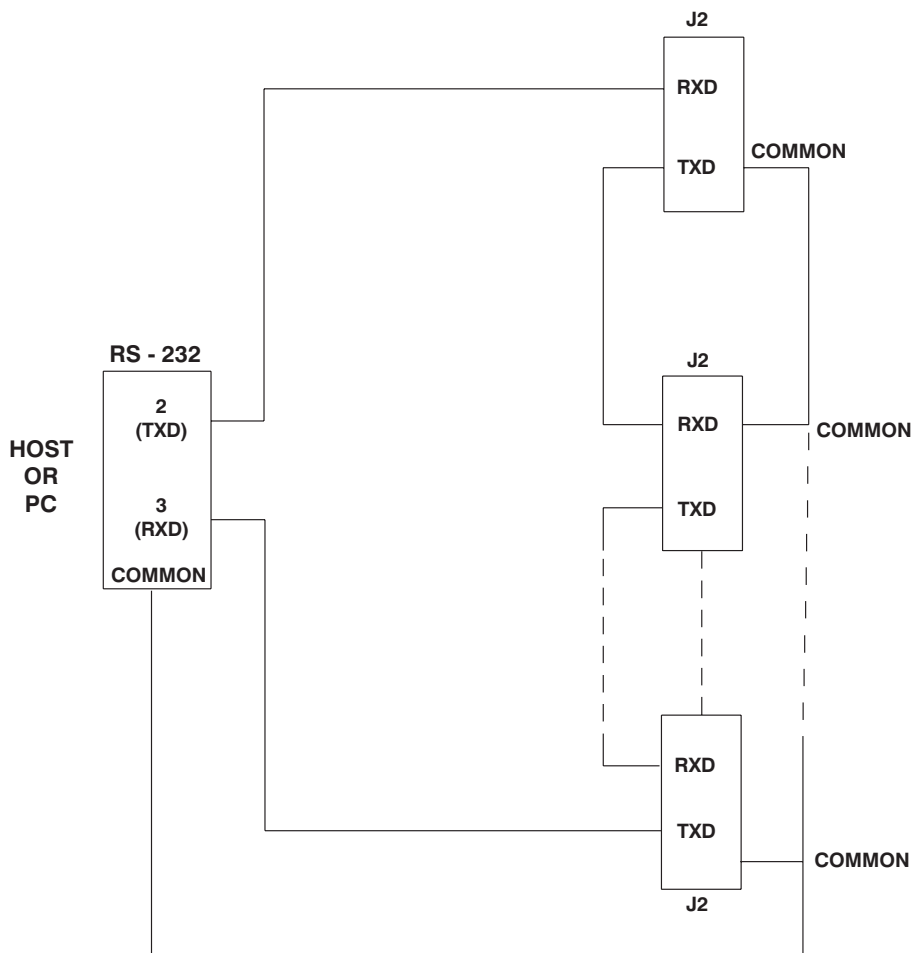

2.5.4 J1 Discrete Inputs/Outputs Connection

Introduction

J1 connector contains all programmable inputs and outputs. There are five user programmable bi-directional I/O ports. **To avoid confusion, it is recommended that each port be used as an input or output only.**

Note: Refer to the **K** and **Y** commands in the programming section.

Port	Pin Number	Command	I/O
Port 1	J1-5	K1	Input 1
	J1-3	Y1	Output 1
Port 2	J1-4	K2	Input 2
	J1-15	Y2	Output 2
Port 3	J1-18	K3	Input 3
	J1-2	Y3	Output 3
Port 4	J1-7	K4	Input 4
	J1-14	Y4	Output 4
Port 5	J1-19	K5	Input 5
	J1-1	Y5	Output 5

- The input ports (K1 through K5) are TTL compatible and have a 10 KW pull-up resistor to +5 Vdc.
- The output ports (Y1 through Y5) are also TTL compatible and with a source capability of 5 mA and a sink capability of 20 mA.

Bi-direction I/O port circuitry

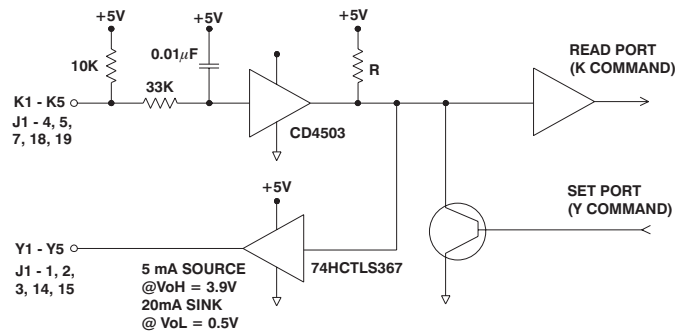

Input/Output	Pin Number	Explanation
I/O +5 Vdc Output	J1-17	The +5 Vdc output is current limited by an internal 47 W resistor. Refer to the I/O power figure below.
I/O +5 Vdc RTN	J1-6	
	J1-16	
	J1-20	

I/O power circuitry

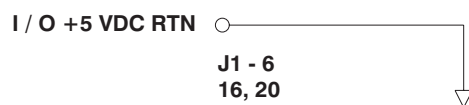
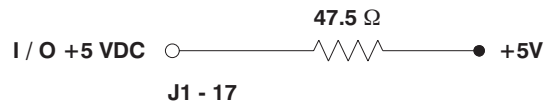

Input/Output	Pin Number	Explanation
HI/LO Jog Speed	J1-10	These inputs are used to jog the stepping motor. The two, JOG speeds (hi or low) are programmable through the (^ 11 hh) command (Refer to the programming section). The selection of the jogging speed depends on the input of JOG HI/LO input. A high (+5 Vdc) input selects the LO speed and a low (0 Vdc) input selects the HI speed. The +JOG and -JOG input causes motor rotation in the appropriate direction when pulled low. These inputs are TTL compatible and are pulled up internally via a 10 KW resistor to +5 Vdc. Refer to Input figure below.
+ JOG	J1-25	
- JOG	J1-24	

Input circuitry

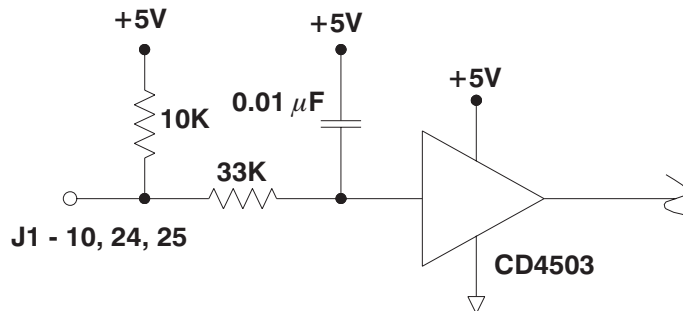

Input/Output	Pin Number	Explanation
Direction LIMIT +	J1-12	These inputs are intended to be used as overtravel limit switches. The motor motion will be ceased in the appropriate direction when either input is forced to a low state. These inputs are TTL compatible and internally pulled up via a 10 KW resistor to +5 Vdc. Refer to the input figure below.
Direction LIMIT -	J1-23	
Home Switch	J1-13	This input provides a mechanical position reference for the indexer (Refer to “H” command in the programming section). This input is TTL compatible and internally pulled up via a 10 KW resistor to +5 Vdc. Refer to the input figure below.

Input circuitry

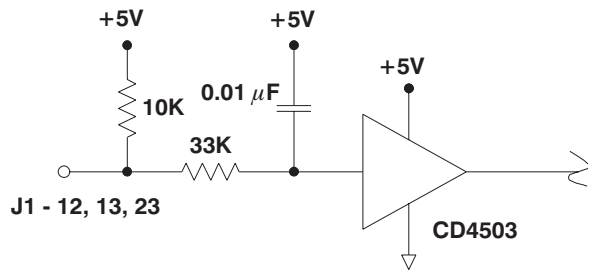

Input/Output	Pin Number	Explanation
Remote Start	J1-9	This input can be used to initiate an execution of a stored program. Forcing this input to a low state (5 msec minimum) will initiate program execution starting at address 0 (Equivalent to G 0 command). This input is TTL compatible and internally pulled via a 10 KW resistor to +5 Vdc. Refer to input figure below.
Remote Stop	J1-8	Forcing this input to a low state (5 msec minimum) while a motion is in progress will cause the motor to decelerate to a stop. If a program is being executed, the program execution will be terminated. This input is equivalent to the "S" command in the COMMAND (immediate) mode. This input is TTL compatible and is pulled internally via a 10 KW resistor to +5 Vdc. Refer to the input figure below.

Input circuitry

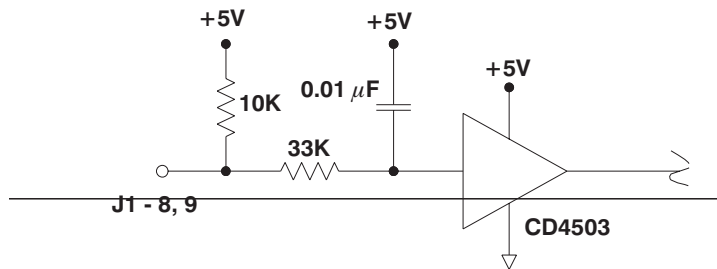

Input/Output	Pin Number	Explanation
Moving	J1-22	This output is forced low while the motor is being commanded to move. If the motor falls out of sync, but is still being commanded to move, this output is still low. The output goes high whenever the motor is not being commanded to move. This output is TTL compatible and has a sourcing capability of 5 mA. Refer to outputs figure below.
Distance Event	J1-11	This output is used as a position trigger indicator. It is a programmable output using the "0" and "Y64" commands (refer to the programming manual). This output is toggled each time the programmed position has passed. This output is TTL compatible and has a sourcing capability of 5 mA and a sinking capability of 20 mA. Refer to the outputs figure below.

Output circuitry

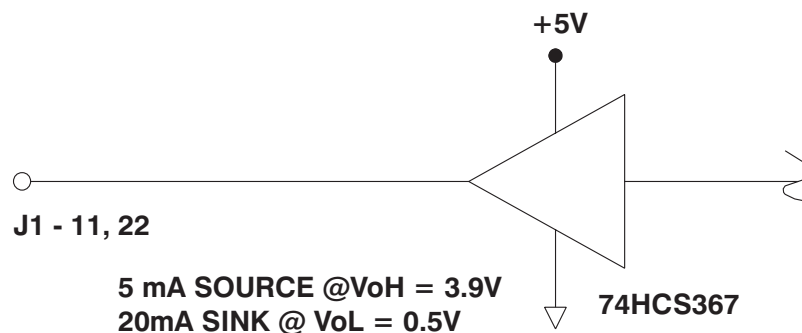

Input/Output	Pin Number	Explanation
Enable/Disable	J1-21	If this output is forced low, the driver will be disabled. In the disabled state, the chopping is disabled and both phase currents go to zero. When the driver is disabled, the indexer is still active and will put out step pulses if it was executing a motion command. The indexer will continue executing the programmed commands. The enable input is TTL compatible and internally pulled up by a 10 KW resistor to +5 Vdc. Refer to the input figure below.

Input circuitry

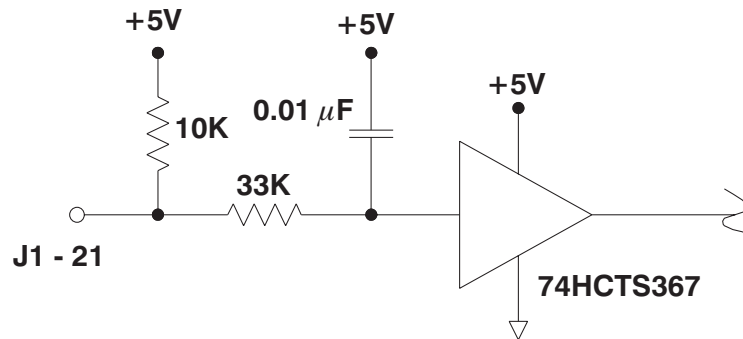

J1 Discrete inputs

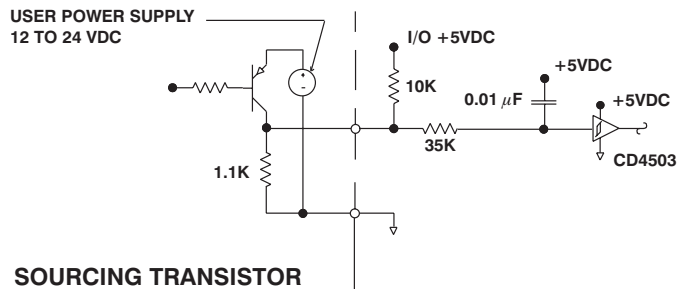
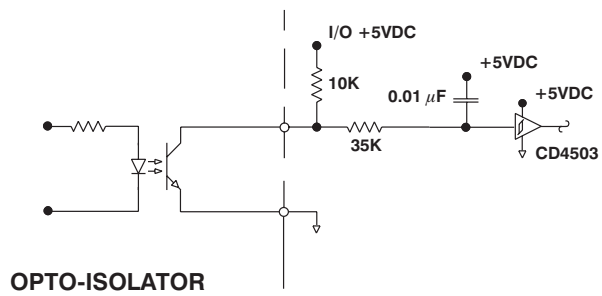
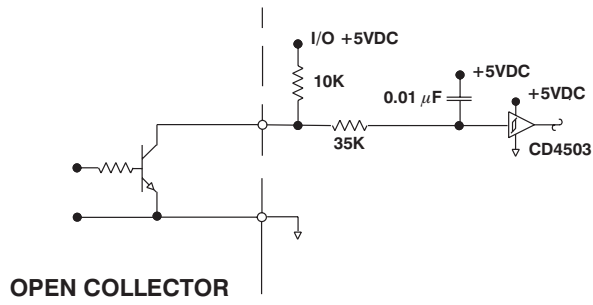
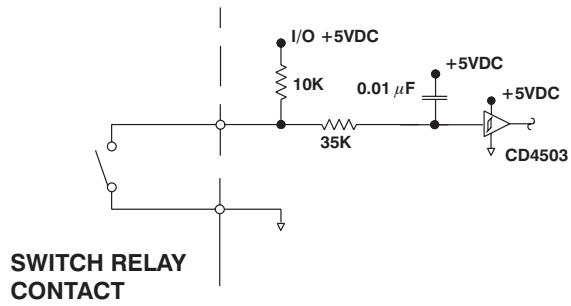

**Y1-Y5
Distance
event -
output
differential
wiring**

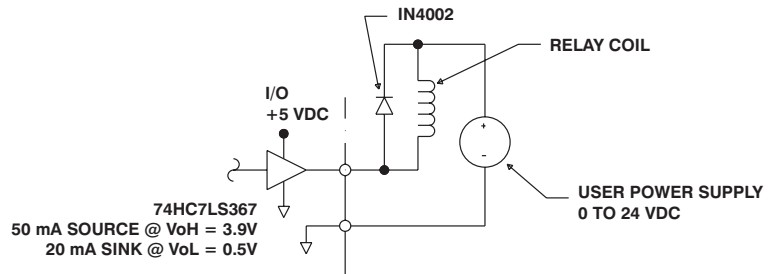

RELAY LOAD

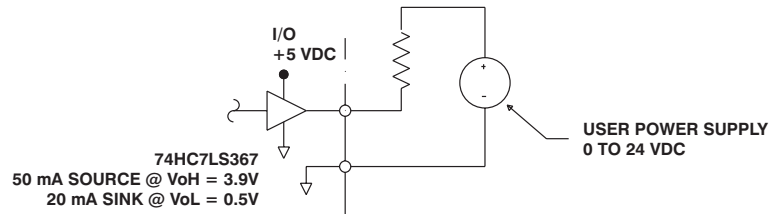

RESISTIVE LOAD

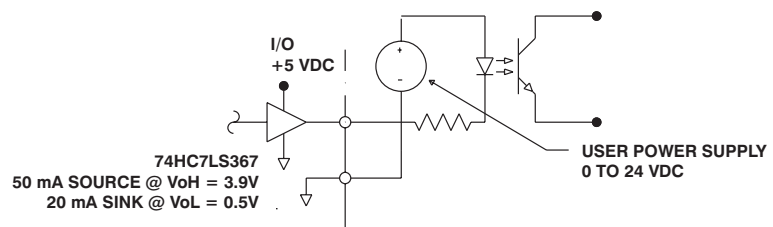

OPTO-ISOLATOR LOAD

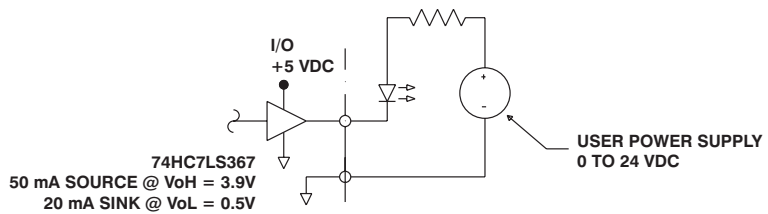

LED INDICATOR LOAD

2.6 Jumper Settings

Selection of different features and options of the 5220 controller depends upon the jumper setting inside the controller. To have access to these jumpers the cover of the unit must be removed. To do this, remove the two screws near the front of the left side and the two screws near the back of the unit and pull the cover forward.



Warning

Dangerous voltages exist inside the unit. Remove power to the unit whenever the cover is removed.

2.6.1 E1 and E2 - RS-232 Port Configuration

These jumpers provide flexibility in adapting different RS-232 cables. Both the input (RXD) and output (TXD) functions can be swapped between J2-2 and J2-3.

Settings

Configuration	E1	E2
J2-2 (TXD), J2-3 (RXD)	H-C	L-C
J2-2 (RXD), J2-3 (TXD)	L-C	H-C

Note: *The factory default setting is:*

- J2-2 (RXD), J2-3 (TXD) E1 set to L-C and E2 set to H-C

2.6.2 E3 - Current Control

The drive has two modes of current control. E3 jumper sets the current mode of the controller.

Settings

Configuration	E3
Recirculating mode	L-C
Non-recirculating mode	H-C

In most applications, recirculation mode is preferred. The power losses in the module and stepping motor are lower in the recirculation mode due to the lower amplitude ripple current. This mode should be used whenever possible.

For some applications, it may be necessary to use the non-recirculation mode. While this mode introduces higher module and motor losses due to higher ripple currents, it reduces the module's sensitivity to back EMF from the motor. This improved back EMF rejection reduces mid-range stability problems. Mid-range stability problems are inherent in any stepping motor system and can cause the motor to fall out of synch due to the parametric oscillation of the motor current resulting in a reduction of torque at mid-range speeds. Using the non-recirculation mode will reduce the systems susceptibility to mid-range instability.

Note: *The factory default setting is for recirculating mode, E3 in L-C position.*

2.6.3 E4 - Step Size Operation

The drive can be configured to FULL or HALF step operation. The step size sets the amount of rotation per input step.

Settings

Step Size	E4
Full step (200 step/rev)	H-C
Half step (400 step/rev)	L-C

Refer to Appendix F, "Stepping Motor Basic", and Appendix I, "Phasing Sequencing" for additional information.

Note: *The factory default setting is for Half step operation, E4 in L-C position.*

2.6.4 E5 - Idle Current Control

If enabled, the driver will reduce the output current to 1.25 Amp *if no motor motion is commanded after 0.1 second.*

Once the motor motion is commanded, the output current will be boosted back to 2.5 Amp. This feature reduces motor heating in idling case.

Settings

Configuration	E5
Idle Current Reduction On	H-C
Idle Current Reduction Off	L-C

Note: The factory default setting is idle current reduction on, E5 in H-C position.

- When ICR is enabled the holding torque generated by the motor is reduced by approximately 50 %.
- When ICR is enabled the motor stiffness around the holding position is reduced by approximately 50%.

2.6.5 E16, E17 and E18 - Baud Rate Setting

There are 7 different RS-232 baud rate settings available. These jumpers must be set prior to power up.

Baud Rate	E16	E17	E18
9600	L-C	L-C	L-C
4800	H-C	L-C	L-C
2400	L-C	H-C	L-C
1800	H-C	H-C	L-C
1200	L-C	L-C	H-C
600	H-C	L-C	H-C
300	L-C	H-C	H-C
Illegal	H-C	H-C	H-C

Note: The factory default setting is for 9600 baud, all jumpers in the L-C position. Jumper settings are only read at power up.

2.6.6 Jumper Location

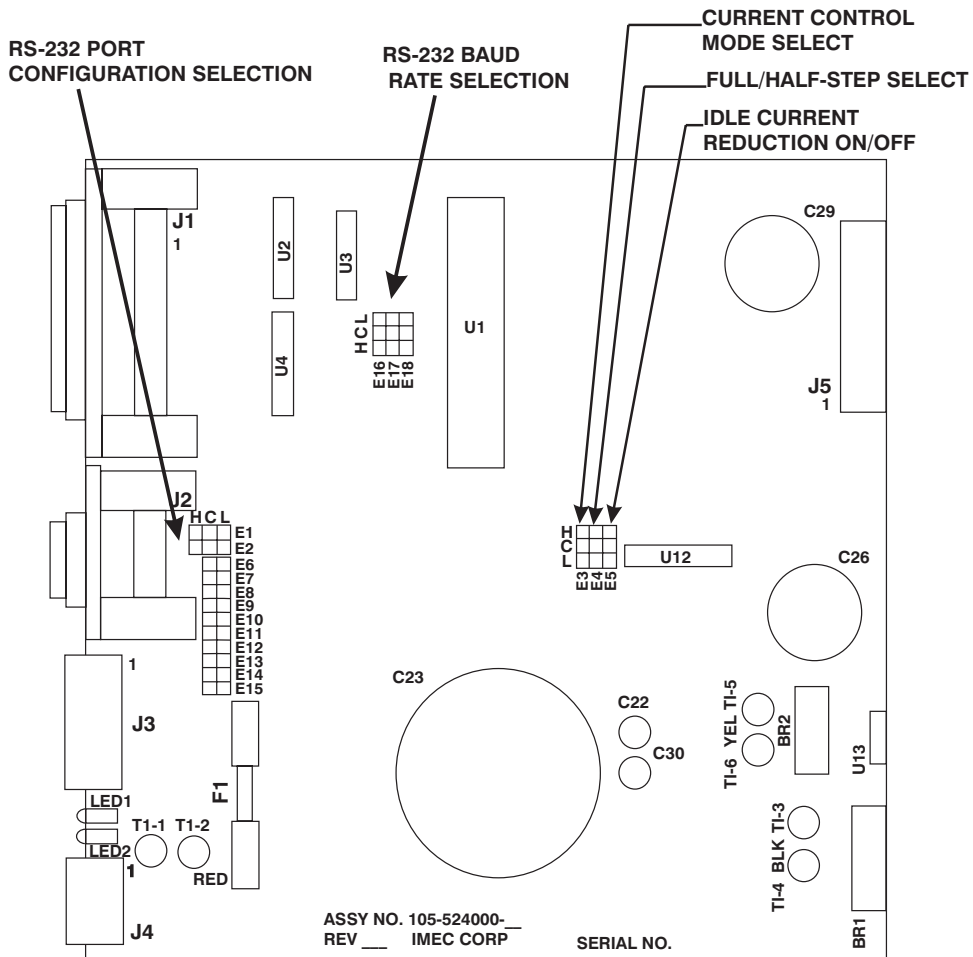

3 Powering up the 5220

In this Chapter This chapter explains how to power up the 5220 after installation.

3.1 Testing the Installation

Background Perform the following test procedure to verify that the 5220 is installed properly and that it was not damaged internally during shipment.

Configuration The installation test power-up procedure requires a motor and computer or terminal to test the basic functionality of the 5220.

Procedure After performing the installation per the guidelines given in Chapter 2, “Installing the 5220”, test your installation as follows.



Warning

Perform this initial power-up with the motor shaft disconnected from the load. Improper wiring or undiscovered shipping damage can result in undesired motor motion. Be prepared to remove power if excessive motion occurs.

3.1.1 Connections test

Introduction Before beginning the connections test, please check the following:

- all wiring and mounting to verify correct installation
- specifications to ensure that voltages being applied do not exceed the voltages specified

Procedure

1. Verify the plug jumper settings are as follows:

Jumper	Setting
E16, E17 and E18	These jumpers should be set to match the baud rate of the terminal or PC being used to communicate with the 5220. Refer to Section 2.5.3.
E1 and E2	These jumpers should be set to the appropriate RS-232 configuration for the terminal and cable being used. Refer to Section 2.5.3.
E5	Set to the H-C position (ICR enabled).
E4	Set to the L-C position (Half step mode).
E3	Set to the L-C position (Recirculating mode).

2. Connect only J5 to the 5220, then apply power
3. Verify that the POWER GREEN LED is the only LED ON. If it is not, refer to Section 4.2, "Troubleshooting".
4. Switch power OFF.
5. Connect the J3 motor connector.
6. Switch power ON again. Check that the POWER GREEN LED is the only LED ON. If so, then motor connection are OK. If not, refer to Section 4.2, "Troubleshooting".

Signals test

1. Verify that the motor has holding torque by attempting to rotate the motor shaft. The energized shaft is either immovable or very resistant to rotation when the drive is enabled.
2. Jog the motor (connect input pin J1-24 or J1-25 to J1-20). The motor moves at the default jog speed.
3. Remove the Jog input.
4. Connect the J2 RS-232 connector. Cycle power to the controller. If using a PC, use the PACCOM disk to setup your PC as a dumb terminal as described in the program reference manual.

5. Send two consecutive space characters. The controller should respond with a pre-defined sign on message:

Sigma products/Pacific Scientific
285-1 v1.06 23

6. From the terminal or computer, type **R1000 <enter>**.
This will move the motor at velocity of 1000 steps per second clockwise.
7. Type **R-1000 <enter>**. This will change the direction of the motor rotation.
8. Type **S <enter>**. The motor should stop rotating.

If the controller passes all of the above, then you may start exercising the unit on your own. If the 5220 does not pass all of the above steps, refer to Section 4.2, "Troubleshooting".

4 Maintaining/Troubleshooting

In this Chapter This chapter covers maintenance and troubleshooting of the 5220 indexer/drive.

4.1 Maintaining the 5220

Introduction The 5220 module is designed for minimum maintenance. The following cleaning procedures performed as needed will minimize problems due to dust and dirt build-up.

Procedures Remove superficial dust and dirt from the module using clean, dry, low-pressure air.

4.2 Troubleshooting the 5220

Introduction The LEDs located on the front panel indicate the controller status and are used for troubleshooting. A table of the LEDs referencing the appropriate section for troubleshooting follows.

LED indicators

When this LED is on	It signifies	Reference section
Power	Connection to logic supply is within operational levels	3.2.1
Disable	Either an external or internal short or internal power supply problem	3.2.2
	Communications interface problem	3.2.3

4.2.1 POWER LED Not On - 5220 does not power up

Procedure

Follow this procedure if the 5220 POWER LED will not light when power is applied:

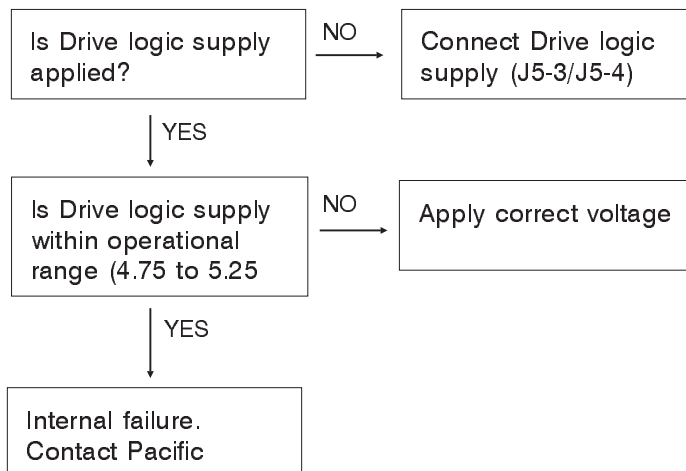

Warning

Do not operate the unit without the chassis tied to earth ground. Contact with energized components causes severe shock or burn.

4.2.2 DISABLE FAULT LED On - 5220 contains power fault

Procedure

Follow this procedure if the 5220 DISABLE FAULT LED lights during operation.

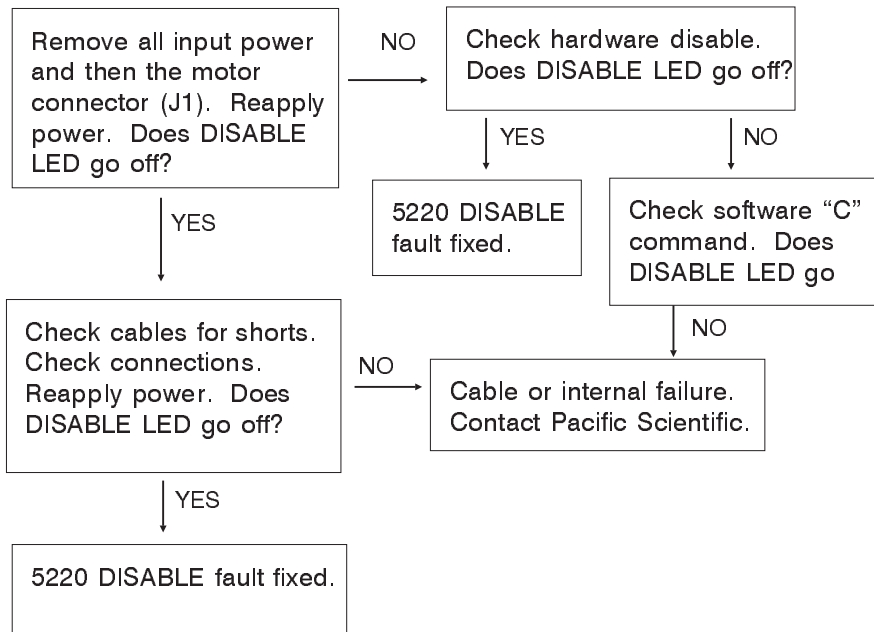

4.2.3 5220 Does Not Respond - Communications interface fault

Procedure

Follow this procedure if the terminal does not communicate with the indexer/drive.

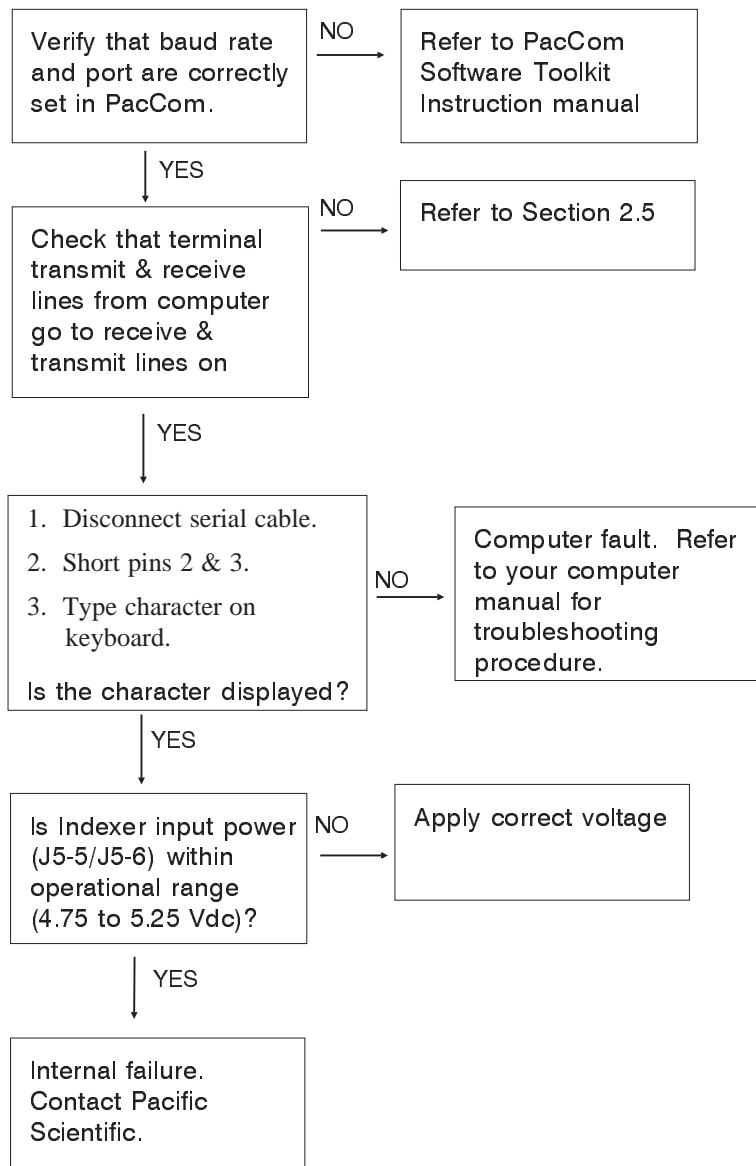

If 5220 is defective

If you cannot correct the problem, return the module to Pacific Scientific for replacement.

Return procedure

1. Call Pacific Scientific at (978) 988-9800 from 8 am to 6 pm Eastern Standard Time to receive a Returned Materials Authorization Number (RMA#).

Note: *Do not attempt to return the stepper drive or any other equipment without a valid RMA#. Returns received without a valid RMA# will not be accepted and will be returned to the sender.*

2. Pack the drive in its original shipping carton. Pacific Scientific is not responsible or liable for damage resulting from improper packaging or shipment.

3. Ship the stepper drive to:

Pacific Scientific
Motion Technology Division
110 Fordham Road
Wilmington, MA 01887
Attn: Repair Department, RMA# _____

Note: *Do not ship Pacific Scientific motors to the above address. The correct address for motors is:*

Pacific Scientific
Motor Products Division
4301 Kishwaukee Street
Rockford, IL 61105
Attn: Stepper Repair Department, RMA# _____

Shipment of your drive or motor to Pacific Scientific constitutes authorization to repair the unit. Refer to Pacific Scientific's repair policy for standard repair charges. Your repaired unit will be shipped via UPS ground delivery. If another means of shipping is desired, please specify this at the time of receiving an RMA#.

Appendix A Specifications

Electrical

Input voltages and current	Drive Logic Supply	+5 \pm .25 Vdc	150 mA
	Drive Motor Supply	+12 to 40 Vdc	2.5 Amp
	Indexer Logic Supply	+5 \pm .25 Vdc	300 mA

Fuse AGX4 on the motor power supply

Drive circuit Two-phase bipolar, chopper current regulated

Bus voltage +12 to 40 Vdc fused input

Rated current 2.5 Amp RMS nominal

Step size	<u>Jumper selectable</u>	<u>Steps/motor (1.8 ° stepper motor)</u>
	Full	200
	1/2	400

Chopper frequency 17 kHz, nominal

Maximum pulse rate 10000 steps/sec

Environmental

Operating temperature	0 to 50 degrees C at full rated current 0 to 60 degrees C 2.5 Amp RMS with idle current reduction enabled
Storage temperature	-25 to 85 degrees C
Humidity	10 to 90%, noncondensing
Altitude	5,000 feet (1500 meters)

Mechanical

For an estimate of the power dissipation for use in cabinet cooling requirements, assume 20 watts power dissipation in the 5220.

Dimensions	Refer to Section 2.4
Weight	1.5 lbs (approximately 0.7 Kg)

Appendix B Order Number & Ordering Information

Background

This appendix lists the 5220 part numbers and gives information on ordering.

5220 part number table

Part	Order Number	Comment
Indexer/Drive	5220	
Connector kit	106-522000-01	25-pin D connector
		9-pin D connector
		7-pin Phoenix
		5-pin PCD
Installation Manual	903-522000-03	
Programming Manual	903-524000-02	
Pacom disk	904-000201-01	
Pacom manual	903-000201-01	
Motor cable	SPC-xxx	xxx represents length in feet; for example, SPC-005 is a cable 5 feet long. For lengths over 50 feet, contact Pacific Scientific. The connectors are MS on the motor end and PCD on the drive end.



How to order	Contact Pacific Scientific to order these parts.
Call	978-988-9800 from 8 am to 6 pm Eastern Standard Time.
Fax	978-988-9940
Write	Pacific Scientific Motion Technology Division 110 Fordham Road Wilmington, MA 01887

Appendix C Pin Out and Connections Summary

Introduction

This appendix gives pinouts and summarizes the J1 to J4 connections that are covered in-depth in Section 2.5, “Connecting the Input/Output Cabling”.

J3 - Motor connector

The J3 motor connector is connected in one of three ways, determined by the lead wiring from the motor.

4-lead

For four lead wiring to the 5-pin connector, wire as follows:

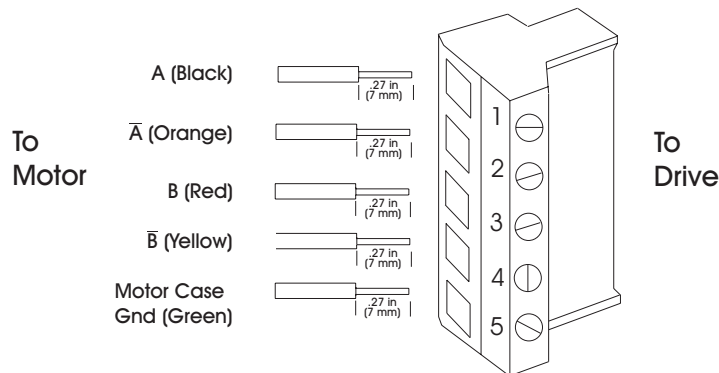

8-lead series

For eight-lead series wiring to the 5-pin connector, wire as follows:

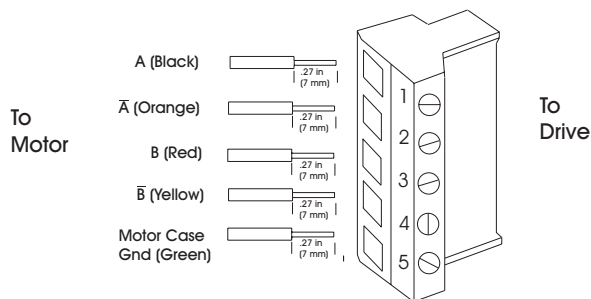

In addition, make the following connections at the motor:



8-lead parallel

For eight-lead parallel wiring to the 5-pin connector, wire as follows:

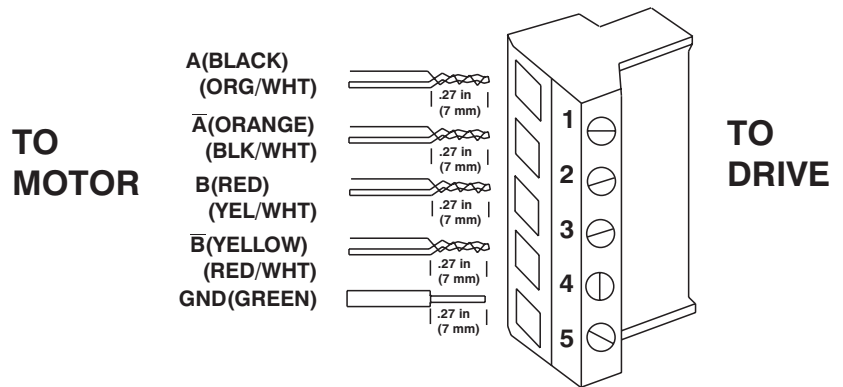

J5 Power supply

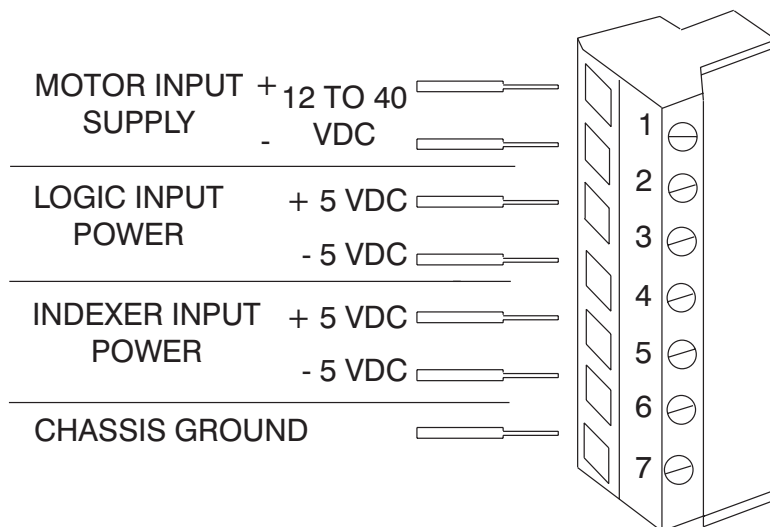

**J2 - Serial port
RS-232**

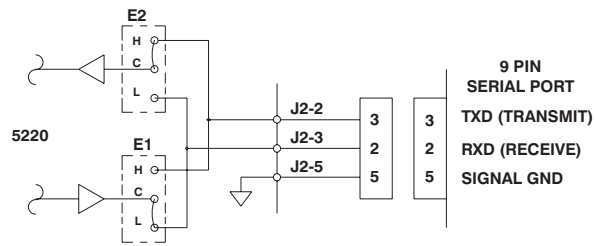
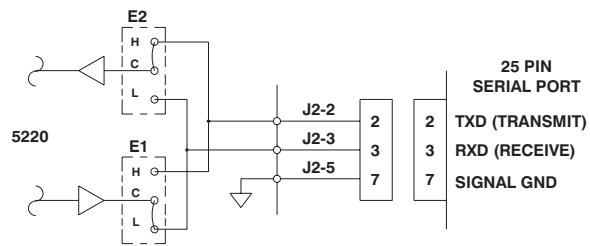

**Multiple units
- daisy
chained**

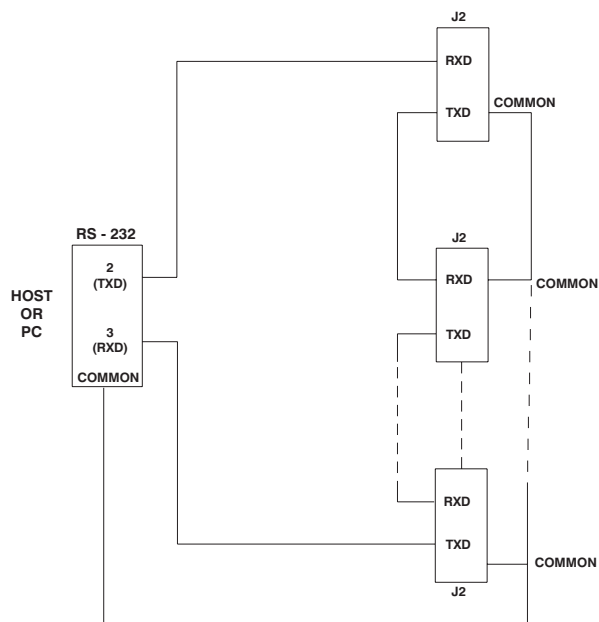

**J1 Discrete
I/O**

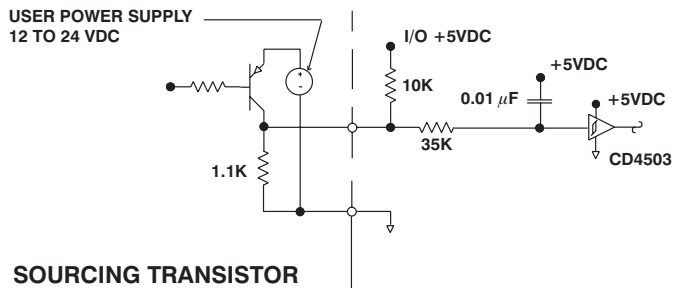
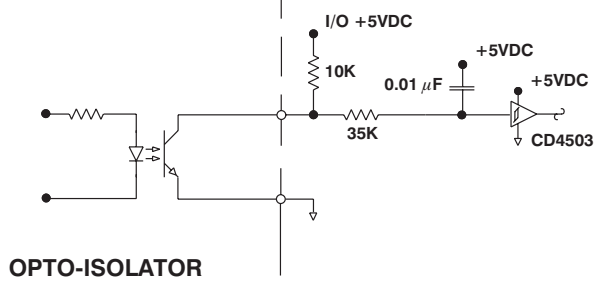
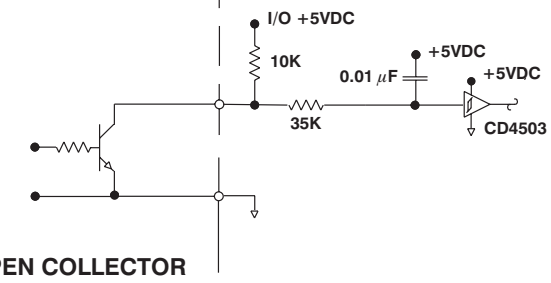
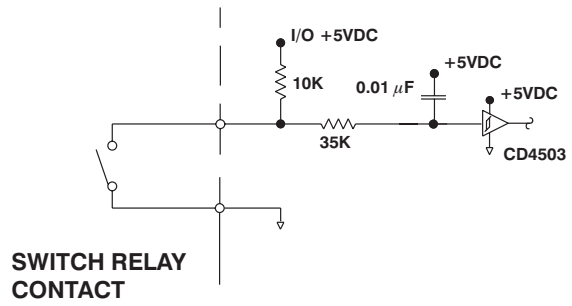

J1 Discrete I/O (cont.)

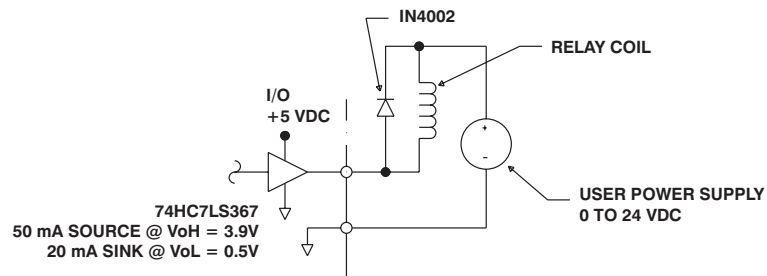

RELAY LOAD

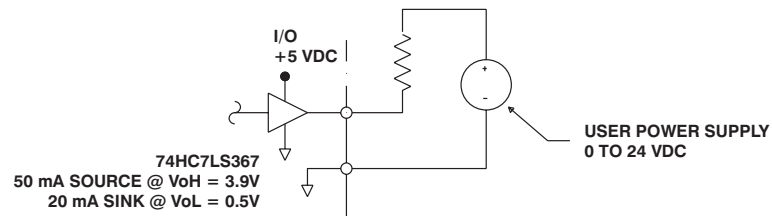

RESISTIVE LOAD

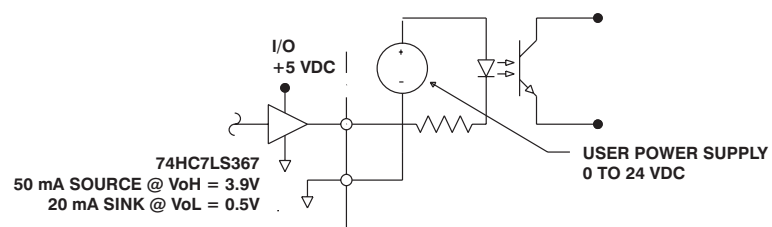

OPTO-ISOLATOR LOAD

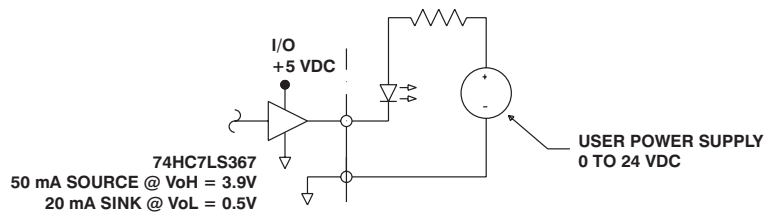

LED INDICATOR LOAD

Appendix D Jumper Settings

Introduction This appendix provides a summary of jumper settings.

E1 and E2 E1 and E2 are used to set RS-232 configuration.

Configuration	E1	E2
J2-2 (TXD), J2-3 (RXD)	H-C	L-C
J2-2 (RXD), J2-3 (TXD)	L-C	H-C

E3 E3 is used to set the current control.

Current Control	E3
Recirculating mode	L-C
Non-recirculating mode	H-C

E4 E4 is used to set step size.

Step Size	E4
Full step operation	H-C
Half step operation	L-C

E5 E5 is used to set idle current control.

Idle Current Control	E5
Idle current reduction On	H-C
Idle current reduction Off	L-C

**E16, E17, and
E18**

These jumpers are used to set baud rate.

Baud Rate	E16	E17	E18
9600	L-C	L-C	L-C
4800	H-C	L-C	L-C
2400	L-C	H-C	L-C
1800	H-C	H-C	L-C
1200	L-C	L-C	H-C
600	H-C	L-C	H-C
300	L-C	H-C	H-C
Illegal	H-C	H-C	H-C

Note: *These jumper settings are read only at power up.*

Jumper locations

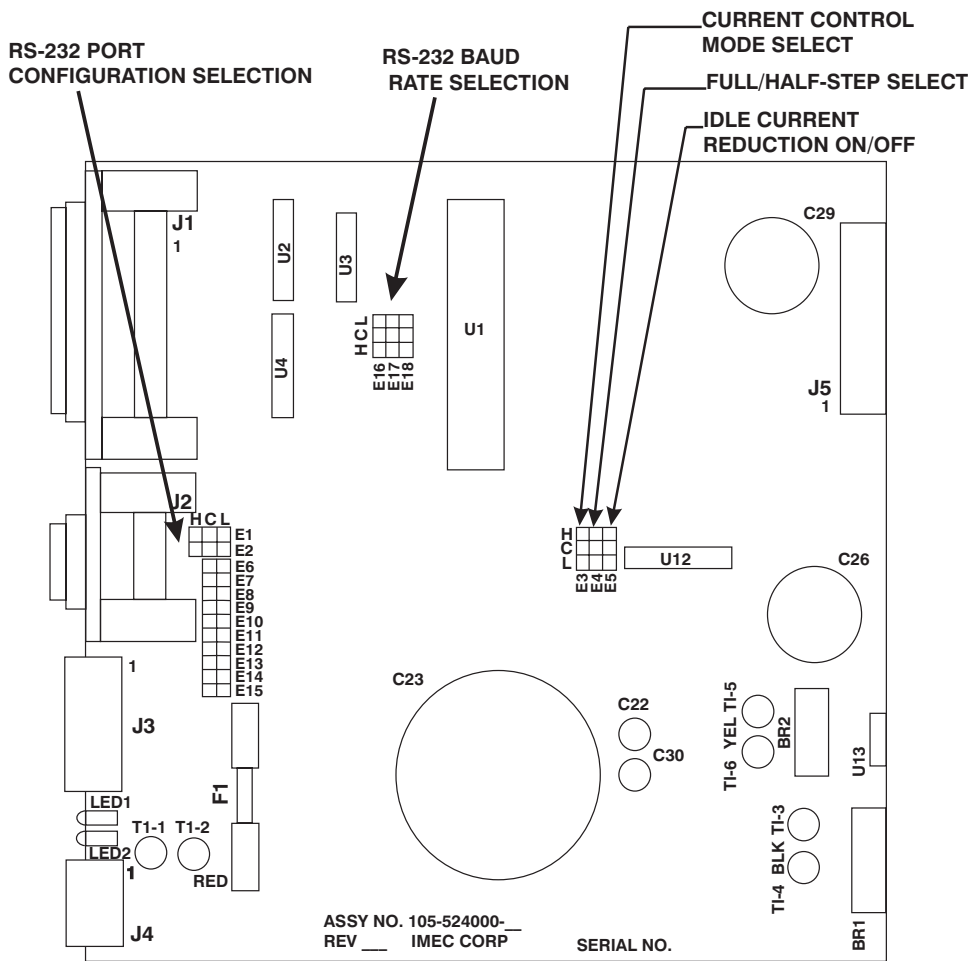

Appendix E I/O Summary & Pinouts

J1 (I/O interface)

Pinout	Description
J1-1	Port 5 Out
J1-2	Port 3 Out
J1-3	Port 1 Out
J1-4	Port 2 In
J1-5	Port 1 In
J1-6	I/O +5 Vdc Rtn
J1-7	Port 4 In
J1-8	Remote Stop
J1-9	Remote Start
J1-10	Hi/Lo Jog Speed
J1-11	Distance Event
J1-12	Direction Limit (+)
J1-13	Home Switch
J1-14	Port 4 Out
J1-15	Port 2 Out
J1-16	I/O +5 Vdc Rtn
J1-17	I/O +5 Vdc Output
J1-18	Port 3 In
J1-19	Port 5 In
J1-20	I/O +5 Vdc Rtn
J1-21	Enable/Disable
J1-22	Moving
J1-23	Direction Limit (-)
J1-24	- JOG
J1-25	+ JOG

**J2 RS-232
Interface**

Pinout	Description
J2-5	RS-232 Common
J2-7	RS-232 Common
J2-2	TXD or RXD
J2-3	RXD or TXD

Note: All other pins on J2 are not connected.

J3 Motor

Pinout	Description
J3-1	Motor Phase A
J3-2	Motor Phase \bar{A}
J3-3	Motor Phase B
J3-4	Motor Phase \bar{B}
J3-5	Motor Ground

**J5 Power
Supply**

Pinout	Description
J5-1 (+)	Drive motor input
J5-2 (-)	12 to 40 Vdc at 2.5 Amp
J5-3 (+)	Drive logic input power
J5-4 (-)	+5 \pm .25 Vdc at 150 mA
J5-5 (+)	Indexer input power
J5-6 (-)	+5 \pm .25 Vdc at 300 mA
J5-7	Frame ground

Appendix F Stepper Motor Basics

Hybrid stepping motor

A hybrid stepping motor can be simplified to the diagram shown below:

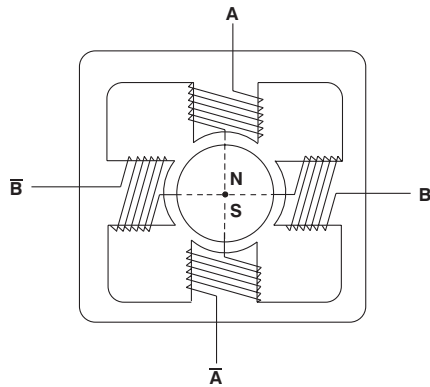

The stator consists of two-phase windings and the rotor is a permanent magnet. The rotor aligns itself with the magnetic field created by the stator windings. By controlling the winding currents in the proper sequence, torque is produced and the rotor will rotate in the desired manner. The phase currents are bidirectional and sequencing of these phase currents is termed commutation. There are three basic types of stepping motor commutation possible with the 5240 module.

- One-phase-on Drive or Wave Drive
- Full-step Drive
- Half-step Drive

One-Phase-On Drive or Wave Drive

In this type of commutation, only one phase of the stepping motor is on at any given time. Phases are energized in the following sequence.

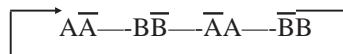

Note: $A\bar{A}$ means that the phase current is flowing from A to \bar{A} .

The figure below shows the commutation sequence for clockwise rotation of a stepping motor with wave drive commutation. The rotor is simplified to a bar magnet with North and South poles. This type of commutation is typically not used since Full-step drive provides equivalent step resolution with 1.4 times more torque.

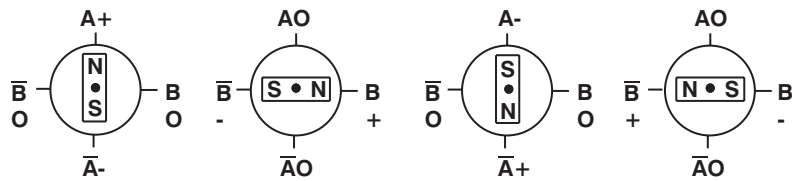

This type of commutation is selected by applying power to the module with the HALF/FULL input high or unconnected. This will set the module for Half-step operation starting in the Zero state. Input one pulse into the STEP input. This will force the outputs to one of the Wave Drive commutation states. Now, force the HALF/FULL input into the low state. The module will be set for Wave Drive operation. The Full-step wave drive mode can be set with the output disabled (enable line pulled low) so that the motor will not move during wave drive selection.

Note: Do NOT change the state of the HALF/FULL input state during operation since the Full-step or Wave Drive mode is selected based upon the state of the module outputs when the HALF/FULL input is pulled low.

Full-Step Drive

In this type of commutation, both stepping motor phases are energized at all times. The commutation sequence is:

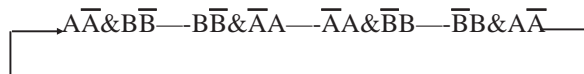

The following figure shows this commutation sequence for clockwise motor rotation.

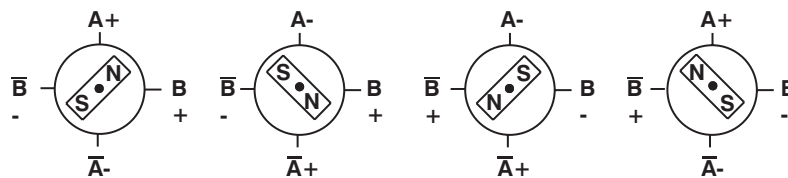

This type of commutation is selected by forcing the HALF/FULL input low prior to applying power to the module and keeping the input low. The module is now set for Full-step operation. Do NOT change the state of the HALF/FULL input state during operation since the Full-step or Wave drive mode is selected based upon the state of the module outputs when the HALF/FULL input is pulled low.

Half-Step Drive

This type of commutation alternates between one phase energized and two phases energized. This halves the step size (doubles step resolution) but gives irregular torque. The torque with two phases energized is 1.4 times higher than that produced with one phase energized. The commutation sequence is:

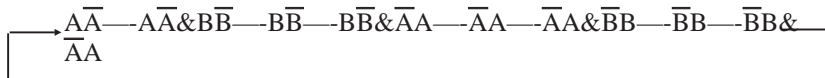

The figure below shows the half-step drive sequence.

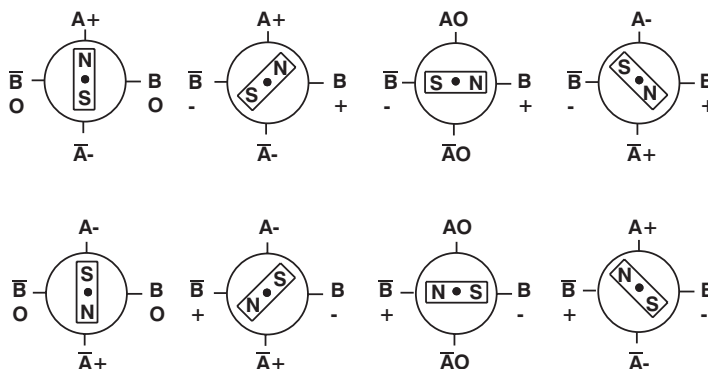

This type of commutation is selected by forcing the HALF/ $\overline{\text{FULL}}$ input high or leaving it unconnected when applying power to the drive. Do NOT change the state of the HALF/ $\overline{\text{FULL}}$ input state during operation since the Full-step or Wave Drive mode is selected based upon the state of the module outputs when the HALF/ $\overline{\text{FULL}}$ input is pulled low.

Note: *All figures are simplified and show a stepping motor with a 90° full-step or 45° half-step commutation. Pacific Scientific stepping motors are designed with a 1.8° full-step or 0.9° half-step commutation.*

Appendix G Low Speed Resonance Problems

A stepper motor is a rotary spring-mass system. The "mass" is the motor's rotor inertia plus any load inertia. The "spring" is the torque produced by the motor which, for small deflections, is proportional to the angle between the actual and commanded positions. If the shaft of the motor is displaced from its holding position by a small angle and then suddenly released, it will swing back and forth around the holding position in a gradually decaying oscillation before eventually coming to rest. As with any lightly damped resonant system, a stepper motor can be made to oscillate at its natural (or resonant) frequency if it is excited by torque pulses occurring at this rate. This will happen if the step rate equals the resonant frequency.

The resonant frequency of a stepper motor having 200 full steps per revolution is given by:

$$F_{\text{resonant}}(\text{hz}) = 1.1 * \text{SQR}(\text{Holding Torque} / J_{\text{total}})$$

where Holding Torque is given in oz-in and J_{total} is the motor plus load inertia in oz-in-sec². For example, the resonant frequency of an unloaded E34HCHT-LNK-NS-00 motor, having rotor inertia equal to 0.035 oz-in and holding torque of 1222 oz-in at 5 amps phase current is :

$$F_{\text{resonant}} = 1.1 * \text{SQR}(1222 / .035) = 206 \text{ Hz}$$

If the motor were run at 206 full steps per second (62 rpm), the resonance will be excited. If the oscillations become large enough, the motor will drop out of synch and stall.

Using the 5220, (with 36 Vdc motor input supply), the solution to the resonance problem is to avoid running the motor near the speed that will excite the resonance frequency. This is easily accomplished by setting the maximum start speed above the speed that excites the resonance.

Appendix H Series/Parallel Connections

Introduction

Several motor connections are possible when using a bipolar drive.

- 8-lead motor
- 6-lead motor
- 4-lead motor

The various connection schemes produce different torque/speed characteristics. They also affect the current rating in the motor.

8-lead motor

The 8-lead motor is the most versatile configuration. It can be connected by the user in either an 8-lead, 4-lead (series or parallel) or 6-lead configuration.

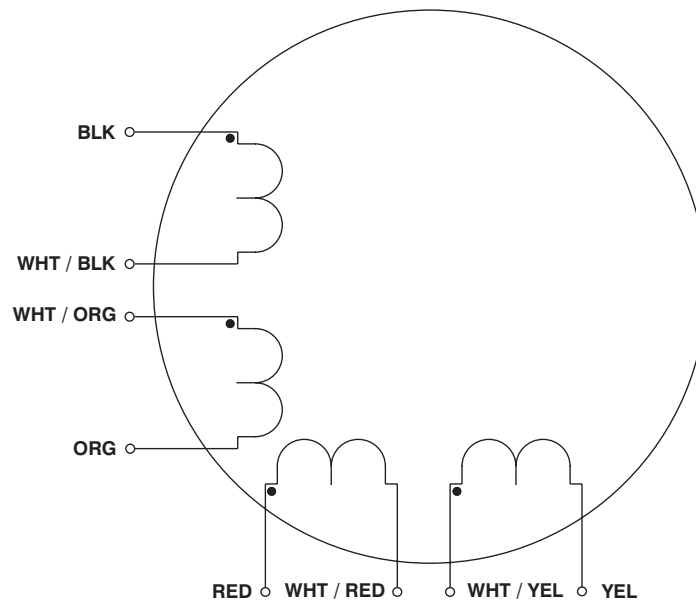

**Connection
table**

Refer to the table below for detailed connection information.

Connection	Terminal #	Lead Color	Drive Connection
4-lead bipolar series	1	Black (Blk)	A
	3	Orange (Org)	\overline{A}
	2	Red	B
	4	Yellow (Yel)	\overline{B}
	6 & 5	Wht/Blk & Wht/Org	
	7 & 8	Wht/Red & Wht/Yel	
4-lead bipolar parallel	1 & 5	Blk & Wht/Org	A
	3 & 6	Org & Wht/Blk	\overline{A}
	2 & 7	Red & Wht/Yel	B
	4 & 8	Yel & Wht/Red	\overline{B}
6-lead unipolar	1	Black (Blk)	A
	3	Orange (Org)	\overline{A}
	2	Red	B
	4	Yellow (Yel)	\overline{B}
	6 & 5	Wht/Blk & Wht/Org	none
	7 & 8	Wht/Red & Wht/Yel	none

6-lead motor

The 6-lead motor is normally used with unipolar drives. In some cases, the 6-lead motor can be used in a 4-lead series configuration for use with bipolar drives.

Connection table

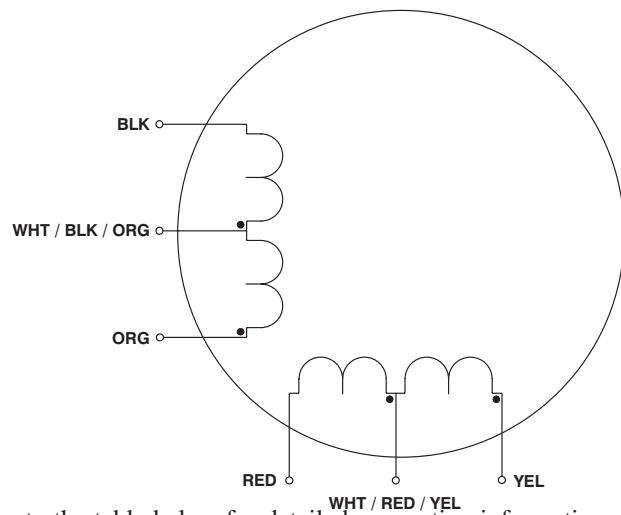

Refer to the table below for detailed connection information.

Connection	Terminal #	Lead Color	Drive Connection
6-lead unipolar	1	Black (Blk)	A
	3	Orange (Org)	\overline{A}
	2	Red	B
	4	Yellow (Yel)	\overline{B}
	5	Wht/Blk/Org	open
	6	Wht/Red/Yel	open

Connection	Terminal #	Lead Color	Drive Connection
4-lead bipolar series	1	Black (Blk)	A
	3	Orange (Org)	\bar{A}
	2	Red	B
	4	Yellow (Yel)	\bar{B}
	5	Wht/Blk/Org	None
	6	Wht/Red/Yel	None

Note: Terminals 7 and 8 are not used.

4-lead motor

The 4-lead motor is for use only with bipolar drives.

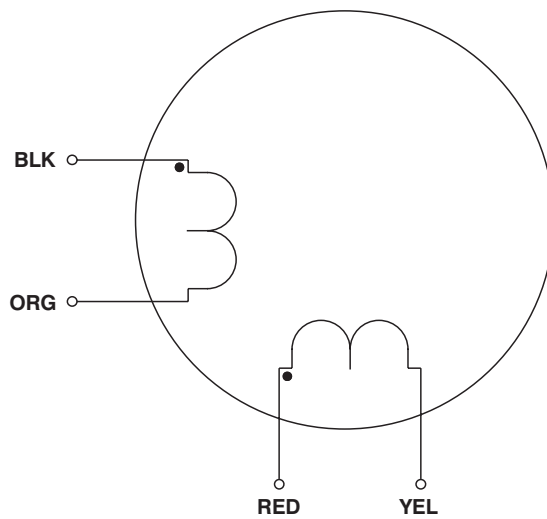

Connection table

Refer to the table below for detailed connection information.

Connection	Terminal #	Lead Color	Drive Connection
4-lead bipolar	1	Black (Blk)	A
	2	Orange (Org)	\bar{A}
	3	Red	B
	4	Yellow (Yel)	\bar{B}

Note: Terminals 5, 6, 7 and 8 are not used.

Winding Connections

Series

Connecting both halves in series results in the drive current flowing through twice as many turns compared with using one half-winding only. For identical currents, this doubles the “amp-turn” and produces a corresponding increase in torque. In practice, the torque increase is seldom 100% due to the non-linearity of the magnetic material. Equally, the same torque will be produced at half the drive current when the windings are in series.

Doubling the effective number of turns in the windings means that the inductance increases by a factor of four. This causes the torque to drop off much more rapidly as speed increases. As a result, the series mode is only useful at low speeds. The maximum shaft power obtainable in series is typically half that available in parallel using the same current setting on the drive.

Conversely, connecting the windings in series will double the total resistance and the current rating is reduced by a factor of 1.4. This provides a safe current of 3.5 amps for a 50 amp motor series.

Parallel



Winding can be connected in parallel is either an 8-lead motor or 6-lead motor.

8-lead

Connecting the two half-windings of an 8-lead motor in parallel allows the current to divide itself between the two coils. It does not change the effective number of turns and therefore the inductance remains the same. At a given drive current, the torque characteristics will be the same for the two half-windings in parallel as it is for one of the windings on its own.

Connecting the windings of an 8-lead motor in parallel has the same effect as halving the total resistance. For the same power dissipation in the motor, the current may now be increased by 40%. Therefore, the 5 amp motor will accept 7 amps with the winding in parallel. This provides a significant increase in the available torque.

6-lead

“Parallel” in a 6-lead motor refers to the use of one half-winding only. The current rating of a stepper motor is determined by allowable temperature rise. Unless the motor manufacturer’s data states otherwise, the rating is a “unipolar” value and assumes both phases of the motor are energized simultaneously. Therefore, a current of 5 amps means that the motor will accept 5 amps flowing in each half-winding.

Summary

As a general rule, parallel connection is preferred over the other options. It produces a flatter torque curve and greater shaft power. Series connection is useful when a high torque is required at low speeds. It allows the motor to produce full torque at low speeds from lower current drives.

Care should be taken to avoid overheating the motor using series connection since its current rating is lower in this mode. Series connection also carries a greater likelihood of resonance problems due to high torque produced in the low speed region.

Appendix I Phasing Sequencing

Introduction

This appendix provides information on phase sequencing for the following set ups:

- Bipolar half-step
- Bipolar full-step

Use the following key to interpret sequence tables:

Phase Sequencing Key	
0	Off or Open
+	Current in to winding
-	Current out of winding

Bipolar Half-step

The table below shows phase sequencing for bipolar half-step motors.

Step	A	\bar{A}	B	\bar{B}
1	+	-	0	0
2	+	-	+	-
3	0	0	+	-
4	-	+	+	-
5	-	+	0	0
6	-	+	-	+
7	0	0	-	+
8	+	-	-	+

CW ↓

↑ CCW

**Bipolar
Full-step**

The table below shows phase sequencing for bipolar full-step motors.

Step	A	\bar{A}	B	\bar{B}
1	+	-	-	+
2	-	+	-	+
3	-	+	+	-
4	+	-	+	-
1	+	-	-	+

CW ↓

↑ CCW

5220 Index

A

Address, 4-5
Altitude, A-2

B

Baud rate, 2-17, 2-32
Block diagram, 1-1
Bus voltage, A-1

C

Cabling
 PacSci, diagram, 2-9
Case temperature, 2-2
Chopper frequency, A-1
Cleaning unit, 4-1
Communications
 interface fault, 4-4
Commutation, F-1
Connections
 diagram, 2-6
 motor, H-1
 multiple units, 2-19
 summary, C-1
 test, 3-1
Configuration
 E1, E2, 2-29
Current
 control, E3, 2-29

D

Daisy chain, 2-19, C-3
Damage, 2-1
Date code, 2-1
Defective unit, 4-5
Definition, 1-1
Description, 1-1
Dimensions
 mounting, 2-4
Direction, LIMIT +, 2-23
Direction, LIMIT -, 2-23
Discrete inputs, J1, 2-27
Dissipation, power, 2-5
Distance event, 2-25
DISABLE FAULT LED, on, 4-3

E

Enable/Disable, 2-26
External switches, 1-3

F

Features, 1-2
Frequency, chopper, A-1
Fuses, A-1

G

Getting help, 2-2

H

Help, getting, 2-2
HI/LO Jog speed, 2-22
Home switch, 2-23
Humidity, A-2

I

Idle current control, 1,2, 2-31
Input,
 current, A-1
 voltage, A-1
Inspection, 2-1
Installation, 2-1
Interface fault, 4-4
I/O
 cables, 2-6
 discrete, connection, 2-20
 summary, E-1

J

+ Jog, 2-22
- Jog, 2-22
J1 connection, 2-20
J2
 serial port connection, 2-16
 RS-232 connection, 2-18
J3 connection, 2-8
J5 connection, 2-14
Jumper location, 2-33, D-3
Jumper settings, D-1, 2-17, 2-29
 E1, E2 configuration, 2-29

E3, current control, 2-29
E-4, stepsize operation, 2-30
E-5, Idle current control, 2-31

K

K command, 2-20

L

LED indicators, 4-1
Low speed resonance, G-1

M

Maintenance, 4-1
Motor
 4-lead, 2-10
 8-lead, serial connection, 2-11
 8-lead, parallel connection, 2-12
Motor basics, stepper, F-1
Mounting,
 dimensions, 2-4
Moving, 2-25
Multi-axis, 1-3
Multiple units, 2-19

O

Operating temperature, A-2
Ordering information, B-2
Order number, B-1
Output, current, 1-2
Overview, 1-1

P

- Pacific Scientific cabling, 2-9
- Packing list, 2-1
- Parallel connection, H-1
- Phase sequencing, I-1
- Pinout summary, C-1, E-1
- Port connections, 2-16
- Power dissipation, 2-5
- POWER LED, not on, 4-2
- Power supply, 2-14, A-1, E-2
- Power up, 3-1
- Protection, short circuit, 1-2
- Pulse rate, A-1

R

- Remote start, 2-24
- Remote stop, 2-24
- Returns, 4-5
- RMA, 4-5

S

- Safety, 2-2
- Sequencing, phase, I-1
- Serial port connection, 2-16
- Serial number, 2-1
- Series connection, H-1
- Short circuit protection, 1-2
- Signals test, 3-3
- Specifications, A-1
- Step Size, A-1
 - operation, 2-30
- Stepper motor basics, F-1
- Storage temperature, 2-1, A-2
- Storing unit, 2-1

- System diagram, 1-4

T

- Temperature, A-2
- Test
 - connections, 3-1
 - signals, 3-3
- Troubleshooting, 4-1

U

- Unpacking, 2-1

V

- Voltage, input , A-1

W

- Warranty, 1-5

Y

- Y command, 2-20