

Kollmorgen Brushless Motor Amplifier EB-10X Series Motors Installation and Service Manual

Edition: October 8, 2020, Revision B
Part Number: EB-9301
Original Document



For safe and proper use, follow these instructions. Keep for future use.

Record of Document Revisions

Revision	Date	Remarks
1		Initial Release
2	10/2004	Update corporate identity, contact information
B	10/2020	Rebrand, CE and Declaration of Conformity removed

IMPORTANT NOTICE

Copyright© Kollmorgen™ 1990 – 2020. All rights reserved.

Technical changes which improve the performance of the device may be made without prior notice!

This document is the intellectual property of Kollmorgen. All rights reserved. No part of this work may be reproduced in any form (by photocopying, microfilm or any other method) or stored, processed, copied or distributed by electronic means without the written permission of Kollmorgen.

SAFETY – READ ALL INSTRUCTIONS BEFORE INSTALLING THIS MOTOR

WARNING

Dangerous voltages exist in this equipment. Do not attempt connecting or probing this equipment with power on.

The fold back feature must limit the over current to no more that 300% of rated current for a maximum period of 8 seconds.

CAUTION

Do not install the amplifier in a hazardous (classified) location unless the amplifier is listed for such location. The motor is U.L. listed for class I, C, and D, but the amplifier might not be suitable for such locations.

Do not operate the motor outside the parameters shown on the respective performance curve.

Do not service unless the area is known to be non-hazardous. Keep covers tight while circuits are live.

Connect internal thermostat to limit motor surface temperature.

Instructions are provided indicating that motor thermostat is an automatic resetting device.

NOTE

Upon receipt of the equipment, closely inspect the components to ensure that no damage has occurred in shipment. If damage has occurred, notify the appropriate carrier at once.

Save these instructions for future reference. Should any question arise regarding any step outlined in this manual, please call the factory.

Proprietary Information of the Kollmorgen Corporation is furnished for customer user only. No other uses are authorized without written permission of Kollmorgen.

1	INTRODUCTION	5
1.1	Amplifier and Power Supply Ratings.....	6
2	WIRING	7
2.1	Typical Amplifier	8
2.1.1	Outline Dimensions	8
2.1.2	Front View	9
2.1.3	Side View	9
2.2	Typical Power Supply.....	10
2.2.1	Outline Dimensions	10
2.2.2	Front View	11
2.2.3	Side View	11
2.3	System Wiring	12
2.4	Typical Motor Connections	14
2.5	3-Phase Power Trans	15
2.6	Grounding	17
2.7	Inputs	17
2.8	Preliminary Checks	17
2.8.1	Checking AC Input Voltage.....	17
2.8.2	Checking the Typical Power Supply DC Output Voltage	17
2.8.3	Zero System Resolver.....	18
3.	MOTOR DATA PACKAGE	19
3.1	EB-10X.....	19
3.1.1	Model Number System	19
3.1.2	EB-10X-11-B2R102	20
3.2	EB-102	21
3.2.1	Specifications CD-27131	21
3.2.2	Performance Curves	23
3.3	EB-104	24
3.3.1	Specifications CD-27132	24
3.3.2	Performance Curves	26
3.4	EB-106	28
3.4.1	Specifications CD 27133.....	28
3.4.2	Performance Curves	30
3.5	EB-60x Typical Current and Voltage (Wave forms at Motor).....	32
3.5.1	Current Phase C	32
3.5.2	Voltage line A-C	32
3.6	Intermittent Duty Operation.....	33

4	TYPICAL AMPLIFIER DATA PACKAGE.....	37
	4.1 Typical Amplifier Specifications	37
5	INDEX.....	38

1 INTRODUCTION

This installation and service manual is a general document and is applicable to a typical amplifier needed to properly control the EB-10X motor series. However, since these motor amplifiers are interfaced with motors of varying sizes having different operating characteristics such as internal resistance, inductance, rotor inertia, etc., these amplifiers vary with the motors with which they are compatible. Consult the manufacturer of the amplifier for the installation and service manual pertaining to the specific amplifier used. After the typical amplifier and a motor are connected, the motor must perform per the motor's nameplate data.

The customer data (CD) and performance curve (PC) are specified documents and are applicable only to individual motors. They contain such information as maximum operating speed, peak current limits, and values, which make the amplifier motor combination compatible. Do not operate the motor outside the parameters shown on the respective performance curves.

Typical amplifiers are of the 3-phase sine wave, pulse-width modulated type. They are full regenerative four-quadrant bi-directional velocity loop amplifiers designed to be used with Kollmorgen's high-performance permanent magnet brushless motors.

An unregulated 300 VDC bus, derived from full-wave rectification of a 3-phase 230 AC line by the power supply unit, is used to power the motor amplifier.

Kollmorgen brushless motors feature the latest in permanent magnet technology, utilizing high energy Samarium-Cobalt and Neodymium-Iron-Boron alloys. These brushless motors consist of permanent magnet rotors and 3-phase Y-stator windings. Brushless motors have no commutators or associated brushes. These motors run as synchronous motors, meaning the rotor speed is the same as the speed (frequency) of the rotating stator magnetic field. A brushless resolver is utilized as the feedback device and is mounted internally as part of the overall motor construction.

Benefits of the typical amplifier and brushless motor construction are:

- Lower rotor inertia allows higher acceleration rates.
- The motor is thermally more efficient since all heat is generated in the stator windings, which are in the outside shell.
- Higher speed operation and high peak horsepower are achieved. There is no commutation limit.
- Smaller physical motor size for a given HP rating.
- Higher reliability and less motor maintenance. There is no commutator or brushes.
- Smooth output torque.

1.1 Amplifier and Power Supply Ratings

Ratings		
Input Power:	235 V _{RMS} (L-L) 3-phase (±10%); isolation transformer not required – provided short circuit (inrush) current remains limited to less than 1000 amps. 115 VAC 1-phase control power.	
Output Power	Power Supply DC Bus	325 VDC nominal, no load
	Amplifier: at rated load	230 VRMS (L-L), Nominal ±10%
	Continuous Current (ARMS/Phase)	Intermittent Current (5 sec. max., 30% duty cycle) (ARMS/Phase)
	As required to produce motors rated current	200% of continuous
Ambient Operating Temperature:	0-55° C	
Switching Frequency	10 kHz	
Cooling	Fan, convection (cold plate)	

2 WIRING

NOTE

Install this motor and typical amplifier per the national electrical code.

To adhere to suitable engineering practices, connect the 115 VAC circuit so the 115 VAC is applied first to activate the control and fault circuits before applying the main bus voltage. Provide over-current protection, based on continuous rated current, per article 430 of the NEC. If possible, adjust the amplifier accordingly. Otherwise, provide external protection.

The method of connecting the motor is by way of flying leads; where the leads of the 3-phase motor stator are color coded and are available directly out of the motor.

Connect the motor with flying leads, where the leads of the 3-phase motor stator are color-coded and available directly out of the motor. See the wiring diagrams for the correct method of wiring the motor stator. Connect the BROWN, RED, and WHITE leads to the points identified as M_a, M_b, and M_c on the power terminal block. Connect the green/yellow lead to the ground point of the ground point of the same terminal block.

Bring the 3-phase 230 input power should be brought through a customer supplied circuit breaker and connected to points identified as L_a, L_b and L_c on the power terminal block mounted on the power supply. The system is not AC line phase sensitive. Connect the 325 VDC output, the 115 VAC, and the regeneration circuit from the power supply to the amplifier with the strapping bars and the small 115 VAC and regen cable. Check to ensure that the small cable is connected to the correct pins and that it is not offset to one side, and do the following:

1. Wire the typical amplifier control terminal strips per the diagram. Dress the wiring neatly so it does not to interfere with remounting the cover.
2. Unplug the C1, C2 and C3 point terminal strips from their connectors on the amplifier-motor control board. This will prevent over flexing the board when wiring up the connectors.
3. After unplugging the terminal strips from the motor control board, wire them per the appropriate diagram.
4. Neatly dress the wire cable so that it enters the amplifier chassis and does not interfere with the front cover. Dress signal cables separately and not with the AC or power wiring.
5. Leave sufficient length in the wiring to allow the motor control board to slide out enough to expose the small compensation board. Insert the wired terminal strips back onto their connectors.

The following precautions are also recommended:

1. Twist all AC leads to minimize electromagnetic emissions and pick-up. Maintain shield over resolver leads.
2. Avoid running signal leads in close proximity to power leads, armature leads or other sources of electromagnetic noise.
3. Minimize lead lengths as much as practical.
4. Double-check all interface wiring. Carefully inspect all connections.
5. Do not use main contactor for control functions.

CAUTION

Motor and resolver phasing are critical for proper operation.

2.1 Typical Amplifier

2.1.1 Outline Dimensions

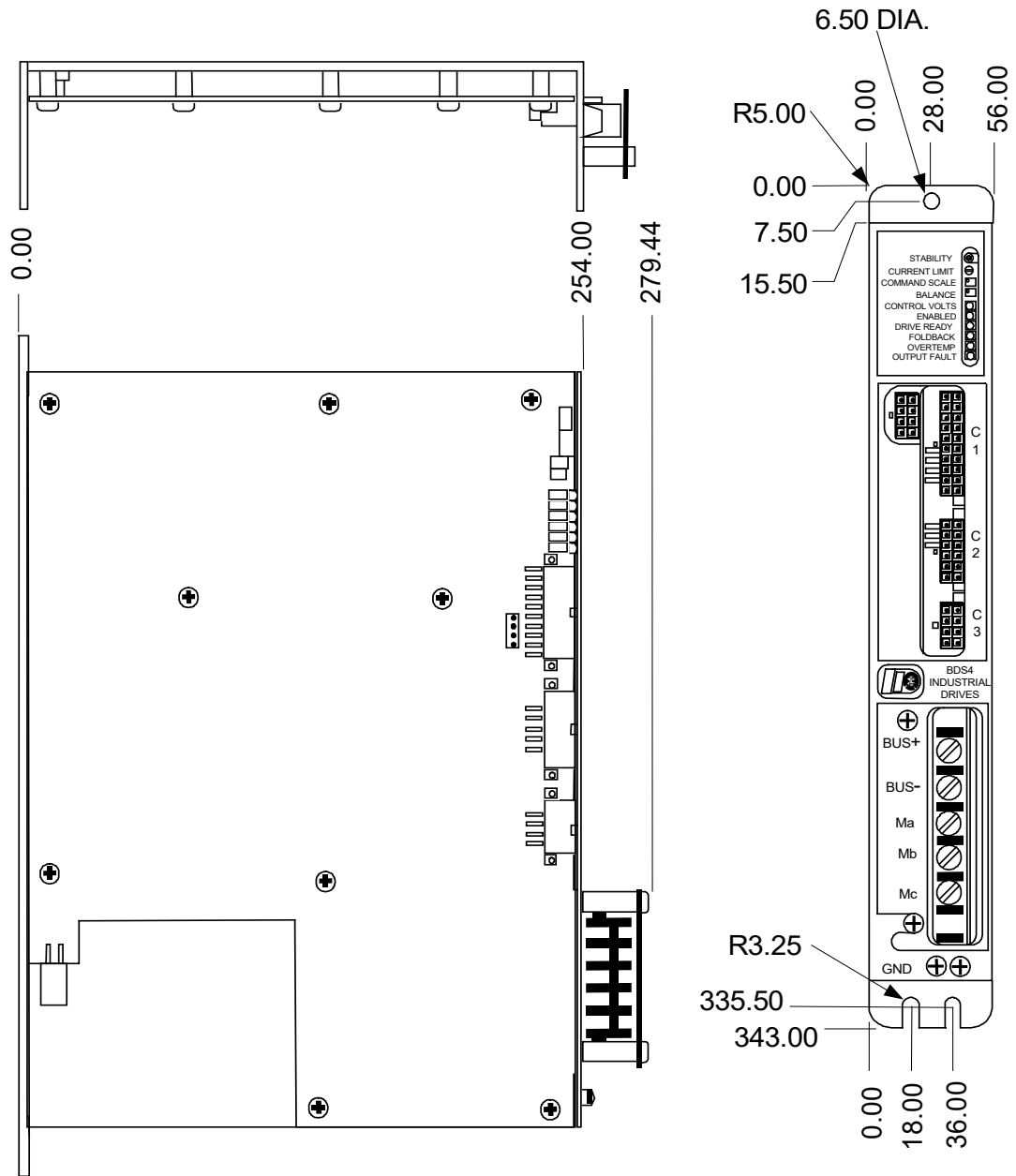
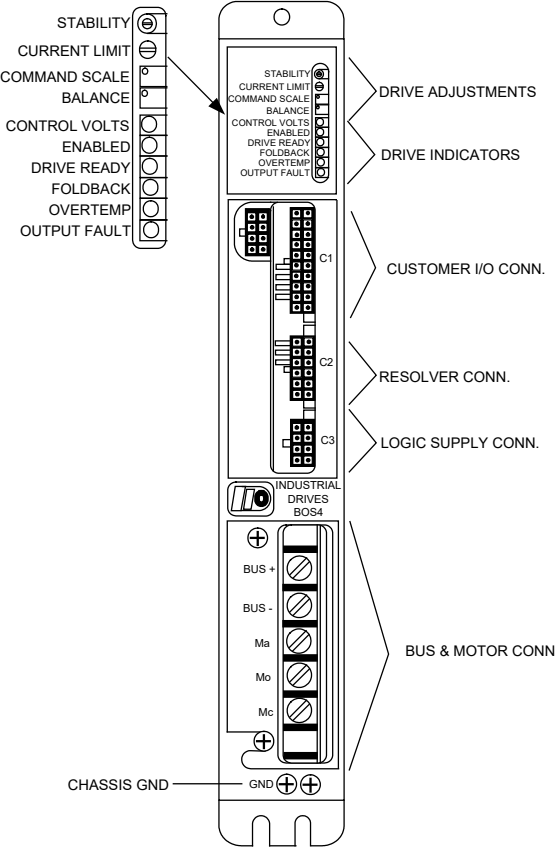
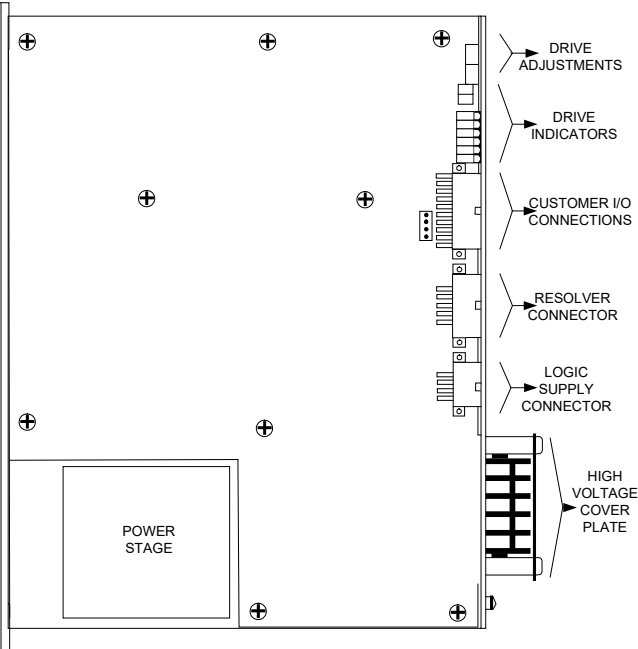

Figure A-84471

2.1.2 Front View



2.1.3 Side View



2.2 Typical Power Supply

2.2.1 Outline Dimensions

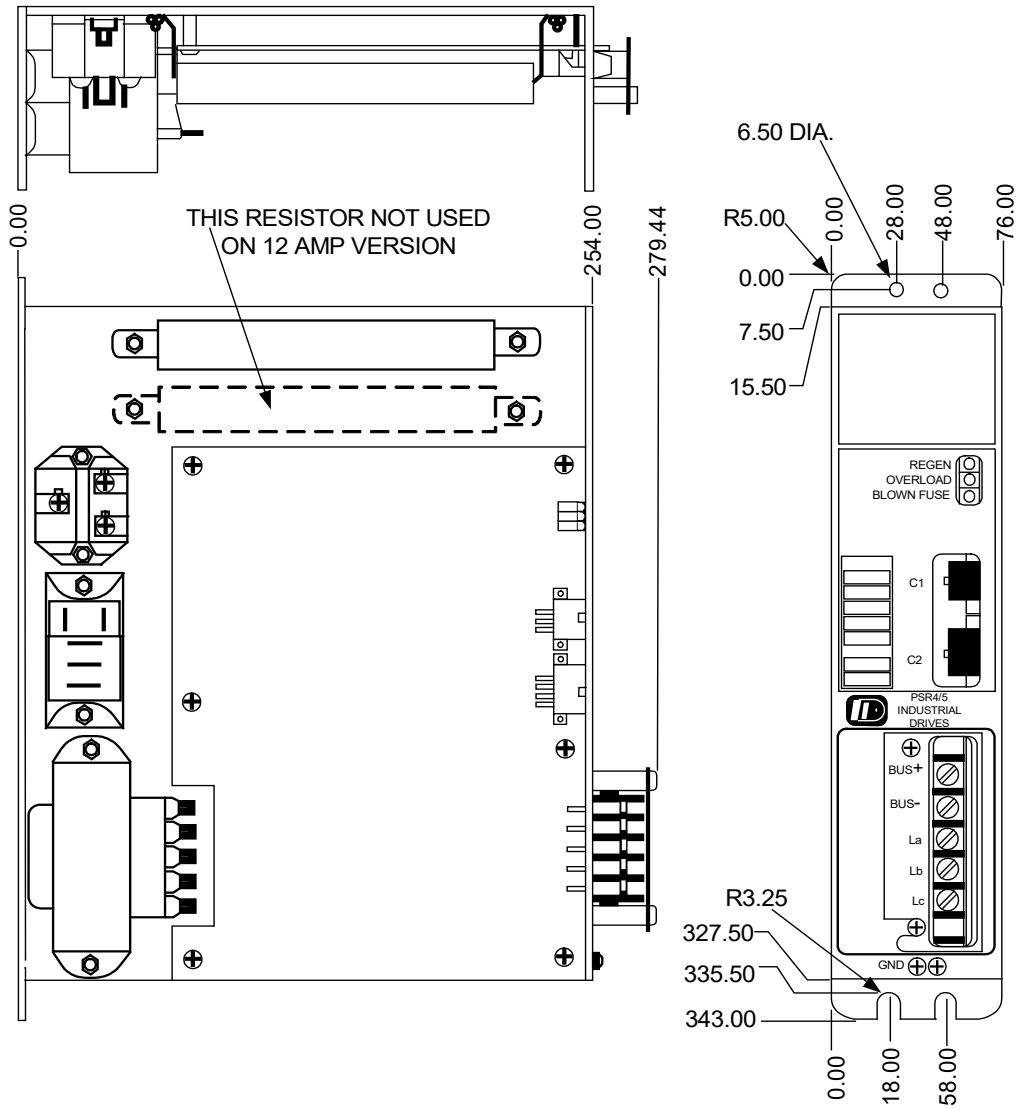

A-84468

2.2.2 Front View

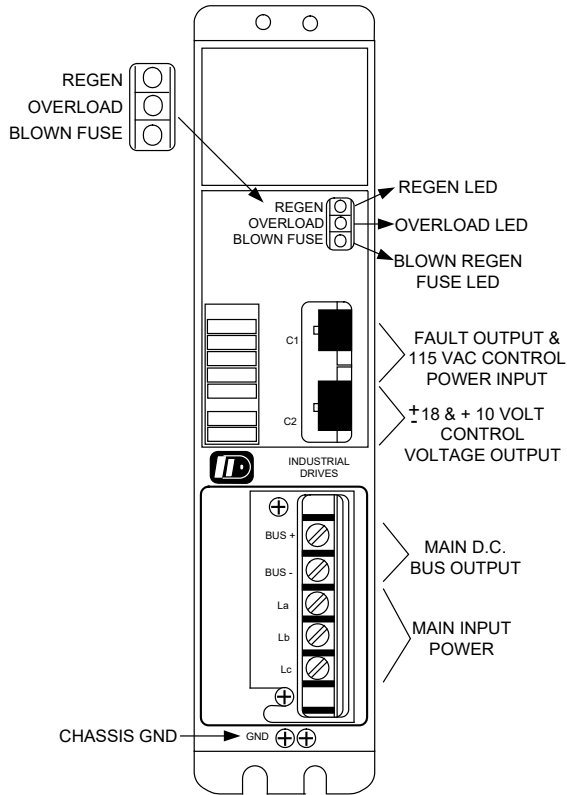

2.2.3 Side View

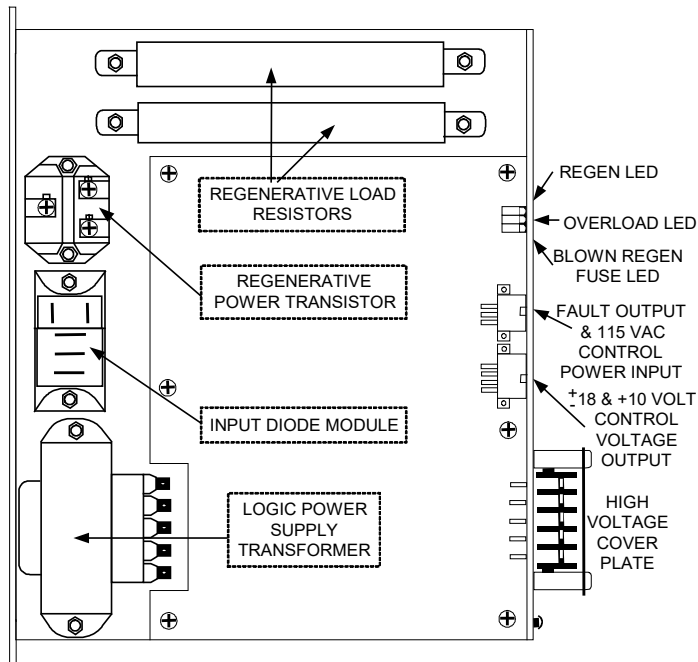

2.3 System Wiring

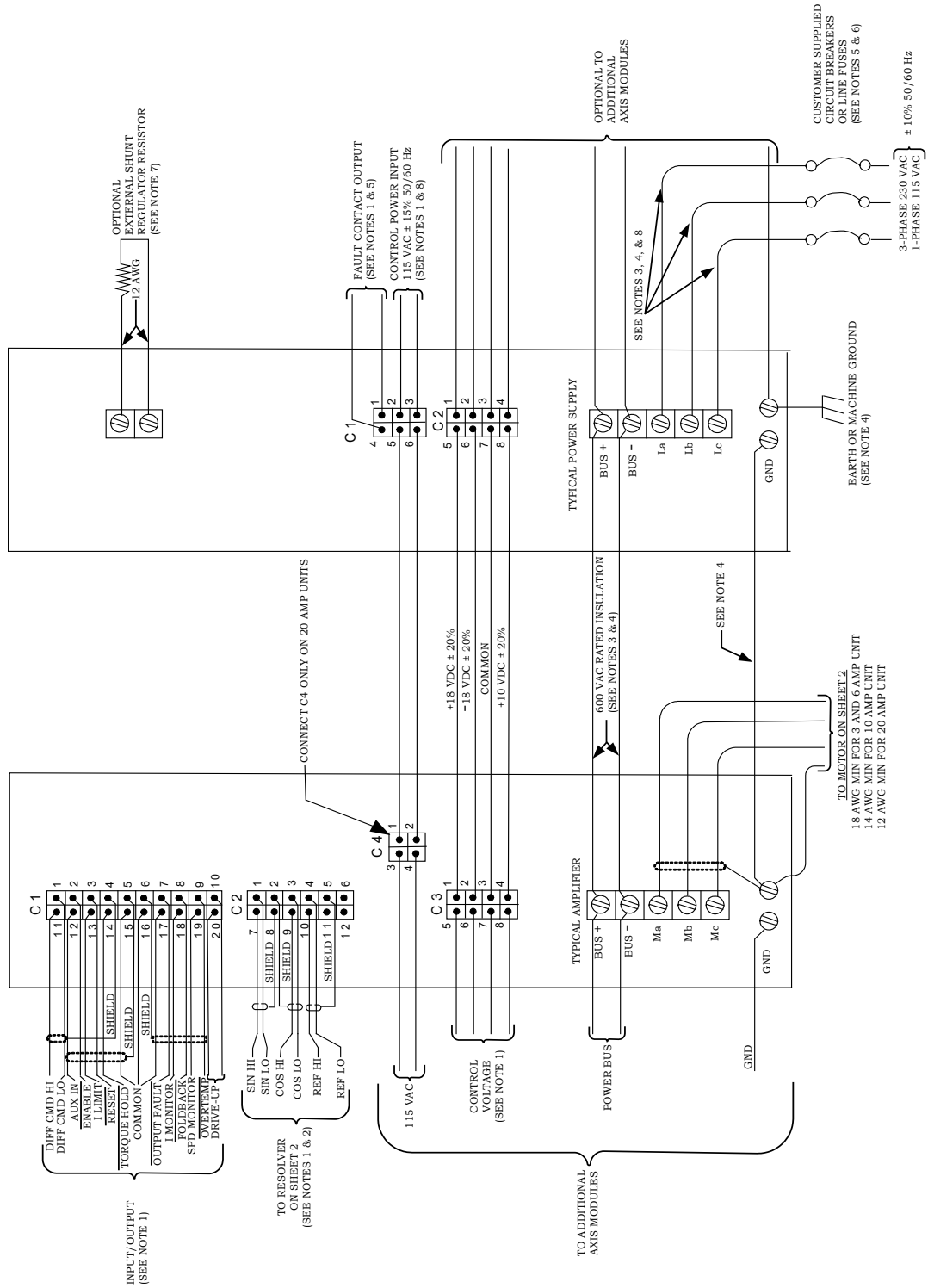

*Notes are shown on the next page

Notes for previous diagram:

1. All signal and control wire to be 22-18 AWG wire. If 16 AWG is desired, then use Molex #39-00-0078 crimp pins (not supplied) instead of the parts supplied.
2. Resolver must be wired with (3) sets of 2-conductor shielded pairs as shown. Thermostat wiring to be twisted pair.
3. The screws in the power terminal blocks are captive. Do not attempt to remove them got using ring terminals. Use locking type spring spade terminals such as Hollingsworth #XSS20954S or #SS20947SF for 16/14 AWG wire and #XSS20836 or #SS20832F for 12/10 AWG wire.
4. Wire gauge dependent on application: For total axis currents less than 9-amperes: 16 AWG may be used. For total axis currents greater than 20-amperes: 10 AWG must be used.
5. The power supply fault contact (rated 115 VAC 1 amp) should be wired to drop main 3-phase power (La, Lb, Lc) in fault conditions. (This contact is normally open, closed on power-up (approximately 0.250 ms) and opens in fault conditions.)
6. Fuse or circuit breaker sizing dependent on application.
 - PSR4 Recommended Fuse
 - 12 amp Buss #FAN-A-12 or equivalent
 - 20 amp Buss #FAN-A-20 or equivalent
7. Resistor must be mounted away from any flammable material. A 400 VDC potential is present (electrical isolation should be maintained for this voltage rating).
8. All AC lines should be twisted cables.

2.4 Typical Motor Connections

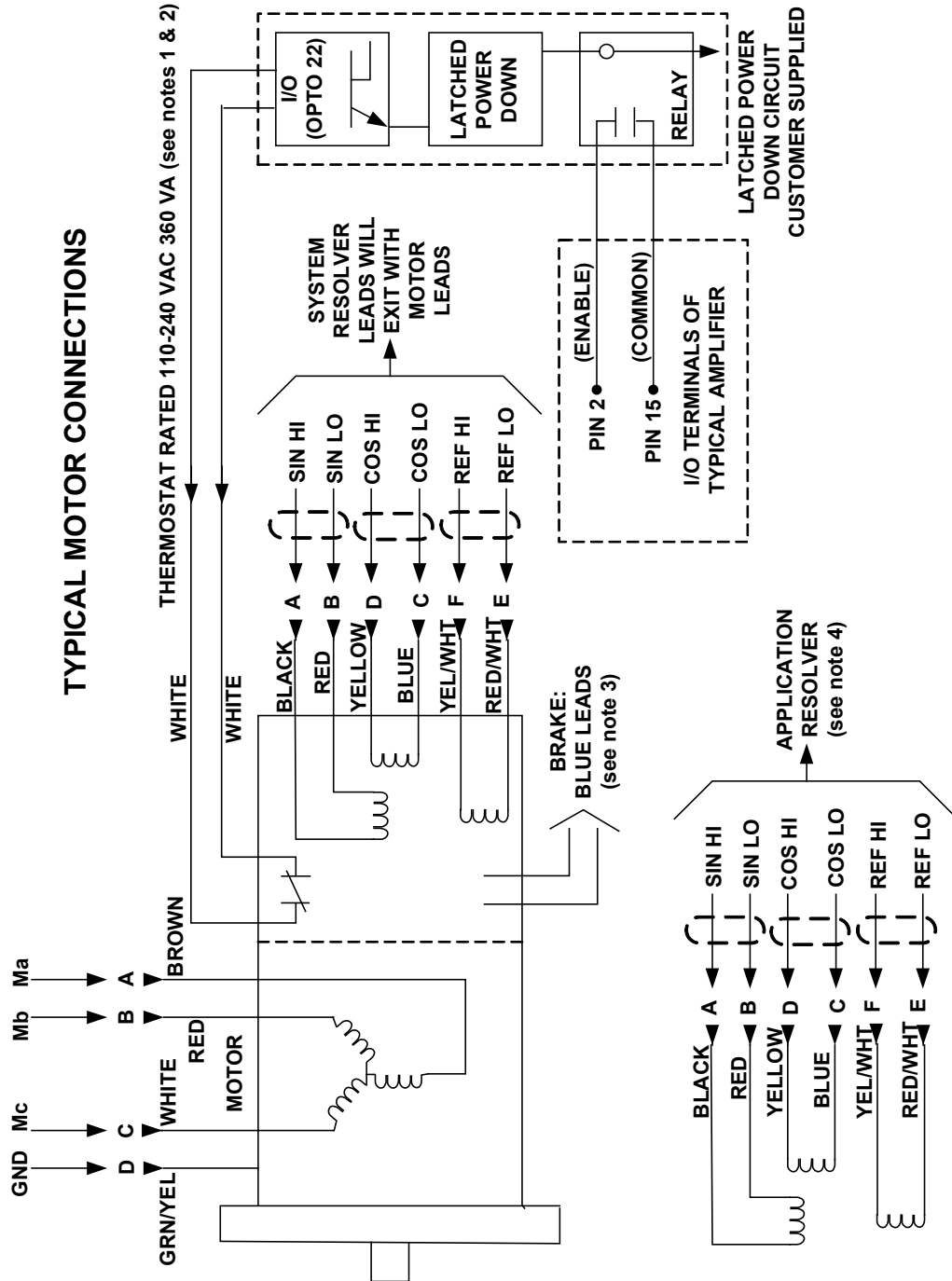

Notes are found on following page.

Notes for previous diagram:

1. The motor thermostat is an automatic resetting device and should be connected into a latched (lock-out) power down type circuit.
2. Thermostat to be wired with twisted pair.
3. The brake should be energized before switching the motor on and while it is in operation. For proper operation an electrical interlock circuit should be employed to ensure that the brake is not engaged while the motor is energized.

Model	Holding VDC	Holding ADC
EB-10X-X-XX-B2	90	0.18
EB-10X-X-XX-B3	24	0.60

4. Application resolver leads will exit at a different location than system resolver leads.

2.5 3-Phase Power Trans

DWG. # SH 1 OF 2
A-84469

ISSUE
1

DASH	X	A	B	C	D	E	F
001		8.5	12.5	6.5	7.0	4.88	
002							
003							
004		10.75	15.88	9.75	9.06	7.5	1.13
005							
006	9.50	12.0	15.25	8.5	13.5	7.25	5/8
007	13.5	14.0	20.75	8.16	13.0	7.31	3/4
008		12.0	16.0	8.5	15.5	6.87	.782
009							
010							
011		19.0	21.0	8.25	16.5	6.5	0.87
012							
013							
014							

EXAMPLE: IR3 - 230 / 7.5 - 16 - 00 ----- OPEN CONSTRUCTION

3 PHASE TRANSFORMER 240/480 VAC RMS PRIMARY

→ 240/480 PRIMARY (IRMS)

→ 230 VRMS SECONDARY

KOLLMORGEN Radford, Virginia

OUTLINE/CONNECTION 3

PHASE POWER TRANS.

SCALE DWG. # SH 1 OF 2 ISSUE
: **A-84469** 1

ISS	ECN NO.	DATE	APPD.	ISS	ECN NO.	DATE	APPD.

APPD. BY	DATE

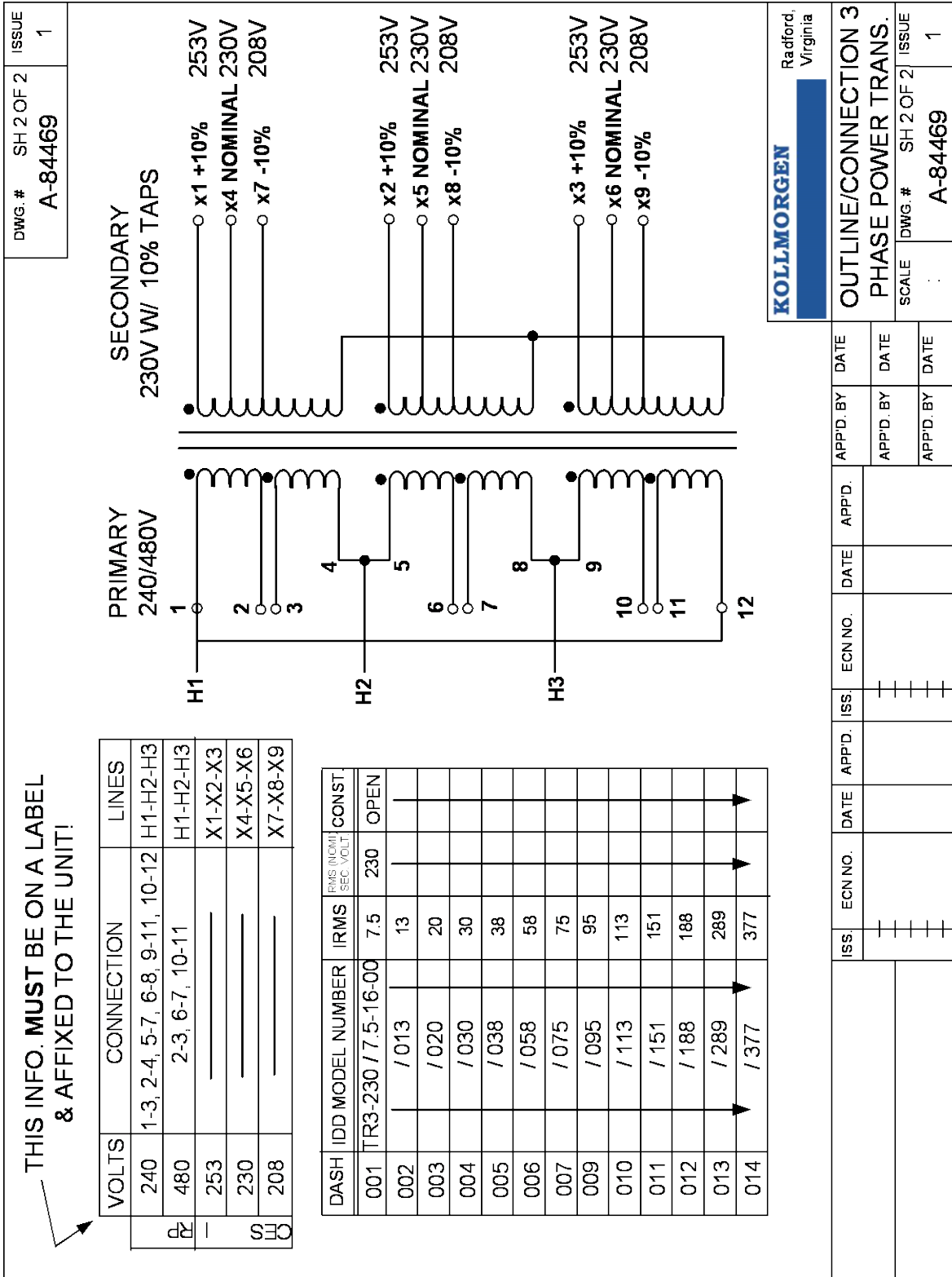

2.6 Grounding

Ground the motor at either the amplifier motor terminal block or at the main ground point. Connect shielded cables at one end only.

2.7 Inputs

The drive-up contact closure (internal) is provided at pins 10 and 20. When this internal contact is closed, it indicates to the outside world (software) that the typical amplifier is ready to operate. When open, it indicates it is in Inhibit mode. The contact is rated at 115 VAC at 2 amps.

⚠ CAUTION

The motor is provided with two normally closed thermostat reset devices connected in series. They are auto-resetting devices intended to shut the power down from the amplifier to limit the surface temperature of the motor to prevent ignition in hazardous atmospheres.

The remote Inhibit allows the amplifier to be disabled without removing the main power. When a contact is closed between pins 2 and 15 (D-common) the amplifier is placed in ready to operate mode. These pins (2 & 15) are connected through the latched power down circuit to the motor thermostat. The motor thermostat is an automatic resetting device used to shut the power down from the controller should an over-temperature condition occur in the motor windings. Connect the thermostat to a latched (locked-out) power down type circuit that requires manual reset. This prevents inadvertent restarting of the motor when it cools down below the thermostat's set value.

2.8 Preliminary Checks

Once the typical amplifier system has been installed and wired in, follow the steps below to ensure proper **operation before the main power is applied**.

2.8.1 Checking AC Input Voltage

Open the circuit breaker or remove the fuses in the secondary of the large 3-phase isolation transformer.

Apply power. With an AC voltmeter, check the 3-phase secondary line-to-line voltage. The voltage should be approximately $230 V_{RMS} \pm 10\%$.

Remove power. Close the circuit breaker or replace the fuses in the secondary of the large 3-phase isolation transformer.

2.8.2 Checking the Typical Power Supply DC Output Voltage

Do not apply the 115 VAC. Apply power to the large 3-phase transformer only. With a DC voltmeter, monitor the 325 VDC bus bars of the power supply and amplifier units. The voltage from the power supply should be approximately $\pm 325 VDC \pm 10\%$. Remove power.

2.8.3 Zero System Resolver

To Adjust the System Resolver to zero:

⚠ CAUTION Do not remove the cover while the motor is in a hazardous location.

1. Remove power.
2. Remove the motor end cover.
3. Loosen, but do not remove the resolver servo clamp screws.
4. Rotate the outer member of the resolver as needed for adjustment.
5. Replace and cover. All bolts must be tightened securely before applying power to the motor or resolver.

3. MOTOR DATA PACKAGE

This product's features and benefits are:

- UL-listed explosion-proof for Class I, Groups C & D hazardous locations
- Neodymium-Iron-Boron magnets
- Aluminum end bells
- Frameless, shaft-mounted resolver
- Rugged Construction

3.1 EB-10X

3.1.1 Model Number System

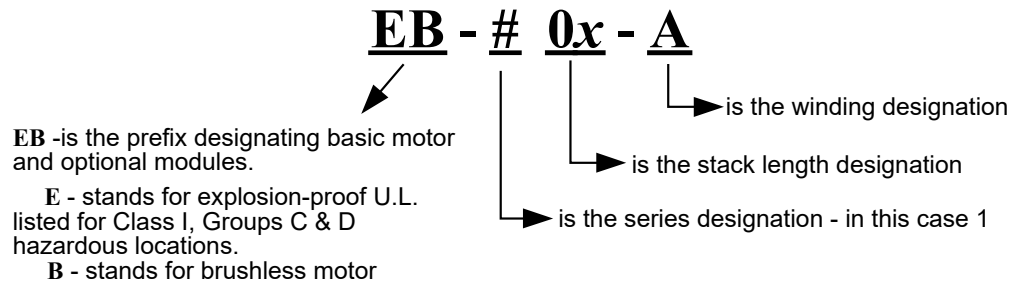

3.1.2 EB-10X-11-B2R102

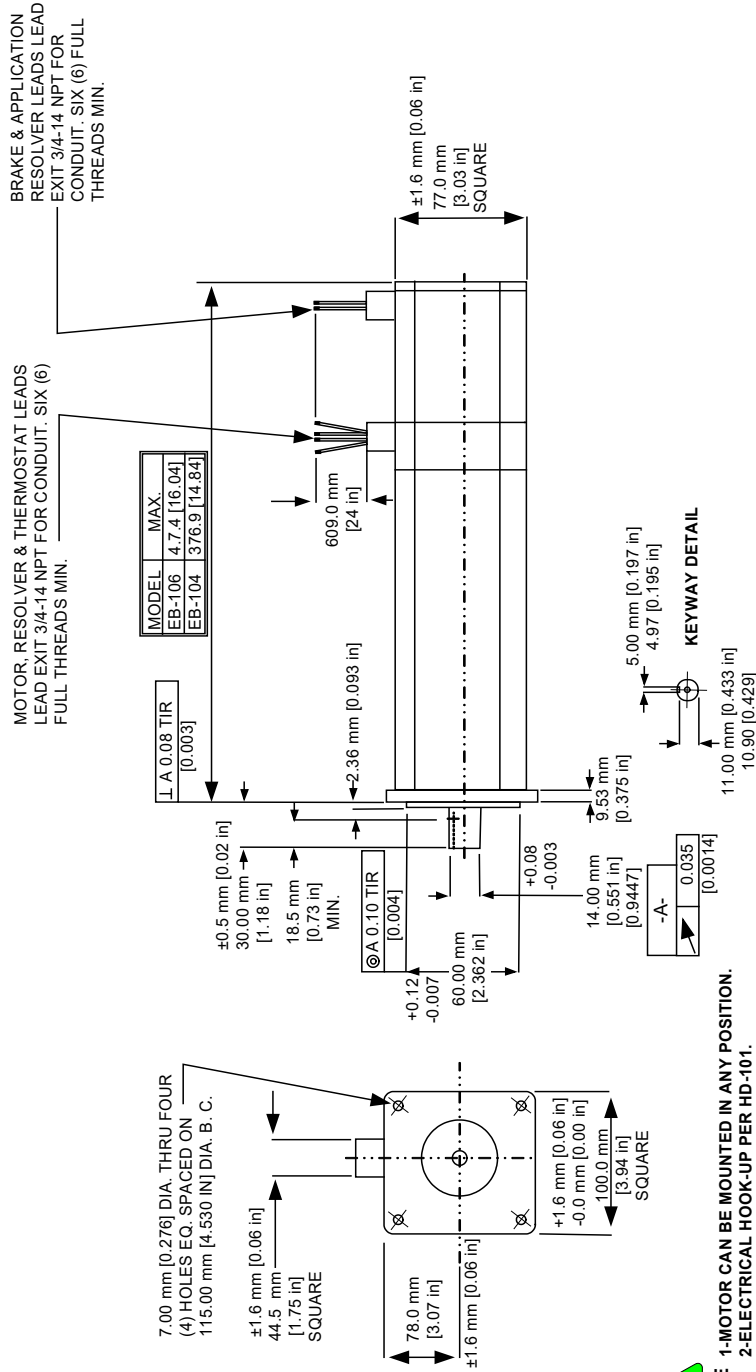

NOTE 1-MOTOR CAN BE MOUNTED IN ANY POSITION.
2-ELECTRICAL HOOK-UP PER HD-101.



A-62994

3.2 EB-102

3.2.1 Specifications CD-27131

Specification	Tol	Symbol	Units	A	
*Continuous Torque (stall) at 40° C Ambient	Nom.	T _C	lb-ft	0.62	
			N-m	0.84	
Cont. Line Current	Nom.	I _C	A _{RMS}	2.4	
†Max. Speed	Nom.	N max.	rpm	7500	
*Peak Torque	Nom.	T _P	lb-ft	1.78	
			N-m	2.41	
Peak Line Current	Nom.	I _P	A _{RMS}	7.2	
†Theoretical Acceleration	Nom.	α _m	rad/sec ²	78070	
†Horsepower	Rated	H _P rtd	HP	0.73	
†Speed	Rated	N rtd	rpm	7500	
†Torque	Rated	T rtd	lb-ft	0.51	
			N-m	0.69	
Volts (line to line)	Rated	V rtd	V _{RMS}	230	
*Torque Sensitivity	± 10%	K _T	lb-ft / A _{RMS}	0.260	
			N-m / A _{RMS}	0.353	
Back EMF (line-to-line)	± 10%	K _B	V/krpm	21.32	
Max. line-to-line volts	Max.	V max	V _{RMS}	250	
DC Res at 25° C (line-to-line)	± 10%	R _M	ohms	6.8	
Inductance (line-to-line)	± 30%	L _M	mH	30	
Time Constant at 25° C	Mech.	Nom.	T _M	ms	2.54
	Elec.	Nom.	T _E	ms	4.4
System Performance Curve				26853	

*At ultimate winding temperature for ambient data multiply by 1.06

†	Symbol	Units	Value
Rotor Inertia	J_M	lb ft sec ²	0.0000228
		kg m ²	0.0000309
Weight	Wt	lb	5.5
		kg (f)	2.5
Static Friction	T_F	lb-ft	0.03
		N-m	0.04
Thermal Time Constant Peak	TCTP	Minutes	2
Viscous Damping ∞Z Source	F_1	lb-ft/krpm	0.0015
		N-m/krpm	0.0020

† If brush type tach is used, these parameters may be affected. Consult the factory.

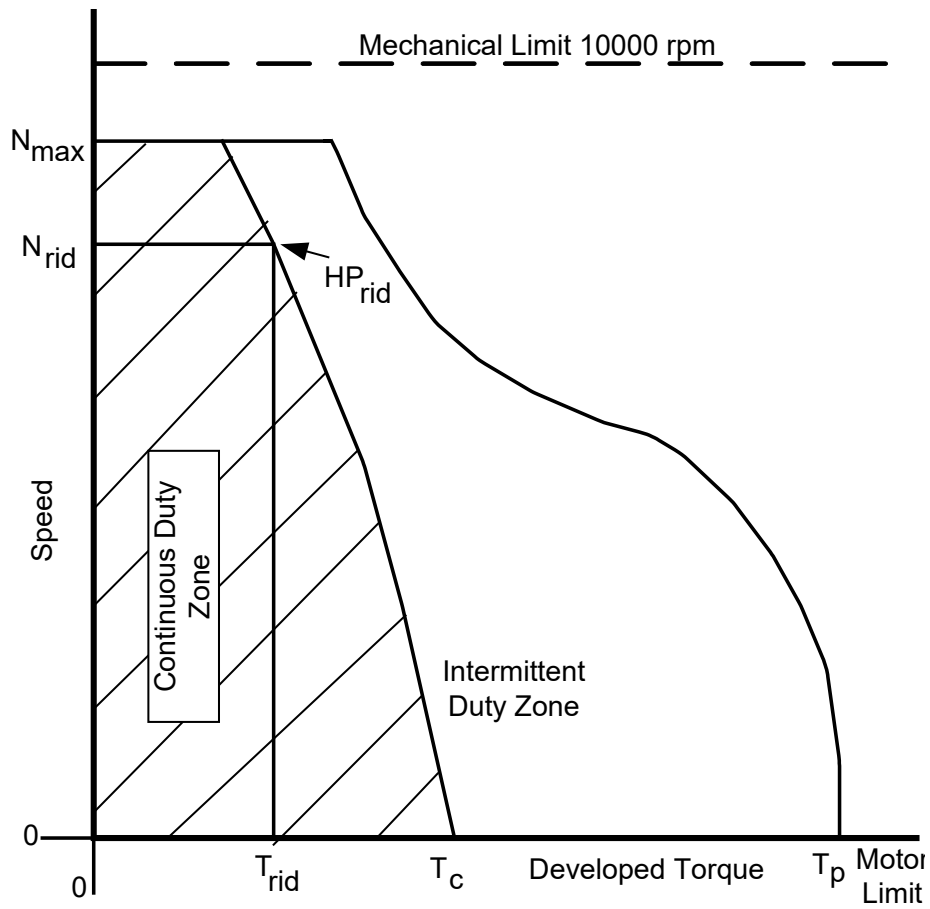

3.2.2 Performance Curves

3.2.2.1 EB-102-A PC-26853

NOTE

Do not operate this motor outside the parameters shown on this performance curve.

Motor B-102-A
 Drive BDS4-203
 Test T3-1667

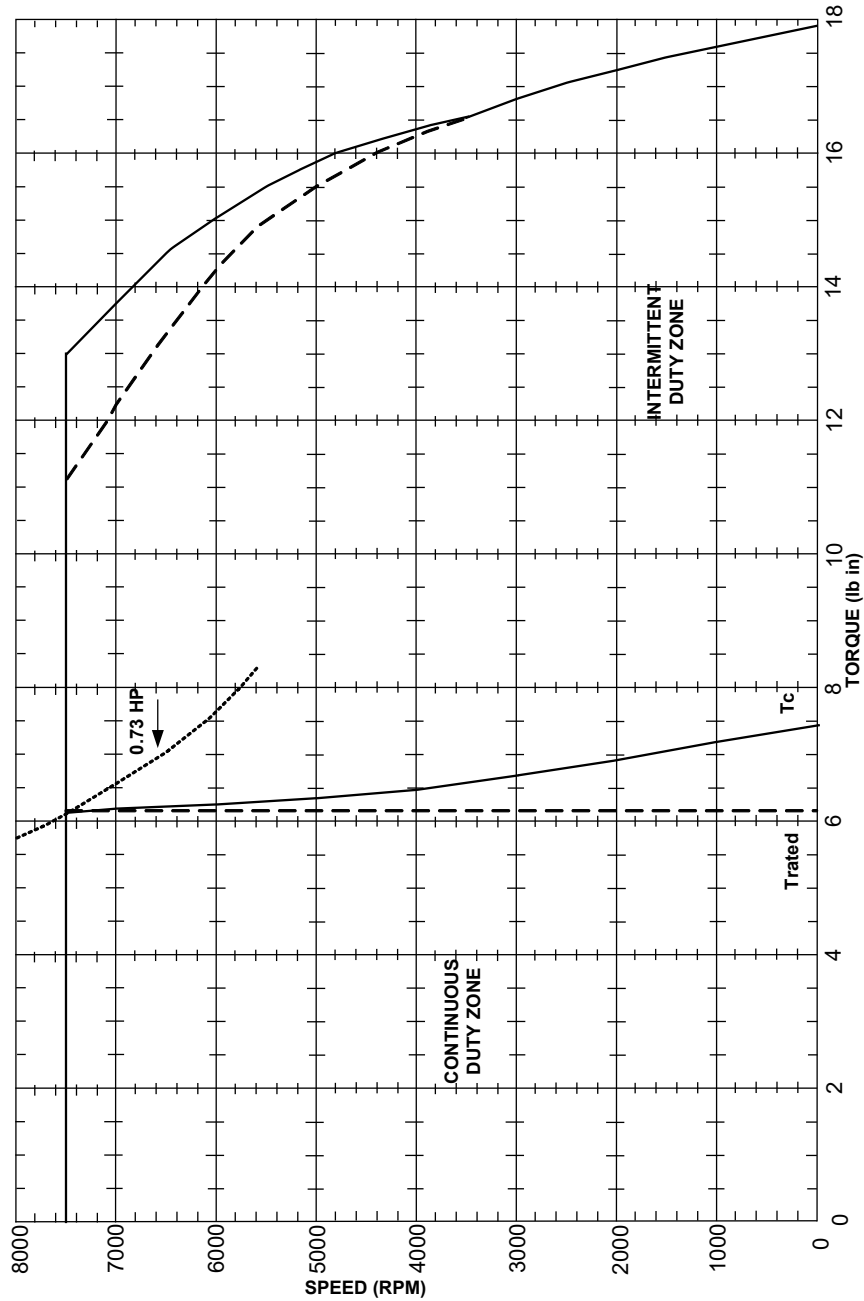

3.3 EB-104

3.3.1 Specifications CD-27132

Specification	Tol	Symbol	Units	A	B	
*Continuous Torque (stall) at 40° C Ambient	Nom.	T _C	lb-ft	1.14	1.16	
			N-m	1.55	1.57	
Cont. Line Current	Nom.	I _C	A _{RMS}	3.00	4.20	
†Max. Speed	Nom.	N max.	rpm	5600	7500	
*Peak Torque	Nom.	T _P	lb-ft	3.23	3.28	
			N-m	4.38	4.45	
Peak Line Current	Nom.	I _P	A _{RMS}	9.0	12.6	
†Theoretical Acceleration	Nom.	α _m	rad/sec ²	9500	96500	
†Horsepower	Rated	H _P rtd	Hp	1.2	1.5	
†Speed	Rated	N rtd	rpm	5600	7500	
†Torque	Rated	T rtd	lb-ft	1.14	1.06	
			N-m	1.55	1.44	
Volts (line to line)	Rated	V rtd	V _{RMS}	230	230	
*Torque Sensitivity	± 10%	K _T	lb-ft / A _{RMS}	0.378	0.274	
			N-m / A _{RMS}	0.512	0.370	
Back EMF (line-to-line)	± 10%	K _B	V/krpm	31.0	22.5	
Max. line-to-line volts	Max.	V max	V _{RMS}	250	230	
DC Res at 25° C (line-to-line)	± 10%	R _M	ohms	5.30	2.72	
Inductance (line-to-line)	± 30%	L _M	mH	28.1	14.4	
Time Constant at 25° C	Mech.	Nom.	T _M	ms	1.4	1.4
	Elec.	Nom.	T _E	ms	5.3	5.3
System Performance Curve				26922	26923	

*At ultimate winding temperature for ambient data multiply by 1.06

†	Symbol	Units	Value
Rotor Inertia	J_M	lb ft sec ²	0.0000340
		kg m ²	0.0000461
Weight	Wt	lb	7.0
		kg (f)	3.2
Static Friction	T_F	lb-ft	0.04
		N-m	0.05
Thermal Time Constant Peak	TCTP	Minutes	3
Viscous Damping $\propto Z$ Source	F_1	lb-ft/krpm	0.0020
		N-m/krpm	0.0027

† If brush type tach is used, these parameters may be affected. Consult the factory.

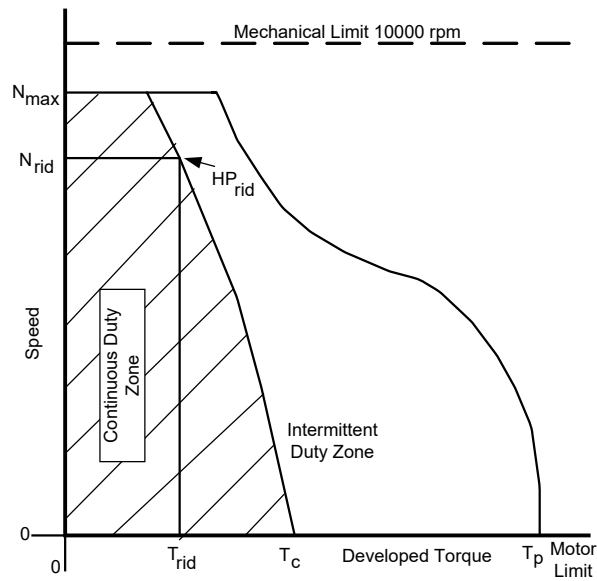

3.3.2 Performance Curves

3.3.2.1 EB-104-A PC-26922

NOTE

Do not operate this motor outside the parameters shown on this performance curve.

Motor EB-104-A
 Drive BDS4-203
 Test T3-1628

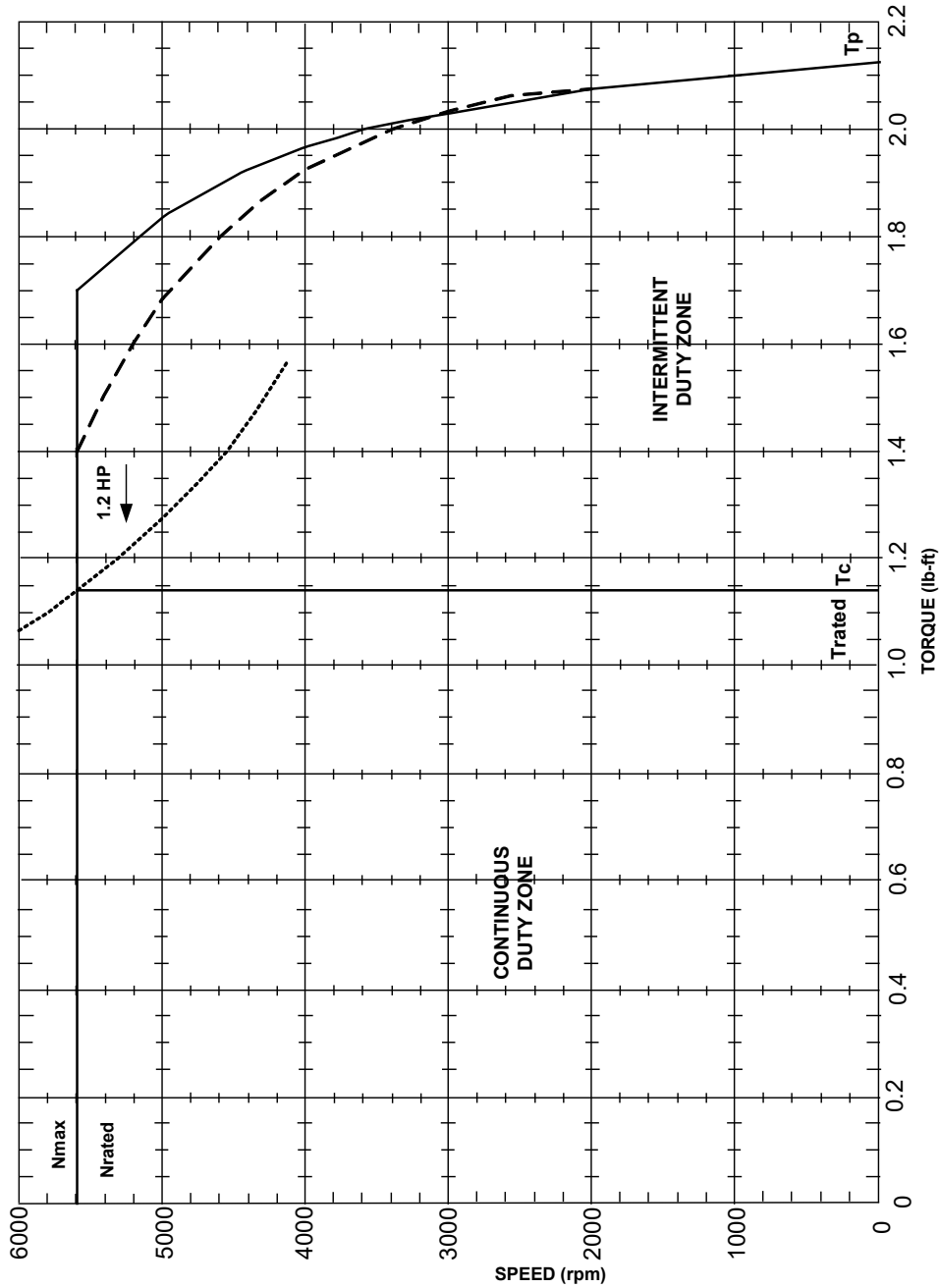

3.3.2.2 EB-104-B PC-26923

NOTE

Do not operate this motor outside the parameters shown on this performance curve.

Motor B-104-B
 Drive BDS4-206
 Test T3-1629

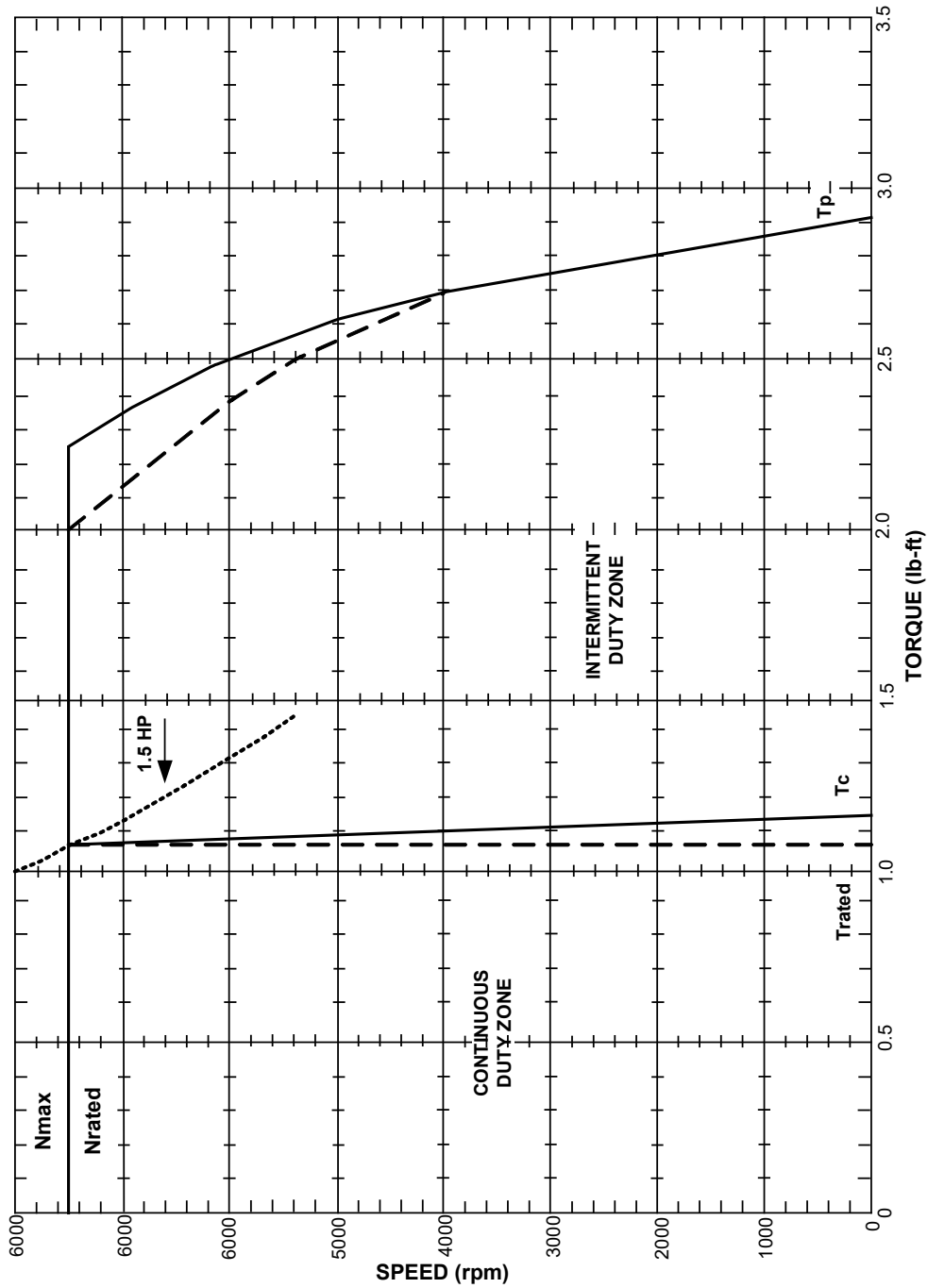

3.4 EB-106

3.4.1 Specifications CD-27133

Specification	Tol	Symbol	Units	A	B	
*Continuous Torque (stall) at 40° C Ambient	Nom.	T _C	lb-ft	1.62	1.64	
			N-m	2.20	2.22	
Cont. Line Current	Nom.	I _C	A _{RMS}	3.00	6.0	
†Max. Speed	Nom.	N max.	rpm	4200	7500	
*Peak Torque	Nom.	T _P	lb-ft	4.56	4.68	
			N-m	6.18	6.35	
Peak Line Current	Nom.	I _P	A _{RMS}	9.0	18.0	
129.2†Theoretical Acceleration	Nom.	∞m	rad/sec ²	80850	82980	
†Horsepower	Rated	H _P rtd	H _P	1.2	2.0	
†Speed	Rated	N rtd	rpm	4200	7500	
†Torque	Rated	T rtd	lb-ft	1.5	1.38	
			N-m	2.0	1.87	
Volts (line to line)	Rated	V rtd	V _{RMS}	230	230	
*Torque Sensitivity	± 10%	K _T	lb-ft / A _{RMS}	0.533	0.274	
			N-m / A _{RMS}	0.723	0.370	
Back EMF (line-to-line)	± 10%	K _B	V/krpm	43.7	22.5	
Max. line-to-line volts	Max.	V max	V _{RMS}	250	250	
DC Res at 25° C (line-to-line)	± 10%	R _M	ohms	6.50	1.60	
Inductance (line-to-line)	± 30%	L _M	mH	37.5	9.4	
Time Constant at 25° C	Mech.	Nom.	T _M	ms	1.4	1.3
	Elec.	Nom.	T _E	ms	5.8	5.9
System Performance Curve				26927	26928	

*At ultimate winding temperature for ambient data multiply by 1.06

†	Symbol	Units	Value
Rotor Inertia	J_M	lb ft sec ²	0.0000564
		kg m ²	0.0000765
Weight	Wt	lb	8.5
		kg (f)	3.9
Static Friction	T_F	lb-ft	0.05
		N-m	0.07
Thermal Time Constant Peak	TCTP	Minutes	4
Viscous Damping ∞Z Source	F_1	lb-ft/krpm	0.003
		N-m/krpm	0.004

† If brush type tach is used, these parameters may be affected. Consult the factory.

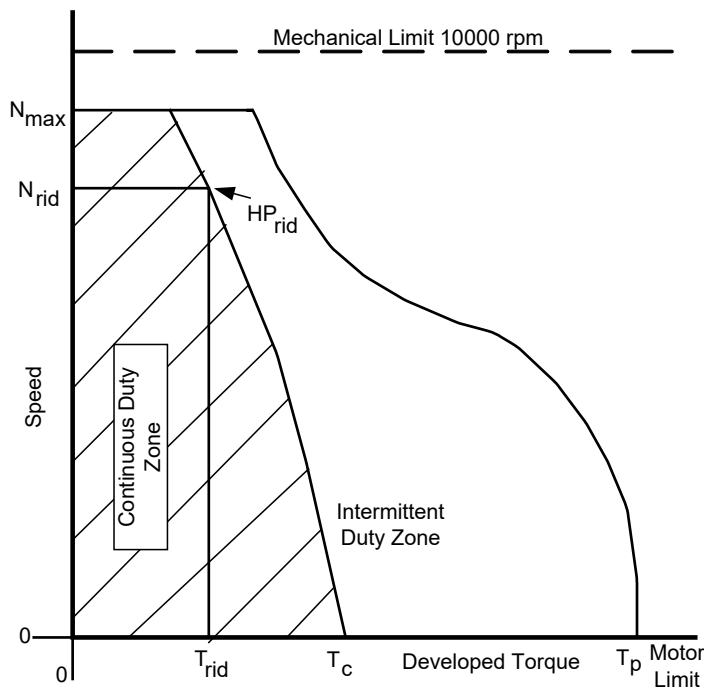

3.4.2 Performance Curves

3.4.2.1 EB-106-A PC-26927

NOTE

Do not operate this motor outside the parameters shown on this performance curve.

Motor B-106-A
 Drive BDS4-203
 Test T3-1630

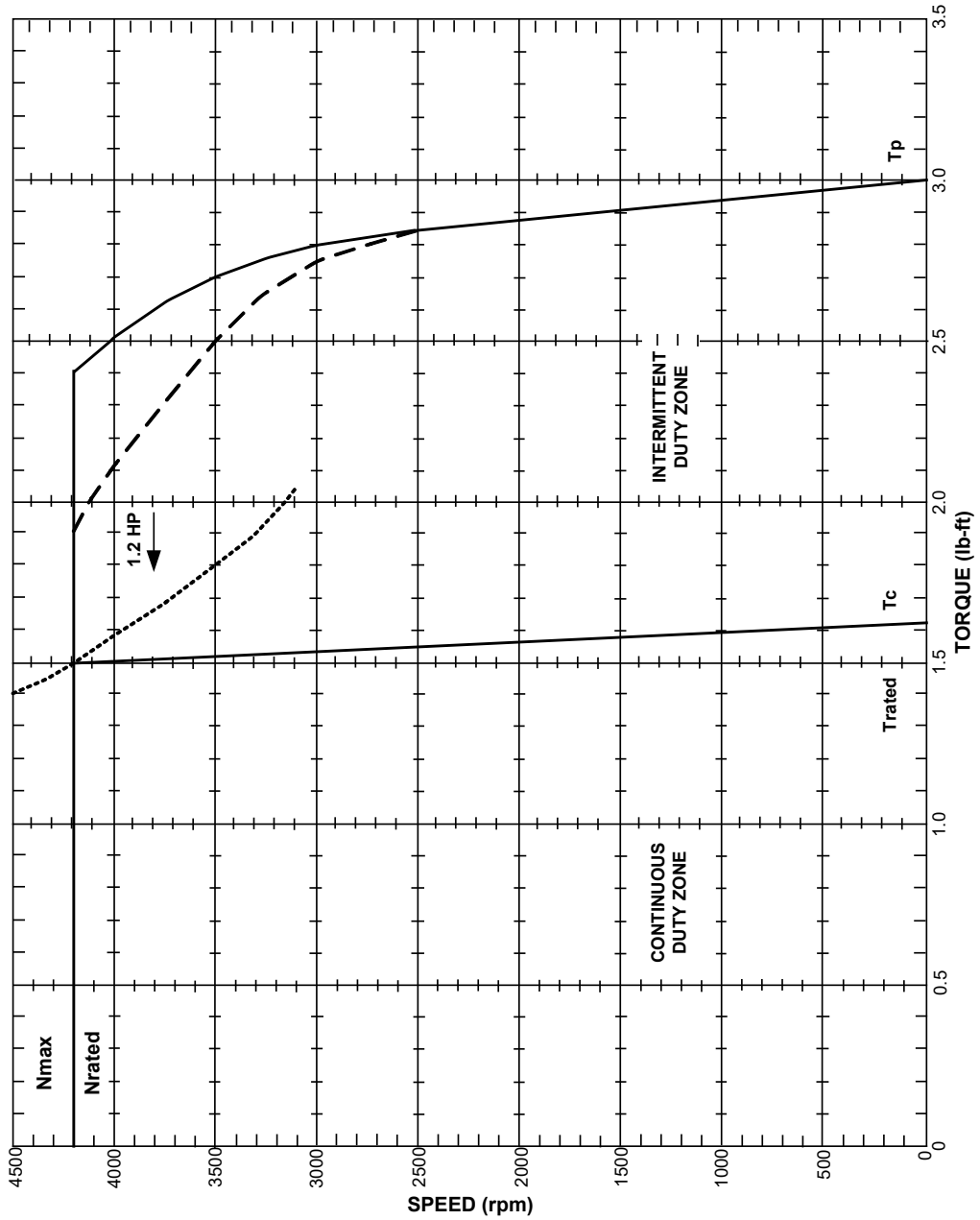

3.4.2.2 EB-106-B PC-26928

NOTE

Do not operate this motor outside the parameters shown on this performance curve.

Motor EB-106-B
 Drive BDS4-206
 Test T3-1631

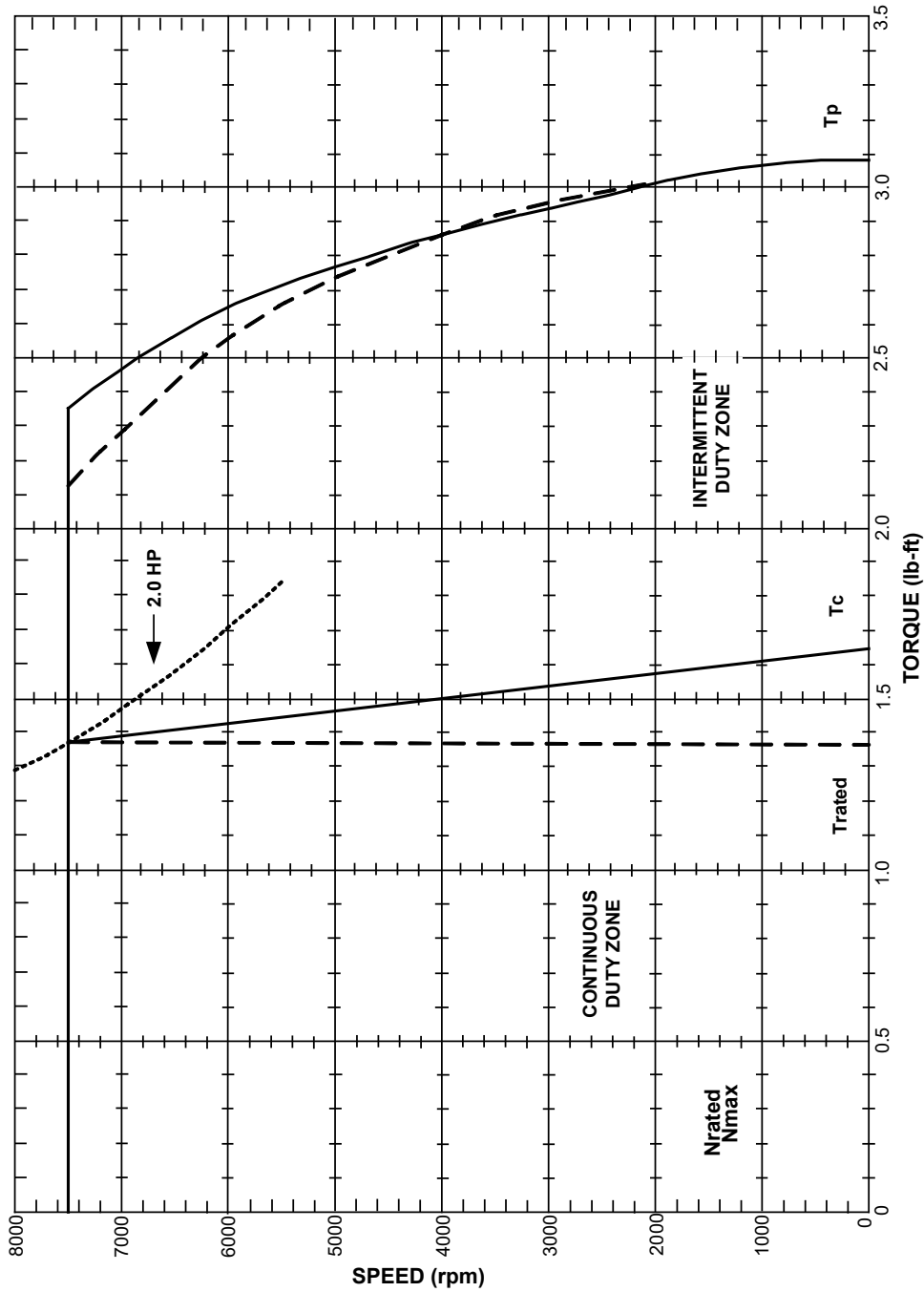

3.5 EB-60x Typical Current and Voltage (Wave forms at Motor)

3.5.1 Current Phase C

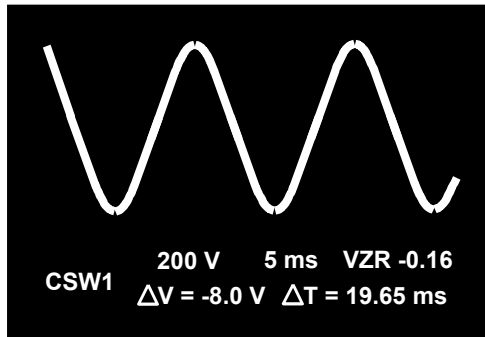

3.5.2 Voltage line A-C

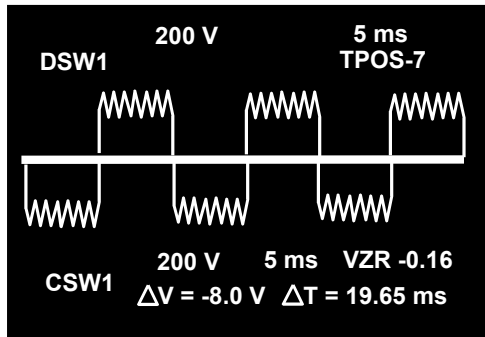

The EB-106-B is illustrated at 600 rpm, 19.5 in-lb.

3.6 Intermittent Duty Operation

If a motor operates intermittently, it is not necessary that the peak load torque fall within the motor's continuous torque capabilities. However, it is important that the RMS (root mean square) load torque be inside the continuous duty zone. Note that a sufficient OFF time follows each On time of the motor.

Equation 1 (EQ-1) gives the RMS torque:

$$(EQ-1) \quad T_{RMS} = \sqrt{\frac{T_1^2 t_1 + T_2^2 t_2 + \dots + T_i^2 t_i}{t_1 + t_2 + \dots + t_i}}$$

T_i = Torque at Time i
 t_i = Duration of time i

This equation assumes t_i is small compared to the thermal time constant for peak power of motor (TCTP) for torque values significantly larger than the continuous torque (T_c). This is not always a good assumption. For cases where torque values significantly exceed T_c , the following equation is used:

$$\frac{T_{OUT}}{T_c} = \sqrt{\frac{1 - e^{-t_{ON}/\text{Duty Cycle} * TCTP}}{1 - e^{-t_{ON}/TCTP}}}$$

where, duty cycle = $t_{ON}/(t_{ON} + t_{OFF})$
 T_{OUT} = output torque
 T_c = continuous torque at operating speed
 t_{ON} = time on
 TCTP = thermal time constant for peak power of motor

This equation expresses operating torque as a function of ON time. It also breaks the operating cycle down into individual periods of ON time and OFF time. Substituting for duty cycle and solving for t_{OFF} , the above equation yields Equation 2 (EQ-2):

$$(EQ-2) \quad T_{OFF} = -TCTP \ln \left[1 - \frac{(1 - e^{-t_{ON}/TCTP}) T_{OUT}^2}{T_c^2} \right]^{-t_{ON}}$$

For a specific output torque and a given ON time, the required OFF time is known. This OFF time is required so the motor cools sufficiently and does not exceed its thermal limits. The calculated OFF time should proceed the initial ON time to ensure that the ultimate temperature is not surpassed on the first cycle.

It may also be useful to calculate a time to ultimate experience temperature based on a one-time excursion from ambient temperature. Consider the following pair of equations:

$$(EQ-3) \quad T_R \text{ Actual Above Ambient} = T_R \text{ Rated Above Ambient} \left[\frac{T_{OUT}}{T_c} \right]^2$$

$$(EQ-4) \quad T_R \text{ Rated} = T_R \text{ Ultimate} (1 - e^{-t})$$

where T_R Rated = time/TCTP
 Substitute 3) into 4) and obtain:

$$T_R \text{ Actual} \left(\frac{T_C}{T_{OUT}} \right)^2 = T_R \text{ Ultimate} (1 - e^{-t/TCTP})$$

To find the time to ultimate temperature, set T_R actual = T_R ultimate and solve for t. This yields the following equation:

$$(EQ-5) \quad T_{MAX} = -TCTP \ln \left[1 - \left(\frac{T_{OUT}}{T_C} \right)^2 \right]$$

where: t = max on time
 TCTP = thermal time constant of motor
 T_C = continuous torque of the motor at the particular operating speed
 T_{OUT} = operating torque

This gives the maximum ON time for a given operating torque beginning at ambient temperature. Examination of this equation reveals that as T_{OUT} approaches T_C , t approaches infinity. This is expected since we can theoretically operate the motor indefinitely at continuous torque without exceeding its thermal limits. EQ-5, with EQ-2, define the motor's operating time limits.

Example #1

An EB-106-B has the torque vs. speed performance characteristics described in the performance curve labeled EB-106-A PC-26927. The motor is operating intermittently at 4000 rpm with a torque of 2.9 lb-ft.

FIND:

- a) maximum ON time without exceeding ultimate temperature
- b) the required OFF time for an ON time of 4 seconds

GIVEN: $T_{OUT} = 2.9$ lb-ft

From performance curve (EB-106-A PC-26927), the continuous torque at 4000 rpm is obtained.

$$T_C = 1.5 \text{ lb. ft.}$$

From Specifications CD-27133 for the EB-106-B motor:

$$TCTP = 4 \text{ min.}$$

(a) The maximum ON time is found from (EQ-5):

$$T_{MAX} = -TCTP \ln \left[1 - \left(\frac{T_{OUT}}{T_C} \right)^2 \right]$$

TCTP = 4 minutes
 $T_C = 1.5$ lb-ft
 $T_{OUT} = 2.9$ lb-ft

$$T_{MAX} = -4 \text{ min } 1n \left[1 - \left(\frac{1.5}{2.9} \right)^2 \right]$$

$$t_{MAX} = -4 \text{ min. } 1n [0.7325]$$

$$t_{MAX} = -4 \text{ min. } (0.3113)$$

$$t_{MAX} = 1.25 \text{ minutes}$$

If the motor has an ON time greater than 1.25 minutes, it exceeds its thermal limits.

(b) The required OFF time for a given ON time is found from (EQ-2).

$$T_{OFF} = -TCTP \ 1n \left[1 - \frac{(1 - e^{-t_{ON}/TCTP}) T_{OUT}^2}{T_C^2} \right] - t_{ON}$$

$$t_{ON} = 4 \text{ seconds}$$

$$TCTP = 4 \text{ min } 60 \text{ sec/min} = 240 \text{ sec.}$$

$$t_{OUT} = 2.9 \text{ lb-ft}$$

$$T_C = 1.5 \text{ lb-ft}$$

$$T_{OFF} = -240 \text{ sec } 1n \left[1 - \frac{(1 - e^{-4/240}) 2.9^2}{(1.5)^2} \right] - 4 \text{ sec}$$

$$t_{OFF} = -240 \text{ sec } 1n 0.9383 - 4 \text{ sec}$$

$$t_{OFF} = 11.3 \text{ sec}$$

For the EB-106-B motor operating at the load point in this example, an ON time of 4 seconds must be followed by an OFF time of 11.3 seconds to not exceed its thermal limits.

Example #2

The motor of Example #1 is running at 600 rpm with an intermittent operating torque of 3.07 lb-ft.

FIND:

- a) maximum ON time.
- b) required OFF time for an ON time of 4 seconds.

GIVEN: $T_{OUT} = 3.07 \text{ lb-ft.}$

From performance curve (EB-106-A PC-26927):
 T_C at 600 rpm = 1.63 lb-ft.

From Specifications CD-27133:
 $TCTP = 4 \text{ min.}$

Using (EQ-5) and above values:

$$t_{MAX} = 1.31 \text{ min.}$$

Using (EQ-2) and an ON time of 4 seconds, an OFF time is:

$$t_{OFF} = 10.4 \text{ sec.}$$

Example #3

The motor of Example 1 is running at 7500 rpm with an intermittent operating torque of 2.35 lb-ft.

FIND:

- (a) maximum ON time.
- (b) required OFF time for an ON time of 4 seconds.

GIVEN: $t_{OUT} = 2.35$ lb-ft.

From performance curve (EB-106-A PC-26927):

$T_C = 1.30$ lb-ft. at 7500 rpm

From Specifications CD-27133:

TCTP = 4 min.

Using (EQ-5) and above values:

$t_{MAX} = 1.7$ minutes

$t_{ON} = 4$ seconds

Using (EQ-2) and known values:

$t_{OFF} = 7.8$ sec

NOTE

The applications engineers at Kollmorgen can assist in the proper sizing of the motor and amplifier based on the applications' duty cycle. Contact them if any questions arise in the derivation of t_{MAX} or t_{OFF} with a specific duty cycle

4 TYPICAL AMPLIFIER DATA PACKAGE

The product features are:

- 30 microprocessor synthesized sine-wave control
- Three AC current loops – fully integrating velocity loop
- OK to Enable or Drive-Up relay
- Inhibit function
- Current monitor

4.1 Typical Amplifier Specifications

Amplifier Specifications		
Input Power to Amplifier	230 VRMS L-L 30 (±15%)	
	Isolation Transformer Not Required	
	115 VAC 10 Control Power (+10%, -15%)	
Output Power to Motor	Power Supply DC Bus	325 VDC nominal, no load
	Output at rated load%	230 VRMS L-L, Nominal ±15% Pulse Width Modulated
	Cont. Current (ARMS/Phase)	Intermittent Current (5 sec. max., 25% duty cycle)
	As required to produce motors rated current	200% of continuous
Ambient Operating Temperature	0-55° C	
Switching Frequency	10 kHz	
Cooling	Fan, Convection (cold plate)	

Save these instructions for future reference.

5 INDEX

3 Phase Power Trans.....	15, 16	EB 106 Specifications	29
Amplifier		EB 106-A	
ambient temperature	38	Performance Curve	31
continuous current.....	38	EB 106-B	
cooling	38	Performance Curve	32
input power to amplifier	38	EB 10X.....	19
isolation transformer	38	EB 602-A	
output at rated load.....	38	performance curve	24
power supply DC bus	38	EB-102	20
power supply settings	5	EB-10x	4
Preliminary Checks.....	17	EB-602-A	24
Ratings	5	performance curve	24
specifications	38	Equation 1.....	34
switching frequency	38	Equation 2.....	34
typical.....	4	Equation 3.....	34
Amplifier Data Package.....	38	Equation 4.....	34
Axis		Equation 5.....	35
currents.....	12	Example 1	35
Brake	14	Fuse sizing.....	12
electrical interlock circuit.....	14	Grounding	17
Breaker		Inhibit	
sizing.....	12	remote	17
Cables		Input Power.....	5
AC lines	12	Inputs	
Cooling	5	signal	17
DC Bus	4	Intermittent Duty Operation.....	34
EB 102 Specifications	21	Introduction	4
EB 102-A		Model Number System	19
Performance Curve	23	Modes of Operation	17
EB 104.....	24		
EB 104-			
Specifications	25		
EB 104-A			
Performance Curve	27		
EB 104-B			
Performance Curve	28		
EB 106.....	29		

Motor	4	Resolver	
data package	19	leads	14
final data package	19	Signal Inputs	
thermostat	14	modes of operation	17
wave forms	33	Switching Frequency	5
outline drawing	20	Temperature	
Outline Drawing	20	ambient	5
Output Power	5	operating	5
PC-26614	24	Thermostat	14, 17
Performance Curve		Wave Forms	
EB-602	24	A-C voltage	33
Power Supply		current	33
fault contact	12	motor	33
Ratings	5	Wire	
Power Terminal Blocks	12	control	12
Preliminary Checks		gauge	12
AC Input Voltage	17	signal	12
DC Output Voltage	17	Wiring	6
Rating		diagram	13
Power Supply	5	National Code	6
Resistor		resolver	12
mounting	12	thermostat	12
		Wiring diagram	11
		Wiring Diagrams	7, 9

About Kollmorgen

Kollmorgen is a leading provider of motion systems and components for machine builders. Through world-class knowledge in motion, industry-leading quality and deep expertise in linking and integrating standard and custom products, Kollmorgen delivers breakthrough solutions that are unmatched in performance, reliability and ease-of-use, giving machine builders an irrefutable marketplace advantage.



Join the [Kollmorgen Developer Network](#) for product support. Ask the community questions, search the knowledge base for answers, get downloads, and suggest improvements

North America Kollmorgen

201 West Rock Road
Radford, VA 24141 USA

Web: www.kollmorgen.com
Mail: support@kollmorgen.com
Phone: 1-540-633-3545
Fax: 1-540-639-4162

Europa Kollmorgen Europe GmbH

Pempelfurtstr 1
40880 Ratingen, Germany

Web: www.kollmorgen.com
Mail: technik@kollmorgen.com
Phone: + 49-2102-9394-0
Fax: + 49 -2102-9394-3155

China & SEA Kollmorgen

Rm 302, Building 5
Lihpao Plaza, 88 Shenbin Road
Minhang District, Shanghai, China

Web: www.kollmorgen.cn
Mail: sales.asia@kollmorgen.com
Phone: + 86-400-661-2802
Fax: +86-21-6248-5367

KOLLMORGEN[®]

Because Motion Matters™