

Kollmorgen Automation Suite

KAS Reference Manual - PLC Library



Document Edition: P, June 2020

Valid for KAS Software Revision 3.04

Part Number: 959717



For safe and proper use, follow these instructions. Keep for future use.

Trademarks and Copyrights

Copyrights

Copyright © 2009-2020 Kollmorgen

Information in this document is subject to change without notice. The software package described in this document is furnished under a license agreement. The software package may be used or copied only in accordance with the terms of the license agreement.

This document is the intellectual property of Kollmorgen and contains proprietary and confidential information. The reproduction, modification, translation or disclosure to third parties of this document (in whole or in part) is strictly prohibited without the prior written permission of Kollmorgen.

Trademarks

- KAS and AKD are registered trademarks of [Kollmorgen](#).
- [Kollmorgen](#) is part of the [Altra Industrial Motion](#) Company.
- EnDat is a registered trademark of Dr. Johannes Heidenhain GmbH
- EtherCAT is a registered trademark and patented technology, licensed by Beckhoff Automation GmbH
- Ethernet/IP is a registered trademark of ODVA, Inc.
- Ethernet/IP Communication Stack: copyright (c) 2009, Rockwell Automation
- HIPERFACE is a registered trademark of Max Stegmann GmbH
- PROFINET is a registered trademark of PROFIBUS and PROFINET International (PI)
- SIMATIC is a registered trademark of SIEMENS AG
- Windows is a registered trademark of Microsoft Corporation
- [PLCopen](#) is an independent association providing efficiency in industrial automation.
- Codemeter is a registered trademark of [WIBU-Systems AG](#).
- SyCon® is a registered trademark of [Hilscher GmbH](#).

Kollmorgen Automation Suite is based on the work of:

- [Qt](#) cross-platform SDK (distributed under the terms of the LGPL3; Qt source is available on KDN)
- [Qwt](#) project (distributed under the [terms](#) of the GNU Lesser General Public License - see also [GPL terms](#))
- [Zlib](#) software library
- [curl](#) software library
- [Mongoose](#) software (distributed under the MIT License - [see terms](#))
- [JsonCpp](#) software (distributed under the MIT License - [see terms](#))
- [U-Boot](#), a universal boot loader is used by the AKD PDMM and PCMM (distributed under the [terms](#) of the GNU General Public License). The U-Boot source files, copyright notice, and readme are available on the distribution disk that is included with the AKD PDMM and PCMM.

All other product and brand names listed in this document may be trademarks or registered trademarks of their respective owners.

Disclaimer

The information in this document (Version P published on 6/19/2020) is believed to be accurate and reliable at the time of its release. Notwithstanding the foregoing, Kollmorgen assumes no responsibility for any damage or loss resulting from the use of this help, and expressly disclaims any liability or damages for loss of data, loss of use, and property damage of any kind, direct, incidental or consequential, in regard to or arising out of the performance or form of the materials presented herein or in any software programs that accompany this document.

All timing diagrams, whether produced by Kollmorgen or included by courtesy of the PLCopen organization, are provided with accuracy on a best-effort basis with no warranty, explicit or implied, by Kollmorgen. The user releases Kollmorgen from any liability arising out of the use of these timing diagrams.

1 Table of Contents

1	Table of Contents	3
2	Programming Languages	32
2.1	Sequential Function Chart (SFC)	32
2.1.1	SFC Execution at Runtime	33
2.1.2	Hierarchy of SFC programs	34
2.1.3	Controlling a SFC child program	35
2.2	Function Block Diagram (FBD)	36
2.2.1	Data flow	36
2.2.2	FFLD symbols	36
2.3	Instruction List (IL)	37
2.3.1	Comments	37
2.3.2	Data flow	37
2.3.3	Evaluation of expressions	38
2.3.4	Actions	39
2.4	Structured Text (ST)	40
2.4.1	Comments	40
2.4.2	Expressions	40
2.4.3	Statements	40
2.5	Free Form Ladder Diagram (FFLD)	43
2.5.1	Use of the "EN" input and the "ENO" output for blocks	43
2.5.2	Contacts and coils	44
2.5.2.1	FFLD Contacts	45
2.5.2.2	FFLD Coils	47
3	PLC Standard Libraries	49
3.1	Basic Operations	50
3.1.1	:=	51
3.1.1.1	Inputs	51
3.1.1.2	Outputs	51
3.1.1.3	Remarks	51
3.1.1.4	ST Language	51
3.1.1.5	FBD Language	51
3.1.1.6	FFLD Language	51
3.1.1.7	IL Language:	51
3.1.2	Access to Bits of an Integer	52
3.1.3	Differences Between Functions and Function Blocks	52
3.1.4	Calling a Sub-Program	52
3.1.4.1	ST Language	52
3.1.4.2	FBD and FFLD Languages	53
3.1.4.3	IL Language	53
3.1.5	CASE OF ELSE END_CASE	54
3.1.5.1	Syntax	54
3.1.5.2	Remarks	54
3.1.5.3	ST Language	54
3.1.5.4	FBD Language	54

3.1.5.5 FFLD Language	54
3.1.5.6 IL Language	54
3.1.6 COUNTOF	55
3.1.6.1 Inputs	55
3.1.6.2 Outputs	55
3.1.6.3 Remarks	55
3.1.6.4 ST Language	55
3.1.6.5 FBD Language	55
3.1.6.6 FFLD Language	55
3.1.6.7 IL Language	55
3.1.7 DEC	56
3.1.7.1 Inputs	56
3.1.7.2 Outputs	56
3.1.7.3 Remarks	56
3.1.7.4 ST Language	56
3.1.7.5 FBD Language	56
3.1.7.6 FFLD Language	56
3.1.7.7 IL Language	56
3.1.8 EXIT	57
3.1.8.1 Remarks	57
3.1.8.2 ST Language	57
3.1.8.3 FBD Language	57
3.1.8.4 FFLD Language	57
3.1.8.5 IL Language	57
3.1.9 FOR TO BY END_FOR	58
3.1.9.1 Syntax	58
3.1.9.2 Remarks	58
3.1.9.3 ST Language	58
3.1.9.4 FBD Language	58
3.1.9.5 FFLD Language	58
3.1.9.6 IL Language	58
3.1.10 IF THEN ELSE ELSIF END_IF	59
3.1.10.1 Syntax	59
3.1.10.2 Remarks	59
3.1.10.3 ST Language	59
3.1.10.4 FBD Language	59
3.1.10.5 FFLD Language	59
3.1.10.6 IL Language	59
3.1.11 INC	61
3.1.11.1 Inputs	61
3.1.11.2 Outputs	61
3.1.11.3 Remarks	61
3.1.11.4 ST Language	61
3.1.11.5 FBD Language	61
3.1.11.6 FFLD Language	61
3.1.11.7 IL Language	61
3.1.12 MOVEBLOCK	62

3.1.12.1	Inputs	62
3.1.12.2	Outputs	62
3.1.12.3	Remarks	62
3.1.12.4	ST Language	62
3.1.12.5	FBD Language	62
3.1.12.6	FFLD Language	62
3.1.12.7	IL Language	63
3.1.13	NEG -	64
3.1.13.1	Inputs	64
3.1.13.2	Outputs	64
3.1.13.3	Truth table (examples)	64
3.1.13.4	Remarks	64
3.1.13.5	ST Language	64
3.1.13.6	FBD Language	64
3.1.13.7	FFLD Language	64
3.1.14	ON	65
3.1.14.1	Syntax	65
3.1.14.2	Remarks	65
3.1.14.3	ST Language	65
3.1.15	()	66
3.1.15.1	Remarks	66
3.1.15.2	ST Language	66
3.1.15.3	FBD Language	66
3.1.15.4	FFLD Language	66
3.1.15.5	IL Language	66
3.1.16	REPEAT UNTIL END_REPEAT	67
3.1.16.1	Syntax	67
3.1.16.2	Remarks	67
3.1.16.3	ST Language	67
3.1.16.4	FBD Language	67
3.1.16.5	FFLD Language	67
3.1.16.6	IL Language	67
3.1.17	RETURN RET RETC RETNC RETCN	68
3.1.17.1	Remarks	68
3.1.17.2	ST Language	68
3.1.17.3	FBD Language	68
3.1.17.4	FFLD Language	68
3.1.17.5	IL Language	68
3.1.18	WAIT / WAIT_TIME	70
3.1.18.1	Syntax	70
3.1.18.2	Remarks	70
3.1.18.3	ST Language	70
3.1.19	WHILE DO END_WHILE	71
3.1.19.1	Syntax	71
3.1.19.2	Remarks	71
3.1.19.3	ST Language	71
3.1.19.4	FBD Language	71

3.1.19.5 FFLD Language	71
3.1.19.6 IL Language	71
3.2 Boolean operations	72
3.2.1 FLIPFLOP	73
3.2.1.1 Inputs	73
3.2.1.2 Outputs	73
3.2.1.3 Remarks	73
3.2.1.4 ST Language	73
3.2.1.5 FBD Language	73
3.2.1.6 FFLD Language	73
3.2.1.7 IL Language	73
3.2.2 F_TRIG	74
3.2.2.1 Inputs	74
3.2.2.2 Outputs	74
3.2.2.3 Truth table	74
3.2.2.4 Remarks	74
3.2.2.5 ST Language	74
3.2.2.6 FBD Language	74
3.2.2.7 FFLD Language	74
3.2.2.8 IL Language:	74
3.2.3 NOT	75
3.2.3.1 Inputs	75
3.2.3.2 Outputs	75
3.2.3.3 Truth table	75
3.2.3.4 Remarks	75
3.2.3.5 ST Language	75
3.2.3.6 FBD Language	75
3.2.3.7 FFLD Language	75
3.2.3.8 IL Language:	75
3.2.4 QOR	77
3.2.4.1 Inputs	77
3.2.4.2 Outputs	77
3.2.4.3 Remarks	77
3.2.4.4 ST Language	77
3.2.4.5 FBD Language	77
3.2.4.6 FFLD Language	77
3.2.4.7 IL Language	77
3.2.5 R	78
3.2.5.1 Inputs	78
3.2.5.2 Outputs	78
3.2.5.3 Truth table	78
3.2.5.4 Remarks	78
3.2.5.5 ST Language	78
3.2.5.6 FBD Language	78
3.2.5.7 FFLD Language	78
3.2.5.8 IL Language:	78
3.2.6 RS	79

3.2.6.1	Inputs	79
3.2.6.2	Outputs	79
3.2.6.3	Truth table	79
3.2.6.4	Remarks	79
3.2.6.5	ST Language	79
3.2.6.6	FBD Language	79
3.2.6.7	FFLD Language	80
3.2.6.8	IL Language:	80
3.2.7	R_TRIG	81
3.2.7.1	Inputs	81
3.2.7.2	Outputs	81
3.2.7.3	Truth table	81
3.2.7.4	Remarks	81
3.2.7.5	ST Language	81
3.2.7.6	FBD Language	81
3.2.7.7	FFLD Language	82
3.2.7.8	IL Language:	82
3.2.8	S	83
3.2.8.1	Inputs	83
3.2.8.2	Outputs	83
3.2.8.3	Truth table	83
3.2.8.4	Remarks	83
3.2.8.5	ST Language	83
3.2.8.6	FBD Language	83
3.2.8.7	FFLD Language	83
3.2.8.8	IL Language:	83
3.2.9	SEMA	84
3.2.9.1	Inputs	84
3.2.9.2	Outputs	84
3.2.9.3	Remarks	84
3.2.9.4	ST Language	84
3.2.9.5	FBD Language	84
3.2.9.6	FFLD Language	84
3.2.9.7	IL Language:	84
3.2.10	SR	85
3.2.10.1	Inputs	85
3.2.10.2	Outputs	85
3.2.10.3	Truth table	85
3.2.10.4	Remarks	85
3.2.10.5	ST Language	85
3.2.10.6	FBD Language	85
3.2.10.7	FFLD Language	86
3.2.10.8	IL Language:	86
3.2.11	XOR XORN	87
3.2.11.1	Inputs	87
3.2.11.2	Outputs	87
3.2.11.3	Truth table	87

3.2.11.4	Remarks	87
3.2.11.5	ST Language	87
3.2.11.6	FBD Language	87
3.2.11.7	FFLD Language	87
3.2.11.8	IL Language	87
3.3	Arithmetic operations	88
3.3.1	+ Addition	89
3.3.1.1	Inputs	89
3.3.1.2	Outputs	89
3.3.1.3	Remarks	89
3.3.1.4	ST Language	89
3.3.1.5	FBD Language	89
3.3.1.6	FFLD Language	89
3.3.1.7	IL Language	90
3.3.2	/ Divide	91
3.3.2.1	Inputs	91
3.3.2.2	Outputs	91
3.3.2.3	Remarks	91
3.3.2.4	ST Language	91
3.3.2.5	FBD Language	91
3.3.2.6	FFLD Language	91
3.3.2.7	IL Language:	91
3.3.3	NEG -	92
3.3.3.1	Inputs	92
3.3.3.2	Outputs	92
3.3.3.3	Truth table (examples)	92
3.3.3.4	Remarks	92
3.3.3.5	ST Language	92
3.3.3.6	FBD Language	92
3.3.3.7	FFLD Language	92
3.3.4	LIMIT	93
3.3.4.1	Inputs	93
3.3.4.2	Outputs	93
3.3.4.3	Function diagram	93
3.3.4.4	Remarks	93
3.3.4.5	ST Language	93
3.3.4.6	FBD Language	93
3.3.4.7	FFLD Language	93
3.3.4.8	IL Language:	94
3.3.5	MAX	95
3.3.5.1	Inputs	95
3.3.5.2	Outputs	95
3.3.5.3	Remarks	95
3.3.5.4	ST Language	95
3.3.5.5	FBD Language	95
3.3.5.6	FFLD Language	95
3.3.5.7	IL Language:	95

3.3.6 MIN	96
3.3.6.1 Inputs	96
3.3.6.2 Outputs	96
3.3.6.3 Remarks	96
3.3.6.4 ST Language	96
3.3.6.5 FBD Language	96
3.3.6.6 FFLD Language	96
3.3.6.7 IL Language:	96
3.3.7 MOD / MODR / MODLR	97
3.3.7.1 Examples	97
3.3.7.2 Remarks	98
3.3.7.3 ST Language	98
3.3.7.4 FBD Language	98
3.3.7.5 FFLD Language	98
3.3.7.6 IL Language	99
3.3.8 * Multiply	100
3.3.8.1 Inputs	100
3.3.8.2 Outputs	100
3.3.8.3 Remarks	100
3.3.8.4 ST Language	100
3.3.8.5 FBD Language	100
3.3.8.6 FFLD Language	100
3.3.8.7 IL Language:	100
3.3.9 ODD	101
3.3.9.1 Inputs	101
3.3.9.2 Outputs	101
3.3.9.3 Remarks	101
3.3.9.4 ST Language	101
3.3.9.5 FBD Language	101
3.3.9.6 FFLD Language	101
3.3.9.7 IL Language:	101
3.3.10 SetWithin	102
3.3.10.1 Inputs	102
3.3.10.2 Outputs	102
3.3.10.3 Truth Table	102
3.3.10.4 Remarks	102
3.3.11 - Subtraction	103
3.3.11.1 Inputs	103
3.3.11.2 Outputs	103
3.3.11.3 Remarks	103
3.3.11.4 ST Language	103
3.3.11.5 FBD Language	103
3.3.11.6 FFLD Language	103
3.3.11.7 IL Language:	103
3.4 Comparison Operations	104
3.4.1 CMP	105
3.4.1.1 Inputs	105

3.4.1.2	Outputs	105
3.4.1.3	Remarks	105
3.4.1.4	ST Language	105
3.4.1.5	FBD Language	105
3.4.1.6	FFLD Language	105
3.4.1.7	IL Language:	105
3.4.2	>= GE	106
3.4.2.1	Inputs	106
3.4.2.2	Outputs	106
3.4.2.3	Remarks	106
3.4.2.4	ST Language	106
3.4.2.5	FBD Language	106
3.4.2.6	FFLD Language	106
3.4.2.7	IL Language:	106
3.4.3	> GT	107
3.4.3.1	Inputs	107
3.4.3.2	Outputs	107
3.4.3.3	Remarks	107
3.4.3.4	ST Language	107
3.4.3.5	FBD Language	107
3.4.3.6	FFLD Language	107
3.4.3.7	IL Language:	107
3.4.4	= EQ	108
3.4.4.1	Inputs	108
3.4.4.2	Outputs	108
3.4.4.3	Remarks	108
3.4.4.4	ST Language	108
3.4.4.5	FBD Language	108
3.4.4.6	FFLD Language	108
3.4.4.7	IL Language:	108
3.4.5	<> NE	109
3.4.5.1	Inputs	109
3.4.5.2	Outputs	109
3.4.5.3	Remarks	109
3.4.5.4	ST Language	109
3.4.5.5	FBD Language	109
3.4.5.6	FFLD Language	109
3.4.5.7	IL Language:	109
3.4.6	<= LE	110
3.4.6.1	Inputs	110
3.4.6.2	Outputs	110
3.4.6.3	Remarks	110
3.4.6.4	ST Language	110
3.4.6.5	FBD Language	110
3.4.6.6	FFLD Language	110
3.4.6.7	IL Language:	110
3.4.7	< LT	111

3.4.7.1	Inputs	111
3.4.7.2	Outputs	111
3.4.7.3	Remarks	111
3.4.7.4	ST Language	111
3.4.7.5	FBD Language	111
3.4.7.6	FFLD Language	111
3.4.7.7	IL Language:	111
3.5	Type conversion functions	112
3.5.1	ANY_TO_BOOL	113
3.5.1.1	Inputs	113
3.5.1.2	Outputs	113
3.5.1.3	Remarks	113
3.5.1.4	ST Language	113
3.5.1.5	FBD Language	113
3.5.1.6	FFLD Language	113
3.5.1.7	IL Language:	113
3.5.1.8	See also	113
3.5.2	ANY_TO_DINT / ANY_TO_UDINT	114
3.5.2.1	Inputs	114
3.5.2.2	Outputs	114
3.5.2.3	Remarks	114
3.5.2.4	ST Language	114
3.5.2.5	FBD Language	114
3.5.2.6	FFLD Language	114
3.5.2.7	IL Language:	114
3.5.2.8	See also	114
3.5.3	ANY_TO_INT / ANY_TO_UINT	115
3.5.3.1	Inputs	115
3.5.3.2	Outputs	115
3.5.3.3	Remarks	115
3.5.3.4	ST Language	115
3.5.3.5	FBD Language	115
3.5.3.6	FFLD Language	115
3.5.3.7	IL Language:	115
3.5.3.8	See also	115
3.5.4	ANY_TO_LINT / ANY_TO_ULINT	116
3.5.4.1	Inputs	116
3.5.4.2	Outputs	116
3.5.4.3	Remarks	116
3.5.4.4	ST Language	116
3.5.4.5	FBD Language	116
3.5.4.6	FFLD Language	116
3.5.4.7	IL Language:	116
3.5.4.8	See also	116
3.5.5	ANY_TO_LREAL	117
3.5.5.1	Inputs	117
3.5.5.2	Outputs	117

3.5.5.3	Remarks	117
3.5.5.4	ST Language	117
3.5.5.5	FBD Language	117
3.5.5.6	FFLD Language	117
3.5.5.7	IL Language:	117
3.5.5.8	See also	117
3.5.6	ANY_TO_REAL	118
3.5.6.1	Inputs	118
3.5.6.2	Outputs	118
3.5.6.3	Remarks	118
3.5.6.4	ST Language	118
3.5.6.5	FBD Language	118
3.5.6.6	FFLD Language	118
3.5.6.7	IL Language:	118
3.5.6.8	See also	118
3.5.7	ANY_TO_TIME	119
3.5.7.1	Inputs	119
3.5.7.2	Outputs	119
3.5.7.3	Remarks	119
3.5.7.4	ST Language	119
3.5.7.5	FBD Language	119
3.5.7.6	FFLD Language	119
3.5.7.7	IL Language:	119
3.5.7.8	See also	119
3.5.8	ANY_TO_SINT / ANY_TO_USINT	120
3.5.8.1	Inputs	120
3.5.8.2	Outputs	120
3.5.8.3	Remarks	120
3.5.8.4	ST Language	120
3.5.8.5	FBD Language	120
3.5.8.6	FFLD Language	120
3.5.8.7	IL Language	120
3.5.8.8	See also	120
3.5.9	ANY_TO_STRING	121
3.5.9.1	Inputs	121
3.5.9.2	Outputs	121
3.5.9.3	Remarks	121
3.5.9.4	ST Language	121
3.5.9.5	FBD Language	121
3.5.9.6	FFLD Language	121
3.5.9.7	IL Language:	121
3.5.9.8	See also	121
3.5.10	NUM_TO_STRING	122
3.5.10.1	Inputs	122
3.5.10.2	Outputs	122
3.5.10.3	Remarks	122
3.5.10.4	Examples	122

3.5.11 BCD_TO_BIN	123
3.5.11.1 Inputs	123
3.5.11.2 Outputs	123
3.5.11.4 Remarks	123
3.5.11.5 ST Language	123
3.5.11.6 FBD Language	123
3.5.11.7 FFLD Language	123
3.5.11.8 IL Language	123
3.5.12 BIN_TO_BCD	124
3.5.12.1 Inputs	124
3.5.12.2 Outputs	124
3.5.12.3 Truth table (examples)	124
3.5.12.4 Remarks	124
3.5.12.5 ST Language	124
3.5.12.6 FBD Language	124
3.5.12.7 FFLD Language	124
3.5.12.8 IL Language:	124
3.6 Selectors	125
3.6.1 MUX4	126
3.6.1.1 Inputs	126
3.6.1.2 Outputs	126
3.6.1.3 Truth table	126
3.6.1.4 Remarks	126
3.6.1.5 ST Language	126
3.6.1.6 FBD Language	126
3.6.1.7 FFLD Language	126
3.6.1.8 IL Language	127
3.6.2 MUX8	128
3.6.2.1 Inputs	128
3.6.2.2 Outputs	128
3.6.2.3 Truth table	128
3.6.2.4 Remarks	128
3.6.2.5 ST Language	128
3.6.2.6 FBD Language	128
3.6.2.7 FFLD Language	128
3.6.2.8 IL Language	129
3.6.3 SEL	130
3.6.3.1 Inputs	130
3.6.3.2 Outputs	130
3.6.3.3 Truth table	130
3.6.3.4 Remarks	130
3.6.3.5 ST Language	130
3.6.3.6 FBD Language	130
3.6.3.7 FFLD Language	130
3.6.3.8 IL Language	130
3.7 Registers	131
3.7.1 AND_MASK	132

3.7.1.1	Inputs	132
3.7.1.2	Outputs	132
3.7.1.3	Remarks	132
3.7.1.4	ST Language	132
3.7.1.5	FBD Language	132
3.7.1.6	FFLD Language	132
3.7.1.7	IL Language:	132
3.7.2	HIBYTE	133
3.7.2.1	Inputs	133
3.7.2.2	Outputs	133
3.7.2.3	Remarks	133
3.7.2.4	ST Language	133
3.7.2.5	FBD Language	133
3.7.2.6	FFLD Language	133
3.7.2.7	IL Language:	133
3.7.3	LOBYTE	134
3.7.3.1	Inputs	134
3.7.3.2	Outputs	134
3.7.3.3	Remarks	134
3.7.3.4	ST Language	134
3.7.3.5	FBD Language	134
3.7.3.6	FFLD Language	134
3.7.3.7	IL Language:	134
3.7.4	HIWORD	135
3.7.4.1	Inputs	135
3.7.4.2	Outputs	135
3.7.4.3	Remarks	135
3.7.4.4	ST Language	135
3.7.4.5	FBD Language	135
3.7.4.6	FFLD Language	135
3.7.4.7	IL Language:	135
3.7.5	LOWORD	136
3.7.5.1	Inputs	136
3.7.5.2	Outputs	136
3.7.5.3	Remarks	136
3.7.5.4	ST Language	136
3.7.5.5	FBD Language	136
3.7.5.6	FFLD Language	136
3.7.5.7	IL Language:	136
3.7.6	MAKEDWORD	137
3.7.6.1	Inputs	137
3.7.6.2	Outputs	137
3.7.6.3	Remarks	137
3.7.6.4	ST Language	137
3.7.6.5	FBD Language	137
3.7.6.6	FFLD Language	137
3.7.6.7	IL Language:	137

3.7.7 MAKEWORD	138
3.7.7.1 Inputs	138
3.7.7.2 Outputs	138
3.7.7.3 Remarks	138
3.7.7.4 ST Language	138
3.7.7.5 FBD Language	138
3.7.7.6 FFLD Language	138
3.7.7.7 IL Language:	138
3.7.8 MBSHIFT	139
3.7.8.1 Inputs	139
3.7.8.2 Outputs	139
3.7.8.3 Remarks	139
3.7.8.4 ST Language	139
3.7.8.5 FBD Language	139
3.7.8.6 FFLD Language	139
3.7.8.7 IL Language:	139
3.7.9 NOT_MASK	140
3.7.9.1 Inputs	140
3.7.9.2 Outputs	140
3.7.9.3 Remarks	140
3.7.9.4 ST Language	140
3.7.9.5 FBD Language	140
3.7.9.6 FFLD Language	140
3.7.9.7 IL Language:	140
3.7.10 OR_MASK	141
3.7.10.1 Inputs	141
3.7.10.2 Outputs	141
3.7.10.3 Remarks	141
3.7.10.4 ST Language	141
3.7.10.5 FBD Language	141
3.7.10.6 FFLD Language	141
3.7.10.7 IL Language:	141
3.7.11 PACK8	142
3.7.11.1 Inputs	142
3.7.11.2 Outputs	142
3.7.11.3 Remarks	142
3.7.11.4 ST Language	142
3.7.11.5 FBD Language	142
3.7.11.6 FFLD Language	143
3.7.11.7 IL Language	143
3.7.12 ROL	144
3.7.12.1 Inputs	144
3.7.12.2 Outputs	144
3.7.12.3 Diagram	144
3.7.12.4 Remarks	144
3.7.12.5 ST Language	144
3.7.12.6 FBD Language	144

3.7.12.7	FFLD Language	144
3.7.12.8	IL Language:	144
3.7.13	ROR	145
3.7.13.1	Inputs	145
3.7.13.2	Outputs	145
3.7.13.3	Diagram	145
3.7.13.4	Remarks	145
3.7.13.5	ST Language	145
3.7.13.6	FBD Language	145
3.7.13.7	FFLD Language	145
3.7.13.8	IL Language:	145
3.7.14	RORb / ROR_SINT / ROR_USINT / ROR_BYTE	146
3.7.14.1	Inputs	146
3.7.14.2	Outputs	146
3.7.14.3	Diagram	146
3.7.14.4	Remarks	146
3.7.14.5	ST Language	146
3.7.14.6	FBD Language	146
3.7.14.7	FFLD Language	146
3.7.14.8	IL Language:	146
3.7.14.9	See also	146
3.7.15	RORw / ROR_INT / ROR_UINT / ROR_WORD	147
3.7.15.1	Inputs	147
3.7.15.2	Outputs	147
3.7.15.3	Diagram	147
3.7.15.4	Remarks	147
3.7.15.5	ST Language	147
3.7.15.6	FBD Language	147
3.7.15.7	FFLD Language	147
3.7.15.8	IL Language:	147
3.7.15.9	See also	147
3.7.16	SETBIT	148
3.7.16.1	Inputs	148
3.7.16.2	Outputs	148
3.7.16.3	Remarks	148
3.7.16.4	ST Language	148
3.7.16.5	FBD Language	148
3.7.16.6	FFLD Language	148
3.7.16.7	IL Language	148
3.7.17	SHL	149
3.7.17.1	Inputs	149
3.7.17.2	Outputs	149
3.7.17.3	Diagram	149
3.7.17.4	Remarks	149
3.7.17.5	ST Language	149
3.7.17.6	FBD Language	149
3.7.17.7	FFLD Language	149

3.7.17.8 IL Language:	149
3.7.18 SHR	150
3.7.18.1 Inputs	150
3.7.18.2 Outputs	150
3.7.18.3 Diagram	150
3.7.18.4 Remarks	150
3.7.18.5 ST Language	150
3.7.18.6 FBD Language	150
3.7.18.7 FFLD Language	150
3.7.18.8 IL Language:	150
3.7.19 TESTBIT	151
3.7.19.1 Inputs	151
3.7.19.2 Outputs	151
3.7.19.3 Remarks	151
3.7.19.4 ST Language	151
3.7.19.5 FBD Language	151
3.7.19.6 FFLD Language	151
3.7.19.7 IL Language	151
3.7.20 UNPACK8	152
3.7.20.1 Inputs	152
3.7.20.2 Outputs	152
3.7.20.3 Remarks	152
3.7.20.4 ST Language	152
3.7.20.5 FBD Language	152
3.7.20.6 FFLD Language	152
3.7.20.7 IL Language:	153
3.7.21 XOR_MASK	154
3.7.21.1 Inputs	154
3.7.21.2 Outputs	154
3.7.21.3 Remarks	154
3.7.21.4 ST Language	154
3.7.21.5 FBD Language	154
3.7.21.6 FFLD Language	154
3.7.21.7 IL Language:	154
3.8 Counters	155
3.8.1 CTD / CTD _r	156
3.8.1.1 Inputs	156
3.8.1.2 Outputs	156
3.8.1.3 Remarks	156
3.8.1.4 ST Language	156
3.8.1.5 FBD Language	156
3.8.1.6 FFLD Language	156
3.8.1.7 IL Language:	156
3.8.2 CTU / CTU _r	157
3.8.2.1 Inputs	157
3.8.2.2 Outputs	157
3.8.2.3 Remarks	157

3.8.2.4 ST Language	157
3.8.2.5 FBD Language	157
3.8.2.6 FFLD Language	157
3.8.2.7 IL Language:	157
3.8.3 CTUD / CTUDr	158
3.8.3.1 Inputs	158
3.8.3.2 Outputs	158
3.8.3.3 Remarks	158
3.8.3.4 ST Language	158
3.8.3.5 FBD Language	158
3.8.3.6 FFLD Language	159
3.8.3.7 IL Language:	159
3.9 Timers	160
3.9.1 BLINK	161
3.9.1.1 Inputs	161
3.9.1.2 Outputs	161
3.9.1.3 Time diagram	161
3.9.1.4 Remarks	161
3.9.1.5 ST Language	161
3.9.1.6 FBD Language	161
3.9.1.7 FFLD Language	161
3.9.1.8 IL Language	161
3.9.2 BLINKA	162
3.9.2.1 Inputs	162
3.9.2.2 Outputs	162
3.9.2.3 Time diagram	162
3.9.2.4 Remarks	162
3.9.2.5 ST Language	162
3.9.2.6 FBD Language	162
3.9.2.7 FFLD Language	162
3.9.2.8 IL Language:	163
3.9.3 PLS	164
3.9.3.1 Inputs	164
3.9.3.2 Outputs	164
3.9.3.3 Time diagram	164
3.9.3.4 Remarks	164
3.9.3.5 ST Language	164
3.9.3.6 FBD Language	164
3.9.3.7 FFLD Language	164
3.9.3.8 IL Language	165
3.9.4 Sig_Gen	166
3.9.4.1 Inputs	166
3.9.4.2 Outputs	166
3.9.4.3 FFLD Language	166
3.9.5 TMD	167
3.9.5.1 Inputs	167
3.9.5.2 Outputs	167

3.9.5.3	Time diagram	167
3.9.5.4	Remarks	167
3.9.5.5	ST Language	167
3.9.5.6	FBD Language	167
3.9.5.7	FFLD Language	167
3.9.5.8	IL Language	168
3.9.6	TMU / TMUsec	169
3.9.6.1	Inputs	169
3.9.6.2	Outputs	169
3.9.6.3	Time diagram	169
3.9.6.4	Remarks	169
3.9.6.5	ST Language	169
3.9.6.6	FBD Language	169
3.9.6.7	FFLD Language	170
3.9.6.8	IL Language:	170
3.9.7	TOF / TOFR	171
3.9.7.1	Inputs	171
3.9.7.2	Outputs	171
3.9.7.3	Time diagram	171
3.9.7.4	Remarks	171
3.9.7.5	ST Language	171
3.9.7.6	FBD Language	171
3.9.7.7	FFLD Language	171
3.9.7.8	IL Language:	172
3.9.8	TON	173
3.9.8.1	Inputs	173
3.9.8.2	Outputs	173
3.9.8.3	Time diagram	173
3.9.8.4	Remarks	173
3.9.8.5	ST Language	173
3.9.8.6	FBD Language	173
3.9.8.7	FFLD Language	174
3.9.8.8	IL Language:	174
3.9.9	TP / TPR	175
3.9.9.1	Inputs	175
3.9.9.2	Outputs	175
3.9.9.3	Time diagram	175
3.9.9.4	Remarks	175
3.9.9.5	ST Language	175
3.9.9.6	FBD Language	175
3.9.9.7	FFLD Language	175
3.9.9.8	IL Language:	176
3.10	Mathematic operations	177
3.10.1	ABS / ABSL	178
3.10.1.1	Inputs	178
3.10.1.2	Outputs	178
3.10.1.3	Remarks	178

3.10.1.4	ST Language	178
3.10.1.5	FBD Language	178
3.10.1.6	FFLD Language	178
3.10.1.7	IL Language	178
3.10.2	EXPT	179
3.10.2.1	Inputs	179
3.10.2.2	Outputs	179
3.10.2.3	Remarks	179
3.10.2.4	ST Language	179
3.10.2.5	FBD Language	179
3.10.2.6	FFLD Language	179
3.10.2.7	IL Language:	179
3.10.3	EXP / EXPL	180
3.10.3.1	Inputs	180
3.10.3.2	Outputs	180
3.10.3.3	Remarks	180
3.10.3.4	ST Language	180
3.10.3.5	FBD Language	180
3.10.3.6	FFLD Language	180
3.10.3.7	IL Language:	180
3.10.4	LOG / LOGL	181
3.10.4.1	Inputs	181
3.10.4.2	Outputs	181
3.10.4.3	Remarks	181
3.10.4.4	ST Language	181
3.10.4.5	FBD Language	181
3.10.4.6	FFLD Language	181
3.10.4.7	IL Language:	181
3.10.5	LN / LNL	182
3.10.5.1	Inputs	182
3.10.5.2	Outputs	182
3.10.5.3	Remarks	182
3.10.5.4	ST Language	182
3.10.5.5	FBD Language	182
3.10.5.6	FFLD Language	182
3.10.5.7	IL Language:	182
3.10.6	POW ** POWL	183
3.10.6.1	Inputs	183
3.10.6.2	Outputs	183
3.10.6.3	Remarks	183
3.10.6.4	ST Language	183
3.10.6.5	FBD Language	183
3.10.6.6	FFLD Language	183
3.10.6.7	IL Language:	183
3.10.7	ROOT	184
3.10.7.1	Inputs	184
3.10.7.2	Outputs	184

3.10.7.3	Remarks	184
3.10.7.4	ST Language	184
3.10.7.5	FBD Language	184
3.10.7.6	FFLD Language	184
3.10.7.7	IL Language:	184
3.10.8	ScaleLin	185
3.10.8.1	Inputs	185
3.10.8.2	Outputs	185
3.10.8.3	Truth table	185
3.10.8.4	Remarks	185
3.10.8.5	ST Language	185
3.10.8.6	FBD Language	185
3.10.8.7	FFLD Language	185
3.10.8.8	IL Language	186
3.10.9	SQRT / SQRTL	187
3.10.9.1	Inputs	187
3.10.9.2	Outputs	187
3.10.9.3	Remarks	187
3.10.9.4	ST Language	187
3.10.9.5	FBD Language	187
3.10.9.6	FFLD Language	187
3.10.9.7	IL Language:	187
3.10.10	TRUNC / TRUNCL	188
3.10.10.1	Inputs	188
3.10.10.2	Outputs	188
3.10.10.3	Remarks	188
3.10.10.4	ST Language	188
3.10.10.5	FBD Language	188
3.10.10.6	FFLD Language	188
3.10.10.7	IL Language:	188
3.11	Trigonometric functions	189
3.11.1	ACOS / ACOSL	190
3.11.1.1	Inputs	190
3.11.1.2	Outputs	190
3.11.1.3	Remarks	190
3.11.1.4	ST Language	190
3.11.1.5	FBD Language	190
3.11.1.6	FFLD Language	190
3.11.1.7	IL Language:	190
3.11.2	ASIN / ASINL	191
3.11.2.1	Inputs	191
3.11.2.2	Outputs	191
3.11.2.3	Remarks	191
3.11.2.4	ST Language	191
3.11.2.5	FBD Language	191
3.11.2.6	FFLD Language	191
3.11.2.7	IL Language:	191

3.11.3 ATAN / ATANL	192
3.11.3.1 Inputs	192
3.11.3.2 Outputs	192
3.11.3.3 Remarks	192
3.11.3.4 ST Language	192
3.11.3.5 FBD Language	192
3.11.3.6 FFLD Language	192
3.11.3.7 IL Language:	192
3.11.4 ATAN2 / ATAN2L	193
3.11.4.1 Inputs	193
3.11.4.2 Outputs	193
3.11.4.3 Remarks	193
3.11.4.4 ST Language	193
3.11.4.5 FBD Language	193
3.11.4.6 FFLD Language	193
3.11.4.7 IL Language	193
3.11.5 COS / COSL	194
3.11.5.1 Inputs	194
3.11.5.2 Outputs	194
3.11.5.3 Remarks	194
3.11.5.4 ST Language	194
3.11.5.5 FBD Language	194
3.11.5.6 FFLD Language	194
3.11.5.7 IL Language:	194
3.11.6 SIN / SINL	195
3.11.6.1 Inputs	195
3.11.6.2 Outputs	195
3.11.6.3 Remarks	195
3.11.6.4 ST Language	195
3.11.6.5 FBD Language	195
3.11.6.6 FFLD Language	195
3.11.6.7 IL Language:	195
3.11.7 TAN / TANL	196
3.11.7.1 Inputs	196
3.11.7.2 Outputs	196
3.11.7.3 Remarks	196
3.11.7.4 ST Language	196
3.11.7.5 FBD Language	196
3.11.7.6 FFLD Language	196
3.11.7.7 IL Language:	196
3.11.8 UseDegrees	197
3.11.8.1 Inputs	197
3.11.8.2 Outputs	197
3.11.8.3 Remarks	197
3.11.8.4 ST Language	197
3.11.8.5 FBD Language	197
3.11.8.6 FFLD Language	197

3.11.8.7 IL Language	197
3.12 String operations	198
3.12.1 ArrayToString / ArrayToStringU	199
3.12.1.1 Inputs	199
3.12.1.2 Outputs	199
3.12.1.3 Remarks	199
3.12.1.4 ST Language	199
3.12.1.5 FBD Language	199
3.12.1.6 FFLD Language	199
3.12.1.7 IL Language	199
3.12.2 ASCII	200
3.12.2.1 Inputs	200
3.12.2.2 Outputs	200
3.12.2.3 Remarks	200
3.12.2.4 ST Language	200
3.12.2.5 FBD Language	200
3.12.2.6 FFLD Language	200
3.12.2.7 IL Language:	200
3.12.3 ATOH	201
3.12.3.1 Inputs	201
3.12.3.2 Outputs	201
3.12.3.3 Truth table (examples)	201
3.12.3.4 Remarks	201
3.12.3.5 ST Language	201
3.12.3.6 FBD Language	201
3.12.3.7 FFLD Language	201
3.12.3.8 IL Language:	201
3.12.4 CHAR	202
3.12.4.1 Inputs	202
3.12.4.2 Outputs	202
3.12.4.3 Remarks	202
3.12.4.4 ST Language	202
3.12.4.5 FBD Language	202
3.12.4.6 FFLD Language	202
3.12.4.7 IL Language:	202
3.12.5 CONCAT	203
3.12.5.1 Inputs	203
3.12.5.2 Outputs	203
3.12.5.3 Remarks	203
3.12.5.4 ST Language	203
3.12.5.5 FBD Language	203
3.12.5.6 FFLD Language	203
3.12.5.7 IL Language	203
3.12.6 CRC16	204
3.12.6.1 Inputs	204
3.12.6.2 Outputs	204
3.12.6.3 Remarks	204

3.12.6.4 ST Language	204
3.12.6.5 FBD Language	204
3.12.6.6 FFLD Language	204
3.12.6.7 IL Language:	204
3.12.7 DELETE	205
3.12.7.1 Inputs	205
3.12.7.2 Outputs	205
3.12.7.3 Remarks	205
3.12.7.4 ST Language	205
3.12.7.5 FBD Language	205
3.12.7.6 FFLD Language	205
3.12.7.7 IL Language:	205
3.12.8 FIND	206
3.12.8.1 Inputs	206
3.12.8.2 Outputs	206
3.12.8.3 Remarks	206
3.12.8.4 ST Language	206
3.12.8.5 FBD Language	206
3.12.8.6 FFLD Language	206
3.12.8.7 IL Language:	206
3.12.9 HTOA	207
3.12.9.1 Inputs	207
3.12.9.2 Outputs	207
3.12.9.3 Truth table (examples)	207
3.12.9.4 Remarks	207
3.12.9.5 ST Language	207
3.12.9.6 FBD Language	207
3.12.9.7 FFLD Language	207
3.12.9.8 IL Language:	207
3.12.10 INSERT	208
3.12.10.1 Inputs	208
3.12.10.2 Outputs	208
3.12.10.3 Remarks	208
3.12.10.4 ST Language	208
3.12.10.5 FBD Language	208
3.12.10.6 FFLD Language	208
3.12.10.7 IL Language:	208
3.12.11 LEFT	209
3.12.11.1 Inputs	209
3.12.11.2 Outputs	209
3.12.11.3 Remarks	209
3.12.11.4 ST Language	209
3.12.11.5 FBD Language	209
3.12.11.6 FFLD Language	209
3.12.11.7 IL Language:	209
3.12.12 LoadString	210
3.12.12.1 Inputs	210

3.12.12.2	Outputs	210
3.12.12.3	Remarks	210
3.12.12.4	ST Language	210
3.12.12.5	FBD Language	210
3.12.12.6	FFLD Language	210
3.12.12.7	IL Language:	210
3.12.13	MID	211
3.12.13.1	Inputs	211
3.12.13.2	Outputs	211
3.12.13.3	Remarks	211
3.12.13.4	ST Language	211
3.12.13.5	FBD Language	211
3.12.13.6	FFLD Language	211
3.12.13.7	IL Language:	211
3.12.14	MLEN	212
3.12.14.1	Inputs	212
3.12.14.2	Outputs	212
3.12.14.3	Remarks	212
3.12.14.4	ST Language	212
3.12.14.5	FBD Language	212
3.12.14.6	FFLD Language	212
3.12.14.7	IL Language:	212
3.12.15	REPLACE	213
3.12.15.1	Inputs	213
3.12.15.2	Outputs	213
3.12.15.3	Remarks	213
3.12.15.4	ST Language	213
3.12.15.5	FBD Language	213
3.12.15.6	FFLD Language	213
3.12.15.7	IL Language:	213
3.12.16	RIGHT	214
3.12.16.1	Inputs	214
3.12.16.2	Outputs	214
3.12.16.3	Remarks	214
3.12.16.4	ST Language	214
3.12.16.5	FBD Language	214
3.12.16.6	FFLD Language	214
3.12.16.7	IL Language:	214
3.12.17	StringTable	215
3.12.17.1	Inputs	215
3.12.17.2	Outputs	215
3.12.17.3	Remarks	215
3.12.17.4	ST Language	215
3.12.17.5	FBD Language	215
3.12.17.6	FFLD Language	215
3.12.17.7	IL Language:	215
3.12.17.8	String Table Resources	216

3.12.18 StringToArray / StringToArrayU	217
3.12.18.1 Inputs	217
3.12.18.2 Outputs	217
3.12.18.3 Remarks	217
3.12.18.4 ST Language	217
3.12.18.5 FBD Language	217
3.12.18.6 FFLD Language	217
3.12.18.7 IL Language:	217
4 PLC Advanced Libraries	218
4.1 ALARM_A	220
4.1.1 Inputs	220
4.1.2 Outputs	220
4.1.3 Sequence	220
4.1.4 Remarks	220
4.1.5 ST Language	220
4.1.6 FBD Language	220
4.1.7 FFLD Language	221
4.1.8 IL Language	221
4.2 ALARM_M	222
4.2.1 Inputs	222
4.2.2 Outputs	222
4.2.3 Sequence	222
4.2.4 Remarks	222
4.2.5 ST Language	222
4.2.6 FBD Language	222
4.2.7 FFLD Language	223
4.2.8 IL Language	223
4.3 ApplyRecipeColumn	224
4.3.1 Inputs	224
4.3.2 Outputs	225
4.3.3 Remarks	225
4.3.4 ST Language	225
4.3.5 FBD Language	226
4.3.6 FFLD Language	226
4.3.7 IL Language	226
4.4 AS-interface Functions	227
4.5 AVERAGE / AVERAGEL	228
4.5.1 Inputs	228
4.5.2 Outputs	228
4.5.3 Remarks	228
4.5.4 ST Language	228
4.5.5 FBD Language	228
4.5.6 FFLD Language	228
4.5.7 IL Language:	229
4.6 CurveLin	230
4.6.1 Inputs	230
4.6.2 Outputs	230

4.6.3 Remarks	230
4.7 DERIVATE	231
4.7.1 Inputs	231
4.7.2 Outputs	231
4.7.3 Remarks	231
4.7.4 ST Language	231
4.7.5 FBD Language	231
4.7.6 FFLD Language	231
4.7.7 IL Language:	231
4.8 EnableEvents	232
4.8.1 Inputs	232
4.8.2 Outputs	232
4.8.3 Remarks	232
4.8.4 ST Language	232
4.8.5 FBD Language	232
4.8.6 FFLD Language	232
4.8.7 IL Language:	232
4.9 FIFO	233
4.9.1 Inputs	233
4.9.2 Outputs	233
4.9.3 Remarks	233
4.9.4 ST Language	234
4.9.5 FBD Language	234
4.9.6 FFLD Language	234
4.9.7 IL Language	234
4.10 File Management	235
4.10.1 SD Card Access	237
4.10.2 SD Card Mounting Functions	238
4.10.2.1 SD_MOUNT	238
4.10.2.2 SD_UNMOUNT	238
4.10.2.3 SD_ISREADY	238
4.10.3 File Path Conventions	239
4.10.3.1 Shared Directory Path Conventions	240
4.10.3.2 SD Card Path Conventions	241
4.10.3.3 File Name Warning & Limitations	242
4.10.4 *DEPRECATED* File Management Functions	243
4.10.5 File Management Function Examples	244
4.11 FilterOrder1	245
4.11.1 Inputs	245
4.11.2 Outputs	245
4.11.3 Remarks	245
4.11.4 ST Language	245
4.11.5 Example	245
4.12 GETSYSINFO	246
4.12.1 Inputs	246
4.12.2 Outputs	246
4.12.3 Remarks	246

4.12.4 ST Language	246
4.12.5 FBD Language	247
4.12.6 FFLD Language	247
4.12.7 IL Language:	247
4.13 HYSTER	248
4.13.1 Inputs	248
4.13.2 Outputs	248
4.13.3 Remarks	248
4.13.4 ST Language	248
4.13.5 FBD Language	248
4.13.6 FFLD Language	248
4.13.7 IL Language:	248
4.14 INTEGRAL	249
4.14.1 Inputs	249
4.14.2 Outputs	249
4.14.3 Remarks	249
4.14.4 ST Language	249
4.14.5 FBD Language	249
4.14.6 FFLD Language	249
4.14.7 IL Language:	249
4.15 LIFO	251
4.15.1 Inputs	251
4.15.2 Outputs	251
4.15.3 Remarks	251
4.15.4 ST Language	251
4.15.5 FBD Language	251
4.15.6 FFLD Language	252
4.15.7 IL Language	252
4.16 LIM_ALRM	253
4.16.1 Inputs	253
4.16.2 Outputs	253
4.16.3 Remarks	253
4.16.4 ST Language	253
4.16.5 FBD Language	253
4.16.6 FFLD Language	253
4.16.7 IL Language:	253
4.17 LogFileCSV	255
4.17.1 Inputs	255
4.17.2 Outputs	255
4.17.3 Remarks	255
4.17.4 ST Language	256
4.17.5 FBD Language	256
4.17.6 FFLD Language	256
4.17.7 IL Language	257
4.18 PID	258
4.18.1 Inputs	258
4.18.2 Outputs	258

4.18.3 Diagram	259
4.18.4 Remarks	259
4.18.5 ST Language	259
4.18.6 FBD Language	259
4.18.7 FFLD Language	260
4.18.8 IL Language	260
4.19 PWM	262
4.19.1 Inputs	262
4.19.2 Outputs	262
4.19.3 Remarks	262
4.19.4 ST Language	262
4.19.5 Example	262
4.20 RAMP	263
4.20.1 Inputs	263
4.20.2 Outputs	263
4.20.3 Time diagram	263
4.20.4 Remarks	263
4.20.5 ST Language	263
4.20.6 FBD Language	264
4.20.7 FFLD Language	264
4.20.8 IL Language	264
4.21 Real Time Clock Management Functions	265
4.21.1 DAY_TIME	267
4.21.1.1 Inputs	267
4.21.1.2 Outputs	267
4.21.1.3 Remarks	267
4.21.1.4 ST Language	267
4.21.1.5 FBD Language	267
4.21.1.6 FFLD Language	267
4.21.1.7 IL Language	267
4.21.2 DTFORMAT	268
4.21.2.1 Inputs	268
4.21.2.2 Outputs	268
4.21.2.3 Remarks	268
4.21.2.4 ST Language	268
4.21.2.5 FBD Language	268
4.21.2.6 FFLD Language	268
4.21.2.7 IL Language	268
4.21.3 DTAT	270
4.21.3.1 Inputs	270
4.21.3.2 Outputs	270
4.21.3.3 Remarks	270
4.21.3.4 ST Language	270
4.21.3.5 FBD Language	270
4.21.3.6 FFLD Language	271
4.21.3.7 IL Language:	271
4.21.4 DTEVERY	272

4.21.4.1	Inputs	272
4.21.4.2	Outputs	272
4.21.4.3	Remarks	272
4.21.4.4	ST Language	272
4.21.4.5	FBD Language	272
4.21.4.6	FFLD Language	272
4.21.4.7	IL Language:	272
4.22	SerializeIn	273
4.22.1	Description	273
4.22.2	Arguments	273
4.22.2.1	Input	273
4.22.2.2	Output	274
4.22.3	Examples	274
4.22.3.1	Structured Text	274
4.23	SerializeOut	275
4.23.1	Description	275
4.23.2	Arguments	275
4.23.2.1	Input	275
4.23.2.2	Output	276
4.23.3	Examples	276
4.23.3.1	Structured Text	276
4.24	SigID	277
4.24.1	Inputs	277
4.24.2	Outputs	277
4.24.3	Remarks	277
4.24.4	ST Language	277
4.24.5	FBD Language	277
4.24.6	FFLD Language	277
4.24.7	IL Language	277
4.25	SigPlay	278
4.25.1	Inputs	278
4.25.2	Outputs	278
4.25.3	Remarks	278
4.25.4	ST Language	278
4.25.5	FBD Language	278
4.25.6	FFLD Language	278
4.25.7	IL Language	278
4.26	SigScale	280
4.26.1	Inputs	280
4.26.2	Outputs	280
4.26.3	Remarks	280
4.26.4	ST Language	280
4.26.5	FBD Language	280
4.26.6	FFLD Language	280
4.26.7	IL Language	280
4.27	STACKINT	281
4.27.1	Inputs	281

4.27.2 Outputs	281
4.27.3 Remarks	281
4.27.4 ST Language	281
4.27.5 FBD Language	281
4.27.6 FFLD Language	281
4.27.7 IL Language	281
4.28 SurfLin	283
4.28.1 Inputs	283
4.28.2 Outputs	283
4.28.3 Remarks	283
4.29 VLID	284
4.29.1 Inputs	284
4.29.2 Outputs	284
4.29.3 Remarks	284
4.29.4 ST Language	284
4.29.5 FBD Language	284
4.29.6 FFLD Language	284
4.29.7 IL Language	284

2 Programming Languages

This chapter presents details on the syntax, structure and use of the declarations and statements supported by the KAS IDE application language.

Below are the available programming languages of the IEC 61131-3 standard:

- [Sequential Function Chart \(SFC\)](#)
- [Function Block Diagram \(FBD\)](#)
- [Free Form Ladder Diagram \(FFLD\)](#)
- [Structured Text \(ST\)](#)
- [Instruction List \(IL\)](#)

You have to select a language for each program or User-Defined Function Block of the application.

NOTE

Replace with note text When using FFLD or FBD languages, be sure to review Use of ST expressions in graphic language.

2.1 Sequential Function Chart (SFC)

The SFC language is a state diagram. Graphical steps are used to represent stable states, and transitions describe the conditions and events that lead to a change of state. Using SFC highly simplifies the programming of sequential operations as it saves a lot of variables and tests just for maintaining the program context.

⚠ IMPORTANT

You must not use SFC as a decision diagram. Using a step as a point of decision and transitions as conditions in an algorithm must never appear in an SFC chart. Using SFC as a decision language leads to poor performance and complicate charts. ST must be preferred when programming a decision algorithm that has no sense in term of "program state".

Below are basic components of an SFC chart:

Chart	Programming
Steps and initial steps	Actions within a step
Transitions and divergences	Timeout on a step
Parallel branches	Programming a transition condition
Macro-steps	
Jump to a step	How SFC is executed

The KAS IDE fully supports SFC programming with several hierarchical levels of charts: i.e. a chart that controls another chart. Working with a hierarchy of SFC charts is an easy and powerful way for managing complex sequences and saves performances at runtime. Refer to the following sections for further details:

- [Hierarchy of SFC programs](#)
- [Controlling a SFC child program](#)

2.1.1 SFC Execution at Runtime

SFC programs are executed sequentially within a target cycle, according to the order defined when entering programs in the hierarchy tree. A parent SFC program is executed before its children. This implies that when a parent starts or stops a child, the corresponding actions in the child program are performed during the same cycle.

Within a chart, all valid transitions are evaluated first, and then actions of active steps are performed. The chart is evaluated from the left to the right and from the top to the bottom. Below is an example:

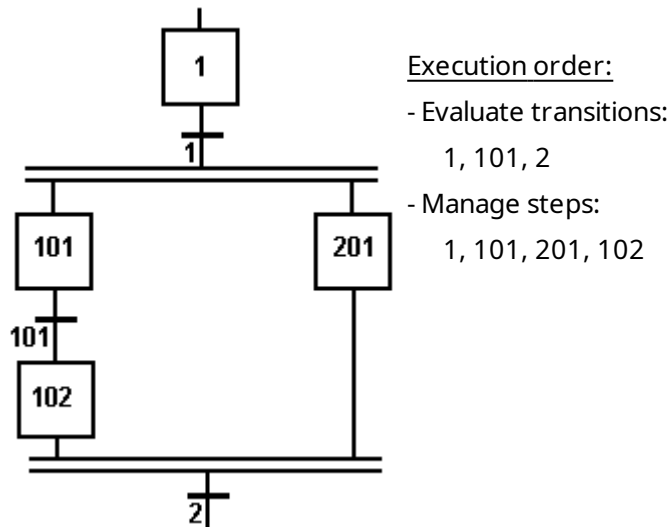

In case of a divergence, all conditions are considered as exclusive, according to a "left to right" priority order. It means that a transition is considered as FALSE if at least one of the transitions connected to the same divergence on its left side is TRUE.

The initial steps define the initial status of the program when it is started. All top level (main) programs are started when the application starts. Child programs are explicitly started from action blocks within the parent programs.

The evaluation of transitions leads to changes of active steps, according to the following rules:

- A transition is crossed if:
 - its condition is TRUE
 - and if all steps linked to the top of the transition (before) are active
- When a transition is crossed:
 - all steps linked to the top of the transition (before) are deactivated
 - all steps linked to the bottom of the transition (after) are activated

ⓘ IMPORTANT

Execution of SFC within the IEC 61131 target is sampled according to the target cycles. When a transition is crossed within a cycle, the following steps are activated, and the evaluation of the chart will continue on the next cycle. If several consecutive transitions are TRUE within a branch, only one of them is crossed within one target cycle.

ⓘ IMPORTANT

Some run-time systems can support exclusivity of the transitions within a divergence or not. Please refer to OEM instructions for further information about SFC support.

2.1.2 Hierarchy of SFC programs

Each SFC program can have one or more "child programs". Child programs are written in SFC and are started (launched) or stopped (killed) in the actions of the father program. A child program can also have children. The number of hierarchy levels must not exceed 19.

When a child program is stopped, its children are also implicitly stopped.

When a child program is started, it must explicitly in its actions start its children.

A child program is controlled (started or stopped) from the action blocks of its parent program. Designing a child program is a simple way to program an action block in SFC language.

Using child programs is very useful for designing a complex process and separate operations due to different aspects of the process. For instance, it is common to manage the execution modes in a parent program and to handle details of the process operations in child programs.

2.1.3 Controlling a SFC child program

Controlling a child program can be simply achieved by specifying the name of the child program as an action block in a step of its parent program. Below are possible qualifiers that can be applied to an action block for handling a child program:

Child (N);	Starts the child program when the step is activated and stops (kills) it when the step is deactivated.
Child (S);	Starts the child program when the step is activated (Initial steps of the child program are activated)
Child (R);	Stops (kills) the child program when the step is activated (All active steps of the child program are deactivated)

Alternatively, you can use the following statements in an action block programmed in ST language. In the following table, "prog" represents the name of the child program:

GSTART (prog);	Starts the child program when the step is activated (Initial steps of the child program are activated)
GKILL (prog);	Stops (kills) the child program when the step is activated (All active steps of the child program are deactivated)
GFREEZE (prog);	Suspends the execution of a child program
GRST (prog);	Restarts a program suspended by a GFREEZE command.

You can also use the "GSTATUS" function in expressions. This function returns the current state of a child SFC program:

GSTATUS (prog)	Returns the current state of a child SFC program: 0: program is inactive 1: program is active 2: program is suspended
----------------	--

NOTE

When a child program is started by its parent program, it keeps the "inactive" status until it is executed (further in the cycle). If you start a child program in an SFC chart, GSTATUS will return 1 (active) on the next cycle.

2.2 Function Block Diagram (FBD)

A function block Diagram is a data flow between constant expressions or variables and operations represented by rectangular blocks. Operations can be basic operations, function calls, or function block calls.

Use of ST instructions in graphic languages

The name of the operation or function, or the type of function block is written within the block rectangle. In case of a function block call, the name of the called instance is written in the header of the block rectangle, such as in the example below:



2.2.1 Data flow

The data flow represents values of any data type. All connections must be from input and outputs points having the same data type.

In case of a Boolean connection, you can use a connection link terminated by a small circle, that indicates a Boolean **negation** of the data flow. .

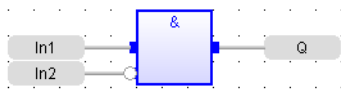

The data flow must be understood from the left to the right and from the top to the bottom. It is possible to use labels and jumps to change the default data flow execution.

2.2.2 FFLD symbols

FFLD symbols can also be entered in FBD diagrams and linked to FBD objects. Refer to the following sections for further information about components of the FFLD language:

[Contacts](#)

[Coils](#)

Power Rails

Special vertical lines are available in FBD language for representing the merging of FFLD parallel lines. Such vertical lines represent a OR operation between the connected inputs. Below is an example of an OR vertical line used in a FBD diagram:

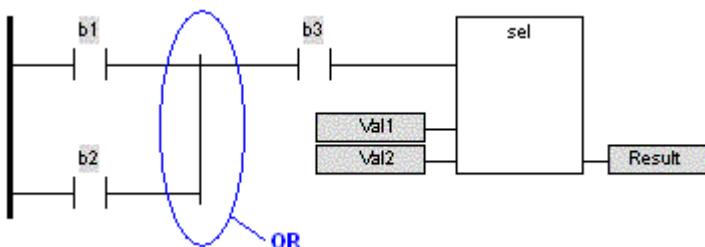

2.3 Instruction List (IL)

This language is more appropriate when your algorithm refers to the Boolean algebra.

A program written in IL language is a list of *instructions*.

- Each instruction is written on one line of text.
- An instruction can have one or more *operands*.
- Operands are variables or constant expressions.
- Each instruction can begin with a label, followed by the ":" character.
- Labels are used as destination for jump instructions.

The KAS IDE allows you to mix ST and IL languages in textual program. ST is the default language. When you enter IL instructions, the program must be entered between "BEGIN_IL" and "END_IL" keywords, such as in the following example

```
BEGIN_IL
FFLD  var1
ST    var2
END_IL
```

2.3.1 Comments

Comment texts can be entered at the end of a line containing an instruction. Comment texts have no meaning for the execution of the program. A comment text must begin with "(*" and end with "*)". Comments can also be entered on empty lines (with no instruction), and on several lines (i.e. a comment text can include line breaks). Comment texts cannot be nested.

```
(* My comment *)
LD a
ST b    (* Store value in d *)
```

2.3.2 Data flow

An IL complete statement is made of instructions for:

- first: evaluating an expression (called *current result*)
- then: use the current result for performing actions

2.3.3 Evaluation of expressions

The order of instructions in the program is the one used for evaluating expressions, unless parentheses are inserted. Below are the available instructions for evaluation of expressions:

Instruction	Operand	Meaning
FFLD / FFLDN	any type	loads the operand in the current result
AND (&)	Boolean	AND between the operand and the current result
OR / ORN	Boolean	OR between the operand and the current result
XOR / XORN	Boolean	XOR between the operand and the current result
ADD	numerical	adds the operand and the current result
SUB	numerical	subtract the operand from the current result
MUL	numerical	multiply the operand and the current result
DIV	numerical	divide the current result by the operand
GT	numerical	compares the current result with the operand
GE	numerical	compares the current result with the operand
LT	numerical	compares the current result with the operand
LE	numerical	compares the current result with the operand
EQ	numerical	compares the current result with the operand
NE	numerical	compares the current result with the operand
Function call	func. arguments	calls a function
Parenthesis		changes the execution order

NOTE

Instructions suffixed by **N** uses the Boolean negation of the operand.

2.3.4 Actions

The following instructions perform actions according to the value of current result. Some of these instructions do not need a current result to be evaluated:

Instruction	Operand	Meaning
ST / STN	any type	stores the current result in the operand
JMP	label	jump to a label - no current result needed
JMPC	label	jump to a label if the current result is TRUE
JMPNC / JMPCN	label	jump to a label if the current result is FALSE
RET		Jump to the end of the current program - no current result needed
RETC / RETNC / RETCN		Jump to the end of the current program if the current result is TRUE / FALSE
S	Boolean	sets the operand to TRUE if the current result is TRUE
R	Boolean	sets the operand to FALSE if the current result is TRUE
CAL	f. block	calls a function block (no current result needed)
CALC	f. block	calls a function block if the current result is TRUE
CALNC / CALCN	f. block	calls a function block if the current result is FALSE

NOTE

Instructions suffixed by **N** uses the Boolean negation of the operand.

NOTE

IL program cannot be called if there is no entry variable, or if its type is complex (e.g. array)

2.4 Structured Text (ST)

ST is a structured literal programming language. A ST program is a list of *statements*. Each statement describes an action and must end with a semi-colon (";").

The presentation of the text has no meaning for a ST program. You can insert blank characters and line breaks where you want in the program text.

2.4.1 Comments

Comment texts can be entered anywhere in a ST program. Comment texts have no meaning for the execution of the program. A comment text must begin with "(*" and end with "*)". Comments can be entered on several lines (i.e. a comment text can include line breaks). Comment texts cannot be nested.

You can also use `//` to add a comment on a single line as shown below:

```
//My main comment
(* My comment *)
a := d + e;
(* A comment can also
be on several lines *)
b := d * e;

c := d - e; (* My comment *)
```

2.4.2 Expressions

Each statement describes an action and can include evaluation of complex expressions. An expression is evaluated:

- from the left to the right
- according to the default priority order of operators
- the default priority can be changed using parentheses

Arguments of an expression can be:

- declared variables
- constant expressions
- function calls

2.4.3 Statements

Below are available basic statements that can be entered in a ST program:

- [assignment](#)
- function block calling

Below are the available conditional statements in ST language:

- [IF / THEN / ELSE](#)

Simple binary switch.

One or several ELSIF are allowed.

```
IF a = b THEN
    c := 0;
```



```

ELSIF a < b THEN
    c := 1;
ELSE
    c := -1;
END_IF;

```

- CASE

Switch between enumerated statements according to an expression. The selector can be any integer or a STRING.

```

CASE iChoice OF
0:
MyString := 'Nothing';
1 .. 2,5:
MyString := 'First case';
3,4:
MyString := 'Second case';
ELSE
MyString := 'Other case';
END_CASE;

```

Below are the available statements for describing loops in ST language:

ⓘ IMPORTANT

Loop instructions can lead to infinite loops that block the target cycle. Never test the state of an input in the condition as the input will not be refreshed before the next cycle.

- WHILE

Repeat a list of statements. Condition is evaluated on loop **entry** before the statements.

```

iCount := 0;
WHILE iCount < 100 DO
iCount := iCount +1;
MyVar := MyVar + 1;
END_WHILE;

```

- REPEAT

Repeat a list of statements. Condition is evaluated on loop **exit** after the statements.

```

iCount := 0;
REPEAT

```

```
MyVar := MyVar + 1;  
iCount := iCount + 1;  
UNTIL iCount < 100 END_REPEAT;
```

- FOR

Iteration of statement execution.

The **BY** statement is optional (default value is 1)

```
FOR iCount := 0 TO 100 BY 2 DO  
MyVar := MyVar + 1;  
END_FOR;
```

NOTE

Loops with FOR instructions are slow, so you can optimize your code by replacing such iterations with a WHILE statement.

Below are some other statements in ST language:

- **WAIT / WAIT_TIME** (suspend the execution)

- **ON ... DO** (conditional execution of statements: provides a simpler syntax for checking the rising edge of a Boolean condition)

TIP

ST also provides an automatic completion of typed words. See .

2.5 Free Form Ladder Diagram (FFLD)

A Ladder Diagram is a list of *rungs*. Each rung represents a Boolean data flow from a power rail on the left. The power rail represents the TRUE state. The data flow must be understood from the left to the right. Each symbol connected to the rung either changes the rung state or performs an operation. Below are possible graphic items to be entered in FFLD diagrams:

Power Rails

[Contacts and Coils](#)

Operations, Functions and Function blocks, represented by rectangular blocks

Labels and Jumps

Use of ST instructions in graphic languages

2.5.1 Use of the "EN" input and the "ENO" output for blocks

The rung state in a FFLD diagram is always Boolean. Blocks are connected to the rung with their first input and output. This implies that special "EN" and "ENO" input and output are added to the block if its first input or output is not Boolean.

The "EN" input is a condition. It means that the operation represented by the block is not performed if the rung state (EN) is FALSE. The "ENO" output always represents the same status as the "EN" input: the rung state is not modified by a block having an ENO output.

- Below is the example of the "XOR" block, having Boolean inputs and outputs, and requiring no EN or ENO pin:

```
(* First input is the rung. The rung is the output *)
```

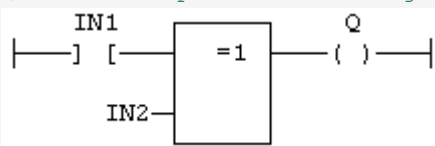

- Below is the example of the ">" (greater than) block, having non Boolean inputs and a Boolean output. This block has an "EN" input in FFLD language:

```
(* The comparison is executed only if EN is TRUE *)
```

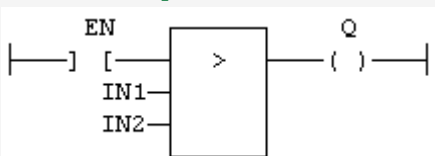

- Below is the example of the "SEL" function, having a first Boolean input, but an integer output. This block has an "ENO" output in FFLD language:

```
(* the input rung is the selector *)  
(* ENO has the same value as SELECT *)
```

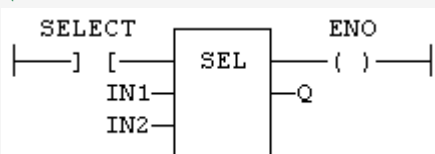

- Finally, below is the example of an addition, having only numerical arguments. This block has both "EN" and "ENO" pins in FFLD language:

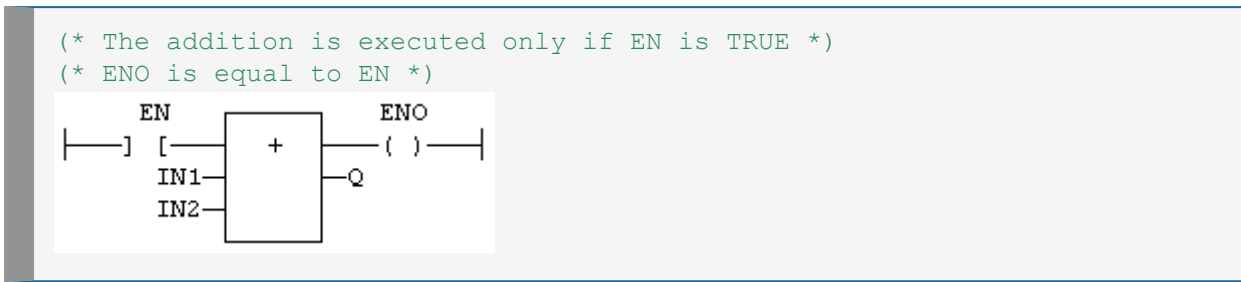

2.5.2 Contacts and coils

The table below contains a list of the contact and coil types available:

Contacts	Coils
Normally Open - -	Energize -()-
Normally Closed - / -	De-energize -(/)-
Positive Transition - P -	Set (Latch) -(S)-
Negative Transition - N -	Reset (Unlatch) -(R)-
Normally closed positive transition - /P -	Positive transition sensing coil -(P)-
Normally closed negative transition - /N -	Negative transition sensing coil -(N)-

2.5.2.1 FFLD Contacts

Contacts are basic graphic elements of the FFLD language. A contact is associated with a Boolean variable which is displayed above the graphic symbol. A contact sets the state of the rung on its right-hand side, according to the value of the associated variable and the rung state on its left-hand side.

Below are the six possible contact symbols and how they change the flow:

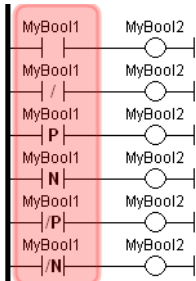

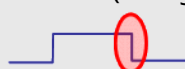
Contacts	Description
boolVariable -] [-	Normal: The flow on the right is the Boolean AND operation between: (1) the flow on the left and (2) the associated variable.
boolVariable -]/ [-	Negated: The flow on the right is the Boolean AND operation between: (1) the flow on the left and (2) the negation of the associated variable.
boolVariable -]P[-	Positive Transition: The flow on the right is TRUE when the flow on the left is TRUE and the associated variable is TRUE and was FALSE the last time this contact was scanned (rising edge). 
boolVariable -]N[-	Negative Transition: The flow on the right is TRUE when the flow on the left is TRUE and the associated variable is FALSE and was TRUE last time this contact was scanned (falling edge). 
boolVariable -]/P[-	Normally Closed Positive Transition: The flow on the right is TRUE when the flow on the left is TRUE and the associated variable does not change from FALSE to TRUE from the last scan of this contact to this scan (NOT rising edge).
boolVariable -]/N[-	Normally Closed Negative Transition: The flow on the right is TRUE when the flow on the left is TRUE and the associated variable does not change from TRUE to FALSE from the last scan of this contact to this scan (NOT falling edge).

Serialized and Parallel contacts

Two serial normal contacts represent an AND operation.

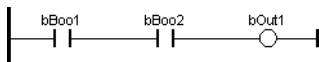

Two contacts in parallel represent an OR operation.

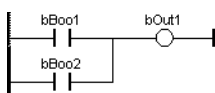

Transition Contacts

The transition contacts -|P|-, -|N -|/P|-, and -|/N| compare the current state of the Boolean variable to the Boolean's state the last time the contact was scanned. This means that the Boolean variable could change states several times during a scan, but if it's back to the same state when the transition

contact is scanned, the transition contact will not produce a TRUE. Also, some function blocks can complete immediately. Therefore a different approach, other than using transition contacts, is needed to determine if a function block completed successfully.

For example:

MC_GrpEnable executes and turns on its Done output immediately. In the following code, the GroupEnableDone positive transition contact will only provide a TRUE the first time MC_GrpEnable is executed. For all subsequent executions, the positive transition contact will not provide a TRUE since GroupEnableDone will be TRUE every time the contact is scanned.

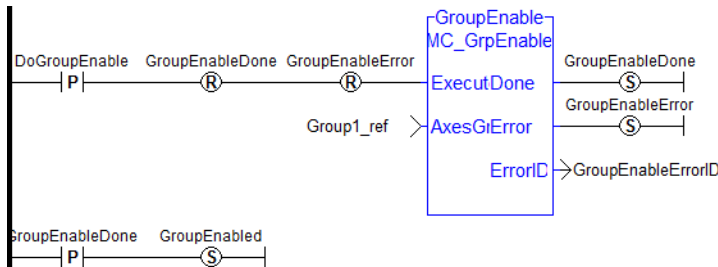

To remedy this, the following code uses the SET and RESET of a Boolean (i.e. EnableRequest) to provide a way to detect each successful execution of the function block:

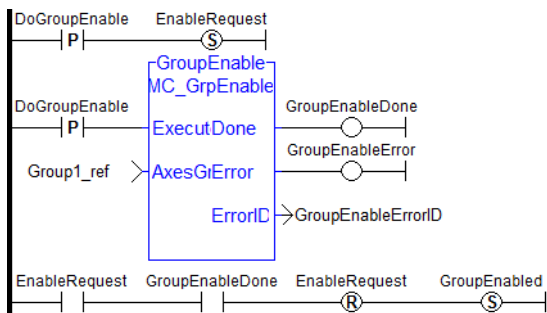

TIP

When a contact or coil is selected, you can press the **Spacebar** to change its type (normal, negated...).

When your application is running, you can select a contact and press the **Spacebar** to swap its value between TRUE and FALSE.

2.5.2.2 FFLD Coils

Coils are basic graphic elements of the FFLD language. A coil is associated with a Boolean variable which is displayed above the graphic symbol. A coil performs a change of the associated variable according to the flow on its left-hand side.

Below are the six possible coil symbols:

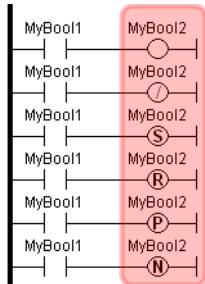

Coils	Description
boolVariable - () -	Normal: the associated variable is forced to the value of the flow on the left of the coil.
boolVariable - (/) -	Negated: the associated variable is forced to the negation of the flow on the left of the coil.
boolVariable - (S) -	<p>Set: the associated variable is forced to TRUE if the flow on the left is TRUE. (no action if the flow is FALSE)</p> <p>Rules for Set coil animation:</p> <ul style="list-style-type: none"> • Power Flow on left is TRUE: <ul style="list-style-type: none"> • The horizontal wires on either side of the (S) are red • The variable and the (S) are red • Power Flow on left is FALSE and the (S) variable is Energized (ON) <ul style="list-style-type: none"> • The horizontal lines on either side of (S) are black • The variable and the (S) are red • In all other cases: <ul style="list-style-type: none"> • The horizontal wires are black • The variable and the (S) are black
boolVariable - (R) -	<p>Reset: the associated variable is forced to FALSE if the flow on the left is TRUE. (no action if the rung state is FALSE)</p> <p>Rules for Reset coil animation:</p> <ul style="list-style-type: none"> • Power Flow on left is TRUE: <ul style="list-style-type: none"> • The horizontal lines are red • The variable above (R) is black • The R and the circle around the R are black • Power Flow on left is FALSE and variable above reset coil is NOT Energized (OFF) <ul style="list-style-type: none"> • The horizontal lines are black • The variable above (R) is black • The R and the circle around the R are black • Power Flow on left is FALSE and variable above reset coil is Energized (ON) <ul style="list-style-type: none"> • The horizontal lines are black • The variable above (R) is red • The R and the circle around the R are red
boolVariable - (P) -	Positive transition: the associated variable is forced to TRUE if the flow on the left changes from FALSE to TRUE (and forced to FALSE in all other cases)
boolVariable - (N) -	Negative transition: the associated variable is forced to TRUE if the flow on the left changes from TRUE to FALSE (and forced to FALSE in all other cases)

 **TIP**

When a contact or coil is selected, you can press the **Spacebar** to change its type (normal, negated...).

When your application is running, you can select a contact and press the **Spacebar** to swap its value between TRUE and FALSE.

 **IMPORTANT**

Although coils are commonly put at the end, the rung can be continued after a coil. The flow is **never changed** by a coil symbol.

3 PLC Standard Libraries

The following topics detail the set of programming features and standard blocks:

- [Basic Operations](#)
- [Boolean operations](#)
- [Arithmetic operations](#)
- [Comparison Operations](#)
- [Type conversion functions](#)
- [Selectors](#)
- [Registers](#)
- [Counters](#)
- [Timers](#)
- [Mathematic operations](#)
- [Trigonometric functions](#)
- [String operations](#)
- [PLC Advanced Libraries](#)

Note: Some other functions not documented here are reserved for diagnostics and special operations. Please contact your technical support for further information.

3.1 Basic Operations

Below are the language features for basic data manipulation:

- Variable assignment
- Bit access
- Parenthesis
- Calling a function
- Calling a function block
- Calling a sub-program
- MOVEBLOCK: Copying/moving array items
- COUNTOF: Number of items in an array
- INC: Increase a variable
- DEC: decrease a variable
- NEG: integer negation (unary operator)

Below are the language features for controlling the execution of a program:

- Labels
- Jumps
- RETURN

Below are the structured statements for controlling the execution of a program:

IF	Conditional execution of statements.
WHILE	Repeat statements while a condition is TRUE.
REPEAT	Repeat statements until a condition is TRUE.
FOR	Execute iterations of statements.
CASE	Switch to one of various possible statements.
EXIT	Exit from a loop instruction.
WAIT	Delay program execution.
ON	Conditional execution.

3.1.1 := PLCopen 

Operator - variable assignment.

3.1.1.1 Inputs

IN : ANY Any variable or complex expression

3.1.1.2 Outputs

Q : ANY Forced variable

3.1.1.3 Remarks

The output variable and the input expression must have the same type. The forced variable cannot have the "read only" attribute. In FFLD and FBD languages, the "1" block is available to perform a "1 gain" data copy (1 copy). In FFLD language, the input rung (EN) enables the assignment, and the output rung keeps the state of the input rung. In IL language, the FFLD instruction loads the first operand, and the ST instruction stores the current result into a variable. The current result and the operand of ST must have the same type. Both FFLD and ST instructions can be modified by "N" in case of a Boolean operand for performing a Boolean negation.

3.1.1.4 ST Language

Q := IN; (* copy IN into variable Q *)

Q := (IN1 + (IN2 / IN 3)) * IN4; (* assign the result of a complex expression *)

result := SIN (angle); (* assign a variable with the result of a function *)

time := MyTon.ET; (* assign a variable with an output parameter of a function block *)

3.1.1.5 FBD Language**3.1.1.6 FFLD Language**

(* The copy is executed only if EN is TRUE *)

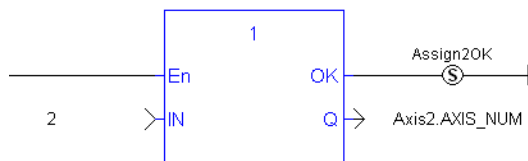
**3.1.1.7 IL Language:**

Op1: FFLD IN (* current result is: IN *)

ST Q (* Q is: IN *)

FFLDN IN1 (* current result is: NOT (IN1) *)

ST Q (* Q is: NOT (IN1) *)

FFLD IN2 (* current result is: IN2 *)

STN Q (* Q is: NOT (IN2) *)

See also:

[Parenthesis](#)

3.1.2 Access to Bits of an Integer

You can directly specify a bit within an integer variable in expressions and diagrams, using the following notation:

Variable.BitNo

Where:

Variable: is the name of an integer variable

BitNo: is the number of the bit in the integer.

The variable can have one of the following data types:

SINT, USINT, BYTE (8 bits from .0 to .7)

INT, UINT, WORD (16 bits from .0 to .15)



DINT, UDINT, DWORD (32 bits from .0 to 31)

64-bit variables are not supported. The following variable types cannot use bit access: LINT, ULINT, LWORD

0 always represents the less significant bit.

3.1.3 Differences Between Functions and Function Blocks

It is important to clearly understand what is different between functions and function blocks.

- A Function¹ () is called once and it performs an action. This is synchronous.
- A Function Block² () or "FB" is an instance that has its own set of data. A FB very likely maintains its own, internal machine state and very often has an output to indicate when the work is done. A FB is most likely to be asynchronous.

The best way to work with a function block is to call it during multiple scan. This triggers the action the first time, then you may monitor the status of this action, especially via the "done" output.

3.1.4 Calling a Sub-Program

A sub-program is called by another program. Unlike function blocks, local variables of a sub-program are not instantiated, and thus you do not need to declare instances. A call to a sub-program processes the block algorithm using the specified input parameters. Output parameters can then be accessed.

3.1.4.1 ST Language

To call a sub-program in ST, you have to specify its name, followed by the input parameters written between parentheses and separated by commas. To have access to an output parameter, use the name of the sub-program followed by a dot '.' and the name of the wished parameter:

```
MySubProg (i1, i2); (* calls the sub-program *)
Res1 := MySubProg.Q1;
Res2 := MySubProg.Q2;
```

Alternatively, if a sub-program has one and only one output parameter, it can be called as a function in ST language:

¹A function calculates a result according to the current value of its inputs. A function has no internal data and is not linked to declared instances.

²A function block groups an algorithm and a set of private data. It has inputs and outputs.

```
Res := MySubProg (i1, i2);
```

3.1.4.2 FBD and FFLD Languages

To call a sub-program in FBD or FFLD languages, you just need to insert the block in the diagram and to connect its inputs and outputs.

3.1.4.3 IL Language

To call a sub-program in IL language, you must use the CAL instruction with the name of the sub-program, followed by the input parameters written between parentheses and separated by commas. Alternatively the CALC, CALCN or CALNC conditional instructions can be used:

```
CAL    Calls the sub-program
CALC   Calls the sub-program if the current result is TRUE
CALNC  Calls the sub-program if the current result is FALSE
CALCN  same as CALNC
```

Here is an example:

```
Op1: CAL  MySubProg (i1, i2)
FFLD  MySubProg.Q1
ST  Res1
FFLD  MySubProg.Q2
ST  Res2
```

3.1.5 CASE OF ELSE END_CASE

Statement - switch between enumerated statements.

3.1.5.1 Syntax

```
CASE <DINT expression> OF
<value> :
    <statements>
<value> , <value> :
    <statements>;
<value> .. <value> :
    <statements>;
ELSE
    <statements>
END_CASE;
```

3.1.5.2 Remarks

All enumerated values correspond to the evaluation of the DINT expression and are possible cases in the execution of the statements. The statements specified after the ELSE keyword are executed if the expression takes a value which is not enumerated in the switch. For each case, you must specify either a value, or a list of possible values separated by commas (",") or a range of values specified by a "min .. max" interval. You must enter space characters before and after the ".." separator.

3.1.5.3 ST Language

(* this example check first prime numbers *)

```
CASE iNumber OF
0 :
    Alarm := TRUE;
    AlarmText := '0 gives no result';
1 .. 3, 5 :
    bPrime := TRUE;
4, 6 :
    bPrime := FALSE;
ELSE
    Alarm := TRUE;
    AlarmText := 'I don't know after 6 !';
END_CASE;
```

3.1.5.4 FBD Language

Not available

3.1.5.5 FFLD Language

Not available

3.1.5.6 IL Language

Not available

See also

[IF WHILE REPEAT FOR EXIT](#)

3.1.6 COUNTOF PLCopen

Function - Returns the number of items in an array

3.1.6.1 Inputs

ARR : ANY Declared array

3.1.6.2 Outputs

Q : DINT Total number of items in the array

3.1.6.3 Remarks

The input must be an array and can have any data type. This function is particularly useful to avoid writing directly the actual size of an array in a program, and thus keep the program independent from the declaration. Example:

```
FOR i := 1 TO CountOf (MyArray) DO
  MyArray[i-1] := 0;
END_FOR;
```

In FLD language, the operation is executed only if the input rung (EN) is TRUE. The output rung (ENO) keeps the same value as the input rung.

Examples

array	return
Arr1 [0..9]	10
Arr2 [0..4, 0..9]	50

3.1.6.4 ST Language

Q := CountOf (ARR);

3.1.6.5 FBD Language



3.1.6.6 FFLD Language

(* The function is executed only if EN is TRUE *)
 (* ENO keeps the same value as EN *)

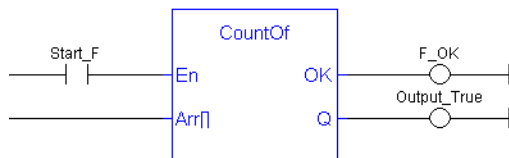

3.1.6.7 IL Language

Not available

3.1.7 DEC PLCopen

Function - Decrease a numerical variable

3.1.7.1 Inputs

IN : ANY Numerical variable (increased after call).

3.1.7.2 Outputs

Q : ANY Decreased value

3.1.7.3 Remarks

When the function is called, the variable connected to the "IN" input is decreased and copied to Q. All data types are supported except BOOL and STRING: for these types, the output is the copy of IN.

For real values, variable is decreased by "1.0". For time values, variable is decreased by 1 ms.

The IN input must be directly connected to a variable, and cannot be a constant or complex expression.

This function is particularly designed for ST language. It allows simplified writing as assigning the result of the function is not mandatory.

3.1.7.4 ST Language

```
IN := 2;
Q := DEC (IN);
(* now: IN = 1 ; Q = 1 *)
```

```
DEC (IN); (* simplified call *)
```

3.1.7.5 FBD Language



3.1.7.6 FFLD Language

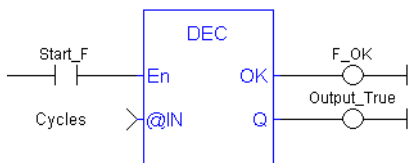

3.1.7.7 IL Language

not available

3.1.8 EXIT

Statement - Exit from a loop statement

3.1.8.1 Remarks

The EXIT statement indicates that the current loop (WHILE, REPEAT or FOR) must be finished. The execution continues after the END_WHILE, END_REPEAT or END_FOR keyword or the loop where the EXIT is. EXIT quits only one loop and cannot be used to exit at the same time several levels of nested loops.

! IMPORTANT

loop instructions can lead to infinite loops that block the target cycle.

3.1.8.2 ST Language

```
(* this program searches for the first non null item of an array *)
iFound = -1; (* means: not found *)
FOR iPos := 0 TO (iArrayDim - 1) DO
  IF iPos <> 0 THEN
    iFound := iPos;
    EXIT;
  END_IF;
END_FOR;
```

3.1.8.3 FBD Language

Not available

3.1.8.4 FFLD Language

Not available

3.1.8.5 IL Language

Not available

See also

[IF WHILE REPEAT FOR CASE](#)

3.1.9 FOR TO BY END_FOR

Statement - Iteration of statement execution.

3.1.9.1 Syntax

```
FOR <index> := <minimum> TO <maximum> BY <step> DO
  <statements>
END_FOR;
```

index = DINT internal variable used as index

minimum = DINT expression: initial value for *index*

maximum = DINT expression: maximum allowed value for *index*

step = DINT expression: increasing step of *index* after each iteration (default is 1)

3.1.9.2 Remarks

The "BY <step>" statement can be omitted. The default value for the step is 1.

3.1.9.3 ST Language

```
iArrayDim := 10;

(* resets all items of the array to 0 *)
FOR iPos := 0 TO (iArrayDim - 1) DO
  MyArray[iPos] := 0;
END_FOR;

(* set all items with odd index to 1 *)
FOR iPos := 1 TO 9 BY 2 DO
  MyArray[iPos] := 1;
END_FOR;
```

3.1.9.4 FBD Language

Not available

3.1.9.5 FFLD Language

Not available

3.1.9.6 IL Language

Not available

See also

[IF WHILE REPEAT CASE EXIT](#)

3.1.10 IF THEN ELSE ELSIF END_IF

Statement - Conditional execution of statements.

3.1.10.1 Syntax

```
IF <BOOL expression> THEN
<statements>
ELSIF <BOOL expression> THEN
<statements>
ELSE
<statements>
END_IF;
```

3.1.10.2 Remarks

The IF statement is available in ST only. The execution of the statements is conditioned by a Boolean expression. ELSIF and ELSE statements are optional. There can be several ELSIF statements.

3.1.10.3 ST Language

```
(* simple condition *)

IF bCond THEN
  Q1 := IN1;
  Q2 := TRUE;
END_IF;

(* binary selection *)
IF bCond THEN
  Q1 := IN1;
  Q2 := TRUE;
ELSE
  Q1 := IN2;
  Q2 := FALSE;
END_IF;

(* enumerated conditions *)
IF bCond1 THEN
  Q1 := IN1;
ELSIF bCond2 THEN
  Q1 := IN2;
ELSIF bCond3 THEN
  Q1 := IN3;
ELSE
  Q1 := IN4;
END_IF;
```

3.1.10.4 FBD Language

Not available

3.1.10.5 FFLD Language

Not available

3.1.10.6 IL Language

Not available

See also

[WHILE REPEAT FOR CASE EXIT](#)

3.1.11 INC PLCopen

Function - Increase a numerical variable

3.1.11.1 Inputs

IN : ANY Numerical variable (increased after call).

3.1.11.2 Outputs

Q : ANY Increased value

3.1.11.3 Remarks

When the function is called, the variable connected to the "IN" input is increased and copied to Q. All data types are supported except BOOL and STRING: for these types, the output is the copy of IN.

For real values, variable is increased by "1.0". For time values, variable is increased by 1 ms.

The IN input must be directly connected to a variable, and cannot be a constant or complex expression.

This function is particularly designed for ST language. It allows simplified writing as assigning the result of the function is not mandatory.

3.1.11.4 ST Language

```
IN := 1;
Q := INC (IN);
(* now: IN = 2 ; Q = 2 *)
```

```
INC (IN); (* simplified call *)
```

3.1.11.5 FBD Language



3.1.11.6 FFLD Language

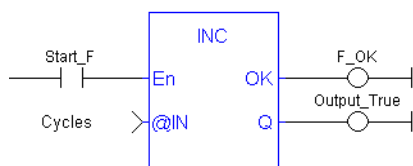

3.1.11.7 IL Language

not available

3.1.12 MOVEBLOCK PLCopen

Function - Move/Copy items of an array.

3.1.12.1 Inputs

SRC: ANY (*)	Array containing the source of the copy
DST : ANY (*)	Array containing the destination of the copy
PosSRC: DINT	Index of the first character in SRC
PosDST : DINT	Index of the destination in DST
NB : DINT	Number of items to be copied

(*) SRC and DST cannot be a STRING

3.1.12.2 Outputs

OK : BOOL	TRUE if successful
-----------	--------------------

3.1.12.3 Remarks

Arrays of string are not supported by this function.

In FFLD language, the operation is executed only if the input rung (EN) is TRUE. The function is not available in IL language.

The function copies a number (NB) of consecutive items starting at the PosSRC index in SRC array to PosDST position in DST array. SRC and DST can be the same array. In that case, the function avoids lost items when source and destination areas overlap.

This function checks array bounds and is always safe. The function returns TRUE if successful. It returns FALSE if input positions and number do not fit the bounds of SRC and DST arrays.

3.1.12.4 ST Language

```
OK := MOVEBLOCK (SRC, DST, PosSRS, PosDST, NB);
```

3.1.12.5 FBD Language

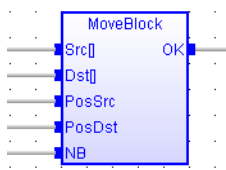

3.1.12.6 FFLD Language

(* The function is executed only if EN is TRUE *)

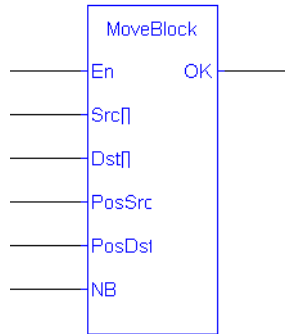

3.1.12.7 IL Language

Not available

3.1.13 NEG - PLCopen

Operator - Performs an integer negation of the input.

3.1.13.1 Inputs

IN : DINT Integer value

3.1.13.2 Outputs

Q : DINT Integer negation of the input

3.1.13.3 Truth table (examples)

IN	Q
0	0
1	-1
-123	123

3.1.13.4 Remarks

- In FBD and FFLD language, the block "NEG" can be used.
- In FFLD language, the operation is executed only if the input rung (EN) is TRUE. The output rung (ENO) keeps the same value as the input rung.
- This feature is not available in IL language. In ST language, "-" can be followed by a complex Boolean expression between parentheses.

3.1.13.5 ST Language

```
Q := -IN;
Q := - (IN1 + IN2);
```

3.1.13.6 FBD Language



3.1.13.7 FFLD Language

(* The negation is executed only if EN is TRUE *)

(* ENO keeps the same value as EN *)

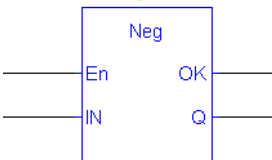

3.1.14 ON

Statement - Conditional execution of statements.

The ON instruction provides a simpler syntax for checking the rising edge of a Boolean condition.

3.1.14.1 Syntax

```
ON <BOOL expression> DO
  <statements>
END_DO;
```

3.1.14.2 Remarks

Statements within the ON structure are executed only when the Boolean expression rises from FALSE to TRUE. The ON instruction avoids systematic use of the R_TRIG function block or other "last state" flags.

The ON syntax is available in any program, sub-program or UDFB.

This statement is an extension to the standard and is not IEC61131-3 compliant.

! IMPORTANT

This instruction **should not be used inside UDFBs**. This instruction is not UDFB safe.

3.1.14.3 ST Language

```
(* This example counts the rising edges of variable bIN *)
ON bIN DO
  diCount := diCount + 1;
END_DO;
```

3.1.15 ()

Operator - force the evaluation order in a complex expression.

3.1.15.1 Remarks

Parentheses are used in ST and IL language for changing the default evaluation order of various operations within a complex expression. For instance, the default evaluation of "2 * 3 + 4" expression in ST language gives a result of 10 as "*" operator has highest priority. Changing the expression as "2 * (3 + 4)" gives a result of 14. Parentheses can be nested in a complex expression.

Below is the default evaluation order for ST language operations (1rst is highest priority):

Unary operators	- NOT
Multiply/Divide	* /
Add/Subtract	+ -
Comparisons	< > <= >= = <>
Boolean And	& AND
Boolean Or	OR
Exclusive OR	XOR

In IL language, the default order is the sequence of instructions. Each new instruction modifies the current result sequentially. In IL language, the opening parenthesis "(" is written between the instruction and its operand. The closing parenthesis ")" must be written alone as an instruction without operand.

3.1.15.2 ST Language

```
Q := (IN1 + (IN2 / IN 3)) * IN4;
```

3.1.15.3 FBD Language

Not available

3.1.15.4 FFLD Language

Not available

3.1.15.5 IL Language

```
Op1: FFLD( IN1
  ADD( IN2
    MUL IN3
  )
  SUB IN4
)
ST Q (* Q is: (IN1 + (IN2 * IN3) - IN4) *)
```

See also

[Assignment](#)

3.1.16 REPEAT UNTIL END_REPEAT

Statement - Repeat a list of statements.

3.1.16.1 Syntax

```
REPEAT
  <statements>
UNTIL <BOOL expression> END_REPEAT;
```

3.1.16.2 Remarks

The statements between "REPEAT" and "UNTIL" are executed until the Boolean expression is TRUE. The condition is evaluated **after** the statements are executed. Statements are executed at least once.

⚠ IMPORTANT

Loop instructions can lead to infinite loops that block the target cycle. Never test the state of an input in the condition as the input will not be refreshed before the next cycle.

3.1.16.3 ST Language

```
iPos := 0;
REPEAT
  MyArray[iPos] := 0;
  iNbCleared := iNbCleared + 1;
  iPos := iPos + 1;
UNTIL iPos = iMax END_REPEAT;
```

3.1.16.4 FBD Language

Not available

3.1.16.5 FFLD Language

Not available

3.1.16.6 IL Language

Not available

See also

[IF WHILE FOR CASE EXIT](#)

3.1.17 RETURN RET RETC RETNC RETCN

Statement - Jump to the end of the program.

3.1.17.1 Remarks

The "RETURN" statement jumps to the end of the program. In FBD language, the return statement is represented by the "<RETURN>" symbol. The input of the symbol must be connected to a valid Boolean signal. The jump is performed only if the input is TRUE. In FLD language, the "<RETURN>" symbol is used as a coil at the end of a rung. The jump is performed only if the rung state is TRUE. In IL language, RET, RETC, RETCN and RETNC instructions are used.

When used within an action block of an SFC step, the RETURN statement jumps to the end of the action block.

3.1.17.2 ST Language

```
IF NOT bEnable THEN
    RETURN;
END_IF;
(* the rest of the program will not be executed if bEnable is FALSE *)
```

3.1.17.3 FBD Language

(* In this example the DTat block will not be called if bIgnore is TRUE *)

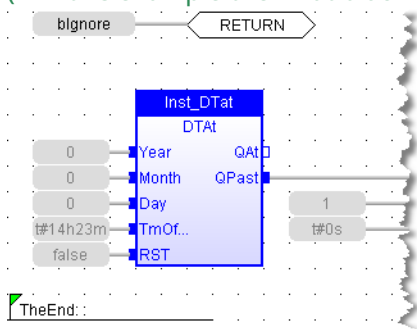

3.1.17.4 FFLD Language

(* In this example all the networks above 5 are skipped if ENABLE is FALSE *)

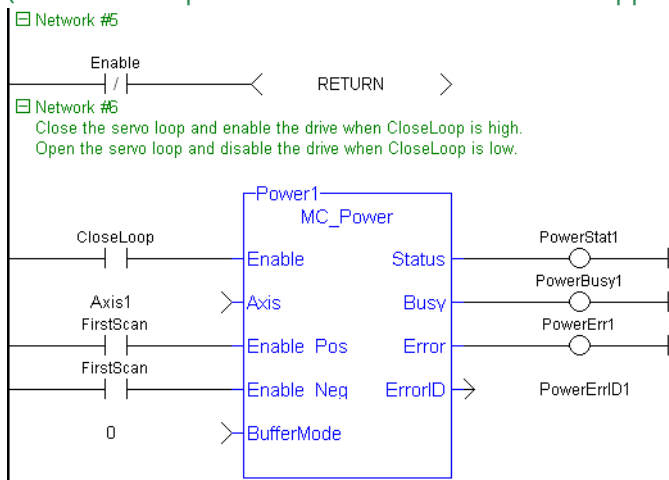

3.1.17.5 IL Language

Below is the meaning of possible instructions:

RET Jump to the end always

RETC Jump to the end if the current result is TRUE

RETNC Jump to the end if the current result is FALSE

RETCN Same as RETNC

```
Start: FFLD  IN1
       RETC          (* Jump to the end if IN1 is TRUE *)

       FFLD  IN2     (* these instructions are not executed *)
       ST    Q2      (* if IN1 is TRUE *)
       RET          (* Jump to the end unconditionally *)

       FFLD  IN3     (* these instructions are never executed *)
       ST    Q3
```

See also

Labels Jumps

3.1.18 WAIT / WAIT_TIME

Statement - Suspend the execution of a ST program.

The WAIT instruction provides an easy way to program a state machine. This avoids the use of complex CASE structures.

3.1.18.1 Syntax

```
WAIT <BOOL expression> ;
WAIT_TIME <TIME expression> ;
```

3.1.18.2 Remarks

The WAIT statement checks the attached Boolean expression and does the following:

- If the expression is TRUE, the program continues normally.
- If the expression is FALSE, then the execution of the program is suspended up to the **next PLC cycle**. The Boolean expression will be checked again during next cycles until it becomes TRUE. The execution of other programs is not affected.

The WAIT_TIME statement suspends the execution of the program for the specified duration. The execution of other programs is not affected.

These instructions are available in ST language only and has no correspondence in other languages. These instructions cannot be called in a User-Defined Function Block (UDFB). The use of WAIT or WAIT_TIME in a UDFB provokes a compile error.

WAIT and WAIT_TIME instructions can be called in a sub-program. However, it can lead to some unsafe situation if the same sub program is called from various programs. Re-entrancy is not supported by WAIT and WAIT_TIME instructions. Avoiding this situation is the responsibility of the programmer. The compiler outputs some warning messages if a sub-program containing a WAIT or WAIT_TIME instruction is called from more than one program.

These instructions must not be called from ST parts of SFC programs. This makes no sense as SFC is already a state machine. The use of WAIT or WAIT_TME in SFC or in a sub-program called from SFC provokes a compile error.

These instructions are not available when the code is compiled through a "C" compiler. Using "C" code generation with a program containing a WAIT or WAIT_TIME instruction provokes an error during post-compiling.

These statement are extensions to the standard and are not IEC61131-3 compliant.

⚠ IMPORTANT

This instruction **should not be used inside UDFBs**. This instruction is not UDFB safe.

3.1.18.3 ST Language

```
(* use of WAIT with different kinds of BOOL expressions *)
WAIT BoolVariable;
WAIT (diLevel > 100) AND NOT bAlarm;
WAIT SubProgCall ();
(* use of WAIT_TIME with different kinds of TIME expressions *)
WAIT_TIME t#2s;
WAIT_TIME TimeVariable;
```

3.1.19 WHILE DO END_WHILE

Statement - Repeat a list of statements.

3.1.19.1 Syntax

```
WHILE <BOOL expression> DO
  <statements>
END_WHILE;
```

3.1.19.2 Remarks

The statements between "DO" and "END_WHILE" are executed while the Boolean expression is TRUE. The condition is evaluated **before** the statements are executed. If the condition is FALSE when WHILE is first reached, statements are never executed.

⚠ IMPORTANT

Loop instructions can lead to infinite loops that block the target cycle. Never test the state of an input in the condition as the input will not be refreshed before the next cycle.

3.1.19.3 ST Language

```
iPos := 0;
WHILE iPos < iMax DO
  MyArray[iPos] := 0;
  iNbCleared := iNbCleared + 1;
END_WHILE;
```

3.1.19.4 FBD Language

Not available

3.1.19.5 FFLD Language

Not available

3.1.19.6 IL Language

Not available

See also

[IF REPEAT FOR CASE EXIT](#)

3.2 Boolean operations PLCopen

Below are the standard operators for managing Booleans:

AND	performs a Boolean AND
OR	performs a Boolean OR
XOR	performs an exclusive OR
NOT	performs a Boolean negation of its input
QOR	qualified OR
S	force a Boolean output to TRUE
R	force a Boolean output to FALSE

Below are the available blocks for managing Boolean signals:

RS	reset dominant bistable
SR	set dominant bistable
R_TRIG	rising pulse detection
F_TRIG	falling pulse detection
SEMA	semaphore
FLIPFLOP	flipflop^bistable

3.2.1 FLIPFLOP PLCopen ✓

Function Block - Flipflop bistable.

3.2.1.1 Inputs

IN : BOOL Swap command (on rising edge)
RST : BOOL Reset to FALSE

3.2.1.2 Outputs

Q : BOOL Output

3.2.1.3 Remarks

The output is systematically reset to FALSE if RST is TRUE.
The output changes on each rising edge of the IN input, if RST is FALSE.

3.2.1.4 ST Language

(* MyFlipFlop is declared as an instance of FLIPFLOP function block *)

MyFlipFlop (IN, RST);

Q := MyFlipFlop.Q;

3.2.1.5 FBD Language



3.2.1.6 FFLD Language

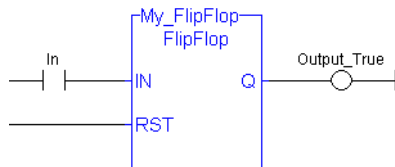

3.2.1.7 IL Language

(* MyFlipFlop is declared as an instance of FLIPFLOP function block *)

Op1: CAL MyFlipFlop (IN, RST)

FFLD MyFlipFlop.Q

ST Q1

See also

R S SR

3.2.2 F_TRIG PLCopen

Function Block - Falling pulse detection

3.2.2.1 Inputs

CLK : BOOL Boolean signal

3.2.2.2 Outputs

Q : BOOL TRUE when the input changes from TRUE to FALSE



3.2.2.3 Truth table

CLK	CLK <i>prev</i>	Q
0	0	0
0	1	1
1	0	0
1	1	0

3.2.2.4 Remarks

Although]P[and]N[contacts can be used in FFLD language, it is recommended to use declared instances of R_TRIG or F_TRIG function blocks in order to avoid contingencies during an Online Change.

3.2.2.5 ST Language

(* MyTrigger is declared as an instance of F_TRIG function block *)

```
MyTrigger (CLK);
Q := MyTrigger.Q;
```

3.2.2.6 FBD Language



3.2.2.7 FFLD Language

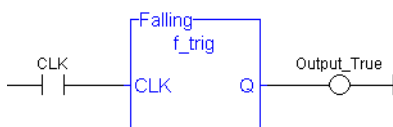

3.2.2.8 IL Language:

(* MyTrigger is declared as an instance of F_TRIG function block *)

```
Op1: CAL MyTrigger (CLK)
LD MyTrigger.Q
ST Q
```

See also

[R_TRIG](#)

3.2.3 NOT PLCopen 

Operator - Performs a Boolean negation of the input.

3.2.3.1 Inputs

IN : BOOL Boolean value

3.2.3.2 Outputs

Q : BOOL Boolean negation of the input

3.2.3.3 Truth table

IN	Q
0	1
1	0

3.2.3.4 Remarks

In FBD language, the block "NOT" can be used. Alternatively, you can use a link terminated by a "o" negation. In FFLD language, negated contacts and coils can be used. In IL language, the "N" modifier can be used with instructions FFLD, AND, OR, XOR and ST. It represents a negation of the operand. In ST language, NOT can be followed by a complex Boolean expression between parentheses.

3.2.3.5 ST Language

Q := NOT IN;

Q := NOT (IN1 OR IN2);

3.2.3.6 FBD Language

(* explicit use of the "NOT" block *)



(* use of a negated link: Q is IN1 AND NOT IN2 *)

**3.2.3.7 FFLD Language**

(* Negated contact: Q is: IN1 AND NOT IN2 *)

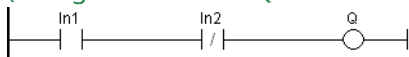

(* Negated coil: Q is NOT (IN1 AND IN2) *)

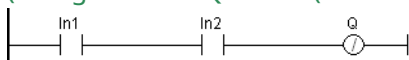
**3.2.3.8 IL Language:**

```
Op1: FFLDN IN1
      OR IN2
      ST Q (* Q is equal to: (NOT IN1) OR IN2 *)
Op2: FFLD IN1
      AND IN2
      STN Q (* Q is equal to: NOT (IN1 AND IN2) *)
```

See also

AND OR [XOR](#)

3.2.4 QOR PLCopen

Operator - Count the number of TRUE inputs.

3.2.4.1 Inputs

IN1 ... INn : BOOL Boolean inputs

3.2.4.2 Outputs

Q : DINT Number of inputs being TRUE

3.2.4.3 Remarks

The block accepts a non-fixed number of inputs.

3.2.4.4 ST Language

```
Q := QOR (IN1, IN2);
Q := QOR (IN1, IN2, IN3, IN4, IN5, IN6);
```

3.2.4.5 FBD Language

(* the block may have up to 16 inputs *)

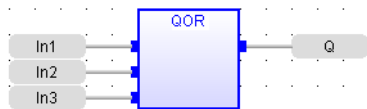

3.2.4.6 FFLD Language

(* the block may have up to 16 inputs *)

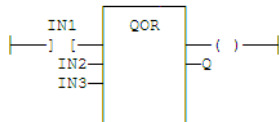

3.2.4.7 IL Language

```
Op1: LD IN1
      QOR IN2, IN3
      ST Q
```

3.2.5 R

Operator - Force a Boolean output to FALSE.

3.2.5.1 Inputs

RESET : BOOL Condition

3.2.5.2 Outputs

Q : BOOL Output to be forced

3.2.5.3 Truth table

RESET	Q <i>prev</i>	Q
0	0	0
0	1	1
1	0	0
1	1	0

3.2.5.4 Remarks

S and R operators are available as standard instructions in the IL language. In FFLD languages they are represented by (S) and (R) coils. In FBD language, you can use (S) and (R) coils, but you must prefer RS and SR function blocks. Set and reset operations are not available in ST language.

3.2.5.5 ST Language

Not available.

3.2.5.6 FBD Language

Not available. Use RS or SR function blocks.

3.2.5.7 FFLD Language

(* use of "R" coil *)



3.2.5.8 IL Language:

Op1: FFLD RESET

R Q (* Q is forced to FALSE if RESET is TRUE *)
 (* Q is unchanged if RESET is FALSE *)

See also

[S](#) [RS](#) [SR](#)

3.2.6 RS PLCopen

Function Block - Reset dominant bistable.

3.2.6.1 Inputs

SET : BOOL Condition for forcing to TRUE
 RESET1 : BOOL Condition for forcing to FALSE (highest priority command)

3.2.6.2 Outputs

Q1 : BOOL Output to be forced

3.2.6.3 Truth table

SET	RESET1	Q1 <i>prev</i>	Q1
0	0	0	0
0	0	1	1
0	1	0	0
0	1	1	0
1	0	0	1
1	0	1	1
1	1	0	0
1	1	1	0

3.2.6.4 Remarks

The output is unchanged when both inputs are FALSE. When both inputs are TRUE, the output is forced to FALSE (reset dominant).

3.2.6.5 ST Language

```
(* MyRS is declared as an instance of RS function block *)
MyRS (SET, RESET1);
Q1 := MyRS.Q1;
```

3.2.6.6 FBD Language

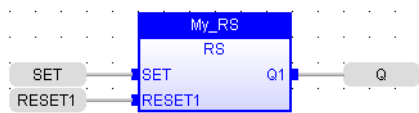

3.2.6.7 FFLD Language

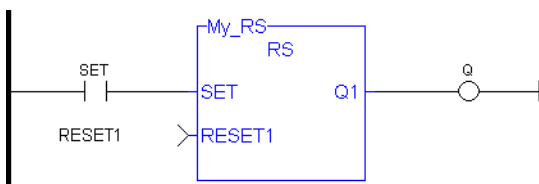

3.2.6.8 IL Language:

```
(* MyRS is declared as an instance of RS function block *)
Op1: CAL MyRS (SET, RESET1)
      FFLD MyRS.Q1
      ST Q1
```

See also

[R S SR](#)

3.2.7 R_TRIG PLCopen

Function Block - Rising pulse detection

3.2.7.1 Inputs

CLK : BOOL Boolean signal

3.2.7.2 Outputs

Q : BOOL TRUE when the input changes from FALSE to TRUE



3.2.7.3 Truth table

CLK	CLK <i>prev</i>	Q
0	0	0
0	1	0
1	0	1
1	1	0

3.2.7.4 Remarks

Although]P[and]N[contacts can be used in FFLD language, it is recommended to use declared instances of R_TRIG or F_TRIG function blocks in order to avoid contingencies during an Online Change.

3.2.7.5 ST Language

```
(* MyTrigger is declared as an instance of R_TRIG function block *)
MyTrigger (CLK);
Q := MyTrigger.Q;
```

3.2.7.6 FBD Language



3.2.7.7 FFLD Language

(* the input signal is the rung - the rung is the output *)

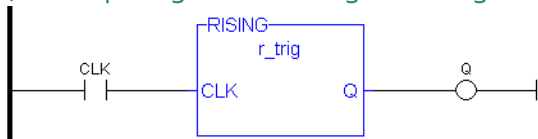

3.2.7.8 IL Language:

```
(* MyTrigger is declared as an instance of R_TRIG function block *)
Op1: CAL MyTrigger (CLK)
FFLD MyTrigger.Q
ST Q
```

See also

[F_TRIG](#)

3.2.8 S

Operator - Force a Boolean output to TRUE.

3.2.8.1 Inputs

SET : BOOL Condition

3.2.8.2 Outputs

Q : BOOL Output to be forced

3.2.8.3 Truth table

SET	Q prev	Q
0	0	0
0	1	1
1	0	1
1	1	1

3.2.8.4 Remarks

S and R operators are available as standard instructions in the IL language. In FFLD languages they are represented by (S) and (R) coils. In FBD language, you can use (S) and (R) coils, but you must prefer RS and SR function blocks. Set and reset operations are not available in ST language.

3.2.8.5 ST Language

Not available.

3.2.8.6 FBD Language

Not available. Use RS or SR function blocks.

3.2.8.7 FFLD Language

(* use of "S" coil *)

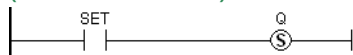

3.2.8.8 IL Language:

Op1: FFLD SET

S Q (* Q is forced to TRUE if SET is TRUE *)
 (* Q is unchanged if SET is FALSE *)

See also

R RS SR

3.2.9 SEMA PLCopen

Function Block - Semaphore.

3.2.9.1 Inputs

CLAIM : BOOL Takes the semaphore
 RELEASE : BOOL Releases the semaphore

3.2.9.2 Outputs

BUSY : BOOL True if semaphore is busy

3.2.9.3 Remarks

The function block implements the following algorithm:

```
BUSY := mem;
if CLAIM then
    mem := TRUE;
else if RELEASE then
    BUSY := FALSE;
    mem := FALSE;
end_if;
```

In FFLD language, the input rung is the CLAIM command. The output rung is the BUSY output signal.

3.2.9.4 ST Language

(* MySema is a declared instance of SEMA function block *)

```
MySema (CLAIM, RELEASE);
BUSY := MyBlinker.BUSY;
```

3.2.9.5 FBD Language

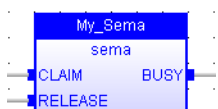

3.2.9.6 FFLD Language

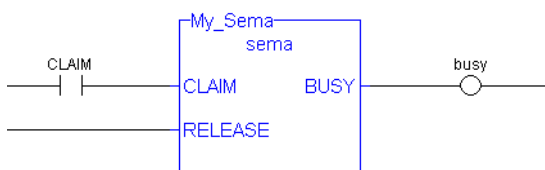

3.2.9.7 IL Language:

(* MySema is a declared instance of SEMA function block *)

```
Op1: CAL MySema (CLAIM, RELEASE)
FFLD MyBlinker.BUSY
ST BUSY
```

3.2.10 SR PLCopen 

Function Block - Set dominant bistable.

3.2.10.1 Inputs

SET1 : BOOL Condition for forcing to TRUE (highest priority command)
 RESET : BOOL Condition for forcing to FALSE

3.2.10.2 Outputs

Q1 : BOOL Output to be forced

3.2.10.3 Truth table

SET1	RESET	Q1 <i>prev</i>	Q1
0	0	0	0
0	0	1	1
0	1	0	0
0	1	1	0
1	0	0	1
1	0	1	1
1	1	0	1
1	1	1	1

3.2.10.4 Remarks

The output is unchanged when both inputs are FALSE. When both inputs are TRUE, the output is forced to TRUE (set dominant).

3.2.10.5 ST Language

```
(* MySR is declared as an instance of SR function block *)
MySR (SET1, RESET);
Q1 := MySR.Q1;
```

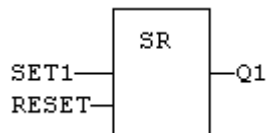
3.2.10.6 FBD Language

3.2.10.7 FFLD Language

(* the SET1 command is the rung - the rung is the output *)

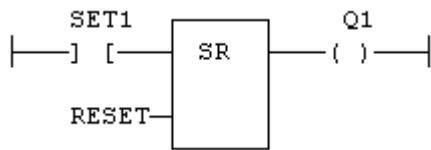

3.2.10.8 IL Language:

```
(* MySR is declared as an instance of SR function block *)
Op1: CAL MySR (SET1, RESET)
      FFLD MySR.Q1
      ST Q1
```

See also

[R](#) [S](#) [RS](#)

3.2.11 XOR XORN PLCopen

Operator - Performs an exclusive OR of all inputs.

3.2.11.1 Inputs

IN1 : BOOL First Boolean input
IN2 : BOOL Second Boolean input

3.2.11.2 Outputs

Q : BOOL Exclusive OR of all inputs

3.2.11.3 Truth table

IN1	IN2	Q
0	0	0
0	1	1
1	0	1
1	1	0

3.2.11.4 Remarks

The block is called "=1" in FBD and FFLD languages. In IL language, the XOR instruction performs an exclusive OR between the current result and the operand. The current result must be Boolean. The XORN instruction performs an exclusive between the current result and the Boolean negation of the operand.

3.2.11.5 ST Language

Q := IN1 XOR IN2;
Q := IN1 XOR IN2 XOR IN3;

3.2.11.6 FBD Language

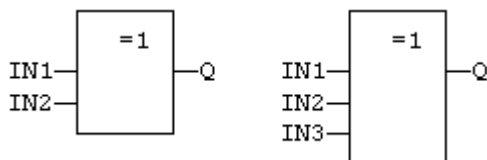

3.2.11.7 FFLD Language

(* First input is the rung. The rung is the output *)

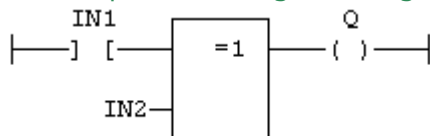

3.2.11.8 IL Language

```
Op1: FFLD  IN1
      XOR  IN2
      ST   Q   (* Q is equal to: IN1 XOR IN2 *)
Op2: FFLD  IN1
```

```
XORN IN2
ST Q (* Q is equal to: IN1 XOR (NOT IN2) *)
```

See also

AND OR NOT

3.3 Arithmetic operations PLCopen 

Below are the standard operators that perform arithmetic operations:

+ Addition	addition
- Subtraction	subtraction
* Multiply	multiplication
/ Divide	division
- (NEG)	integer negation (unary operator)

Below are the standard functions that perform arithmetic operations:

MIN	get the minimum of two integers or an ANY
MAX	get the maximum of two integers or an ANY
LIMIT	bound an integer to low and high limits or an ANY
MOD	modulo
ODD	test if an integer is odd
SetWithin	Force a value when within an interval

3.3.1+ Addition

Operator - Performs an addition of all inputs.

3.3.1.1 Inputs

```
IN1 : ANY   First input
IN2 : ANY   Second input
```

3.3.1.2 Outputs

```
Q : ANY     Result: IN1 + IN2
```

3.3.1.3 Remarks

All inputs and the output must have the same type. In FBD language, the block can have up to 16 inputs. In FLD language, the input rung (EN) enables the operation, and the output rung keeps the same value as the input rung. In IL language, the ADD instruction performs an addition between the current result and the operand. The current result and the operand must have the same type.

The addition can be used with strings. The result is the concatenation of the input strings.

3.3.1.4 ST Language

```
Q := IN1 + IN2;
MyString := 'He' + 'll ' + 'o';    (* MyString is equal to 'Hello' *)
```

3.3.1.5 FBD Language

(* the block can have up to 16 inputs *)

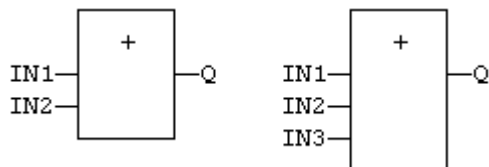

3.3.1.6 FLD Language

(* The addition is executed only if EN is TRUE *)

(* ENO is equal to EN *)

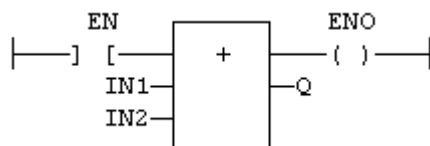

3.3.1.7 IL Language

```
Op1: FFLD IN1
      ADD IN2
      ST Q      (* Q is equal to: IN1 + IN2 *)
Op2: FFLD IN1
      ADD IN2
      ADD IN3
      ST Q      (* Q is equal to: IN1 + IN2 + IN3 *)
```

See also

- * /

3.3.2/ Divide

Operator - Performs a division of inputs.

3.3.2.1 Inputs

IN1 : ANY_NUM First input
IN2 : ANY_NUM Second input

3.3.2.2 Outputs

Q : ANY_NUM Result: IN1 / IN2

3.3.2.3 Remarks

All inputs and the output must have the same type. In FFLD language, the input rung (EN) enables the operation, and the output rung keeps the same value as the input rung. In IL language, the DIV instruction performs a division between the current result and the operand. The current result and the operand must have the same type.

3.3.2.4 ST Language

Q := IN1 / IN2;

3.3.2.5 FBD Language

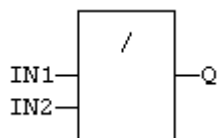

3.3.2.6 FFLD Language

(* The division is executed only if EN is TRUE *)

(* ENO is equal to EN *)

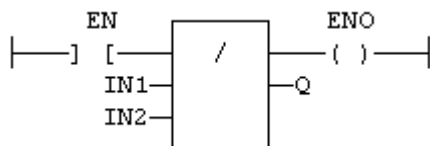

3.3.2.7 IL Language:

Op1: FFLD IN1
DIV IN2
ST Q (* Q is equal to: IN1 / IN2 *)
Op2: FFLD IN1
DIV IN2
DIV IN3
ST Q (* Q is equal to: IN1 / IN2 / IN3 *)

See also

+ - *

3.3.3 NEG - PLCopen

Operator - Performs an integer negation of the input.

3.3.3.1 Inputs

IN : DINT Integer value

3.3.3.2 Outputs

Q : DINT Integer negation of the input

3.3.3.3 Truth table (examples)

IN	Q
0	0
1	-1
-123	123

3.3.3.4 Remarks

- In FBD and FFLD language, the block "NEG" can be used.
- In FFLD language, the operation is executed only if the input rung (EN) is TRUE. The output rung (ENO) keeps the same value as the input rung.
- This feature is not available in IL language. In ST language, "-" can be followed by a complex Boolean expression between parentheses.

3.3.3.5 ST Language

```
Q := -IN;
Q := - (IN1 + IN2);
```

3.3.3.6 FBD Language



3.3.3.7 FFLD Language

(* The negation is executed only if EN is TRUE *)

(* ENO keeps the same value as EN *)

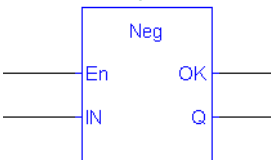

3.3.4 LIMIT PLCopen

Function - Bounds an integer between low and high limits.

3.3.4.1 Inputs

IMIN : DINT Low bound
 IN : DINT Inputvalue
 IMAX : DINT High bound

3.3.4.2 Outputs

Q : DINT IMIN if $IN < IMIN$; IMAX if $IN > IMAX$; IN otherwise

3.3.4.3 Function diagram

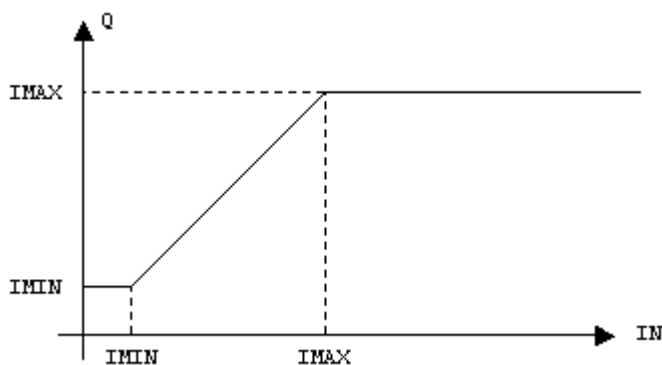

3.3.4.4 Remarks

In FLD language, the input rung (EN) enables the operation, and the output rung keeps the state of the input rung. In IL language, the first input must be loaded before the function call. Other inputs are operands of the function, separated by a coma.

3.3.4.5 ST Language

Q := LIMIT (IMIN, IN, IMAX);

3.3.4.6 FBD Language

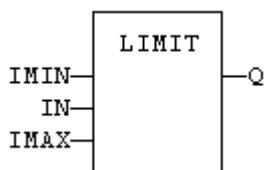

3.3.4.7 FFLD Language

(* The comparison is executed only if EN is TRUE *)

(* ENO has the same value as EN *)

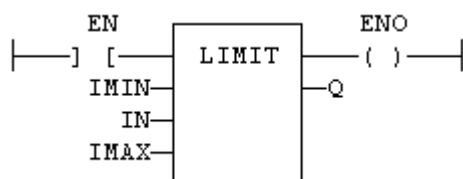

3.3.4.8 IL Language:

Op1: LD IMIN
LIMIT IN, IMAX
ST Q

See also

[MIN](#) [MAX](#) [MOD](#) [ODD](#)

3.3.5 MAX PLCopen

Function - Get the maximum of two integers.

3.3.5.1 Inputs

IN1 : DINT First input
IN2 : DINT Second input

3.3.5.2 Outputs

Q : DINT IN1 if $IN1 > IN2$; IN2 otherwise

3.3.5.3 Remarks

In FFLD language, the input rung (EN) enables the operation, and the output rung keeps the state of the input rung. In IL language, the first input must be loaded before the function call. The second input is the operand of the function.

3.3.5.4 ST Language

Q := MAX (IN1, IN2);

3.3.5.5 FBD Language

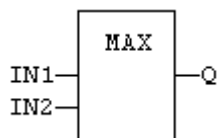

3.3.5.6 FFLD Language

(* The comparison is executed only if EN is TRUE *)
(* ENO has the same value as EN *)

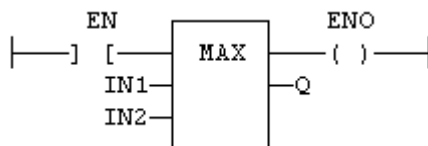

3.3.5.7 IL Language:

Op1: LD IN1
MAX IN2
ST Q (* Q is the maximum of IN1 and IN2 *)

See also

[MIN](#) [LIMIT](#) [MOD](#) [ODD](#)

3.3.6 MIN PLCopen

Function - Get the minimum of two integers.

3.3.6.1 Inputs

IN1 : DINT First input
 IN2 : DINT Second input

3.3.6.2 Outputs

Q : DINT IN1 if $IN1 < IN2$; IN2 otherwise

3.3.6.3 Remarks

In FFLD language, the input rung (EN) enables the operation, and the output rung keeps the state of the input rung. In IL language, the first input must be loaded before the function call. The second input is the operand of the function.

3.3.6.4 ST Language

Q := MIN (IN1, IN2);

3.3.6.5 FBD Language

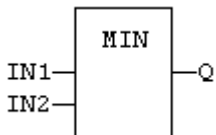

3.3.6.6 FFLD Language

(* The comparison is executed only if EN is TRUE *)
 (* ENO has the same value as EN *)

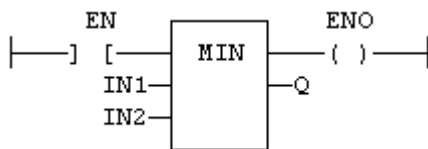

3.3.6.7 IL Language:

Op1: LD IN1
 MIN IN2
 ST Q (* Q is the minimum of IN1 and IN2 *)

See also

[MAX](#) [LIMIT](#) [MOD](#) [ODD](#)

3.3.7 MOD / MODR / MODLR PLCopen

Function - Calculation of modulo.

The modulo is calculated as follows:

$$Q = IN - \text{Trunc}(IN/BASE) * BASE$$

where *Trunc(x)* calculates the truncated (rounded toward zero) value of x.

NOTE

If BASE = 0, then Q will return 0.

If IN = 0, then Q will return 0.

Inputs	Function			Description	
	MOD	MODR	MODLR		
IN	DINT	REAL	LREAL	Input value	
BASE	DINT	REAL	LREAL	Base of the modulo	
Output	Function			Description	Range
	MOD	MODR	MODLR		
Q	DINT	REAL	LREAL	Modulo result	(-BASE, BASE)

3.3.7.1 Examples

MOD Examples

IN	BASE	Q
11	7	4
7	7	0
5	7	5
0	7	0
-5	7	-5
-7	7	0
-11	7	-4
11	-7	4
7	-7	0
5	-7	5
0	-7	0
-5	-7	-5
-7	-7	0
-11	-7	-4
5	0	0

MODR / MODLR Examples

IN	BASE	Q
9.00	5.75	3.25

IN	BASE	Q
5.75	5.75	0
2.50	5.75	2.50
0	5.75	0
-2.50	5.75	-2.5
-5.75	5.75	0
-9.00	5.75	-3.25
9.00	-5.75	3.25
5.75	-5.75	0
2.50	-5.75	2.50
0	-5.75	0
-2.50	-5.75	-2.5
-5.75	-5.75	0
-9.00	-5.75	-3.25
4.25	0	0

3.3.7.2 Remarks

The MOD family of functions can return negative numbers. By adding BASE to the result, the modulo value may be forced to a positive number if the range is required to be [0, BASE). An example of how to accomplish this in ST code follows.

```

q := MOD(x, base);
IF q < 0 THEN
    q := q + base;
END_IF;
    
```

In FFLD language, the input rung (EN) enables the operation, and the output rung keeps the state of the input rung. In IL language, the first input must be loaded before the function call. The second input is the operand of the function.

3.3.7.3 ST Language

Q := MOD (IN, BASE);

3.3.7.4 FBD Language

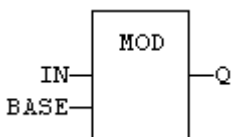

3.3.7.5 FFLD Language

(* The comparison is executed only if EN is TRUE *)

(* ENO has the same value as EN *)

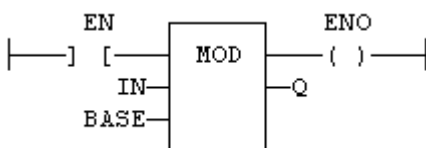

3.3.7.6 IL Language

Op1: LD IN

MOD BASE

ST Q (* Q is the rest of integer division: $IN / BASE *$)

See also

[MIN](#) [MAX](#) [LIMIT](#) [ODD](#)

3.3.8 * Multiply

Operator - Performs a multiplication of all inputs.

3.3.8.1 Inputs

IN1 : ANY_NUM First input
 IN2 : ANY_NUM Second input

3.3.8.2 Outputs

Q : ANY_NUM Result: IN1 * IN2

3.3.8.3 Remarks

All inputs and the output must have the same type. In FBD language, the block can have up to 16 inputs. In FFLD language, the input rung (EN) enables the operation, and the output rung keeps the same value as the input rung. In IL language, the MUL instruction performs a multiplication between the current result and the operand. The current result and the operand must have the same type.

3.3.8.4 ST Language

Q := IN1 * IN2;

3.3.8.5 FBD Language

(* the block can have up to 16 inputs *)

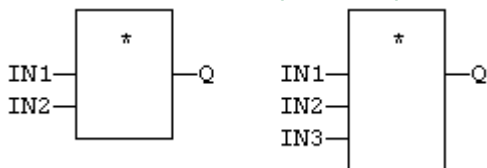

3.3.8.6 FFLD Language

(* The multiplication is executed only if EN is TRUE *)
 (* ENO is equal to EN *)

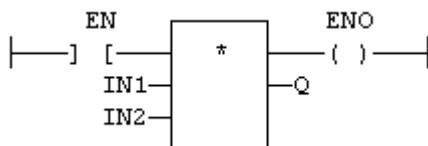

3.3.8.7 IL Language:

Op1: FFLD IN1
 MUL IN2
 ST Q (* Q is equal to: IN1 * IN2 *)
 Op2: FFLD IN1
 MUL IN2
 MUL IN3
 ST Q (* Q is equal to: IN1 * IN2 * IN3 *)

See also

+ - /

3.3.9 ODD PLCopen 

Function - Test if an integer is odd

3.3.9.1 Inputs

IN : DINT Input value

3.3.9.2 Outputs

Q : BOOL TRUE if IN is odd. FALSE if IN is even.

3.3.9.3 Remarks

In FFLD language, the input rung (EN) enables the operation, and the output rung is the result of the function. In IL language, the input must be loaded before the function call.

3.3.9.4 ST Language

Q := ODD (IN);

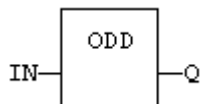
3.3.9.5 FBD Language**3.3.9.6 FFLD Language**

(* The function is executed only if EN is TRUE *)

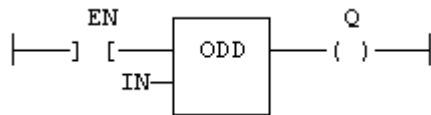
**3.3.9.7 IL Language:**

Op1: LD IN

ODD

ST Q (* Q is TRUE if IN is odd *)

See also

[MIN](#) [MAX](#) [LIMIT](#) [MOD](#)

3.3.10 SetWithin PLCopen

Function - Force a value when inside an interval.

3.3.10.1 Inputs

IN : ANY Input

MIN : ANY Low limit of the interval

MAX : ANY High limit of the interval

VAL : ANY Value to apply when inside the interval

3.3.10.2 Outputs

Q : ANY Result

3.3.10.3 Truth Table

In	Q
IN < MIN	IN
IN > MAX	IN
MIN < IN < MAX	VAL

3.3.10.4 Remarks

The output is forced to VAL when the IN value is within the [MIN ... MAX] interval. It is set to IN when outside the interval.

3.3.11 - Subtraction

Operator - Performs a subtraction of inputs.

3.3.11.1 Inputs

IN1 : ANY_NUM / TIME First input
IN2 : ANY_NUM / TIME Second input

3.3.11.2 Outputs

Q : ANY_NUM / TIME Result: IN1 - IN2

3.3.11.3 Remarks

All inputs and the output must have the same type. In FFLD language, the input rung (EN) enables the operation, and the output rung keeps the same value as the input rung. In IL language, the SUB instruction performs a subtraction between the current result and the operand. The current result and the operand must have the same type.

3.3.11.4 ST Language

Q := IN1 - IN2;

3.3.11.5 FBD Language

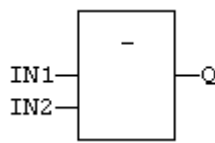

3.3.11.6 FFLD Language

(* The subtraction is executed only if EN is TRUE *)
(* ENO is equal to EN *)

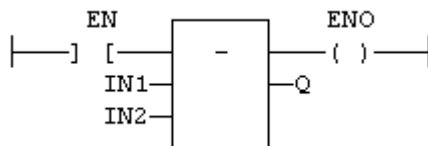

3.3.11.7 IL Language:

Op1: FFLD IN1
SUB IN2
ST Q (* Q is equal to: IN1 - IN2 *)
Op2: FFLD IN1
SUB IN2
SUB IN3
ST Q (* Q is equal to: IN1 - IN2 - IN3 *)

See also

+ * /

3.4 Comparison Operations PLCopen

Below are the standard operators and blocks that perform comparisons:

<	less than
>	greater than
<=	less or equal
>=	greater or equal
=	is equal
<>	is not equal
CMP	detailed comparison

3.4.1 CMP PLCopen

Function Block - Comparison with detailed outputs for integer inputs

3.4.1.1 Inputs

IN1 : DINT First value
IN2 : DINT Second value

3.4.1.2 Outputs

LT : BOOL TRUE if IN1 < IN2
EQ : BOOL TRUE if IN1 = IN2
GT : BOOL TRUE if IN1 > IN2

3.4.1.3 Remarks

In FFLD language, the rung input (EN) validates the operation. The rung output is the result of "LT" (lower than) comparison).

3.4.1.4 ST Language

(* MyCmp is declared as an instance of CMP function block *)

```
MyCMP (IN1, IN2);
bLT := MyCmp.LT;
bEQ := MyCmp.EQ;
bGT := MyCmp.GT;
```

3.4.1.5 FBD Language

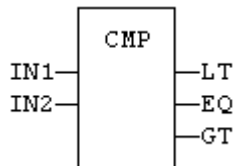

3.4.1.6 FFLD Language

(* the comparison is performed only if EN is TRUE *)

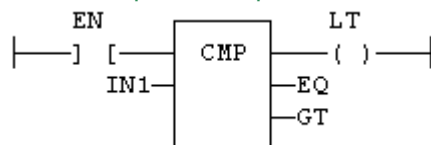

3.4.1.7 IL Language:

(* MyCmp is declared as an instance of CMP function block *)

```
Op1: CAL MyCmp (IN1, IN2)
  LD MyCmp.LT
  ST bLT
  LD MyCmp.EQ
  ST bEQ
  LD MyCmp.GT
  ST bGT
```

See also

> < >= <= = <>

3.4.2 >= GE PLCopen 

Operator - Test if first input is greater than or equal to second input.

3.4.2.1 Inputs

IN1 : ANY First input
IN2 : ANY Second input

3.4.2.2 Outputs

Q : BOOL TRUE if IN1 >= IN2

3.4.2.3 Remarks

Both inputs must have the same type. In FFLD language, the input rung (EN) enables the operation, and the output rung is the result of the comparison. In IL language, the GE instruction performs the comparison between the current result and the operand. The current result and the operand must have the same type.

Comparisons can be used with strings. In that case, the lexical order is used for comparing the input strings. For instance, "ABC" is less than "ZX"; "ABCD" is greater than "ABC".

3.4.2.4 ST Language

Q := IN1 >= IN2;

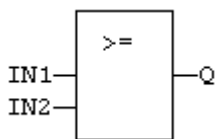
3.4.2.5 FBD Language**3.4.2.6 FFLD Language**

(* The comparison is executed only if EN is TRUE *)

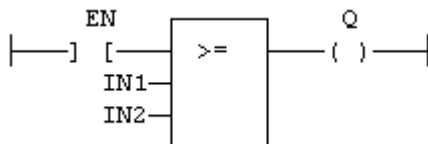
**3.4.2.7 IL Language:**

Op1: FFLD IN1
GE IN2
ST Q (* Q is true if IN1 >= IN2 *)

See also

> < <= = <> CMP

3.4.3 > GT PLCopen 

Operator - Test if first input is greater than second input.

3.4.3.1 Inputs

IN1 : ANY First input
IN2 : ANY Second input

3.4.3.2 Outputs

Q : BOOL TRUE if IN1 > IN2

3.4.3.3 Remarks

Both inputs must have the same type. In FFLD language, the input rung (EN) enables the operation, and the output rung is the result of the comparison. In IL language, the GT instruction performs the comparison between the current result and the operand. The current result and the operand must have the same type.

Comparisons can be used with strings. In that case, the lexical order is used for comparing the input strings. For instance, "ABC" is less than "ZX"; "ABCD" is greater than "ABC".

3.4.3.4 ST Language

Q := IN1 > IN2;

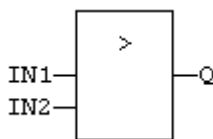
3.4.3.5 FBD Language**3.4.3.6 FFLD Language**

(* The comparison is executed only if EN is TRUE *)

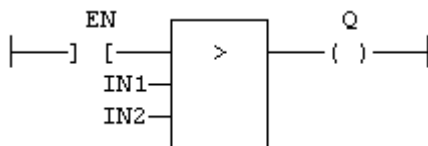
**3.4.3.7 IL Language:**

Op1: FFLD IN1
GT IN2
ST Q (* Q is true if IN1 > IN2 *)

See also

< >= <= = <> CMP

3.4.4 = EQ PLCopen

Operator - Test if first input is equal to second input.

3.4.4.1 Inputs

IN1 : ANY First input
 IN2 : ANY Second input

3.4.4.2 Outputs

Q : BOOL TRUE if IN1 = IN2

3.4.4.3 Remarks

Both inputs must have the same type. In FFLD language, the input rung (EN) enables the operation, and the output rung is the result of the comparison. In IL language, the EQ instruction performs the comparison between the current result and the operand. The current result and the operand must have the same type.

Comparisons can be used with strings. In that case, the lexical order is used for comparing the input strings. For instance, "ABC" is less than "ZX"; "ABCD" is greater than "ABC".

Equality comparisons cannot be used with TIME variables. The reason is that the timer actually has the resolution of the target cycle and test can be unsafe as some values can never be reached.

3.4.4.4 ST Language

Q := IN1 = IN2;

3.4.4.5 FBD Language

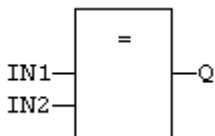

3.4.4.6 FFLD Language

(* The comparison is executed only if EN is TRUE *)

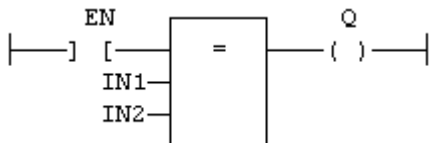

3.4.4.7 IL Language:

Op1: FFLD IN1
 EQ IN2
 ST Q (* Q is true if IN1 = IN2 *)

See also

> < >= <= <> CMP

3.4.5 <> NE PLCopen

Operator - Test if first input is not equal to second input.

3.4.5.1 Inputs

IN1 : ANY First input
 IN2 : ANY Second input

3.4.5.2 Outputs

Q : BOOL TRUE if IN1 is not equal to IN2

3.4.5.3 Remarks

Both inputs must have the same type. In FFLD language, the input rung (EN) enables the operation, and the output rung is the result of the comparison. In IL language, the NE instruction performs the comparison between the current result and the operand. The current result and the operand must have the same type.

Comparisons can be used with strings. In that case, the lexical order is used for comparing the input strings. For instance, "ABC" is less than "ZX"; "ABCD" is greater than "ABC".

Equality comparisons cannot be used with TIME variables. The reason is that the timer actually has the resolution of the target cycle and test can be unsafe as some values can never be reached

3.4.5.4 ST Language

Q := IN1 <> IN2;

3.4.5.5 FBD Language

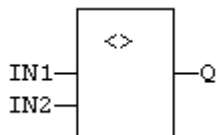

3.4.5.6 FFLD Language

(* The comparison is executed only if EN is TRUE *)

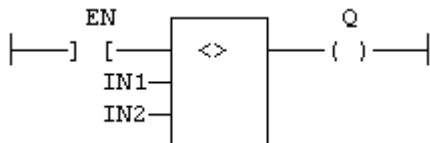

3.4.5.7 IL Language:

Op1: FFLD IN1
 NE IN2
 ST Q (* Q is true if IN1 is not equal to IN2 *)

See also

> < >= <= = CMP

3.4.6 <= LE PLCopen 

Operator - Test if first input is less than or equal to second input.

3.4.6.1 Inputs

IN1 : ANY First input
IN2 : ANY Second input

3.4.6.2 Outputs

Q : BOOL TRUE if IN1 <= IN2

3.4.6.3 Remarks

Both inputs must have the same type. In FFLD language, the input rung (EN) enables the operation, and the output rung is the result of the comparison. In IL language, the LE instruction performs the comparison between the current result and the operand. The current result and the operand must have the same type.

Comparisons can be used with strings. In that case, the lexical order is used for comparing the input strings. For instance, "ABC" is less than "ZX"; "ABCD" is greater than "ABC".

3.4.6.4 ST Language

Q := IN1 <= IN2;

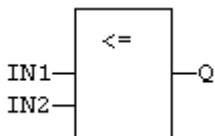
3.4.6.5 FBD Language**3.4.6.6 FFLD Language**

(* The comparison is executed only if EN is TRUE *)

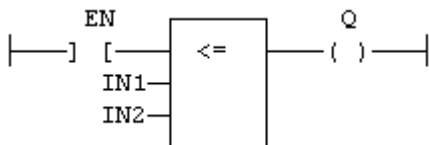
**3.4.6.7 IL Language:**

Op1: FFLD IN1
LE IN2
ST Q (* Q is true if IN1 <= IN2 *)

See also

> < >= = <> CMP

3.4.7 < LT PLCopen 

Operator - Test if first input is less than second input.

3.4.7.1 Inputs

IN1 : ANY First input
IN2 : ANY Second input

3.4.7.2 Outputs

Q : BOOL TRUE if IN1 < IN2

3.4.7.3 Remarks

Both inputs must have the same type. In FFLD language, the input rung (EN) enables the operation, and the output rung is the result of the comparison. In IL language, the LT instruction performs the comparison between the current result and the operand. The current result and the operand must have the same type.

Comparisons can be used with strings. In that case, the lexical order is used for comparing the input strings. For instance, "ABC" is less than "ZX"; "ABCD" is greater than "ABC".

3.4.7.4 ST Language

Q := IN1 < IN2;

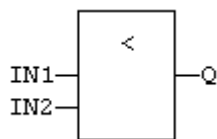
3.4.7.5 FBD Language**3.4.7.6 FFLD Language**

(* The comparison is executed only if EN is TRUE *)

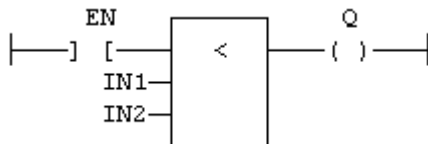
**3.4.7.7 IL Language:**

Op1: FFLD IN1
LT IN2
ST Q (* Q is true if IN1 < IN2 *)

See also

> >= <= = <> CMP

3.5 Type conversion functions

Below are the standard functions for converting a data into another data type:

<code>ANY_TO_BOOL</code>	converts to Boolean
<code>ANY_TO_SINT / ANY_TO_USINT</code>	converts to small (8 bit) integer
<code>ANY_TO_INT / ANY_TO_UINT</code>	converts to 16 bit integer
<code>ANY_TO_DINT / ANY_TO_UDINT</code>	converts to integer (32 bit - default)
<code>ANY_TO_LINT / ANY_TO_ULINT</code>	converts to long (64 bit) integer
<code>ANY_TO_REAL</code>	converts to real
<code>ANY_TO_LREAL</code>	converts to double precision real
<code>ANY_TO_TIME</code>	converts to time
<code>ANY_TO_STRING</code>	converts to character string

Below are the standard functions performing conversions in BCD format (*):

<code>BIN_TO_BCD</code>	converts a binary value to a BCD value
<code>BCD_TO_BIN</code>	converts a BCD value to a binary value

(*) BCD conversion functions may not be supported by all targets.

3.5.1 ANY_TO_BOOL PLCopen

Operator - Converts the input into Boolean value.

3.5.1.1 Inputs

IN : ANY Input value

3.5.1.2 Outputs

Q : BOOL Value converted to Boolean

3.5.1.3 Remarks

For DINT, REAL and TIME input data types, the result is FALSE if the input is 0. The result is TRUE in all other cases. For STRING inputs, the output is TRUE if the input string is not empty, and FALSE if the string is empty. In FFLD language, the conversion is executed only if the input rung (EN) is TRUE. The output rung is the result of the conversion. In IL Language, the ANY_TO_BOOL function converts the current result.

3.5.1.4 ST Language

Q := ANY_TO_BOOL (IN);

3.5.1.5 FBD Language

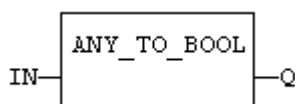

3.5.1.6 FFLD Language

(* The conversion is executed only if EN is TRUE *)
 (* The output rung is the result of the conversion *)
 (* The output rung is FALSE if the EN is FALSE *)

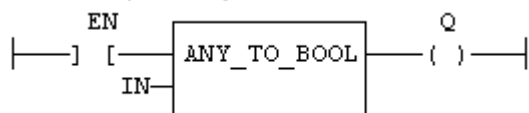

3.5.1.7 IL Language:

Op1: FFLD IN
 ANY_TO_BOOL
 ST Q

3.5.1.8 See also

[ANY_TO_SINT](#) [ANY_TO_INT](#) [ANY_TO_DINT](#) [ANY_TO_LINT](#) [ANY_TO_REAL](#) [ANY_TO_LREAL](#) [ANY_TO_TIME](#) [ANY_TO_STRING](#)

3.5.2 ANY_TO_DINT / ANY_TO_UDINT PLCopen

Operator - Converts the input into integer value (can be unsigned with ANY_TO_UDINT).

3.5.2.1 Inputs

IN : ANY Input value

3.5.2.2 Outputs

Q : DINT Value converted to integer

3.5.2.3 Remarks

For BOOL input data types, the output is 0 or 1. For REAL input data type, the output is the integer part of the input real. For TIME input data types, the result is the number of milliseconds. For STRING inputs, the output is the number represented by the string, or 0 if the string does not represent a valid number. In FFLD language, the conversion is executed only if the input rung (EN) is TRUE. The output rung (ENO) keeps the same value as the input rung. In IL Language, the ANY_TO_DINT function converts the current result.

3.5.2.4 ST Language

Q := ANY_TO_DINT (IN);

3.5.2.5 FBD Language

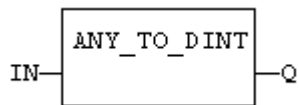

3.5.2.6 FFLD Language

(* The conversion is executed only if EN is TRUE *)

(* ENO keeps the same value as EN *)

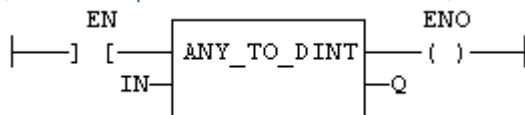

3.5.2.7 IL Language:

Op1: FFLD IN
 ANY_TO_DINT
 ST Q

3.5.2.8 See also

[ANY_TO_BOOL](#) [ANY_TO_SINT](#) [ANY_TO_INT](#) [ANY_TO_LINT](#) [ANY_TO_REAL](#) [ANY_TO_LREAL](#) [ANY_TO_TIME](#) [ANY_TO_STRING](#)

3.5.3 ANY_TO_INT / ANY_TO_UINT PLCopen

Operator - Converts the input into 16 bit integer value (can be unsigned with ANY_TO_UINT).

3.5.3.1 Inputs

IN : ANY Input value

3.5.3.2 Outputs

Q : INT Value converted to 16 bit integer

3.5.3.3 Remarks

For BOOL input data types, the output is 0 or 1. For REAL input data type, the output is the integer part of the input real. For TIME input data types, the result is the number of milliseconds. For STRING inputs, the output is the number represented by the string, or 0 if the string does not represent a valid number. In FFLD language, the conversion is executed only if the input rung (EN) is TRUE. The output rung (ENO) keeps the same value as the input rung. In IL Language, the ANY_TO_INT function converts the current result.

3.5.3.4 ST Language

Q := ANY_TO_INT (IN);

3.5.3.5 FBD Language

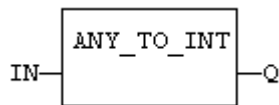

3.5.3.6 FFLD Language

(* The conversion is executed only if EN is TRUE *)

(* ENO keeps the same value as EN *)

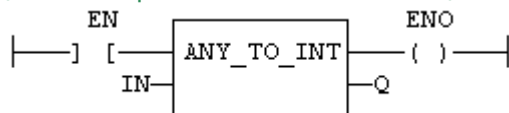

3.5.3.7 IL Language:

Op1: FFLD IN
 ANY_TO_INT
 ST Q

3.5.3.8 See also

[ANY_TO_BOOL](#) [ANY_TO_SINT](#) [ANY_TO_DINT](#) [ANY_TO_LINT](#) [ANY_TO_REAL](#) [ANY_TO_LREAL](#) [ANY_TO_TIME](#) [ANY_TO_STRING](#)

3.5.4 ANY_TO_LINT / ANY_TO_ULINT PLCopen

Operator - Converts the input into long (64 bit) integer value (can be unsigned with ANY_TO_ULINT).

3.5.4.1 Inputs

IN : ANY Input value

3.5.4.2 Outputs

Q : LINT Value converted to long (64 bit) integer

3.5.4.3 Remarks

For BOOL input data types, the output is 0 or 1. For REAL input data type, the output is the integer part of the input real. For TIME input data types, the result is the number of milliseconds. For STRING inputs, the output is the number represented by the string, or 0 if the string does not represent a valid number. In FFLD language, the conversion is executed only if the input rung (EN) is TRUE. The output rung (ENO) keeps the same value as the input rung. In IL Language, the ANY_TO_LINT function converts the current result.

3.5.4.4 ST Language

Q := ANY_TO_LINT (IN);

3.5.4.5 FBD Language

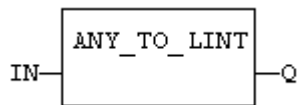

3.5.4.6 FFLD Language

(* The conversion is executed only if EN is TRUE *)

(* ENO keeps the same value as EN *)

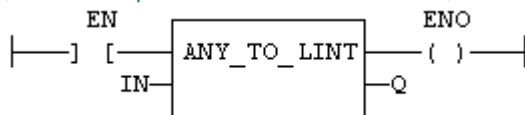

3.5.4.7 IL Language:

Op1: FFLD IN
 ANY_TO_LINT
 ST Q

3.5.4.8 See also

[ANY_TO_BOOL](#) [ANY_TO_SINT](#) [ANY_TO_INT](#) [ANY_TO_DINT](#) [ANY_TO_REAL](#) [ANY_TO_LREAL](#) [ANY_TO_TIME](#) [ANY_TO_STRING](#)

3.5.5 ANY_TO_LREAL PLCopen

Operator - Converts the input into double precision real value.

3.5.5.1 Inputs

IN : ANY Input value

3.5.5.2 Outputs

Q : LREAL Value converted to double precision real

3.5.5.3 Remarks

For BOOL input data types, the output is 0.0 or 1.0. For DINT input data type, the output is the same number. For TIME input data types, the result is the number of milliseconds. For STRING inputs, the output is the number represented by the string, or 0.0 if the string does not represent a valid number. In FFLD language, the conversion is executed only if the input rung (EN) is TRUE. The output rung (ENO) keeps the same value as the input rung. In IL Language, the ANY_TO_LREAL function converts the current result.

3.5.5.4 ST Language

Q := ANY_TO_LREAL (IN);

3.5.5.5 FBD Language

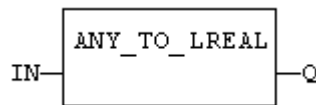

3.5.5.6 FFLD Language

(* The conversion is executed only if EN is TRUE *)

(* ENO keeps the same value as EN *)

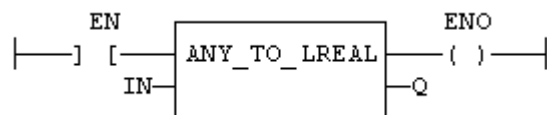

3.5.5.7 IL Language:

```
Op1: FFLD IN
  ANY_TO_LREAL
  ST Q
```

3.5.5.8 See also

[ANY_TO_BOOL](#) [ANY_TO_SINT](#) [ANY_TO_INT](#) [ANY_TO_DINT](#) [ANY_TO_LINT](#) [ANY_TO_REAL](#) [ANY_TO_TIME](#) [ANY_TO_STRING](#)

3.5.6 ANY_TO_REAL PLCopen ✓

Operator - Converts the input into real value.

3.5.6.1 Inputs

IN : ANY Input value

3.5.6.2 Outputs

Q : REAL Value converted to real

3.5.6.3 Remarks

For BOOL input data types, the output is 0.0 or 1.0. For DINT input data type, the output is the same number. For TIME input data types, the result is the number of milliseconds. For STRING inputs, the output is the number represented by the string, or 0.0 if the string does not represent a valid number. In FFLD language, the conversion is executed only if the input rung (EN) is TRUE. The output rung (ENO) keeps the same value as the input rung. In IL Language, the ANY_TO_REAL function converts the current result.

3.5.6.4 ST Language

Q := ANY_TO_REAL (IN);

3.5.6.5 FBD Language

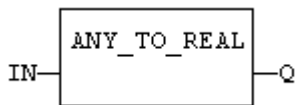

3.5.6.6 FFLD Language

(* The conversion is executed only if EN is TRUE *)

(* ENO keeps the same value as EN *)

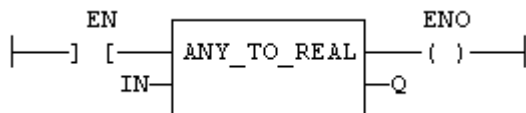

3.5.6.7 IL Language:

Op1: FFLD IN
 ANY_TO_REAL
 ST Q

3.5.6.8 See also

[ANY_TO_BOOL](#) [ANY_TO_SINT](#) [ANY_TO_INT](#) [ANY_TO_DINT](#) [ANY_TO_LINT](#) [ANY_TO_LREAL](#) [ANY_TO_TIME](#) [ANY_TO_STRING](#)

3.5.7 ANY_TO_TIME PLCopen

Operator - Converts the input into time value.

3.5.7.1 Inputs

IN : ANY Input value

3.5.7.2 Outputs

Q : TIME Value converted to time

3.5.7.3 Remarks

For BOOL input data types, the output is t#0 ms or t#1 ms. For DINT or REAL input data type, the output is the time represented by the input number as a number of milliseconds. For STRING inputs, the output is the time represented by the string, or t#0 ms if the string does not represent a valid time. In FFLD language, the conversion is executed only if the input rung (EN) is TRUE. The output rung (ENO) keeps the same value as the input rung. In IL Language, the ANY_TO_TIME function converts the current result.

3.5.7.4 ST Language

Q := ANY_TO_TIME (IN);

3.5.7.5 FBD Language

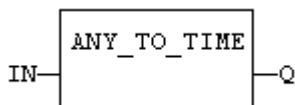

3.5.7.6 FFLD Language

(* The conversion is executed only if EN is TRUE *)

(* ENO keeps the same value as EN *)

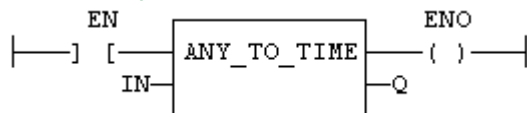

3.5.7.7 IL Language:

Op1: FFLD IN
 ANY_TO_TIME
 ST Q

3.5.7.8 See also

[ANY_TO_BOOL](#) [ANY_TO_SINT](#) [ANY_TO_INT](#) [ANY_TO_DINT](#) [ANY_TO_LINT](#) [ANY_TO_REAL](#) [ANY_TO_LREAL](#) [ANY_TO_STRING](#)

3.5.8 ANY_TO_SINT / ANY_TO_USINT PLCopen

Operator - Converts the input into a small (8 bit) integer value (can be unsigned with ANY_TO_USINT).

3.5.8.1 Inputs

IN : ANY Input value

3.5.8.2 Outputs

Q : SINT Value converted to a small (8 bit) integer

3.5.8.3 Remarks

For BOOL input data types, the output is 0 or 1. For REAL input data type, the output is the integer part of the input real. For TIME input data types, the result is the number of milliseconds. For STRING inputs, the output is the number represented by the string, or 0 if the string does not represent a valid number. In FLD language, the conversion is executed only if the input rung (EN) is TRUE. The output rung (ENO) keeps the same value as the input rung. In IL Language, the ANY_TO_SINT function converts the current result.

3.5.8.4 ST Language

Q := ANY_TO_SINT (IN);

3.5.8.5 FBD Language

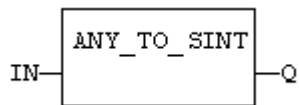

3.5.8.6 FLD Language

(* The conversion is executed only if EN is TRUE *)

(* ENO keeps the same value as EN *)

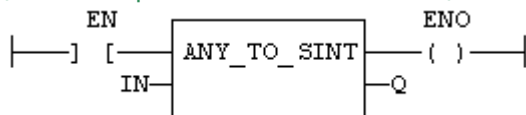

3.5.8.7 IL Language

Op1: FFLD IN
 ANY_TO_SINT
 ST Q

3.5.8.8 See also

[ANY_TO_BOOL](#) [ANY_TO_INT](#) [ANY_TO_DINT](#) [ANY_TO_LINT](#) [ANY_TO_REAL](#) [ANY_TO_LREAL](#) [ANY_TO_TIME](#) [ANY_TO_STRING](#)

3.5.9 ANY_TO_STRING PLCopen

Operator - Converts the input into string value.

3.5.9.1 Inputs

IN : ANY Input value

3.5.9.2 Outputs

Q : STRING Value converted to string

3.5.9.3 Remarks

For BOOL input data types, the output is '1' or '0' for TRUE and FALSE respectively. For DINT, REAL or TIME input data types, the output is the string representation of the input number. It is a number of milliseconds for TIME inputs. In FLD language, the conversion is executed only if the input rung (EN) is TRUE. The output rung (ENO) keeps the same value as the input rung. In IL language, the ANY_TO_STRING function converts the current result.

3.5.9.4 ST Language

Q := ANY_TO_STRING (IN);

3.5.9.5 FBD Language

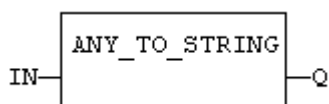

3.5.9.6 FLD Language

(* The conversion is executed only if EN is TRUE *)

(* ENO keeps the same value as EN *)

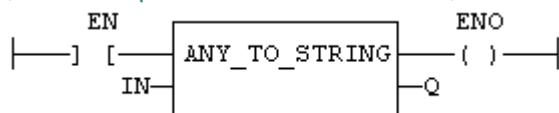

3.5.9.7 IL Language:

```
Op1: FFLD IN
  ANY_TO_STRING
  ST Q
```

3.5.9.8 See also

[ANY_TO_BOOL](#) [ANY_TO_SINT](#) [ANY_TO_INT](#) [ANY_TO_DINT](#) [ANY_TO_LINT](#) [ANY_TO_REAL](#) [ANY_TO_LREAL](#) [ANY_TO_TIME](#)

3.5.10 NUM_TO_STRING

Function- Converts a number into string value.

3.5.10.1 Inputs

IN : ANY Input number.

WIDTH : DINT Wished length for the output string (see remarks)

DIGITS : DINT Number of digits after decimal point

3.5.10.2 Outputs

Q : STRING Value converted to string.

3.5.10.3 Remarks

This function converts any numerical value to a string. Unlike the ANY_TO_STRING function, it allows you to specify a wished length and a number of digits after the decimal points.

If WIDTH is 0, the string is formatted with the necessary length.

If WIDTH is greater than 0, the string is completed with heading blank characters in order to match the value of WIDTH.

If WIDTH is greater than 0, the string is completed with trailing blank characters in order to match the absolute value of WIDTH.

If DIGITS is 0 then neither decimal part nor point are added.

If DIGITS is greater than 0, the corresponding number of decimal digits are added. '0' digits are added if necessary

If the value is too long for the specified width, then the string is filled with '*' characters.

3.5.10.4 Examples

```
Q := NUM_TO_STRING (123.4, 8, 2); (* Q is ' 123.40' *)
```

```
Q := NUM_TO_STRING (123.4, -8, 2); (* Q is '123.40 ' *)
```

```
Q := NUM_TO_STRING (1.333333, 0, 2); (* Q is '1.33' *)
```

```
Q := NUM_TO_STRING (1234, 3, 0); (* Q is '***' *)
```

3.5.11 BCD_TO_BIN PLCopen

Function - Converts a BCD (Binary Coded Decimal) value to a binary value

3.5.11.1 Inputs

IN : DINT Integer value in BCD

3.5.11.2 Outputs

Q : DINT Value converted to integer, or 0 if IN is not a valid positive BCD value

3.5.11.3.1 Truth table (examples)

IN	Q
-2	0 (invalid)
0	0
16 (16#10)	10
15 (16#0F)	0 (invalid)

3.5.11.4 Remarks

The input must be positive and must represent a valid BCD value. In FFLD language, the operation is executed only if the input rung (EN) is TRUE. The output rung (ENO) keeps the same value as the input rung.

In IL, the input must be loaded in the current result before calling the function.

3.5.11.5 ST Language

Q := BCD_TO_BIN (IN);

3.5.11.6 FBD Language

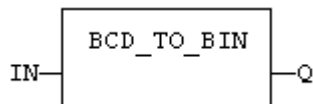

3.5.11.7 FFLD Language

(* The function is executed only if EN is TRUE *)

(* ENO keeps the same value as EN *)

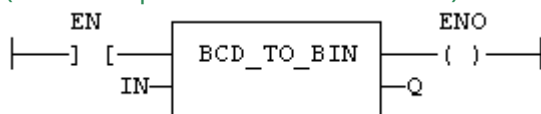

3.5.11.8 IL Language

```
Op1: LD      IN
      BCD_TO_BIN
      ST      Q
```

See also

[BIN_TO_BCD](#)

3.5.12 BIN_TO_BCD PLCopen

Function - Converts a binary value to a BCD (Binary Coded Decimal) value

3.5.12.1 Inputs

IN : DINT Integer value

3.5.12.2 Outputs

Q : DINT Value converted to BCD
or 0 if IN is less than 0

3.5.12.3 Truth table (examples)

IN	Q
-2	0 (invalid)
0	0
10	16 (16#10)
22	34 (16#22)

3.5.12.4 Remarks

The input must be positive. In FFLD language, the operation is executed only if the input rung (EN) is TRUE. The output rung (ENO) keeps the same value as the input rung.

In IL, the input must be loaded in the current result before calling the function.

3.5.12.5 ST Language

Q := BIN_TO_BCD (IN);

3.5.12.6 FBD Language

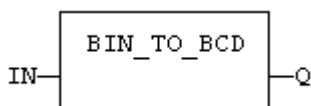

3.5.12.7 FFLD Language

(* The function is executed only if EN is TRUE *)
(* ENO keeps the same value as EN *)

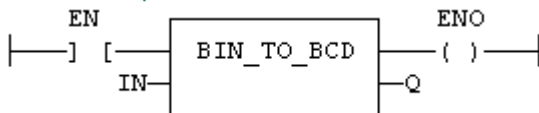

3.5.12.8 IL Language:

```
Op1: LD   IN
      BIN_TO_BCD
      ST   Q
```

See also

[BCD_TO_BIN](#)

3.6 Selectors

Below are the standard functions that perform data selection:

SEL	2 integer inputs
MUX4	4 integer inputs
MUX8	8 integer inputs

3.6.1 MUX4 PLCopen

Function - Select one of the inputs - 4 inputs.

3.6.1.1 Inputs

SELECT : DINT Selection command
 IN1 : ANY First input
 IN2 : ANY Second input
 ... :
 IN4 : ANY Last input

3.6.1.2 Outputs

Q : ANY IN1 or IN2 ... or IN4 depending on SELECT (see truth table)

3.6.1.3 Truth table

SELECT	Q
0	IN1
1	IN2
2	IN3
3	IN4
other	0

3.6.1.4 Remarks

In FFLD language, the input rung (EN) enables the selection. The output rung keeps the same state as the input rung. In IL language, the first parameter (selector) must be loaded in the current result before calling the function. Other inputs are operands of the function, separated by comas.

3.6.1.5 ST Language

Q := MUX4 (SELECT, IN1, IN2, IN3, IN4);

3.6.1.6 FBD Language

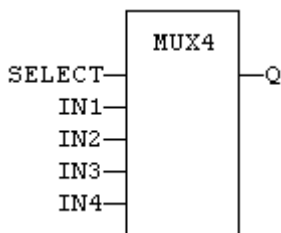

3.6.1.7 FFLD Language

(* the selection is performed only if EN is TRUE *)
(* ENO has the same value as EN *)

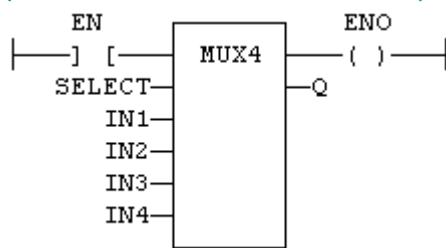

3.6.1.8 IL Language

```
Op1: LD SELECT
      MUX4 IN1, IN2, IN3, IN4
      ST Q
```

See also

[SEL MUX8](#)

3.6.2 MUX8 PLCopen

Function - Select one of the inputs - 8 inputs.

3.6.2.1 Inputs

SELECT : DINT Selection command
 IN1 : ANY First input
 IN2 : ANY Second input
 ... :
 IN8 : ANY Last input

3.6.2.2 Outputs

Q : ANY IN1 or IN2 ... or IN8 depending on SELECT (see truth table)

3.6.2.3 Truth table

SELECT	Q
0	IN1
1	IN2
2	IN3
3	IN4
4	IN5
5	IN6
6	IN7
7	IN8
other	0

3.6.2.4 Remarks

In FFLD language, the input rung (EN) enables the selection. The output rung keeps the same state as the input rung. In IL language, the first parameter (selector) must be loaded in the current result before calling the function. Other inputs are operands of the function, separated by comas.

3.6.2.5 ST Language

Q := MUX8 (SELECT, IN1, IN2, IN3, IN4, IN5, IN6, IN7, IN8);

3.6.2.6 FBD Language

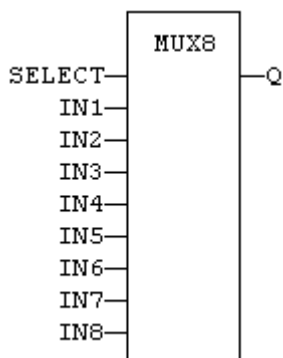

3.6.2.7 FFLD Language

(* the selection is performed only if EN is TRUE *)
 (* ENO has the same value as EN *)

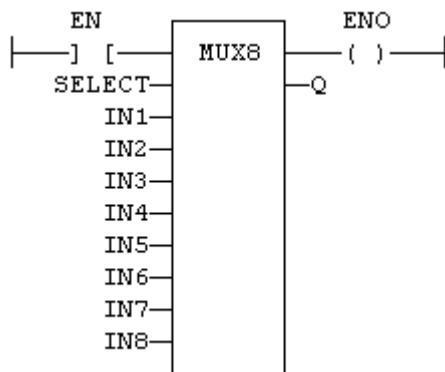

3.6.2.8 IL Language

Not available

```
Op1: LD SELECT
      MUX8 IN1, IN2, IN3, IN4, IN5, IN6, IN7, IN8
      ST Q
```

See also

[SEL MUX4](#)

3.6.3 SEL PLCopen

Function - Select one of the inputs - 2 inputs.

3.6.3.1 Inputs

SELECT : BOOL Selection command
 IN1 : ANY First input
 IN2 : ANY Second input

3.6.3.2 Outputs

Q : ANY IN1 if SELECT is FALSE; IN2 if SELECT is TRUE

3.6.3.3 Truth table

SELECT	Q
0	IN1
1	IN2

3.6.3.4 Remarks

In FFLD language, the selector command is the input rung. The output rung keeps the same state as the input rung. In IL language, the first parameter (selector) must be loaded in the current result before calling the function. Other inputs are operands of the function, separated by comas.

3.6.3.5 ST Language

Q := SEL (SELECT, IN1, IN2);

3.6.3.6 FBD Language

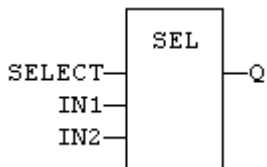

3.6.3.7 FFLD Language

(* the input rung is the selector *)
 (* ENO has the same value as SELECT *)

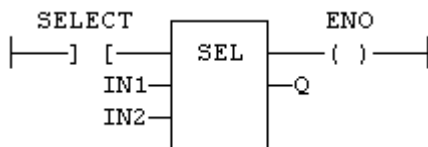

3.6.3.8 IL Language

Op1: LD SELECT
 SEL IN1, IN2
 ST Q

See also

[MUX4](#) [MUX8](#)

3.7 Registers

Below are the standard functions for managing 8 bit to 32 bit registers:

SHL	shift left
SHR	shift right
ROL	rotation left
ROR	rotation right

Below are advanced functions for register manipulation:

MBSHift	multibyte shift / rotate
---------	--------------------------

The following functions enable bit to bit operations on a 8 bit to 32 bit integers:

AND_MASK	Boolean AND
OR_MASK	Boolean OR
XOR_MASK	exclusive OR
NOT_MASK	Boolean negation

The following functions enable to pack/unpack 8, 16 and 32 bit registers

LOBYTE	Get the lowest byte of a word
HIBYTE	Get the highest byte of a word
LOWORD	Get the lowest word of a double word
HIWORD	Get the highest word of a double word
MAKEWORD	Pack bytes to a word
MAKEDWORD	Pack words to a double word
PACK8	Pack bits in a byte
UNPACK8	Extract bits from a byte

The following functions provide bit access in 8 bit to 32 bit integers:

SETBIT	Set a bit in a register
TESTBIT	Test a bit of a register

The following functions have been deprecated. They are available for backwards compatibility only. The functions listed above should be used for all current and future development.

AND_WORD	AND_BYTE
OR_WORD	OR_BYTE
NOT_WORD	NOT_BYTE
XOR_WORD	XOR_BYTE
ROLW	RORW
ROLB	RORB
SHLW	SHRW
SHLB	SHRB

3.7.1 AND_MASK PLCopen

Function - Performs a bit to bit AND between two integer values

3.7.1.1 Inputs

IN : ANY First input
 MSK : ANY Second input (AND mask)

3.7.1.2 Outputs

Q : ANY AND mask between IN and MSK inputs

3.7.1.3 Remarks

Arguments can be signed or unsigned integers from 8 to 32 bits.

In FFLD language, the input rung (EN) enables the operation, and the output rung keeps the same value as the input rung. In IL language, the first parameter (IN) must be loaded in the current result before calling the function. The other input is the operands of the function.

3.7.1.4 ST Language

Q := AND_MASK (IN, MSK);

3.7.1.5 FBD Language

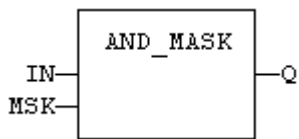

3.7.1.6 FFLD Language

(* The function is executed only if EN is TRUE *)
 (* ENO is equal to EN *)

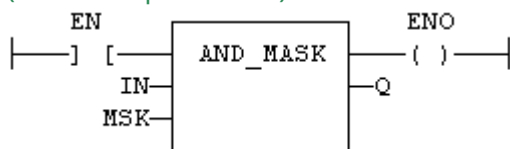

3.7.1.7 IL Language:

```
Op1: LD  IN
      AND_MASK MSK
      ST  Q
```

See also

[OR_MASK](#) [XOR_MASK](#) [NOT_MASK](#)

3.7.2 HIBYTE PLCopen

Function - Get the most significant byte of a word

3.7.2.1 Inputs

IN : UINT 16 bit register

3.7.2.2 Outputs

Q : USINT Most significant byte

3.7.2.3 Remarks

In FLD language, the operation is executed only if the input rung (EN) is TRUE. The output rung (ENO) keeps the same value as the input rung.

In IL, the input must be loaded in the current result before calling the function.

3.7.2.4 ST Language

Q := HIBYTE (IN);

3.7.2.5 FBD Language

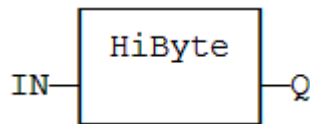

3.7.2.6 FLD Language

(* The function is executed only if EN is TRUE *)
 (* ENO keeps the same value as EN *)

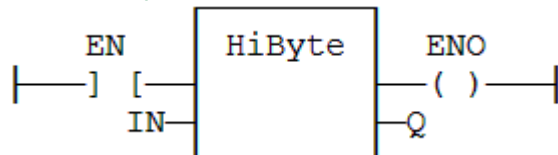

3.7.2.7 IL Language:

Op1: LD IN
 HIBYTE
 ST Q

See also

[LOBYTE](#) [LOWORD](#) [HIWORD](#) [MAKEWORD](#) [MAKEDWORD](#)

3.7.3 LOBYTE PLCopen

Function - Get the less significant byte of a word

3.7.3.1 Inputs

IN : UINT 16 bit register

3.7.3.2 Outputs

Q : USINT Lowest significant byte

3.7.3.3 Remarks

In FFLD language, the operation is executed only if the input rung (EN) is TRUE. The output rung (ENO) keeps the same value as the input rung.

In IL, the input must be loaded in the current result before calling the function.

3.7.3.4 ST Language

Q := LOBYTE (IN);

3.7.3.5 FBD Language

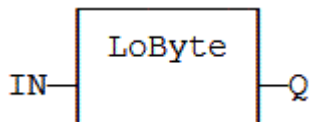

3.7.3.6 FFLD Language

(* The function is executed only if EN is TRUE *)
 (* ENO keeps the same value as EN *)

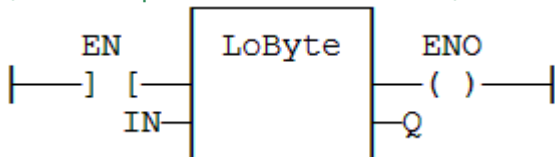

3.7.3.7 IL Language:

```
Op1: LD IN
      LOBYTE
      ST Q
```

See also

[HIBYTE](#) [LOWORD](#) [HIWORD](#) [MAKEWORD](#) [MAKEDWORD](#)

3.7.4 HIWORD PLCopen

Function - Get the most significant word of a double word

3.7.4.1 Inputs

IN : UDINT 32 bit register

3.7.4.2 Outputs

Q : UINT Most significant word

3.7.4.3 Remarks

In FFLD language, the operation is executed only if the input rung (EN) is TRUE. The output rung (ENO) keeps the same value as the input rung.

In IL, the input must be loaded in the current result before calling the function.

3.7.4.4 ST Language

Q := HIWORD (IN);

3.7.4.5 FBD Language

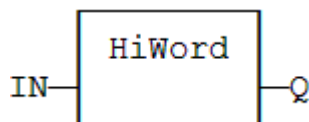

3.7.4.6 FFLD Language

(* The function is executed only if EN is TRUE *)
 (* ENO keeps the same value as EN *)

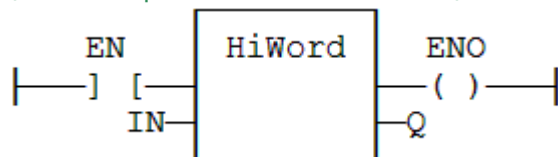

3.7.4.7 IL Language:

Op1: LD IN
 HIWORD
 ST Q

See also

[LOBYTE](#) [HIBYTE](#) [LOWORD](#) [MAKEWORD](#) [MAKEDWORD](#)

3.7.5 LOWORD PLCopen

Function - Get the less significant word of a double word

3.7.5.1 Inputs

IN : UDINT 32 bit register

3.7.5.2 Outputs

Q : UINT Lowest significant word

3.7.5.3 Remarks

In FFLD language, the operation is executed only if the input rung (EN) is TRUE. The output rung (ENO) keeps the same value as the input rung.

In IL, the input must be loaded in the current result before calling the function.

3.7.5.4 ST Language

Q := LOWORD (IN);

3.7.5.5 FBD Language

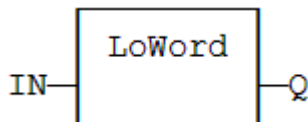

3.7.5.6 FFLD Language

(* The function is executed only if EN is TRUE *)
 (* ENO keeps the same value as EN *)

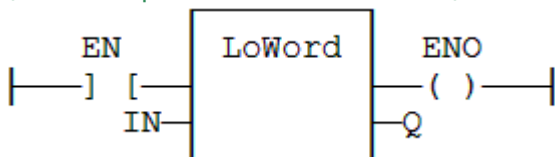

3.7.5.7 IL Language:

Op1: LD IN
 LOWORD
 ST Q

See also

[LOBYTE](#) [HIBYTE](#) [HIWORD](#) [MAKEWORD](#) [MAKEDWORD](#)

3.7.6 MAKEDWORD PLCopen

Function - Builds a double word as the concatenation of two words

3.7.6.1 Inputs

HI : USINT Highest significant word
LO : USINT Lowest significant word

3.7.6.2 Outputs

Q : UINT 32 bit register

3.7.6.3 Remarks

In FFLD language, the operation is executed only if the input rung (EN) is TRUE. The output rung (ENO) keeps the same value as the input rung.

In IL, the first input must be loaded in the current result before calling the function.

3.7.6.4 ST Language

Q := MAKEDWORD (HI, LO);

3.7.6.5 FBD Language

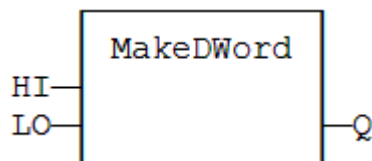

3.7.6.6 FFLD Language

(* The function is executed only if EN is TRUE *)
(* ENO keeps the same value as EN *)

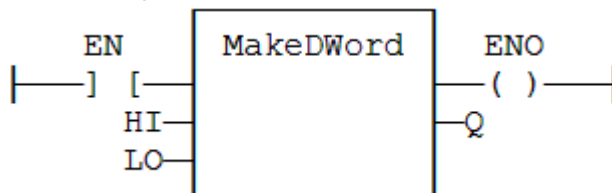

3.7.6.7 IL Language:

```
Op1: LD  HI
      MAKEDWORD LO
      ST  Q
```

See also

[LOBYTE](#) [HIBYTE](#) [LOWORD](#) [HIWORD](#) [MAKEWORD](#)

3.7.7 MAKEWORD PLCopen

Function - Builds a word as the concatenation of two bytes

3.7.7.1 Inputs

HI : USINT Highest significant byte
 LO : USINT Lowest significant byte

3.7.7.2 Outputs

Q : UINT 16 bit register

3.7.7.3 Remarks

In FFLD language, the operation is executed only if the input rung (EN) is TRUE. The output rung (ENO) keeps the same value as the input rung.

In IL, the first input must be loaded in the current result before calling the function.

3.7.7.4 ST Language

Q := MAKEWORD (HI, LO);

3.7.7.5 FBD Language

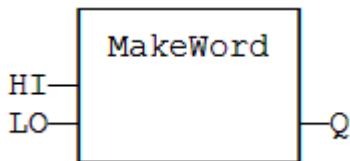

3.7.7.6 FFLD Language

(* The function is executed only if EN is TRUE *)
 (* ENO keeps the same value as EN *)

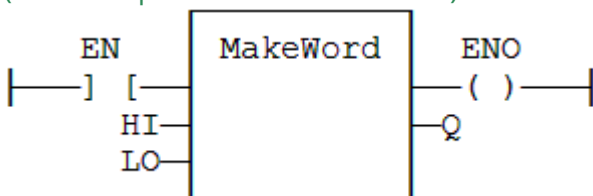

3.7.7.7 IL Language:

Op1: LD HI
 MAKEWORD LO
 ST Q

See also

[LOBYTE](#) [HIBYTE](#) [LOWORD](#) [HIWORD](#) [MAKEDWORD](#)

3.7.9 NOT_MASK PLCopen

Function - Performs a bit to bit negation of an integer value

3.7.9.1 Inputs

IN : ANY Integer input

3.7.9.2 Outputs

Q : ANY Bit to bit negation of the input

3.7.9.3 Remarks

Arguments can be signed or unsigned integers from 8 to 32 bits.

In FFLD language, the input rung (EN) enables the operation, and the output rung keeps the same value as the input rung. In IL language, the parameter (IN) must be loaded in the current result before calling the function.

3.7.9.4 ST Language

Q := NOT_MASK(IN);

3.7.9.5 FBD Language

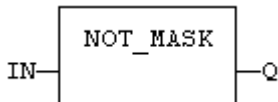

3.7.9.6 FFLD Language

(* The function is executed only if EN is TRUE *)

(* ENO is equal to EN *)

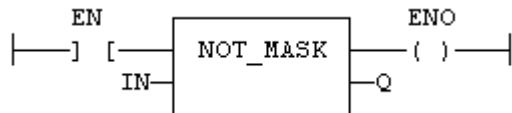

3.7.9.7 IL Language:

```
Op1: LD  IN
      NOT_MASK
      ST  Q
```

See also

[AND_MASK](#) [OR_MASK](#) [XOR_MASK](#)

3.7.10 OR_MASK PLCopen 

Function - Performs a bit to bit OR between two integer values

3.7.10.1 Inputs

IN : ANY First input
MSK : ANY Second input (OR mask)

3.7.10.2 Outputs

Q : ANY OR mask between IN and MSK inputs

3.7.10.3 Remarks

Arguments can be signed or unsigned integers from 8 to 32 bits.

In FLD language, the input rung (EN) enables the operation, and the output rung keeps the same value as the input rung. In IL language, the first parameter (IN) must be loaded in the current result before calling the function. The other input is the operands of the function.

3.7.10.4 ST Language

Q := OR_MASK (IN, MSK);

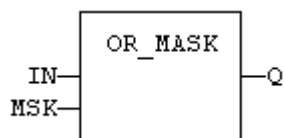
3.7.10.5 FBD Language**3.7.10.6 FFLD Language**

(* The function is executed only if EN is TRUE *)

(* ENO is equal to EN *)

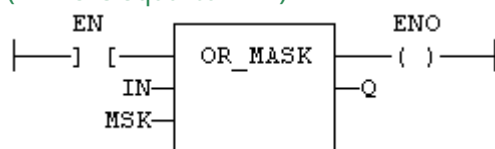
**3.7.10.7 IL Language:**

```
Op1: LD  IN
      OR_MASK MSK
      ST  Q
```

See also

[AND_MASK](#) [XOR_MASK](#) [NOT_MASK](#)

3.7.11 PACK8 PLCopen

Function - Builds a byte with bits

3.7.11.1 Inputs

IN0 : BOOL Less significant bit
...
IN7 : BOOL Most significant bit

3.7.11.2 Outputs

Q : USINT Byte built with input bits

3.7.11.3 Remarks

- In FFLD language, the input rung is the IN0 input. The output rung (ENO) keeps the same value as the input rung.
- In IL, the input must be loaded in the current result before calling the function.

3.7.11.4 ST Language

```
Q := PACK8 (IN0, IN1, IN2, IN3, IN4, IN5, IN6, IN7);
```

3.7.11.5 FBD Language

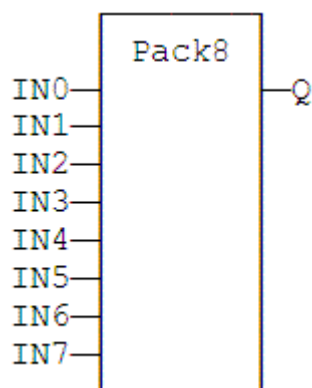

3.7.11.6 FFLD Language

(* ENO keeps the same value as EN *)

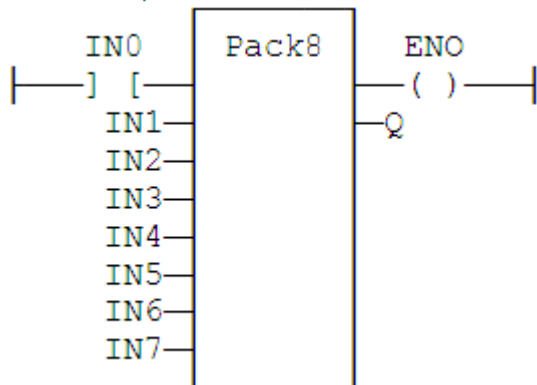

3.7.11.7 IL Language

```
Op1: LD    IN0
      PACK8 IN1, IN2, IN3, IN4, IN5, IN6, IN7
      ST    Q
```

See also

[UNPACK8](#)

3.7.12 ROL PLCopen

Function - Rotate bits of a register to the left.

3.7.12.1 Inputs

IN : ANY register
 NBR : DINT Number of rotations (each rotation is 1 bit)

3.7.12.2 Outputs

Q : ANY Rotated register

3.7.12.3 Diagram

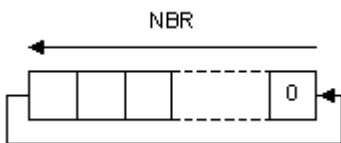

3.7.12.4 Remarks

Arguments can be signed or unsigned integers from 8 to 32 bits.

In FFLD language, the input rung (EN) enables the operation, and the output rung keeps the state of the input rung. In IL language, the first input must be loaded before the function call. The second input is the operand of the function.

3.7.12.5 ST Language

Q := ROL (IN, NBR);

3.7.12.6 FBD Language

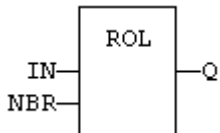

3.7.12.7 FFLD Language

(* The rotation is executed only if EN is TRUE *)
 (* ENO has the same value as EN *)

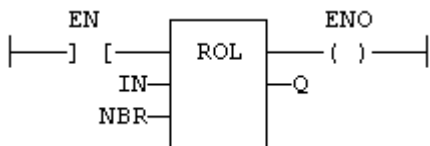

3.7.12.8 IL Language:

```
Op1: LD IN
      ROL NBR
      ST Q
```

See also

[SHL](#) [SHR](#) [ROR](#)

3.7.13 ROR PLCopen 

Function - Rotate bits of a register to the right.

3.7.13.1 Inputs

IN : ANY register

NBR : ANY Number of rotations (each rotation is 1 bit)

3.7.13.2 Outputs

Q : ANY Rotated register

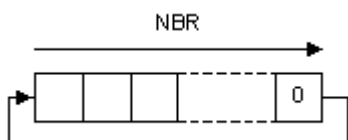
3.7.13.3 Diagram**3.7.13.4 Remarks**

Arguments can be signed or unsigned integers from 8 to 32 bits.

In FLD language, the input rung (EN) enables the operation, and the output rung keeps the state of the input rung. In IL language, the first input must be loaded before the function call. The second input is the operand of the function.

3.7.13.5 ST Language

Q := ROR (IN, NBR);

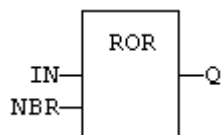
3.7.13.6 FBD Language**3.7.13.7 FFLD Language**

(* The rotation is executed only if EN is TRUE *)

(* ENO has the same value as EN *)

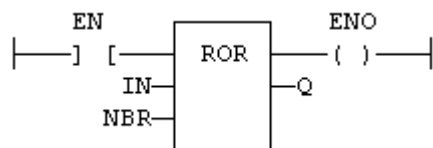
**3.7.13.8 IL Language:**

Op1: LD IN

ROR NBR

ST Q

See also

[SHL](#) [SHR](#) [ROL](#)

3.7.14 RORb / ROR_SINT / ROR_USINT / ROR_BYTE

Function - Rotate bits of a register to the right.

3.7.14.1 Inputs

IN : SINT 8 bit register
 NBR : SINT Number of rotations (each rotation is 1 bit)

3.7.14.2 Outputs

Q : SINT Rotated register

3.7.14.3 Diagram



3.7.14.4 Remarks

In FFLD language, the input rung (EN) enables the operation, and the output rung keeps the state of the input rung. In IL language, the first input must be loaded before the function call. The second input is the operand of the function.

3.7.14.5 ST Language

Q := RORb (IN, NBR);

3.7.14.6 FBD Language

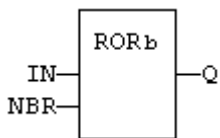

3.7.14.7 FFLD Language

(* The rotation is executed only if EN is TRUE *)

(* ENO has the same value as EN *)

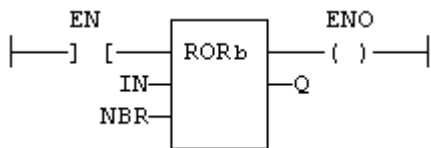

3.7.14.8 IL Language:

Op1: FFLD IN
 RORb NBR
 ST Q

3.7.14.9 See also

[SHL](#) [SHR](#) [ROL](#) [ROR](#) [SHLb](#) [SHRb](#) [ROLb](#) [SHLw](#) [SHRw](#) [ROLw](#) [RORw](#)

3.7.15 RORw / ROR_INT / ROR_UINT / ROR_WORD

Function - Rotate bits of a register to the right.

3.7.15.1 Inputs

IN : INT 16 bit register

NBR : INT Number of rotations (each rotation is 1 bit)

3.7.15.2 Outputs

Q : INT Rotated register

3.7.15.3 Diagram

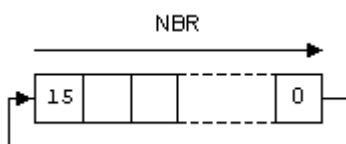

3.7.15.4 Remarks

In FFLD language, the input rung (EN) enables the operation, and the output rung keeps the state of the input rung. In IL language, the first input must be loaded before the function call. The second input is the operand of the function.

3.7.15.5 ST Language

Q := RORw (IN, NBR);

3.7.15.6 FBD Language

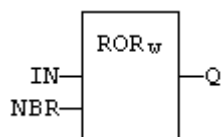

3.7.15.7 FFLD Language

(* The rotation is executed only if EN is TRUE *)

(* ENO has the same value as EN *)

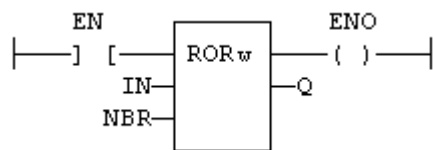

3.7.15.8 IL Language:

Op1: FFLD IN

RORw NBR

ST Q

3.7.15.9 See also

SHL SHR ROL ROR SHLb SHRb ROLb RORb SHLw SHRw ROLw

3.7.16 SETBIT PLCopen

Function - Set a bit in an integer register.

3.7.16.1 Inputs

IN : ANY 8 to 32 bit integer register
 BIT : DINT Bit number (0 = less significant bit)
 VAL : BOOL Bit value to apply

3.7.16.2 Outputs

Q : ANY Modified register

3.7.16.3 Remarks

Types LINT, REAL, LREAL, TIME and STRING are not supported for IN and Q. IN and Q must have the same type. In case of invalid arguments (bad bit number or invalid input type) the function returns the value of IN without modification.

In FFLD language, the operation is executed only if the input rung (EN) is TRUE. The output rung (ENO) keeps the same value as the input rung.

3.7.16.4 ST Language

Q := SETBIT (IN, BIT, VAL);

3.7.16.5 FBD Language

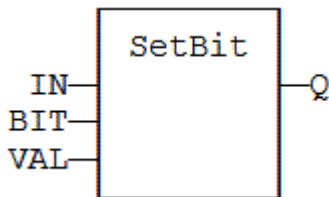

3.7.16.6 FFLD Language

(* The function is executed only if EN is TRUE *)
 (* ENO keeps the same value as EN *)

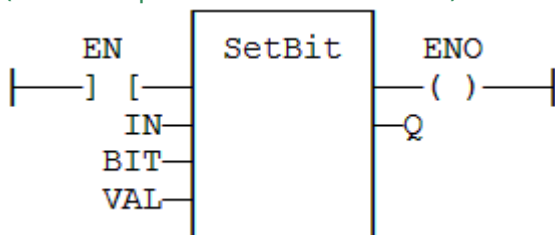

3.7.16.7 IL Language

Not available

See also

[TESTBIT](#)

3.7.17 SHL PLCopen 

Function - Shift bits of a register to the left.

3.7.17.1 Inputs

IN : ANY register

NBS : ANY Number of shifts (each shift is 1 bit)

3.7.17.2 Outputs

Q : ANY Shifted register

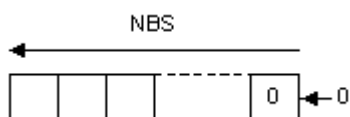
3.7.17.3 Diagram**3.7.17.4 Remarks**

Arguments can be signed or unsigned integers from 8 to 32 bits.

In FLD language, the input rung (EN) enables the operation, and the output rung keeps the state of the input rung. In IL language, the first input must be loaded before the function call. The second input is the operand of the function.

3.7.17.5 ST Language

Q := SHL (IN, NBS);

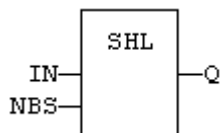
3.7.17.6 FBD Language**3.7.17.7 FFLD Language**

(* The shift is executed only if EN is TRUE *)

(* ENO has the same value as EN *)

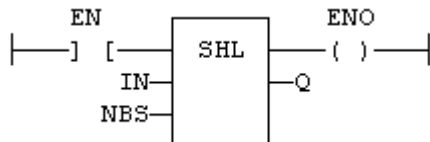
**3.7.17.8 IL Language:**

Op1: LD IN

SHL NBS

ST Q

See also

[SHR](#) [ROL](#) [ROR](#)

3.7.18 SHR PLCopen

Function - Shift bits of a register to the right.

3.7.18.1 Inputs

IN : ANY register
 NBS : ANY Number of shifts (each shift is 1 bit)

3.7.18.2 Outputs

Q : ANY Shifted register

3.7.18.3 Diagram

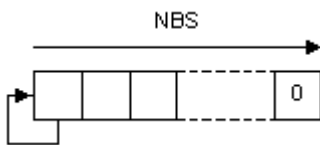

3.7.18.4 Remarks

Arguments can be signed or unsigned integers from 8 to 32 bits.

In FFLD language, the input rung (EN) enables the operation, and the output rung keeps the state of the input rung. In IL language, the first input must be loaded before the function call. The second input is the operand of the function.

3.7.18.5 ST Language

Q := SHR(IN, NBS);

3.7.18.6 FBD Language

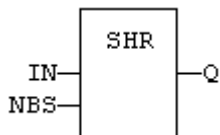

3.7.18.7 FFLD Language

(* The shift is executed only if EN is TRUE *)
 (* ENO has the same value as EN *)

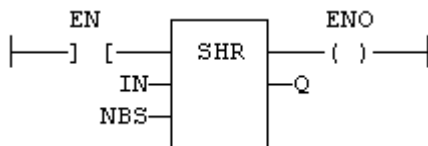

3.7.18.8 IL Language:

```
Op1: LD IN
     SHR NBS
     ST Q
```

See also

[SHL](#) [ROL](#) [ROR](#)

3.7.19 TESTBIT PLCopen 

Function - Test a bit of an integer register.

3.7.19.1 Inputs

IN : ANY 8 to 32 bit integer register
 BIT : DINT Bit number (0 = less significant bit)

3.7.19.2 Outputs

Q : BOOL Bit value

3.7.19.3 Remarks

Types LINT, REAL, LREAL, TIME and STRING are not supported for IN and Q. IN and Q must have the same type. In case of invalid arguments (bad bit number or invalid input type) the function returns FALSE.

In FFD language, the operation is executed only if the input rung (EN) is TRUE. The output rung is the output of the function.

3.7.19.4 ST Language

Q := TESTBIT (IN, BIT);

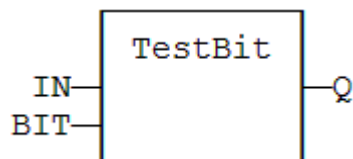
3.7.19.5 FBD Language**3.7.19.6 FFD Language**

(* The function is executed only if EN is TRUE *)

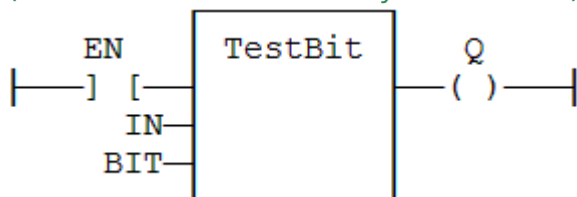
**3.7.19.7 IL Language**

Not available

See also

[SETBIT](#)

3.7.20 UNPACK8 PLCopen

Function block - Extract bits of a byte

3.7.20.1 Inputs

IN : USINT 8 bit register

3.7.20.2 Outputs

Q0 : BOOL Less significant bit

...

Q7 : BOOL Most significant bit

3.7.20.3 Remarks

In FFLD language, the output rung is the Q0 output. The operation is executed only in the input rung (EN) is TRUE.

3.7.20.4 ST Language

(* MyUnpack is a declared instance of the UNPACK8 function block *)

```
MyUnpack (IN);
Q0 := MyUnpack.Q0;
Q1 := MyUnpack.Q1;
Q2 := MyUnpack.Q2;
Q3 := MyUnpack.Q3;
Q4 := MyUnpack.Q4;
Q5 := MyUnpack.Q5;
Q6 := MyUnpack.Q6;
Q7 := MyUnpack.Q7;
```

3.7.20.5 FBD Language

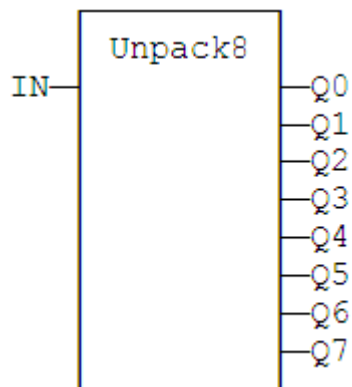

3.7.20.6 FFLD Language

(* The operation is performed if EN = TRUE *)

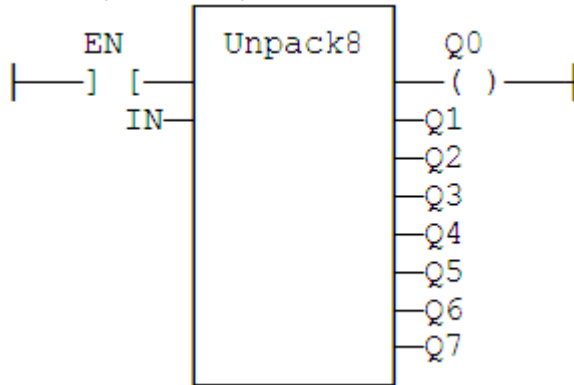

3.7.20.7 IL Language:

(* MyUnpack is a declared instance of the UNPACK8 function block *)

Op1: CAL MyUnpack (IN)

FFLD MyUnpack.Q0

ST Q0

(* ... *)

FFLD MyUnpack.Q7

ST Q7

See also

[PACK8](#)

3.7.21 XOR_MASK PLCopen

Function - Performs a bit to bit exclusive OR between two integer values

3.7.21.1 Inputs

IN : ANY First input
 MSK : ANY Second input (XOR mask)

3.7.21.2 Outputs

Q : ANY Exclusive OR mask between IN and MSK inputs

3.7.21.3 Remarks

Arguments can be signed or unsigned integers from 8 to 32 bits.

In FFLD language, the input rung (EN) enables the operation, and the output rung keeps the same value as the input rung. In IL language, the first parameter (IN) must be loaded in the current result before calling the function. The other input is the operands of the function.

3.7.21.4 ST Language

Q := XOR_MASK (IN, MSK);

3.7.21.5 FBD Language

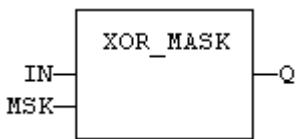

3.7.21.6 FFLD Language

(* The function is executed only if EN is TRUE *)
 (* ENO is equal to EN *)

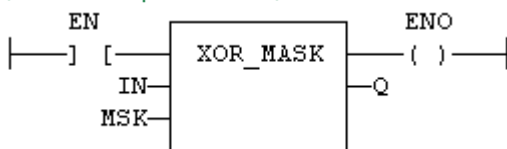

3.7.21.7 IL Language:

Op1: LD IN
 XOR_MASK MSK
 ST Q

See also

[AND_MASK](#) [OR_MASK](#) [NOT_MASK](#)

3.8 Counters

Below are the standard blocks for managing counters:

CTU	Up counter
CTD	Down Counter
CTUD	Up / Down Counter

3.8.1 CTD / CTDr PLCopen

Function Block - Down counter.

3.8.1.1 Inputs

CD : BOOL Enable counting. Counter is decreased on each call when CD is TRUE
 LOAD : BOOL Re-load command. Counter is set to PV when called with LOAD to TRUE
 PV : DINT Programmed maximum value

3.8.1.2 Outputs

Q : BOOL TRUE when counter is empty, i.e. when CV = 0
 CV : DINT Current value of the counter

3.8.1.3 Remarks

The counter is empty (CV = 0) when the application starts. The counter does not include a pulse detection for CD input. Use R_TRIG or F_TRIG function block for counting pulses of CD input signal. In FFLD language, CD is the input rung. The output rung is the Q output.

CTUr, CTDr, CTUDr function blocks operate exactly as other counters, except that all Boolean inputs (CU, CD, RESET, LOAD) have an implicit rising edge detection included.

3.8.1.4 ST Language

(* MyCounter is a declared instance of CTD function block *)

```
MyCounter (CD, LOAD, PV);
Q := MyCounter.Q;
CV := MyCounter.CV;
```

3.8.1.5 FBD Language

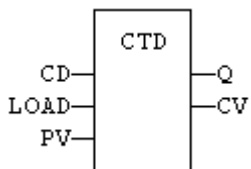

3.8.1.6 FFLD Language

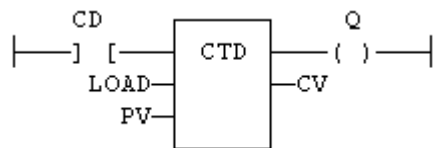

3.8.1.7 IL Language:

(* MyCounter is a declared instance of CTD function block *)

```
Op1: CAL MyCounter (CD, LOAD, PV)
FFLD MyCounter.Q
ST Q
FFLD MyCounter.CV
ST CV
```

See also

[CTU](#) [CTUD](#)

3.8.2 CTU / CTUr PLCopen

Function Block - Up counter.

3.8.2.1 Inputs

CU : BOOL Enable counting. Counter is increased on each call when CU is TRUE
 RESET : BOOL Reset command. Counter is reset to 0 when called with RESET to TRUE
 PV : DINT Programmed maximum value

3.8.2.2 Outputs

Q : BOOL TRUE when counter is full, i.e. when CV = PV
 CV : DINT Current value of the counter

3.8.2.3 Remarks

The counter is empty (CV = 0) when the application starts. The counter does not include a pulse detection for CU input. Use R_TRIG or F_TRIG function block for counting pulses of CU input signal. In FFLD language, CU is the input rung. The output rung is the Q output.

CTUr, CTDr, CTUDr function blocks operate exactly as other counters, except that all Boolean inputs (CU, CD, RESET, LOAD) have an implicit rising edge detection included.

3.8.2.4 ST Language

(* MyCounter is a declared instance of CTU function block *)

MyCounter (CU, RESET, PV);

Q := MyCounter.Q;

CV := MyCounter.CV;

3.8.2.5 FBD Language

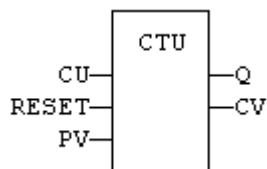

3.8.2.6 FFLD Language

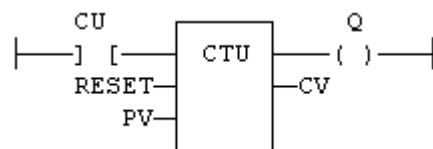

3.8.2.7 IL Language:

(* MyCounter is a declared instance of CTU function block *)

Op1: CAL MyCounter (CU, RESET, PV)

FFLD MyCounter.Q

ST Q

FFLD MyCounter.CV

ST CV

See also

[CTD](#) [CTUD](#)

3.8.3 CTUD / CTUDr PLCopen

Function Block - Up/down counter.

3.8.3.1 Inputs

CU : BOOL Enable counting. Counter is increased on each call when CU is TRUE
 CD : BOOL Enable counting. Counter is decreased on each call when CD is TRUE
 RESET : BOOL Reset command. Counter is reset to 0 called with RESET to TRUE
 LOAD : BOOL Re-load command. Counter is set to PV when called with LOAD to TRUE
 PV : DINT Programmed maximum value

3.8.3.2 Outputs

QU : BOOL TRUE when counter is full, i.e. when CV = PV
 QD : BOOL TRUE when counter is empty, i.e. when CV = 0
 CV : DINT Current value of the counter

3.8.3.3 Remarks

- The counter is empty (CV = 0) when the application starts. The counter does not include a pulse detection for CU and CD inputs. Use R_TRIG or F_TRIG function blocks for counting pulses of CU or CD input signals. In FFLD language, CU is the input rung. The output rung is the QU output.
- CTUr, CTDr, CTUDr function blocks operate exactly as other counters, except that all Boolean inputs (CU, CD, RESET, LOAD) have an implicit rising edge detection included.

3.8.3.4 ST Language

```
(* MyCounter is a declared instance of CTUD function block *)
MyCounter (CU, CD, RESET, LOAD, PV);
QU := MyCounter.QU;
QD := MyCounter.QD;
CV := MyCounter.CV;
```

3.8.3.5 FBD Language

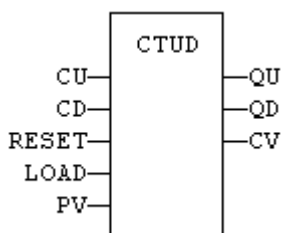

3.8.3.6 FFLD Language

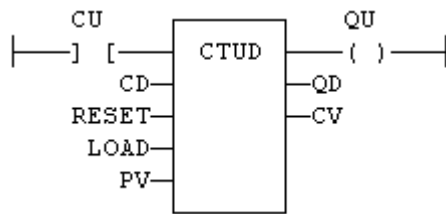

3.8.3.7 IL Language:

```
(* MyCounter is a declared instance of CTUD function block *)
Op1: CAL      MyCounter (CU, CD, RESET, LOAD, PV)
FFLD        MyCounter.QU
ST          QU
FFLD        MyCounter.QD
ST          QD
FFLD        MyCounter.CV
ST          CV
```

See also

[CTU](#) [CTD](#)

3.9 Timers

Below are the standard functions for managing timers:

TON	On timer
TOF	Off timer
TP	Pulse timer
BLINK	Blinker
BLINKA	Asymmetric blinker
PLS	Pulse signal generator
TMU	Up-counting stop watch
TMUsec	Up-counting stop watch (seconds)
TMD	Down-counting stop watch

3.9.1 BLINK PLCopen

Function Block - Blinker.

3.9.1.1 Inputs

RUN : BOOL Enabling command
CYCLE : TIME Blinking period

3.9.1.2 Outputs

Q : BOOL Output blinking signal

3.9.1.3 Time diagram

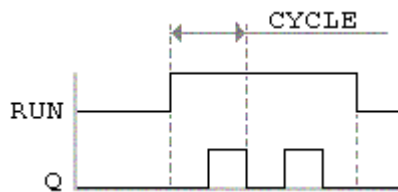

3.9.1.4 Remarks

The output signal is FALSE when the RUN input is FALSE. The CYCLE input is the complete period of the blinking signal. In FFLD language, the input rung is the IN command. The output rung is the Q output signal.

3.9.1.5 ST Language

(* MyBlinker is a declared instance of BLINK function block *)
MyBlinker (RUN, CYCLE);
Q := MyBlinker.Q;

3.9.1.6 FBD Language

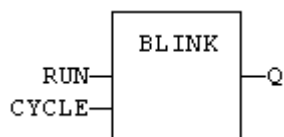

3.9.1.7 FFLD Language

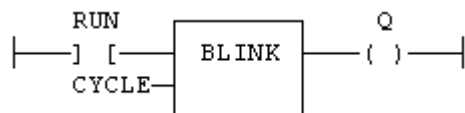

3.9.1.8 IL Language

(* MyBlinker is a declared instance of BLINK function block *)
Op1: CAL MyBlinker (RUN, CYCLE)
FFLD MyBlinker.Q
ST Q

See also

[TON](#) [TOF](#) [TP](#)

3.9.2 BLINKA PLCopen

Function Block - Asymmetric blinker.

3.9.2.1 Inputs

- RUN : BOOL Enabling command
- TM0 : TIME Duration of FALSE state on output
- TM1 : TIME Duration of TRUE state on output

3.9.2.2 Outputs

- Q : BOOL Output blinking signal

3.9.2.3 Time diagram

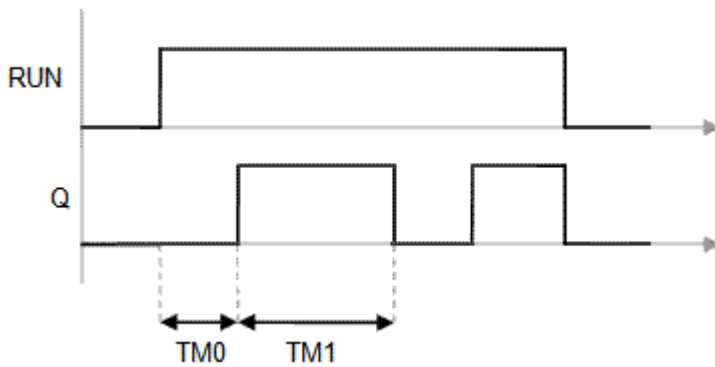

3.9.2.4 Remarks

The output signal is FALSE when the RUN input is FALSE. In FFLD language, the input rung is the IN command. The output rung is the Q output signal.

3.9.2.5 ST Language

```
(* MyBlinker is a declared instance of BLINKA function block *)
MyBlinker (RUN, TM0, TM1);
Q := MyBlinker.Q;
```

3.9.2.6 FBD Language

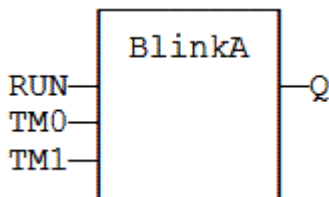

3.9.2.7 FFLD Language

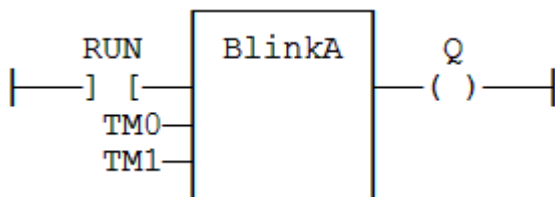

3.9.2.8 IL Language:

(* MyBlinker is a declared instance of BLINKA function block *)

Op1: CAL MyBlinker (RUN, TM0, TM1)

FFLD MyBlinker.Q

ST Q

See also

[TON](#) [TOF](#) [TP](#)

3.9.3 PLS PLCopen

Function Block - Pulse signal generator

3.9.3.1 Inputs

RUN : BOOL Enabling command
 CYCLE : TIME Signal period

3.9.3.2 Outputs

Q : BOOL Output pulse signal

3.9.3.3 Time diagram

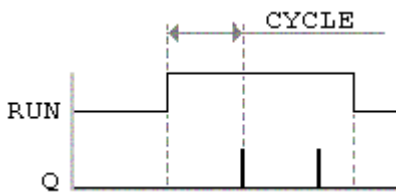

3.9.3.4 Remarks

On every period, the output is set to TRUE during one cycle only. In FFLD language, the input rung is the IN command. The output rung is the Q output signal.

3.9.3.5 ST Language

```
(* MyPLS is a declared instance of PLS function block *)
MyPLS (RUN, CYCLE);
Q := MyPLS.Q;
```

3.9.3.6 FBD Language

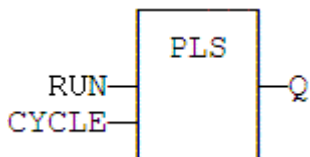

3.9.3.7 FFLD Language

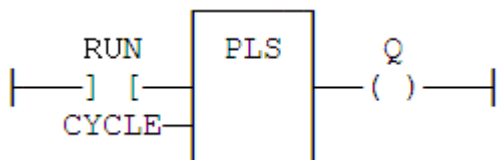

3.9.3.8 IL Language

```
(* MyPLS is a declared instance of PLS function block *)  
Op1: CAL MyPLS (RUN, CYCLE)  
      FFLD MyPLS.Q  
      ST  Q
```

See also

[TON TOF TP](#)

3.9.4 Sig_Gen PLCopen ✓

Function Block - Generator of pseudo-analogical Signal

3.9.4.1 Inputs

RUN : BOOL Enabling command

PERIOD : TIME Signal period

MAXIMUM : DINT Maximum growth during the signal period

3.9.4.2 Outputs

This FB generates signals of the four following types:

- PULSE: blinking at each period
- UP : growing according max * period
- END : pulse after max * period
- SINE : sine curve

3.9.4.3 FFLD Language

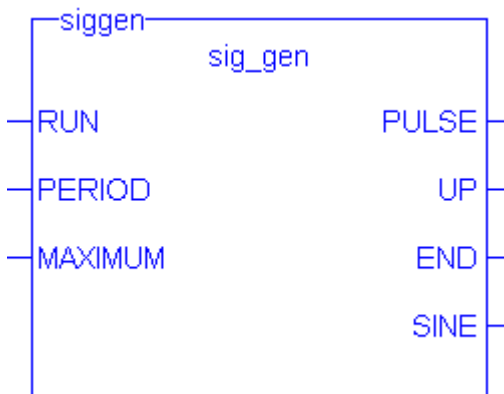

3.9.5 TMD PLCopen

Function Block - Down-counting stop watch.

3.9.5.1 Inputs

IN : BOOL The time counts when this input is TRUE
 RST : BOOL Timer is reset to PT when this input is TRUE
 PT : TIME Programmed time

3.9.5.2 Outputs

Q : BOOL Timer elapsed output signal
 ET : TIME Elapsed time

3.9.5.3 Time diagram

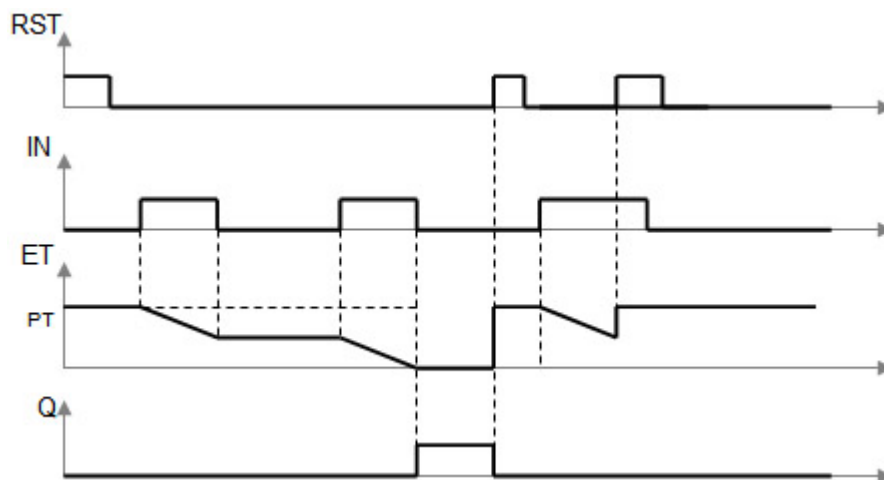

3.9.5.4 Remarks

The timer counts up when the IN input is TRUE. It stops when the programmed time is elapsed. The timer is reset when the RST input is TRUE. It is not reset when IN is false.

3.9.5.5 ST Language

(* MyTimer is a declared instance of TMD function block *)

MyTimer (IN, RST, PT);

Q := MyTimer.Q;

ET := MyTimer.ET;

3.9.5.6 FBD Language

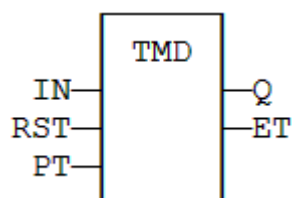

3.9.5.7 FFLD Language

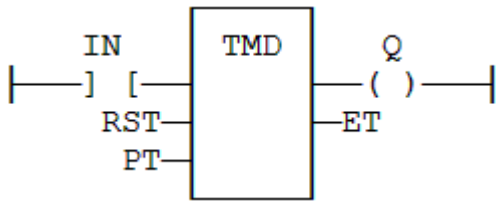

3.9.5.8 IL Language

(* MyTimer is a declared instance of TMD function block *)

Op1: CAL MyTimer (IN, RST, PT)

FFLD: MyTimer.Q

ST: Q

FFLD: MyTimer.ET

ST: ET

See also

[TMU](#)

3.9.6 TMU / TMUsec PLCopen

Function Block - Up-counting stop watch. TMUsec is identical to TMU except that the parameter is a number of seconds.

3.9.6.1 Inputs

IN	BOOL	The time counts when this input is TRUE
RST	BOOL	Timer is reset to 0 when this input is TRUE
PT	TIME	Programmed time
PTsec	UDINT	Programmed time. (TMUsec - seconds)

3.9.6.2 Outputs

Q : BOOL Timer elapsed output signal
ET : TIME Elapsed time

Q	BOOL	Timer elapsed output signal
ET	TIME	Elapsed time
ETsec	UDINT	Elapsed time. (TMU - seconds)

3.9.6.3 Time diagram

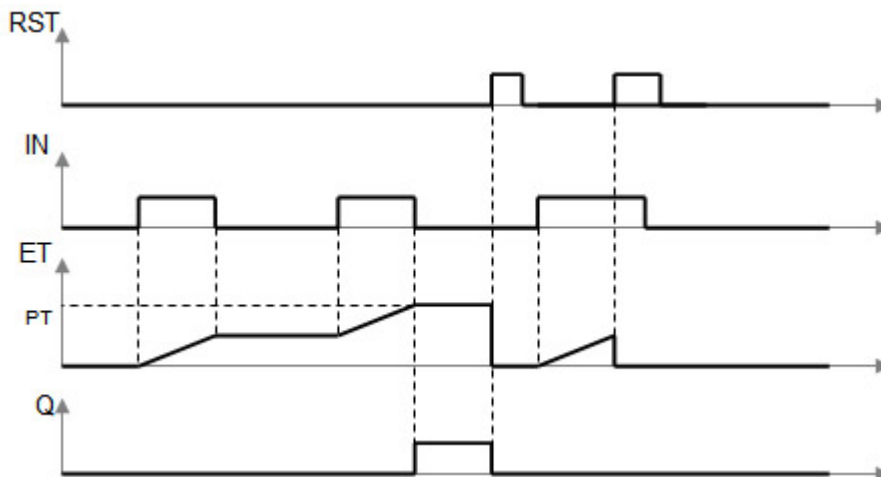

3.9.6.4 Remarks

The timer counts up when the IN input is TRUE. It stops when the programmed time is elapsed. The timer is reset when the RST input is TRUE. It is not reset when IN is false.

3.9.6.5 ST Language

(* MyTimer is a declared instance of TMU function block *)

```
MyTimer (IN, RST, PT);
Q := MyTimer.Q;
ET := MyTimer.ET;
```

3.9.6.6 FBD Language

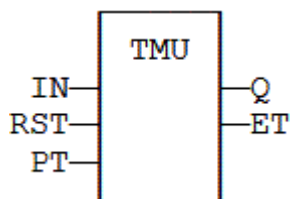

3.9.6.7 FFLD Language

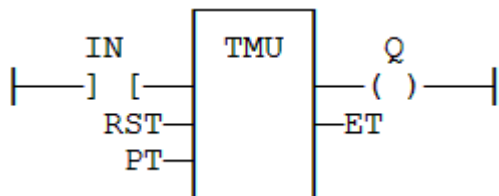

3.9.6.8 IL Language:

(* MyTimer is a declared instance of TMU function block *)

```
Op1: CAL    MyTimer (IN, RST, PT)
      FFLD  MyTimer.Q
      ST    Q
      FFLD  MyTimer.ET
      ST    ET
```

See also

[TMD](#)

3.9.7 TOF / TOFR PLCopen

Function Block - Off timer.

3.9.7.1 Inputs

IN : BOOL Timer command
 PT : TIME Programmed time
 RST : BOOL Reset (TOFR only)

3.9.7.2 Outputs

Q : BOOL Timer elapsed output signal
 ET : TIME Elapsed time

3.9.7.3 Time diagram

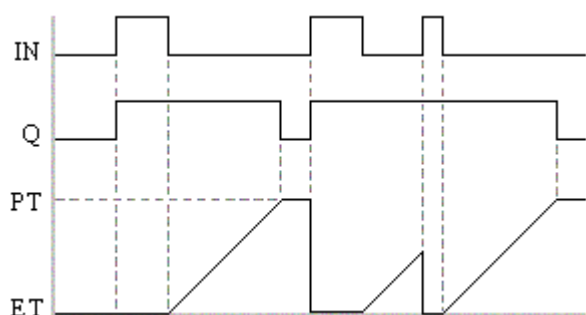

3.9.7.4 Remarks

The timer starts on a falling pulse of IN input. It stops when the elapsed time is equal to the programmed time. A rising pulse of IN input resets the timer to 0. The output signal is set to TRUE on when the IN input rises to TRUE, reset to FALSE when programmed time is elapsed..

TOFR is same as TOF but has an extra input for resetting the timer

In FFLD language, the input rung is the IN command. The output rung is Q the output signal.

3.9.7.5 ST Language

(* MyTimer is a declared instance of TOF function block *)

MyTimer (IN, PT);

Q := MyTimer.Q;

ET := MyTimer.ET;

3.9.7.6 FBD Language

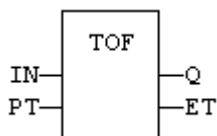

3.9.7.7 FFLD Language

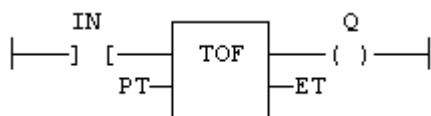

3.9.7.8 IL Language:

(* MyTimer is a declared instance of TOF function block *)

Op1: CAL MyTimer (IN, PT)

FFLD MyTimer.Q

ST Q

FFLD MyTimer.ET

ST ET

See also

[TON](#) [TP](#) [BLINK](#)

3.9.8 TON PLCopen 

Function Block - On timer.

3.9.8.1 Inputs

IN : BOOL Timer command
PT : TIME Programmed time

3.9.8.2 Outputs

Q : BOOL Timer elapsed output signal
ET : TIME Elapsed time

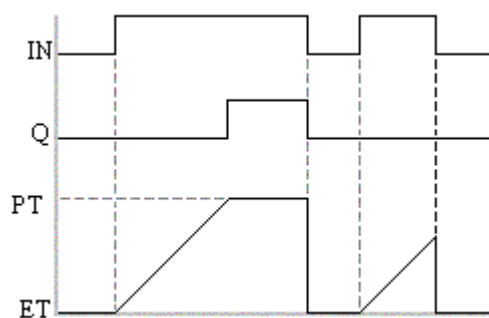
3.9.8.3 Time diagram**3.9.8.4 Remarks**

- The timer starts on a rising pulse of IN input. It stops when the elapsed time is equal to the programmed time. A falling pulse of IN input resets the timer to 0. The output signal is set to TRUE when programmed time is elapsed, and reset to FALSE when the input command falls.
- In FFLD language, the input rung is the IN command. The output rung is Q the output signal.

3.9.8.5 ST Language

```
(* Inst_TON is a declared instance of TON function block *)
Inst_TON( FALSE, T#2s );
Q := Inst_TON.Q;
ET := Inst_TON.ET;
```

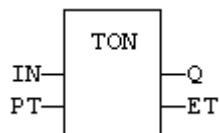
3.9.8.6 FBD Language

3.9.8.7 FFLD Language

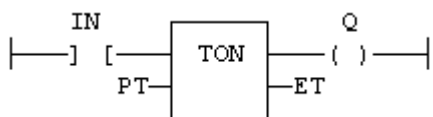

3.9.8.8 IL Language:

```
(* MyTimer is a declared instance of TON function block *)
Op1: CAL MyTimer (IN, PT)
      FFLD MyTimer.Q
      ST Q
      FFLD MyTimer.ET
      ST ET
```

See also

[TOF](#) [TP](#) [BLINK](#)

3.9.9 TP / TPR PLCopen

Function Block - Pulse timer.

3.9.9.1 Inputs

IN : BOOL Timer command
 PT : TIME Programmed time
 RST : BOOL Reset (TPR only)

3.9.9.2 Outputs

Q : BOOL Timer elapsed output signal
 ET : TIME Elapsed time

3.9.9.3 Time diagram

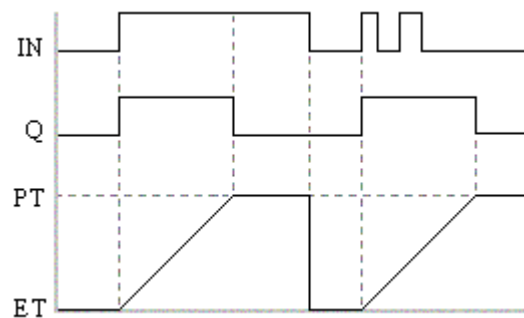

3.9.9.4 Remarks

The timer starts on a rising pulse of IN input. It stops when the elapsed time is equal to the programmed time. A falling pulse of IN input resets the timer to 0, only if the programmed time is elapsed. All pulses of IN while the timer is running are ignored. The output signal is set to TRUE while the timer is running.

TPR is same as TP but has an extra input for resetting the timer

In FFLD language, the input rung is the IN command. The output rung is Q the output signal.

3.9.9.5 ST Language

(* MyTimer is a declared instance of TP function block *)

```
MyTimer (IN, PT);
Q := MyTimer.Q;
ET := MyTimer.ET;
```

3.9.9.6 FBD Language

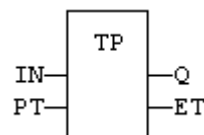

3.9.9.7 FFLD Language

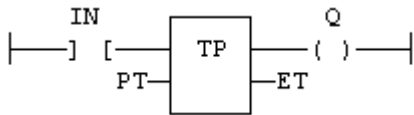

3.9.9.8 IL Language:

(* MyTimer is a declared instance of TP function block *)

```
Op1: CAL MyTimer (IN, PT)
      FFLD MyTimer.Q
      ST Q
      FFLD MyTimer.ET
      ST ET
```

See also

[TON](#) [TOF](#) [BLINK](#)

3.10 Mathematic operations PLCopen

Below are the standard functions that perform mathematic calculation:

ABS	absolute value
TRUNC	integer part
LOG, LN / LNL	logarithm, natural logarithm
POW, EXPT, EXP / EXPL	power
SQRT, ROOT	square root, root extraction
SCALELIN	scaling - linear conversion

3.10.1 ABS / ABSL PLCopen

Function - Returns the absolute value of the input.

3.10.1.1 Inputs

IN : REAL/LREAL ANY value

3.10.1.2 Outputs

Q : REAL/LREAL Result: absolute value of IN

3.10.1.3 Remarks

In FFLD language, the operation is executed only if the input rung (EN) is TRUE. The output rung (ENO) keeps the same value as the input rung. In IL, the input must be loaded in the current result before calling the function.

3.10.1.4 ST Language

Q := ABS (IN);

3.10.1.5 FBD Language

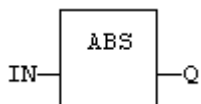

3.10.1.6 FFLD Language

The function is executed only if EN is TRUE. ENO keeps the same value as EN.

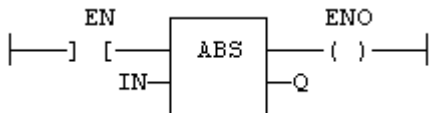

3.10.1.7 IL Language

Op1: LD IN
 ABS
 ST Q (* Q is: ABS(IN) *)

See also

[TRUNC](#) [LOG](#) [POW](#) [SQRT](#)

3.10.2 EXPT PLCopen

Function - Calculates a power.

3.10.2.1 Inputs

IN : REAL Real value
EXP : DINT Exponent

3.10.2.2 Outputs

Q : REAL Result: IN at the 'EXP' power

3.10.2.3 Remarks

In FFLD language, the operation is executed only if the input rung (EN) is TRUE. The output rung (ENO) keeps the same value as the input rung.

In IL, the input must be loaded in the current result before calling the function. The exponent (second input of the function) must be the operand of the function.

3.10.2.4 ST Language

Q := EXPT (IN, EXP);

3.10.2.5 FBD Language

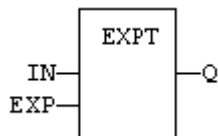

3.10.2.6 FFLD Language

(* The function is executed only if EN is TRUE *)
(* ENO keeps the same value as EN *)

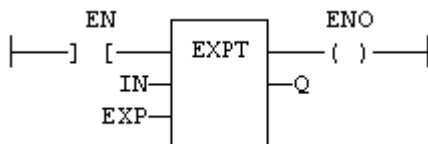

3.10.2.7 IL Language:

Op1: LD IN
EXPT EXP
ST Q (* Q is: (IN ** EXP) *)

See also

[ABS](#) [TRUNC](#) [LOG](#) [SQRT](#)

3.10.3 EXP / EXPL PLCopen

Function - Calculates the natural exponential of the input.

3.10.3.1 Inputs

IN : REAL/LREAL Real value

3.10.3.2 Outputs

Q : REAL/LREAL Result: natural exponential of IN.

3.10.3.3 Remarks

In FFLD language, the operation is executed only if the input rung (EN) is TRUE. The output rung (ENO) keeps the same value as the input rung.

In IL, the input must be loaded in the current result before calling the function.

3.10.3.4 ST Language

```
Q := EXP (IN);
```

3.10.3.5 FBD Language

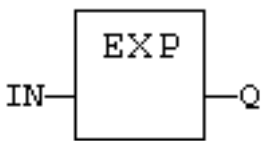

3.10.3.6 FFLD Language

(* The function is executed only if EN is TRUE *)
 (* ENO keeps the same value as EN *)

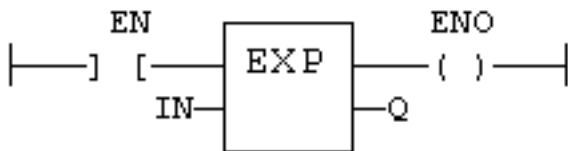

3.10.3.7 IL Language:

```
Op1: LD  IN
      EXP
      ST  Q      (* Q is: EXP (IN) *)
```

3.10.4 LOG / LOGL PLCopen 

Function - Calculates the logarithm (base 10) of the input.

3.10.4.1 Inputs

IN : REAL/LREAL Real value

3.10.4.2 Outputs

Q : REAL/LREAL Result: logarithm (base 10) of IN

3.10.4.3 Remarks

In FFLD language, the operation is executed only if the input rung (EN) is TRUE. The output rung (ENO) keeps the same value as the input rung.

In IL, the input must be loaded in the current result before calling the function.

3.10.4.4 ST Language

```
Q := LOG (IN);
```

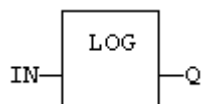
3.10.4.5 FBD Language**3.10.4.6 FFLD Language**

(* The function is executed only if EN is TRUE *)

(* ENO keeps the same value as EN *)

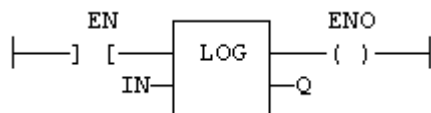
**3.10.4.7 IL Language:**

Op1: LD IN

LOG

ST Q (* Q is: LOG (IN) *)

See also

[ABS](#) [TRUNC](#) [POW](#) [SQRT](#)

3.10.5 LN / LNL PLCopen

Function - Calculates the natural logarithm of the input.

3.10.5.1 Inputs

IN : REAL/LREAL Real value

3.10.5.2 Outputs

Q : REAL/LREAL Result: natural logarithm of IN

3.10.5.3 Remarks

In FFLD language, the operation is executed only if the input rung (EN) is TRUE. The output rung (ENO) keeps the same value as the input rung.

In IL, the input must be loaded in the current result before calling the function.

3.10.5.4 ST Language

```
Q := LN (IN);
```

3.10.5.5 FBD Language

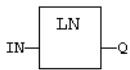

3.10.5.6 FFLD Language

(* The function is executed only if EN is TRUE *)

(* ENO keeps the same value as EN *)

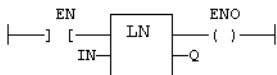

3.10.5.7 IL Language:

```
Op1: LD IN
      LN
      ST Q (* Q is: LN (IN) *)
```

3.10.6 POW ** POWL PLCopen

Function - Calculates a power.

3.10.6.1 Inputs

IN : REAL/LREAL Real value
EXP : REAL/LREAL Exponent

3.10.6.2 Outputs

Q : REAL/LREAL Result: IN at the 'EXP' power

3.10.6.3 Remarks

Alternatively, in ST language, the "***" operator can be used. In FFLD language, the operation is executed only if the input rung (EN) is TRUE. The output rung (ENO) keeps the same value as the input rung.

In IL, the input must be loaded in the current result before calling the function. The exponent (second input of the function) must be the operand of the function.

3.10.6.4 ST Language

Q := POW (IN, EXP);
Q := IN ** EXP;

3.10.6.5 FBD Language

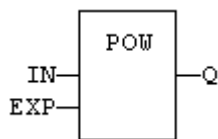

3.10.6.6 FFLD Language

(* The function is executed only if EN is TRUE *)
(* ENO keeps the same value as EN *)

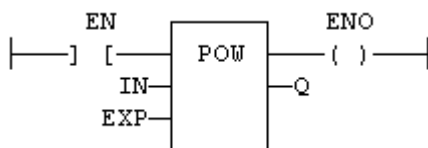

3.10.6.7 IL Language:

Op1: LD IN
 POW EXP
 ST Q (* Q is: (IN ** EXP) *)

See also

[ABS](#) [TRUNC](#) [LOG](#) [SQRT](#)

3.10.7 ROOT PLCopen

Function - Calculates the Nth root of the input.

3.10.7.1 Inputs

IN : REAL Real value
 N : DINT Root level

3.10.7.2 Outputs

Q : REAL Result: Nth root of IN

3.10.7.3 Remarks

In FFLD language, the operation is executed only if the input rung (EN) is TRUE. The output rung (ENO) keeps the same value as the input rung.

In IL, the input must be loaded in the current result before calling the function.

3.10.7.4 ST Language

```
Q := ROOT (IN, N);
```

3.10.7.5 FBD Language

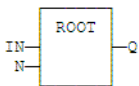

3.10.7.6 FFLD Language

(* The function is executed only if EN is TRUE *)
 (* ENO keeps the same value as EN *)

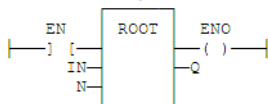

3.10.7.7 IL Language:

```
Op1: LD IN
      ROOT N
      ST Q (* Q is: ROOT (IN) *)
```

3.10.8 ScaleLin PLCopen

Function - Scaling - linear conversion.

3.10.8.1 Inputs

IN : REAL Real value
 IMIN : REAL Minimum input value
 IMAX : REAL Maximum input value
 OMIN : REAL Minimum output value
 OMAX : REAL Maximum output value

3.10.8.2 Outputs

OUT : REAL Result: $OMIN + IN * (OMAX - OMIN) / (IMAX - IMIN)$

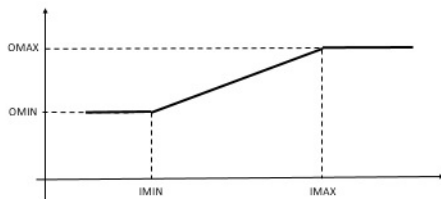

3.10.8.3 Truth table

Inputs	OUT
$IMIN \geq IMAX$	$= IN$
$IN < IMIN$	$= IMIN$
$IN > IMAX$	$= IMAX$
other	$= OMIN + IN * (OMAX - OMIN) / (IMAX - IMIN)$

3.10.8.4 Remarks

- In FFLD language, the operation is executed only if the input rung (EN) is TRUE. The output rung (ENO) keeps the same value as the input rung.
- In IL, the input must be loaded in the current result before calling the function.

3.10.8.5 ST Language

```
OUT := ScaleLin (IN, IMIN, IMAX, OMIN, OMAX);
```

3.10.8.6 FBD Language

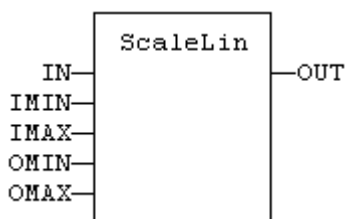

3.10.8.7 FFLD Language

```
(* The function is executed only if EN is TRUE *)
(* ENO keeps the same value as EN *)
```

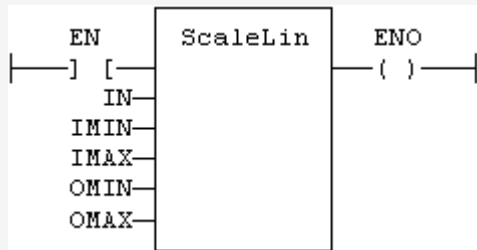

3.10.8.8 IL Language

```
Op1: LD IN
ScaleLin IMAX, IMIN, OMAX, OMIN
ST OUT
```

3.10.9 SQRT / SQRTL PLCopen

Function - Calculates the square root of the input.

3.10.9.1 Inputs

IN : REAL/LREAL Real value

3.10.9.2 Outputs

Q : REAL/LREAL Result: square root of IN

3.10.9.3 Remarks

In FFLD language, the operation is executed only if the input rung (EN) is TRUE. The output rung (ENO) keeps the same value as the input rung.

In IL, the input must be loaded in the current result before calling the function.

3.10.9.4 ST Language

Q := SQRT (IN);

3.10.9.5 FBD Language

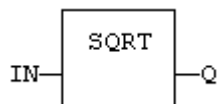

3.10.9.6 FFLD Language

(* The function is executed only if EN is TRUE *)

(* ENO keeps the same value as EN *)

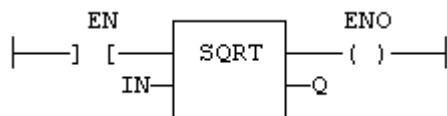

3.10.9.7 IL Language:

Op1: LD IN

 SQRT

 ST Q (* Q is: SQRT (IN) *)

See also

[ABS](#) [TRUNC](#) [LOG](#) [POW](#)

3.10.10 TRUNC / TRUNCL PLCopen

Function - Truncates the decimal part of the input.

3.10.10.1 Inputs

IN : REAL/LREAL Real value

3.10.10.2 Outputs

Q : REAL/LREAL Result: integer part of IN

3.10.10.3 Remarks

In FFLD language, the operation is executed only if the input rung (EN) is TRUE. The output rung (ENO) keeps the same value as the input rung.

In IL, the input must be loaded in the current result before calling the function.

3.10.10.4 ST Language

Q := TRUNC (IN);

3.10.10.5 FBD Language

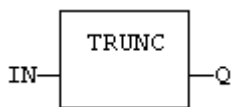

3.10.10.6 FFLD Language

(* The function is executed only if EN is TRUE *)

(* ENO keeps the same value as EN *)

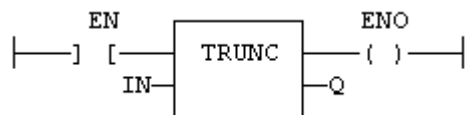

3.10.10.7 IL Language:

Op1: LD IN

TRUNC

ST Q (* Q is the integer part of IN *)

See also

[ABS](#) [LOG](#) [POW](#) [SQRT](#)

3.11 Trigonometric functions

Below are the standard functions for trigonometric calculation:

SIN	sine
COS	cosine
TAN	tangent
ASIN	arc-sine
ACOS	arc-cosine
ATAN	arc-tangent
ATAN2	arc-tangent of Y / X

See Also:

[UseDegrees](#)

3.11.1 ACOS / ACOSL PLCopen

Function - Calculate an arc-cosine.

3.11.1.1 Inputs

IN : REAL/LREAL Real value

3.11.1.2 Outputs

Q : REAL/LREAL Result: arc-cosine of IN

3.11.1.3 Remarks

In FFLD language, the operation is executed only if the input rung (EN) is TRUE. The output rung (ENO) keeps the same value as the input rung.

In IL, the input must be loaded in the current result before calling the function.

3.11.1.4 ST Language

Q := ACOS (IN);

3.11.1.5 FBD Language



3.11.1.6 FFLD Language

(* The function is executed only if EN is TRUE *)

(* ENO keeps the same value as EN *)

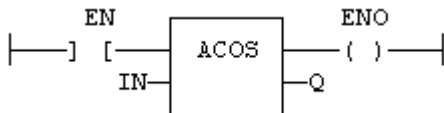

3.11.1.7 IL Language:

Op1: LD IN

ACOS

ST Q (* Q is: ACOS (IN) *)

See also

[SIN](#) [COS](#) [TAN](#) [ASIN](#) [ATAN](#) [ATAN2](#)

3.11.2 ASIN / ASINL PLCopen

Function - Calculate an arc-sine.

3.11.2.1 Inputs

IN : REAL/LREAL Real value

3.11.2.2 Outputs

Q : REAL/LREAL Result: arc-sine of IN

3.11.2.3 Remarks

In FFLD language, the operation is executed only if the input rung (EN) is TRUE. The output rung (ENO) keeps the same value as the input rung.

In IL, the input must be loaded in the current result before calling the function.

3.11.2.4 ST Language

Q := ASIN (IN);

3.11.2.5 FBD Language

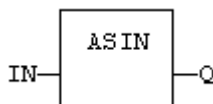

3.11.2.6 FFLD Language

(* The function is executed only if EN is TRUE *)

(* ENO keeps the same value as EN *)

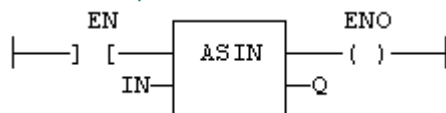

3.11.2.7 IL Language:

Op1: LD IN

ASIN

ST Q (* Q is: ASIN (IN) *)

See also

[SIN](#) [COS](#) [TAN](#) [ACOS](#) [ATAN](#) [ATAN2](#)

3.11.3 ATAN / ATANL PLCopen

Function - Calculate an arc-tangent.

3.11.3.1 Inputs

IN : REAL/LREAL Real value

3.11.3.2 Outputs

Q : REAL/LREAL Result: arc-tangent of IN

3.11.3.3 Remarks

In FFLD language, the operation is executed only if the input rung (EN) is TRUE. The output rung (ENO) keeps the same value as the input rung.

In IL, the input must be loaded in the current result before calling the function.

3.11.3.4 ST Language

Q := ATAN (IN);

3.11.3.5 FBD Language

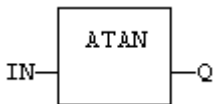

3.11.3.6 FFLD Language

(* The function is executed only if EN is TRUE *)

(* ENO keeps the same value as EN *)

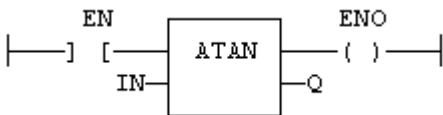

3.11.3.7 IL Language:

Op1: LD IN

ATAN

ST Q (* Q is: ATAN (IN) *)

See also

[SIN](#) [COS](#) [TAN](#) [ASIN](#) [ACOS](#) [ATAN2](#)

3.11.4 ATAN2 / ATAN2L

Function - Calculate arc-tangent of Y/X

3.11.4.1 Inputs

Y : REAL/LREAL Real value

X : REAL/LREAL Real value

3.11.4.2 Outputs

Q : REAL/LREAL Result: arc-tangent of Y / X

3.11.4.3 Remarks

In FFLD language, the operation is executed only if the input rung (EN) is TRUE. The output rung (ENO) keeps the same value as the input rung.

In IL, the input must be loaded in the current result before calling the function.

3.11.4.4 ST Language

Q := ATAN2 (IN);

3.11.4.5 FBD Language

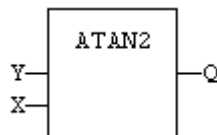

3.11.4.6 FFLD Language

(* The function is executed only if EN is TRUE *)

(* ENO keeps the same value as EN *)

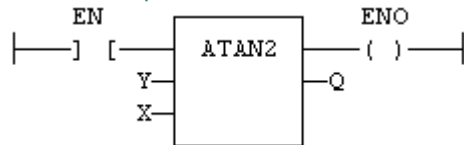

3.11.4.7 IL Language

Op1: LD Y

 ATAN2 X

 ST Q (* Q is: ATAN2 (Y / X) *)

See also

[SIN](#) [COS](#) [TAN](#) [ASIN](#) [ACOS](#) [ATAN](#)

3.11.5 COS / COSL PLCopen

Function - Calculate a cosine.

3.11.5.1 Inputs

IN : REAL/LREAL Real value

3.11.5.2 Outputs

Q : REAL/LREAL Result: cosine of IN

3.11.5.3 Remarks

In FFLD language, the operation is executed only if the input rung (EN) is TRUE. The output rung (ENO) keeps the same value as the input rung.

In IL, the input must be loaded in the current result before calling the function.

3.11.5.4 ST Language

Q := COS (IN);

3.11.5.5 FBD Language

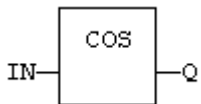

3.11.5.6 FFLD Language

(* The function is executed only if EN is TRUE *)

(* ENO keeps the same value as EN *)

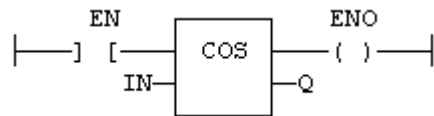

3.11.5.7 IL Language:

Op1: LD IN

COS

ST Q (* Q is: COS (IN) *)

See also

[SIN](#) [TAN](#) [ASIN](#) [ACOS](#) [ATAN](#) [ATAN2](#)

3.11.6 SIN / SINL PLCopen

Function - Calculate a sine.

3.11.6.1 Inputs

IN : REAL/LREAL Real value

3.11.6.2 Outputs

Q : REAL/LREAL Result: sine of IN

3.11.6.3 Remarks

In FFLD language, the operation is executed only if the input rung (EN) is TRUE. The output rung (ENO) keeps the same value as the input rung.

In IL, the input must be loaded in the current result before calling the function.

3.11.6.4 ST Language

Q := SIN (IN);

3.11.6.5 FBD Language

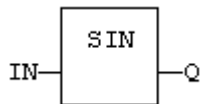

3.11.6.6 FFLD Language

(* The function is executed only if EN is TRUE *)

(* ENO keeps the same value as EN *)

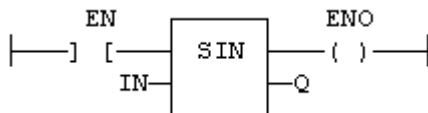

3.11.6.7 IL Language:

Op1: LD IN

SIN

ST Q (* Q is: SIN (IN) *)

See also

[COS](#) [TAN](#) [ASIN](#) [ACOS](#) [ATAN](#) [ATAN2](#)

3.11.7 TAN / TANL PLCopen

Function - Calculate a tangent.

3.11.7.1 Inputs

IN : REAL/LREAL Real value

3.11.7.2 Outputs

Q : REAL/LREAL Result: tangent of IN

3.11.7.3 Remarks

In FFLD language, the operation is executed only if the input rung (EN) is TRUE. The output rung (ENO) keeps the same value as the input rung.

In IL, the input must be loaded in the current result before calling the function.

3.11.7.4 ST Language

Q := TAN (IN);

3.11.7.5 FBD Language

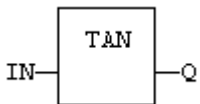

3.11.7.6 FFLD Language

(* The function is executed only if EN is TRUE *)

(* ENO keeps the same value as EN *)

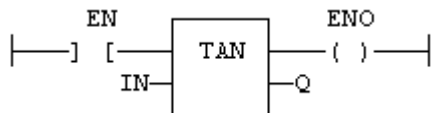

3.11.7.7 IL Language:

Op1: LD IN

TAN

ST Q (* Q is: TAN (IN) *)

See also

[SIN](#) [COS](#) [ASIN](#) [ACOS](#) [ATAN](#) [ATAN2](#)

3.1.1.8 UseDegrees PLCopen

Function - Sets the unit for angles in all trigonometric functions.

3.1.1.8.1 Inputs

IN : BOOL If TRUE, turn all trigonometric functions to use degrees
 If FALSE, turn all trigonometric functions to use radians (default)

3.1.1.8.2 Outputs

Q : BOOL TRUE if functions use degrees before the call

3.1.1.8.3 Remarks

This function sets the working unit for the following functions:

SIN	sine
COS	cosine
TAN	tangent
ASIN	arc-sine
ACOS	arc-cosine
ATAN	arc-tangent
ATAN2	arc-tangent of Y / X

3.1.1.8.4 ST Language

Q := UseDegrees (IN);

3.1.1.8.5 FBD Language

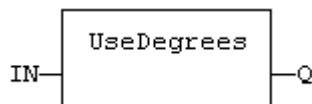

3.1.1.8.6 FFLD Language

(* Input is the rung. The rung is the output *)

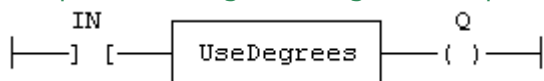

3.1.1.8.7 IL Language

```
Op1: LD IN
      UseDegrees
      ST Q
```

3.12 String operations

Below are the standard operators and functions that manage character strings:

+	concatenation of strings
CONCAT	concatenation of strings
MLEN	get string length
DELETE	delete characters in a string
INSERT	insert characters in a string
FIND	find characters in a string
REPLACE	replace characters in a string
LEFT	extract a part of a string on the left
RIGHT	extract a part of a string on the right
MID	extract a part of a string
CHAR	build a single character string
ASCII	get the ASCII code of a character within a string
ATOH	converts string to integer using hexadecimal basis
HTOA	converts integer to string using hexadecimal basis
CRC16	CRC16 calculation
ArrayToString	copies elements of an SINT array to a STRING
StringToArray	copies characters of a STRING to an SINT array

Other functions are available for managing string tables as resources:

StringTable	Select the active string table resource
LoadString	Load a string from the active string table

3.12.1 ArrayToString / ArrayToStringU PLCopen

Function - Copy an array of SINT to a STRING.

3.12.1.1 Inputs

SRC : SINT Source array of SINT small integers (USINT for ArrayToStringU)
 DST : STRING Destination STRING
 COUNT : DINT Numbers of characters to be copied

3.12.1.2 Outputs

Q : DINT Number of characters copied

3.12.1.3 Remarks

In FLD language, the operation is executed only if the input rung (EN) is TRUE. The output rung (ENO) keeps the same value as the input rung.

This function copies the COUNT first elements of the SRC array to the characters of the DST string. The function checks the maximum size of the destination string and adjust the COUNT number if necessary.

3.12.1.4 ST Language

Q := ArrayToString (SRC, DST, COUNT);

3.12.1.5 FBD Language

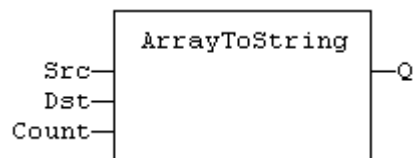

3.12.1.6 FFLD Language

(* The function is executed only if EN is TRUE *)
 (* ENO keeps the same value as EN *)

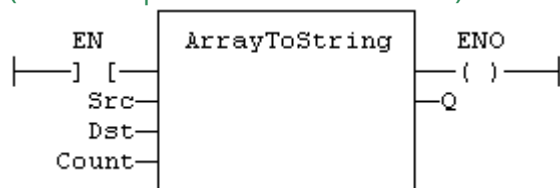

3.12.1.7 IL Language

Not available

See also

[StringToArray](#)

3.12.2 ASCII PLCopen

Function - Get the ASCII code of a character within a string

3.12.2.1 Inputs

IN : STRING Input string
 POS : DINT Position of the character within the string
 (The first valid position is 1)

3.12.2.2 Outputs

CODE : DINT ASCII code of the selected character
 or 0 if position is invalid

3.12.2.3 Remarks

In FFLD language, the input rung (EN) enables the operation, and the output rung keeps the same value as the input rung. In IL language, the first parameter (IN) must be loaded in the current result before calling the function. The other input is the operand of the function.

3.12.2.4 ST Language

CODE := ASCII (IN, POS);

3.12.2.5 FBD Language

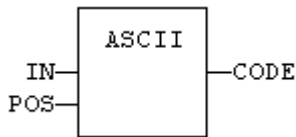

3.12.2.6 FFLD Language

(* The function is executed only if EN is TRUE *)

(* ENO is equal to EN *)

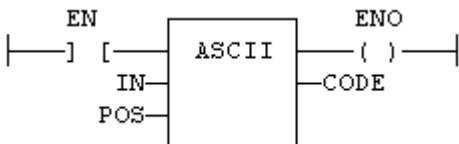

3.12.2.7 IL Language:

```
Op1: LD IN
      AND_MASK MSK
      ST CODE
```

See also

[CHAR](#)

3.12.3 ATOH PLCopen 

Function - Converts string to integer using hexadecimal basis

3.12.3.1 Inputs

IN : STRING String representing an integer in hexadecimal format

3.12.3.2 Outputs

Q : DINT Integer represented by the string

3.12.3.3 Truth table (examples)

IN	Q
' '	0
'12'	18
'a0'	160
'A0zzz'	160

3.12.3.4 Remarks

The function is case insensitive. The result is 0 for an empty string. The conversion stops before the first invalid character. In FFLD language, the operation is executed only if the input rung (EN) is TRUE. The output rung (ENO) keeps the same value as the input rung.

In IL, the input must be loaded in the current result before calling the function.

3.12.3.5 ST Language

Q := ATOH (IN);

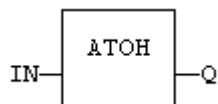
3.12.3.6 FBD Language**3.12.3.7 FFLD Language**

(* The function is executed only if EN is TRUE *)

(* ENO keeps the same value as EN *)

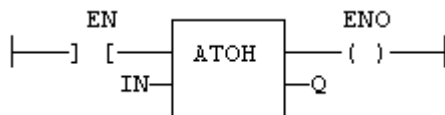
**3.12.3.8 IL Language:**

```
Op1: LD IN
      ATOH
      ST Q
```

See also

[HTOA](#)

3.12.4 CHAR PLCopen

Function - Builds a single character string

3.12.4.1 Inputs

CODE : DINT ASCII code of the wished character

3.12.4.2 Outputs

Q : STRING STRING containing only the specified character

3.12.4.3 Remarks

In FFLD language, the input rung (EN) enables the operation, and the output rung keeps the same value as the input rung. In IL language, the input parameter (CODE) must be loaded in the current result before calling the function.

3.12.4.4 ST Language

Q := CHAR (CODE);

3.12.4.5 FBD Language

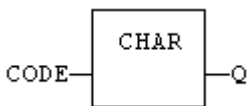

3.12.4.6 FFLD Language

(* The function is executed only if EN is TRUE *)

(* ENO is equal to EN *)

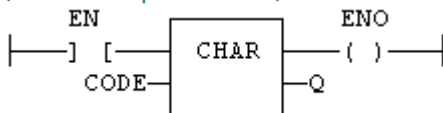

3.12.4.7 IL Language:

Op1: LD CODE
 CHAR
 ST Q

See also

[ASCII](#)

3.12.5 CONCAT PLCopen

Function - Concatenate strings.

3.12.5.1 Inputs

IN_1 : STRING Any string variable or constant expression

...

IN_N : STRING Any string variable or constant expression

3.12.5.2 Outputs

Q : STRING Concatenation of all inputs

3.12.5.3 Remarks

In FBD or FFLD language, the block can have up to 16 inputs. In IL or ST, the function accepts a variable number of inputs (at least 2).

Note that you also can use the "+" operator to concatenate strings.

3.12.5.4 ST Language

```
Q := CONCAT('AB', 'CD', 'E');
(* now Q is 'ABCDE' *)
```

3.12.5.5 FBD Language

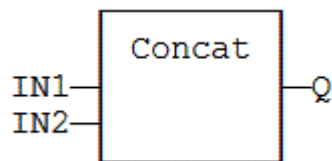

3.12.5.6 FFLD Language

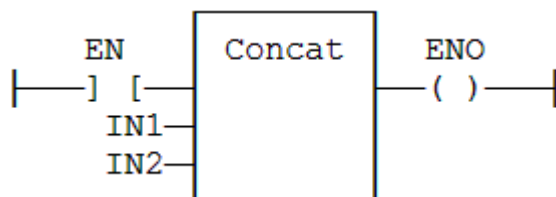

3.12.5.7 IL Language

```
Op1: FFLD 'AB'
CONCAT 'CD', 'E'
ST Q (* Q is now 'ABCDE' *)
```

3.12.6 CRC16 PLCopen

Function - calculates a CRC16 on the characters of a string

3.12.6.1 Inputs

IN : STRING character string

3.12.6.2 Outputs

Q : INT CRC16 calculated on all the characters of the string.

3.12.6.3 Remarks

In FFLD language, the input rung (EN) enables the operation, and the output rung keeps the same value as the input rung. In IL language, the input parameter (IN) must be loaded in the current result before calling the function.

The function calculates a Modbus CRC16, initialized at 16#FFFF value.

3.12.6.4 ST Language

Q := CRC16 (IN);

3.12.6.5 FBD Language

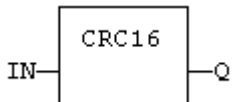

3.12.6.6 FFLD Language

(* The function is executed only if EN is TRUE *)

(* ENO is equal to EN *)

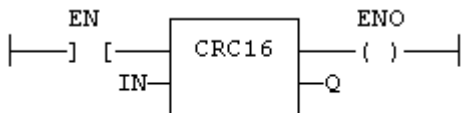

3.12.6.7 IL Language:

```
Op1: LD IN
      CRC16
      ST Q
```

3.12.7 DELETE PLCopen

Function - Delete characters in a string.

3.12.7.1 Inputs

IN : STRING Character string
 NBC : DINT Number of characters to be deleted
 POS : DINT Position of the first deleted character (first character position is 1)

3.12.7.2 Outputs

Q : STRING Modified string.

3.12.7.3 Remarks

The first valid character position is 1. In FLD language, the operation is executed only if the input rung (EN) is TRUE. The output rung (ENO) keeps the same value as the input rung.

In IL, the first input (the string) must be loaded in the current result before calling the function. Other arguments are operands of the function, separated by comas.

3.12.7.4 ST Language

Q := DELETE (IN, NBC, POS);

3.12.7.5 FBD Language

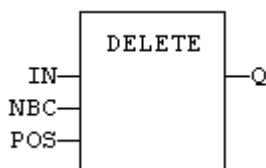

3.12.7.6 FFLD Language

(* The function is executed only if EN is TRUE *)
 (* ENO keeps the same value as EN *)

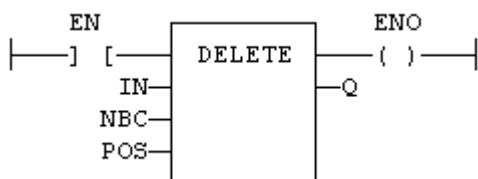

3.12.7.7 IL Language:

```
Op1: LD IN
      DELETE NBC, POS
      ST Q
```

See also

+ [MLEN](#) [INSERT](#) [FIND](#) [REPLACE](#) [LEFT](#) [RIGHT](#) [MID](#)

3.12.8 FIND PLCopen

Function - Find position of characters in a string.

3.12.8.1 Inputs

IN	STRING	Character string
STR	STRING	Specific characters to search for within the STRING

3.12.8.2 Outputs

POS	DINT	Position of the first character of STR in IN, or 0 if not found.
------------	-------------	--

3.12.8.3 Remarks

The first valid character position is 1. A return value of 0 means that the STR string has not been found. Search is case sensitive. In FFLD language, the operation is executed only if the input rung (EN) is TRUE. The output rung (ENO) keeps the same value as the input rung.

In IL, the first input (the string) must be loaded in the current result before calling the function. The second argument is the operand of the function.

3.12.8.4 ST Language

POS := FIND (IN, STR);

3.12.8.5 FBD Language

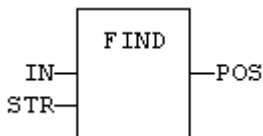

3.12.8.6 FFLD Language

(* The function is executed only if EN is TRUE *)

(* ENO keeps the same value as EN *)

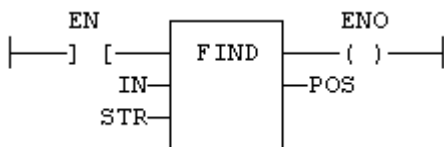

3.12.8.7 IL Language:

Op1: LD IN
 FIND STR
 ST POS

See also

+ [MLEN](#) [DELETE](#) [INSERT](#) [REPLACE](#) [LEFT](#) [RIGHT](#) [MID](#)

3.12.9 HTOA PLCopen 

Function - Converts integer to string using hexadecimal basis

3.12.9.1 Inputs

IN : DINT Integer value

3.12.9.2 Outputs

Q : STRING String representing the integer in hexadecimal format

3.12.9.3 Truth table (examples)

IN	Q
0	'0'
18	'12'
160	'A0'

3.12.9.4 Remarks

In FFLD language, the operation is executed only if the input rung (EN) is TRUE. The output rung (ENO) keeps the same value as the input rung.

In IL, the input must be loaded in the current result before calling the function.

3.12.9.5 ST Language

Q := HTOA (IN);

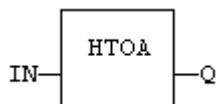
3.12.9.6 FBD Language**3.12.9.7 FFLD Language**

(* The function is executed only if EN is TRUE *)
 (* ENO keeps the same value as EN *)

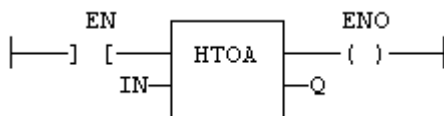
**3.12.9.8 IL Language:**

Op1: LD IN
 HTOA
 ST Q

See also

[ATOH](#)

3.12.10 INSERT PLCopen

Function - Insert characters in a string.

3.12.10.1 Inputs

- IN : STRING Character string
- STR : STRING String containing characters to be inserted
- POS : DINT Position of the first inserted character (first character position is 1)

3.12.10.2 Outputs

- Q : STRING Modified string.

3.12.10.3 Remarks

The first valid character position is 1. In FFLD language, the operation is executed only if the input rung (EN) is TRUE. The output rung (ENO) keeps the same value as the input rung.

In IL, the first input (the string) must be loaded in the current result before calling the function. Other arguments are operands of the function, separated by comas.

3.12.10.4 ST Language

Q := INSERT (IN, STR, POS);

3.12.10.5 FBD Language

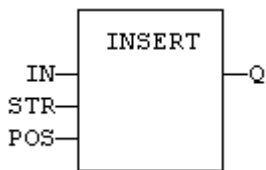

3.12.10.6 FFLD Language

- (* The function is executed only if EN is TRUE *)
- (* ENO keeps the same value as EN *)

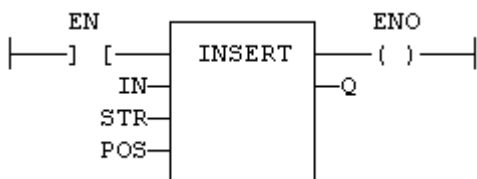

3.12.10.7 IL Language:

```
Op1: LD IN
      INSERT STR, POS
      ST Q
```

See also

+ [MLEN](#) [DELETE](#) [FIND](#) [REPLACE](#) [LEFT](#) [RIGHT](#) [MID](#)

3.12.11 LEFT PLCopen 

Function - Extract characters of a string on the left.

3.12.11.1 Inputs

IN : STRING Character string
NBC : DINT Number of characters to extract

3.12.11.2 Outputs

Q : STRING String containing the first NBC characters of IN.

3.12.11.3 Remarks

In FFLD language, the operation is executed only if the input rung (EN) is TRUE. The output rung (ENO) keeps the same value as the input rung.

In IL, the first input (the string) must be loaded in the current result before calling the function. The second argument is the operand of the function.

3.12.11.4 ST Language

Q := LEFT (IN, NBC);

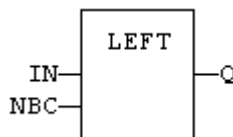
3.12.11.5 FBD Language**3.12.11.6 FFLD Language**

(* The function is executed only if EN is TRUE *)
(* ENO keeps the same value as EN *)

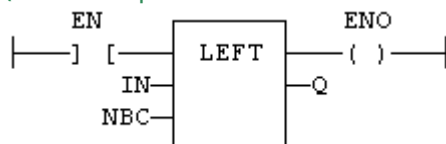
**3.12.11.7 IL Language:**

```
Op1: LD IN
      LEFT NBC
      ST Q
```

See also

+ MLEN DELETE INSERT FIND REPLACE RIGHT MID

3.12.12 LoadString PLCopen

Function - Load a string from the active string table.

3.12.12.1 Inputs

ID: DINT ID of the string as declared in the string table

3.12.12.2 Outputs

Q : STRING Loaded string or empty string in case of error

3.12.12.3 Remarks

This function loads a string from the active string table and stores it into a STRING variable. The [StringTable\(\)](#) function is used for selecting the active string table.

The "ID" input (the string item identifier) is an identifier such as declared within the string table resource. You don't need to "define" again this identifier. The system does it for you.

3.12.12.4 ST Language

Q := LoadString (ID);

3.12.12.5 FBD Language

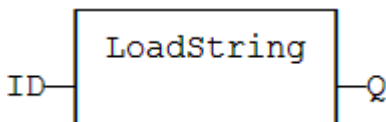

3.12.12.6 FFLD Language

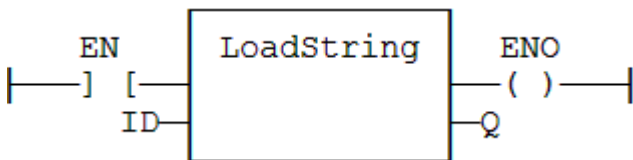

3.12.12.7 IL Language:

```
Op1: LD    ID
      LoadString
      ST    Q
```

See also

[StringTable](#) String tables

3.12.13 MID PLCopen 

Function - Extract characters of a string at any position.

3.12.13.1 Inputs

IN : STRING Character string
 NBC : DINT Number of characters to extract
 POS : DINT Position of the first character to extract (first character of IN is at position 1)

3.12.13.2 Outputs

Q : STRING String containing the first NBC characters of IN.

3.12.13.3 Remarks

The first valid position is 1. In FFLD language, the operation is executed only if the input rung (EN) is TRUE. The output rung (ENO) keeps the same value as the input rung.

In IL, the first input (the string) must be loaded in the current result before calling the function. Other arguments are operands of the function, separated by comas.

3.12.13.4 ST Language

Q := MID (IN, NBC, POS);

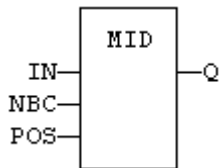
3.12.13.5 FBD Language**3.12.13.6 FFLD Language**

(* The function is executed only if EN is TRUE *)

(* ENO keeps the same value as EN *)

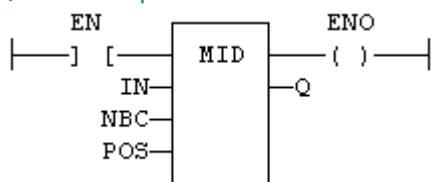
**3.12.13.7 IL Language:**

Op1: LD IN
 MID NBC, POS
 ST Q

See also

+ MLEN DELETE INSERT FIND REPLACE LEFT RIGHT

3.12.14 MLEN PLCopen

Function - Get the number of characters in a string.

3.12.14.1 Inputs

IN : STRING Character string

3.12.14.2 Outputs

NBC : DINT Number of characters currently in the string. 0 if string is empty.

3.12.14.3 Remarks

In FFLD language, the operation is executed only if the input rung (EN) is TRUE. The output rung (ENO) keeps the same value as the input rung.

In IL, the input must be loaded in the current result before calling the function.

3.12.14.4 ST Language

NBC := MLEN (IN);

3.12.14.5 FBD Language

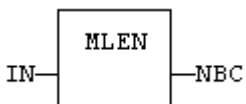

3.12.14.6 FFLD Language

(* The function is executed only if EN is TRUE *)

(* ENO keeps the same value as EN *)

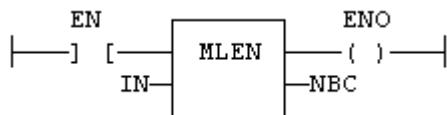

3.12.14.7 IL Language:

Op1: LD IN

MLEN

ST NBC

See also

+ DELETE INSERT FIND REPLACE LEFT RIGHT MID

3.12.15 REPLACE PLCopen 

Function - Replace characters in a string.

3.12.15.1 Inputs

IN : STRING Character string
 STR : STRING String containing the characters to be inserted
 in place of NDEL removed characters
 NDEL : DINT Number of characters to be deleted before insertion of STR
 POS : DINT Position where characters are replaced (first character position is 1)

3.12.15.2 Outputs

Q : STRING Modified string.

3.12.15.3 Remarks

The first valid character position is 1. In FLD language, the operation is executed only if the input rung (EN) is TRUE. The output rung (ENO) keeps the same value as the input rung.

In IL, the first input (the string) must be loaded in the current result before calling the function. Other arguments are operands of the function, separated by comas.

3.12.15.4 ST Language

Q := REPLACE (IN, STR, NDEL, POS);

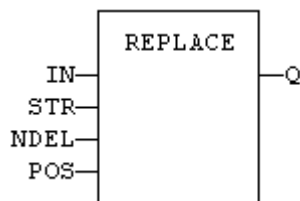
3.12.15.5 FBD Language**3.12.15.6 FFLD Language**

(* The function is executed only if EN is TRUE *)
 (* ENO keeps the same value as EN *)

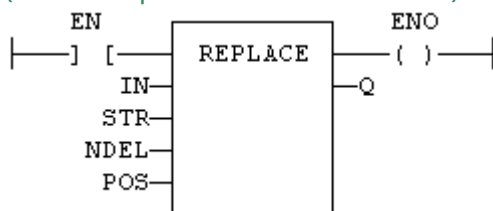
**3.12.15.7 IL Language:**

```
Op1: LD IN
      REPLACE STR, NDEL, POS
      ST Q
```

See also

+ MLEN DELETE INSERT FIND LEFT RIGHT MID

3.12.16 RIGHT PLCopen

Function - Extract characters of a string on the right.

3.12.16.1 Inputs

IN : STRING Character string
 NBC : DINT Number of characters to extract

3.12.16.2 Outputs

Q : STRING String containing the last NBC characters of IN.

3.12.16.3 Remarks

In FFLD language, the operation is executed only if the input rung (EN) is TRUE. The output rung (ENO) keeps the same value as the input rung.

In IL, the first input (the string) must be loaded in the current result before calling the function. The second argument is the operand of the function.

3.12.16.4 ST Language

Q := RIGHT (IN, NBC);

3.12.16.5 FBD Language

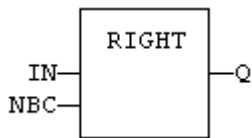

3.12.16.6 FFLD Language

(* The function is executed only if EN is TRUE *)
 (* ENO keeps the same value as EN *)

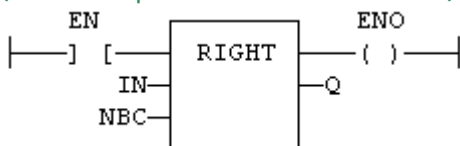

3.12.16.7 IL Language:

Op1: LD IN
 RIGHT NBC
 ST Q

See also

+ [MLEN](#) [DELETE](#) [INSERT](#) [FIND](#) [REPLACE](#) [LEFT](#) [MID](#)

3.12.17 StringTable PLCopen

Function - Selects the active string table.

3.12.17.1 Inputs

TABLE : STRING Name of the Sting Table resource - *must be a constant*
 COL : STRING Name of the column in the table - *must be a constant*

3.12.17.2 Outputs

OK : BOOL TRUE if OK

3.12.17.3 Remarks

This function selects a column of a valid String Table resource to become the active string table. The [LoadString\(\)](#) function always refers to the active string table.

Arguments must be constant string expressions and must fit to a declared string table and a valid column name within this table.

If you have only one string table with only one column defined in your project, you do not need to call this function as it will be the default string table anyway.

3.12.17.4 ST Language

```
OK := StringTable ('MyTable', 'FirstColumn');
```

3.12.17.5 FBD Language

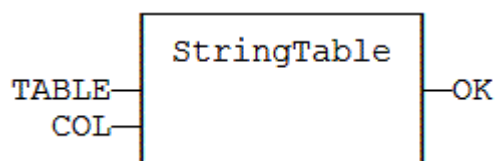

3.12.17.6 FFLD Language

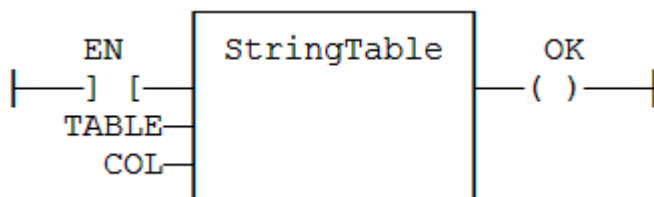

3.12.17.7 IL Language:

```
Op1: LD 'MyTable'  
StringTable 'First Column'  
ST OK
```

See also

[LoadString](#) String tables

3.12.17.8 String Table Resources

String tables are resources (embedded configuration data) edited with the Workbench. A string table is a list of items identified by a name and referring to one or more character strings.

String tables are typically used for defining static texts to be used in the application. The following functions can be used for getting access to string tables in the programs:

StringTable: selects the active string table.

LoadString: Load a string from the active table.

In addition, each string table may contain several columns of texts for each item, and thus ease the localization of application, simply by defining a column for each language. This way the language can be selected dynamically at runtime, simply by specifying the active language (as a column) in the StringTable() function.

The name entered in the string table as an "ID" is automatically declared for the compiler and can directly be passed to the LoadString() function without re-declaring it. The name must conform to IEC standard naming rules.

Obviously, you could do the same by declaring an array of STRING variables and enter some initial values for all items in the array. By the way, string tables provide significant advantages compared to arrays:

- The editor provides a comfortable view of multiple columns at editing.
- String tables are loaded in the application code and does not require any further RAM memory unlike declared arrays.
- The string table editor automatically declares for you readable IDs for any string item to be used in programs instead of working with hard-coded index values.

TIP

If the text is too long for the STRING variable when used at runtime, it is truncated. You can use special '\$' sequences in strings in order to specify non printable characters, according to the IEC standard:

Code	Meaning
\$\$	A "\$" character
\$'	A Single quote
\$T	A tab stop (ASCII code 9)
\$R	A carriage return character (ASCII code 13)
\$L	A line feed character (ASCII code 10)
\$N	Carriage return plus line feed characters (ASCII codes 13 and 10)
\$P	A page break character (ASCII code 12)
\$xx	Any character (xx is the ASCII code expressed on two hexadecimal digits)

3.12.18 StringToArray / StringToArrayU PLCopen ✓

Function - Copies the characters of a STRING to an array of SINT.

3.12.18.1 Inputs

SRC : STRING Source STRING
 DST : SINT Destination array of SINT small integers (USINT for StringToArrayU)

3.12.18.2 Outputs

Q : DINT Number of characters copied

3.12.18.3 Remarks

In FFLD language, the operation is executed only if the input rung (EN) is TRUE. The output rung (ENO) keeps the same value as the input rung.

In IL, the input must be loaded in the current result before calling the function.

This function copies the characters of the SRC string to the first characters of the DST array. The function checks the maximum size destination arrays and reduces the number of copied characters if necessary.

3.12.18.4 ST Language

Q := StringToArray (SRC, DST);

3.12.18.5 FBD Language

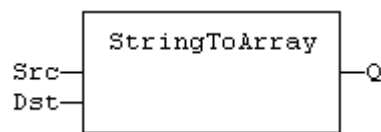

3.12.18.6 FFLD Language

(* The function is executed only if EN is TRUE *)

(* ENO keeps the same value as EN *)

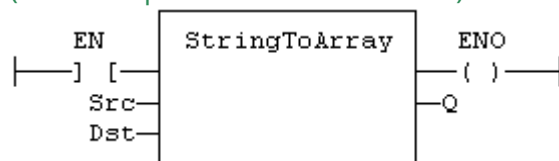

3.12.18.7 IL Language:

Op1: LD SRC
 StringToArray DST
 ST Q

See also

[ArrayToString](#)

4 PLC Advanced Libraries

Below are the standard blocks that perform advanced operations.

Analog signal processing:

Block	Description
Average / AverageL	Calculate the average of signal samples
Integral	Calculate the integral of a signal
Derivate	Derive a signal
PID	PID loop
Ramp	Ramp signal
Rand	Give a Random value modulo the input value
Lim_Alm	Low / High level detection
Hyster , HysterAcc	Hysterisis calculation
SigPlay	Play an analog signal from a resource
SigScale	Get a point from a signal resource
CurveLin	Linear interpolation on a curve
SurfLin	Linear interpolation on a surface

Alarm management:

Block	Description
Lim_Alm	Low / High level detection
Alarm_M	Alarm with manual reset
ALARM_A	Alarm with automatic reset

Data collections and serialization:

Block	Description
StackInt	Stack of integers
FIFO	"First in / first out" list
LIFO	"Last in / first out" stack
SerializeIn	Extract data from a binary frame.
SerializeOut	Write data to a binary frame.

Data Logging:

Block	Description
LogFileCSV	Log values of variables to a CSV file

Special operations:

Block	Description
GetSysInfo	Get system information
Printf	Trace messages
CycleStop	Sets the application in cycle stepping mode
FatalStop	Breaks the cycle and stop with fatal error
EnableEvents	Enable / disable produced events for binding

Block	Description
ApplyRecipeColumn	Apply the values of a column from a recipe file
VLID	Get the ID of an embedded list of variables
SigID	Get the ID of a signal resource

Communication:

[AS-interface](#)

Others:

[Real Time Clock](#)

[File Tools Function Blocks](#)

4.1 ALARM_A PLCopen

Function Block - Alarm with automatic reset

4.1.1 Inputs

IN : BOOL Process signal
 ACK : BOOL Acknowledge command

4.1.2 Outputs

Q : BOOL TRUE if alarm is active
 QACK : BOOL TRUE if alarm is acknowledged

4.1.3 Sequence

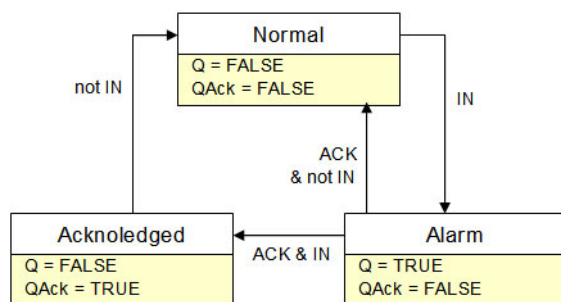

4.1.4 Remarks

Combine this block with the [LIM_ALARM](#) block for managing analog alarms.

4.1.5 ST Language

```

(* MyALARM is declared as an instance of ALARM_A function block *)
MyALARM (IN, ACK);
Q := MyALARM.Q;
QACK := MyALARM.QACK;
    
```

4.1.6 FBD Language

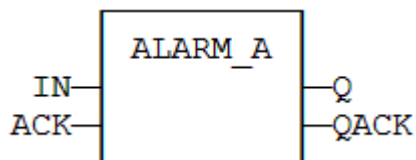

4.1.7 FFLD Language

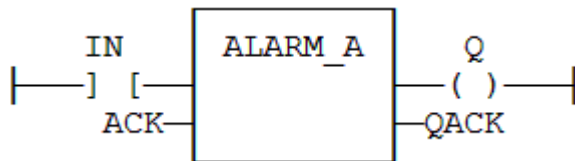

4.1.8 IL Language

```
(* MyALARM is declared as an instance of ALARM_A function block *)
Op1: CAL
MyALARM (IN, ACK)
FFLD MyALARM.Q
ST Q
FFLD MyALARM.QACK
ST
QACK
```

See also

[ALARM_M](#) [LIM_ALRM](#)

4.2 ALARM_M PLCopen

Function Block - Alarm with manual reset

4.2.1 Inputs

IN : BOOL Process signal
 ACK : BOOL Acknowledge command
 RST : BOOL Reset command

4.2.2 Outputs

Q : BOOL TRUE if alarm is active
 QACK : BOOL TRUE if alarm is acknowledged

4.2.3 Sequence

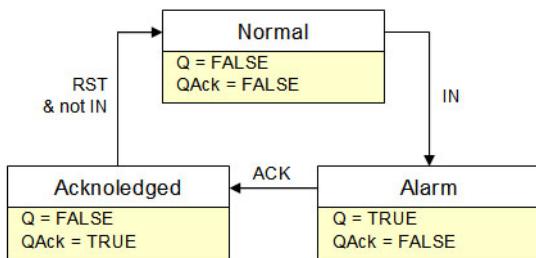

4.2.4 Remarks

Combine this block with the [LIM_ALARM](#) block for managing analog alarms.

4.2.5 ST Language

```

(* MyALARM is declared as an instance of ALARM_M function block *)
MyALARM (IN, ACK, RST);
Q := MyALARM.Q;
QACK := MyALARM.QACK;
    
```

4.2.6 FBD Language

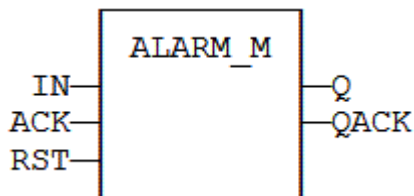

4.2.7 FFLD Language

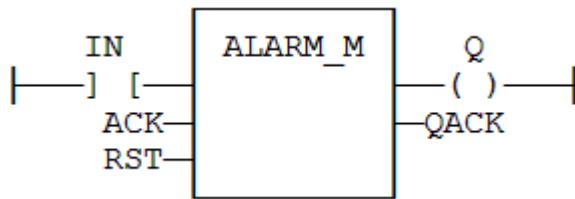

4.2.8 IL Language

```

(* MyALARM is declared as an instance of ALARM_M function block *)
Op1: CAL
MyALARM (IN, ACK, RST)
FFLD MyALARM.Q
ST Q
FFLD MyALARM.QACK
ST
QACK

```

See also

[ALARM_A](#) [LIM_ALRM](#)

4.3 ApplyRecipeColumn

Function - Apply the values of a column from a recipe file

4.3.1 Inputs

FILE : STRING Path name of the recipe file (.RCP or .CSV) - *must be a constant value!*
COL : DINT Index of the column in the recipe (0 based)

See an example of RCP file

```
@COLNAME=Col3 Col4
@SIZECOL1=100
@SIZECOL2=100
@SIZECOL3=100
@SIZECOL4=100
bCommand
tPerio
bFast
Blink1
test_var
bOut
@EXPANDED=Blink1
```

See an example of CSV file

Example of CSV file with five variables and five set of values

```
comment lines here
TravelSpeed;100;200;300;400;500
MasterAbsPos;0;45;90;135;180
MasterDeltaPos;0;90;180;270;360
MachineSpeed;50;100;150;200;250
MachineState;0;0;1;1;2
```

NOTE

For your CSV file to be valid, ensure the data are separated with **semicolons** (and not commas).

Usage in a FFLD program where column 3 is selected

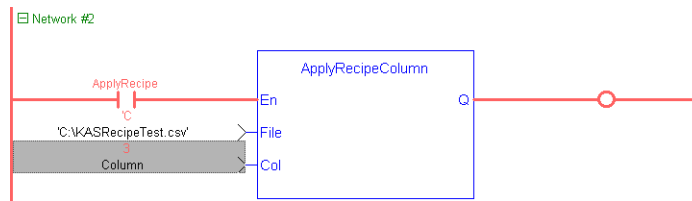

Column 3 corresponds to column E in the Excel sheet because this parameter is 0 based

	A	B	C	D	E	F
1	comment lines here					
2	TravelSpeed	100	200	300	400	500
3	MasterAbsPos	0	45	90	135	180
4	MasterDeltaPos	0	90	180	270	360
5	MachineSpeed	50	100	150	200	250
6	MachineState	0	0	1	1	2

Result displayed in the Dictionary when the application is running

Name	Value	Type
Global variables		
TravelSpeed	400.0000...	LREAL
MasterAbsPos	135.0000...	LREAL
MasterDeltaPos	270.0000...	LREAL
MachineSpeed	200.0000...	LREAL
Axis1Status	447	DINT
Axis2Status	447	DINT
MachineState	1	DINT

4.3.2 Outputs

OK : BOOL TRUE if OK - FALSE if parameters are invalid

4.3.3 Remarks

- The 'FILE' input is a constant string expression specifying the path name of a valid .RCP or .CSV file. If no path is specified, the file is assumed to be located in the project folder. RCP files are created using an external recipe editor. CSV files can be created using EXCEL or NOTEPAD.
- In CSV files, the first line must contain column headers, and is ignored during compiling. There is one variable per line. The first column contains the symbol of the variable. Other columns are values.
- If a cell is empty, it is assumed to be the same value as the previous (left side) cell. If it is the first cell of a row, it is assumed to be null (0 or FALSE or empty string).
- In FFLD language, the operation is executed only if the input rung (EN) is TRUE. The output rung is the result of the function.

! IMPORTANT

Recipe files are read at compiling time and are embedded into the downloaded application code. This implies that a modification performed in the recipe file after downloading is not taken into account by the application.

4.3.4 ST Language

```
OK := ApplyRecipeColumn ('MyFile.rcp', COL);
```

4.3.5 FBD Language

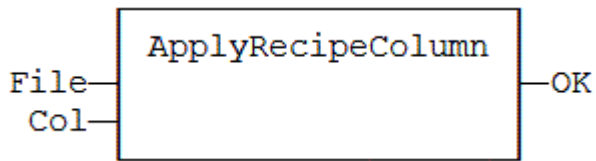

4.3.6 FFLD Language

(* The function is executed only if ApplyRecipe is TRUE *)

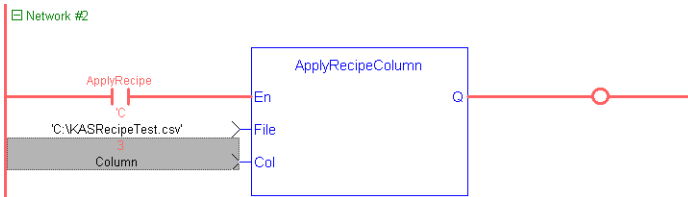

4.3.7 IL Language

```
Op1: LD
'MyFile.rcp'
ApplyRecipeColumn COL
ST
OK
```

4.4 AS-interface Functions

The following functions enable special operation on AS-i networks:

ASiReadPP	read permanent parameters of an AS-i slave
ASiWritePP	write permanent parameters of an AS-i slave
ASiSendParam	send parameters to an AS-i slave
ASiReadPI	read actual parameters of an AS-i slave
ASiStorePI	store actual parameters as permanent parameters

⚠ IMPORTANT

AS-i networking may be not available on some targets. Please refer to OEM instructions for further details about available features.

Interface

```
Params := ASiReadPP (Master, Slave);
bOK := ASiWritePP (Master, Slave, Params);
bOK := ASiSendParam (Master, Slave, Params);
Params := ASiReadPI (Master, Slave);
bOK := ASiStorePI (Master);
```

Arguments

Master : DINT Index of the AS-i master (1..N) such as shown in configuration
 Slave : DINT Address of the AS-i slave (1..32 / 33..63)
 Params : DINT Value of AS-i parameters
 bOK : BOOL TRUE if successful

4.5 AVERAGE / AVERAGEL PLCopen

Function Block - Calculates the average of signal samples.

4.5.1 Inputs

RUN : BOOL Enabling command
 XIN : REAL Input signal
 N : DINT Number of samples stored for average calculation - Cannot exceed 128

4.5.2 Outputs

XOUT : REAL Average of the stored samples (*)

(*) AVERAGEL has LREAL arguments.

4.5.3 Remarks

The average is calculated according to the number of stored samples, which can be less than N when the block is enabled. By default the number of samples is 128.

The "N" input (or the number of samples) is taken into account *only* when the RUN input is FALSE.

TIP

The "RUN" needs to be reset after a change in the number of samples. You should cycle the RUN input when you first call this function, this will clear the default.

NOTE

In FFLD language, the input rung is the RUN command. The output rung keeps the state of the input rung.

4.5.4 ST Language

```
(* MyAve is a declared instance of AVERAGE function block *)
MyAve (RUN, XIN, N);
XOUT := MyAve.XOUT;
```

4.5.5 FBD Language

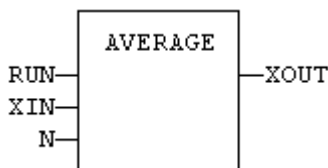

4.5.6 FFLD Language

(* ENO has the same state as RUN *)

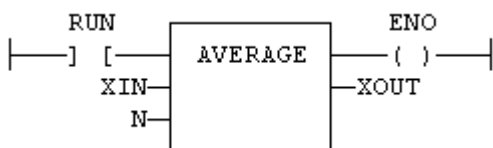

4.5.7 IL Language:

```
(* MyAve is a declared instance of AVERAGE function block *)  
Op1: CAL MyAve (RUN, XIN, N)  
      FFLD MyAve.XOUT  
      ST  XOUT
```

See also

[INTEGRAL](#) [DERIVATE](#) [LIM_ALRM](#) [HYSTER](#) [STACKINT](#)

4.6 CurveLin

Function block- Linear interpolation on a curve.

4.6.1 Inputs

X : REAL X coordinate of the point to be interpolated.

XAxis : REAL[] X coordinates of the known points of the X axis.

YVal : REAL[] Y coordinate of the points defined on the X axis.

4.6.2 Outputs

Y : REAL Interpolated Y value corresponding to the X input

OK : BOOL TRUE if successful.

ERR : DINT Error code if failed - 0 if OK.

4.6.3 Remarks

This function performs linear interpolation in between a list of points defined in the XAxis single dimension array. The output Y value is an interpolation of the Y values of the two rounding points defined in the X axis. Y values of defined points are passed in the YVal single dimension array.

Values in XAxis must be sorted from the smallest to the biggest. There must be at least two points defined in the X axis. YVal and XAxis input arrays must have the same dimension.

In case the X input is less than the smallest defined X point, the Y output takes the first value defined in YVal and an error is reported. In case the X input is greater than the biggest defined X point, the Y output takes the last value defined in YVal and an error is reported.

The ERR output gives the cause of the error if the function fails:

Error Code	Meaning
0	OK
1	Invalid dimension of input arrays
2	Invalid points for the X axis
4	X is out of the defined X axis

4.7 DERIVATE PLCopen

Function Block - Computes the derivative of a signal with respect to time.

The time unit is seconds. The output signal has the units of the input signal divided by seconds. The DERIVATE block samples the input signal at a maximum rate of 1 millisecond.

4.7.1 Inputs

RUN : BOOL Run command: TRUE=derivate / FALSE=hold
 XIN : REAL Input signal
 CYCLE : TIME Sampling period (must not be less than the target cycle timing)

4.7.2 Outputs

XOUT : REAL Output signal

4.7.3 Remarks

In FFLD language, the input rung is the RUN command. The output rung keeps the state of the input rung.

4.7.4 ST Language

(* MyDerv is a declared instance of DERIVATE function block *)

```
MyDerv (RUN, XIN, CYCLE);
XOUT := MyDerv.XOUT;
```

4.7.5 FBD Language

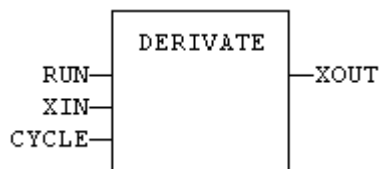

4.7.6 FFLD Language

(* ENO has the same state as RUN *)

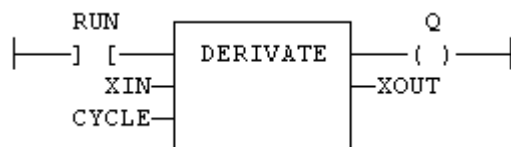

4.7.7 IL Language:

(* MyDerv is a declared instance of DERIVATE function block *)

```
Op1: CAL MyDerv (RUN, XIN, CYCLE)
FFLD MyDerv.XOUT
ST XOUT
```

See also

[AVERAGE](#) [INTEGRAL](#) [LIM_ALARM](#) [HYSTERSTACKINT](#)

4.8 EnableEvents PLCopen

Function - Enable or disable the production of events for binding(runtime to runtime variable exchange)

4.8.1 Inputs

EN : BOOL TRUE to enable events / FALSE to disable events

4.8.2 Outputs

ENO : BOOL Echo of EN input

4.8.3 Remarks

Production is enabled when the application starts. The first production will be operated after the first cycle. So to disable events since the beginning, you must call `EnableEvents (FALSE)` in the very first cycle.

In FFLD language, the input rung (EN) enables the event production, and the output rung keeps the state of the input rung. In IL language, the input must be loaded before the function call.

4.8.4 ST Language

ENO := EnableEvents (EN);

4.8.5 FBD Language

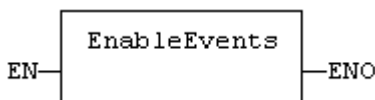

4.8.6 FFLD Language

(* Events are enables if EN is TRUE *)

(* ENO has the same value as EN *)

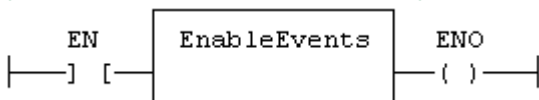

4.8.7 IL Language:

```
Op1: LD EN
      EnableEvents
      ST ENO
```

4.9 FIFO PLCopen

Function block - Manages a "first in / first out" list

4.9.1 Inputs

PUSH	BOOL	Push a new value (on rising edge)
POP	BOOL	Pop a new value (on rising edge)
RST	BOOL	Reset the list
IN	ANY	Value to be pushed
@Tail	ANY	Value of the oldest pushed value - <i>updated after call!</i>
Buf[]	ANY	Array for storing values

4.9.2 Outputs

EMPTY	BOOL	TRUE if the list is empty
OFLO	BOOL	TRUE if overflow on a PUSH command
Count	DINT	Number of values in the list
pRead	DINT	Index in the buffer of the oldest pushed value
pWrite	DINT	Index in the buffer of the next push position

4.9.3 Remarks

IN, @Tail and Buf[] must have the same data type *and cannot be STRING*.

The @Tail argument specifies a variable which is filled with the oldest push value after the block is called.

Values are stored in the "BUF" array. Data is arranged as a roll over buffer and is never shifted or reset. Only read and write pointers and pushed values are updated. The maximum size of the list is the dimension of the array.

The first time the block is called, it remembers on which array it should work. If you call later the same instance with another BUF input, the call is considered as invalid and makes nothing. Outputs reports an empty list in this case.

In FFLD language, input rung is the PUSH input. The output rung is the EMPTY output.

4.9.4 ST Language

```
(* MyFIFO is a declared instance of FIFO function block *)
MyFIFO (PUSH, POP, RST, IN, @Tail , BUFFER);
EMPTY := MyFIFO.EMPTY;
OFLO := MyFIFO.OFLO;
COUNT := MyFIFO.COUNT;
PREAD := MyFIFO.PREAD;
PWRITE := MyFIFO.PWRITE;
```

4.9.5 FBD Language

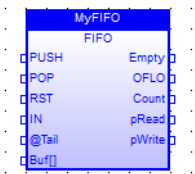

4.9.6 FFLD Language



4.9.7 IL Language

```
(* MyFIFO is a declared instance of FIFO function block *)
Op1: CAL MyFIFO (PUSH, POP, RST, IN, @Tail , BUFF[])
FFLD MyFIFO.EMPTY
ST EMPTY
FFLD MyFIFO.OFLO
ST OFLO
FFLD MyFIFO.COUNT
ST COUNT
FFLD MyFIFO.PREAD
ST PREAD
FFLD MyFIFO.PWRITE
ST PWRITE
```

See also

[LIFO](#)

4.10 File Management

File Management functions provide the ability to do the following:

- Read machine recipes or other machine operational data into the .kas program from the SD card or a shared directory.
- Read cam tables into the program from the SD card or a shared directory.
- Store machine operational data in internal PxMM flash memory (retrievable through the web server), the SD card, or a shared directory.

Please note that a shared directory connection is setup through the web server.

TIP

- If needed, functions to parse out information from a file using a string format can be found in [String operations](#).
- If the file is in .CSV format, the following functions can be used: [LogFileCSV](#), [ApplyRecipeColumn](#)
- You can create, store, and retrieve recipes and other data using:
 - the AKI Terminals. For more information see the KVB manual.
 - through an external bus connection to the PxMM with a supported fieldbus, such as UDP or HTTP.

The following function blocks enable sequential read / write operations in disk files:

Function Block	Use
FileClose	Close an open file
FileCopy	Copy a file
FileDelete	Remove a file
FileEOF	Test if the end of the file is reached in a file that is open for reading
FileExists	Test if a file exists
FileOpenA	Create or open a file in append mode
FileOpenR	Open a file for reading
FileOpenW	Create or reset a file and open it for writing
FileReadBinData	Read binary data from a file
FileReadLine	Read a string value from a text file
FileRename	Rename a file
FileSeek	Set the current position of a file
FileSize	Get the size of a file
FileWriteBinData	Write binary data to a file
FileWriteLine	Write a string value to a text file

The following functions handle mounting of SD cards.

Name	Use
SD_ISREADY	Check that the SD card is ready for read/write
SD_MOUNT	Mount an SD card
SD_UNMOUNT	Unmount an SD card

Each file is identified in the application by a unique handle manipulated as a DINT value. The file handles are allocated by the target system. Handles are returned by the Open function blocks and used by all other function blocks for identifying the file.

Related function blocks:

[LogFileCSV](#) log values of variables to a CSV file

⚠ IMPORTANT

- Files are opened and closed directly by the Operating System of the target. Opening some files can be dangerous for system safety and integrity. **The number of open files (from [FileOpenA](#), [FileOpenR](#), and [FileOpenW](#)) is limited by the resources available on the target system.**
- Ensure that each file successfully opened using [FileOpenA](#), [FileOpenR](#), and [FileOpenW](#) has a corresponding [FileClose](#) to close the file. Closing the file will release the file ID, making it available for operations on other files.
- The deprecated functions will stall the PLC, causing the controller to miss PLC cycles.
- The IDs used by the file function blocks are not compatible with the deprecated file functions.
- The IDs used by the deprecated file functions are not compatible with the file function blocks.

NOTE

- Opening a file with [FileOpenA](#), [FileOpenR](#), and [FileOpenW](#) can be unsuccessful (invalid path or file name, too many open files...) Your application must check the file ID for a NULL value. If the file ID is NULL (zero), then file read or write operations will fail.
- File management may be unavailable on some targets.
- Memory on the SD card is available in addition to the existing flash memory.
- Valid paths for storing files depend on the target implementation.
- Error messages are logged in the Controller log section of KAS Runtime where there is a failure in any related function block.
- Using the KAS Simulator, all pathnames are ignored, and files are stored in a reserved directory. Only the file name passed to the Open functions is taken into account.
- AKD PDMM / PCMM files are [big endian](#).

👉 TIP

Be sure to review [File Path Conventions](#) to understand hardware-based functional differences.

4.10.1 SD Card Access

Files may be written to and read from an SD card. This is typically used for storing a firmware image for Recovery Mode.

To use an SD card on the controller:

1. Ensure that the SD card is inserted.
2. Mount the card using [SD_MOUNT](#).
3. Ensure the card is accessible using [SD_ISREADY](#) before performing a read or write action.
4. Unmount the card, if desired, using [SD_UNMOUNT](#) after performing read/write actions.

4.10.2 SD Card Mounting Functions

The following functions handle mounting of SD cards.

Name	Use
SD_ISREADY	Check that the SD card is ready for read/write
SD_MOUNT	Mount an SD card
SD_UNMOUNT	Unmount an SD card

4.10.2.1 SD_MOUNT PLCopen

Mount the SDCard on the PDMM. This will not perform any action, and always return TRUE with a Simulator.

```
OK := SD_MOUNT ();
```

OK : BOOL TRUE if mounting SDCard is successful

NOTE

Before performing, make sure the SDCard is inserted.

TIP

It is recommended that SD_MOUNT be used only when motion is not started.

4.10.2.2 SD_UNMOUNT PLCopen

Un-mount the SDCard from the PDMM. This will not perform any action, and always return TRUE with a Simulator.

```
OK := SD_UNMOUNT ();
```

OK : BOOL TRUE if un-mounting SDCard is successful

TIP

It is recommended that SD_UNMOUNT be used only when motion is not started.

4.10.2.3 SD_ISREADY PLCopen







Verify if the SDCard is mounted on the PDMM. This will verify if the SDCard folder is available inside the userdata folder when using a Simulator.

```
OK := SD_ISREADY ();
```

OK : BOOL TRUE if the SDCard is mounted (PDMM / PCMM)

4.10.3 File Path Conventions

Depending upon the system used, paths to file locations may be defined as either absolute (C://dir1/file1) or relative (/dir1/file1). Not all systems handle all options, and the paths will vary depending upon the system.

System	Absolute Paths	Relative Paths	Handling of Directories
AKD PDMM or PCMM			There is no support for creating directories on the controller. Any path provided to the function blocks, <code>file1</code> for example, will be appended with the default userdata folder which is: <code>/mount/flash/userdata</code>
Simulator			When a relative path is provided to the function blocks, the path is appended with the default userdata folder, which is: <code><User Directory>/Kollmorgen/Kollmorgen Automation Suite/Sinope Simulator/Application/userdata</code>
PAC			When a relative path is provided to the function blocks, the path is appended with the default userdata folder, which is: <code><User Directory>/Kollmorgen/Kollmorgen Automation Suite/Sinope Runtime/Application/userdata</code>

See Also:

- [Shared Directory Path Conventions](#)
- [SD Card Path Conventions](#)
- [File Name Warning & Limitations](#)

4.10.3.1 Shared Directory Path Conventions

The AKD PDMM and PCMM support access to a shared directory on a remote computer. To access files in a shared directory from the AKD PDMM or PCMM use `' /mount/shared '` at the beginning of the path, before the shared directory's relative path and file name:

```
' /mount/shared/directory/filename'
```

Valid Paths	Notes
/mount/shared	The path is not case sensitive, so /MOUNT/SHARED, MOUNT/SHARED/, etc. are also valid.
mount/shared	
\mount\shared	
mount\shared	

Example 1: Opening the file `example.txt` from a shared directory on a remote computer.

```
fileID := F_AOPEN('/mount/shared/example.txt');
```

Example 2: Opening the file `myfiles/example.txt` from a shared directory on a remote computer.

```
fileID := F_AOPEN('/mount/shared/myfiles/example.txt');
```

See Also:

- [File Name Warning & Limitations](#)

4.10.3.2 SD Card Path Conventions

To access the SD card memory a valid SD card label must be used at the beginning of the path, followed by the relative path to the SD card. *(Valid SD Card Label)/(Relative Path)*

A valid SD card relative path starts with //, /, \\, or \. This is immediately followed by SDCard which is followed by \ or /. Please note that this path label is case insensitive.

Valid Paths	Notes
//SDCard/file1	
\Sdcard/dir1/file1	dir1 must have been already created
/sdcard/dir1/file1	dir1 must have been already created
//sdCard\file1	

Invalid Paths	Reason for being invalid
///SDCard/file1	Started with more than two forward or backward slashes
^SDcard/dir1/file1	Started with one forward and one backward slash
/sdcarddir1/file1	No forward or backward slash
/sdcard1/dir1/file1	Invalid label

In order to maintain compatibility with the Simulator, the SDCard folder is created inside the userdata folder. File access points to userdata/SDCard when a PDMM SDCard path is used on the Simulator.

See Also:

- [File Name Warning & Limitations](#)

4.10.3.3 File Name Warning & Limitations

File names in the AKD PDMM or PCMM flash storage are case-sensitive and the SD card (FAT16 or FAT32) are not case-sensitive.

Storage	File System	Case-Sensitive
AKD PDMM / PCMM embedded flash	FFS3 (POSIX-like)	Yes
AKD PDMM / PCMM SD card	FAT16 or FAT32	No

For example, two files (`MyFile.txt` and `myfile.txt`) can exist in the same directory of the PDMM flash, but cannot exist in the same directory on the PDMM's SD card. If you copy two files (via backup operation or function) with the same name, but different upper/lower case letters, from the PDMM flash to the SD card, one of the files will be lost. **To prevent conflicts and to keep your application compatible across all platforms, use unique filenames and do not rely on case-sensitive filenames.**

4.10.4 *DEPRECATED* File Management Functions

The file management functions have been deprecated in favor of the Function Blocks in the following table.

Function Block	Deprecated Functions	Use
FileClose	F_CLOSE	Close an open file
FileCopy	F_COPY	Copy a file
FileDelete	F_DELETE	Remove a file
FileEOF	F_EOF	Test if the end of the file is reached in a file that is open for reading
FileExists	F_EXIST	Test if a file exists
FileOpenA	F_AOPEN	Create or open a file in append mode
FileOpenR	F_ROPEN	Open a file for reading
FileOpenW	F_WOPEN	Create or reset a file and open it for writing
FileReadBinData	FA_READ FB_READ	Read binary data from a file
FileReadLine	FM_READ	Read a string value from a text file
FileRename	F_RENAME	Rename a file
FileSeek	F_SEEK	Set the current position of a file
FileSize	F_GETSIZE	Get the size of a file
FileWriteBinData	FA_WRITE FB_WRITE	Write binary data to a file
FileWriteLine	FM_WRITE	Write a string value to a text file

4.10.5 File Management Function Examples

Following are several examples of how File Management functions may be used. The functions used include [FileOpenA](#), [FileClose](#), [FileOpenW](#), and [FileWriteLine](#).

```
// Determine if this is a UNIX-based or Windows operating system and set
the directory.
ID:= FileOpenA('C:\Program Files\Kollmorgen\Kollmorgen Automation
Suite\Sinope Runtime\Resources\http.conf');
IF ID > 0 THEN
    OutputFile := '\\' + FileName;
    FileClose(ID);
ELSE
    OutputFile := FileName;
END_IF;

IF (AddFileExt = true) THEN
    OutputFile := OutputFile + '.csv';
END_IF;
```

```
// Create a file for writing
FileID := FileOpenW (OutputFile);
IF (FileID = 0) THEN
    RETURN;
END_IF;
```

```
// Write header information to a file
HeaderStr := 'Time[ms],' + Header1 + '$R';
bStatus := FileWriteLine (FileID, HeaderStr);
IF (bStatus = false) THEN
    FileClose (FileID);
    FileID := 0;
    RETURN;
END_IF;
```

4.11 FilterOrder1 PLCopen

Function block - first order filter

4.11.1 Inputs

XIN : REAL	Input analog value
GAIN : REAL	Transformation gain

4.11.2 Outputs

XOUT : REAL	Output signal
-------------	---------------

4.11.3 Remarks

The operation performed is:

$$\text{Output} = (\text{Input} \times \text{Gain}) + (\text{OutputPrev} * (1-\text{Gain}))$$

The allowed range for the gain is [0.05 .. 1.0]

4.11.4 ST Language

Filt1 is a declared instance of FilterOrder1 function block.

```
Filt1 (rIn, rGain);
Signal := Filt1.Xout;
```

4.11.5 Example



Symbol	C...	# Dia...
Main/IN		1
Main/OUT		1



4.12 GETSYSINFO PLCopen

Function - Returns system information.

4.12.1 Inputs

INFO : DINT Identifier of the requested information

4.12.2 Outputs

Q : DINT Value of the requested information or 0 if error

4.12.3 Remarks

The INFO parameter can be one of the following predefined values:

Value	Definition
_SYSINFO_TRIGGER_MICROS	programmed cycle time in micro-seconds
_SYSINFO_TRIGGER_MS	programmed cycle time in milliseconds
_SYSINFO_CYCLETIME_MICROS	duration of the previous cycle in micro-seconds
_SYSINFO_CYCLETIME_MS	duration of the previous cycle in milliseconds
_SYSINFO_CYCLEMAX_MICROS	maximum detected cycle time in micro-seconds
_SYSINFO_CYCLEMAX_MS	maximum detected cycle time in milliseconds
_SYSINFO_CYCLESTAMP_MS	time stamp of the current cycle in milliseconds (OEM dependent)
_SYSINFO_CYCLEOVERFLOWS	number of detected cycle time overflows
_SYSINFO_CYCLECOUNT	counter of cycles
_SYSINFO_APPSTAMP	compiling date stamp of the application
_SYSINFO_CODECRC	CRC of the application code.
_SYSINFO_DATACRC	CRC of the application symbols.
_SYSINFO_FREEHEAP	Available space in memory heap (bytes)
_SYSINFO_DBSIZE	Space used in RAM (bytes)
_SYSINFO_ELAPSED	Seconds elapsed since startup
_SYSINFO_CHANGE_CYCLE	Indicates a cycle just after an On Line Change
_SYSINFO_WARMSTART	Non zero if RETAIN variables were loaded at the last start
_SYSINFO_NBLOCKED	Number of locked variables
_SYSINFO_NBBREAKPOINTS	Number of installed breakpoints
_SYSINFO_BIGENDIAN	Non zero if the runtime processor is big endian
_SYSINFO_DEMOAPP	Non zero if the application was compiled in DEMO mode

In FFLD language, the operation is executed only if the input rung (EN) is TRUE. The output rung (ENO) keeps the same value as the input rung.

In IL, the input must be loaded in the current result before calling the function.

4.12.4 ST Language

Q := GETSYSINFO (INFO);

4.12.5 FBD Language

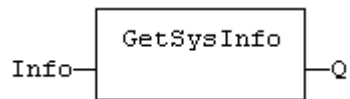

4.12.6 FFLD Language

(* The function is executed only if EN is TRUE *)

(* ENO keeps the same value as EN *)

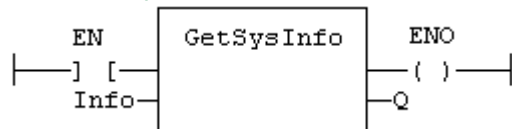

4.12.7 IL Language:

```
Op1: LD INFO
      GETSYSINFO
      ST Q
```

4.13 HYSTER PLCopen

Function Block - Hysteresis detection.

4.13.1 Inputs

XIN1 : REAL First input signal
 XIN2 : REAL Second input signal
 EPS : REAL Hysteresis

4.13.2 Outputs

Q : BOOL Detected hysteresis: TRUE if XIN1 becomes greater than XIN2+EPS and is not yet below XIN2-EPS

4.13.3 Remarks

The hysteresis is detected on the difference of XIN1 and XIN2 signals. In FFLD language, the input rung (EN) is used for enabling the block. The output rung is the Q output.

4.13.4 ST Language

(* MyHyst is a declared instance of HYSTER function block *)
 MyHyst (XIN1, XIN2, EPS);
 Q := MyHyst.Q;

4.13.5 FBD Language

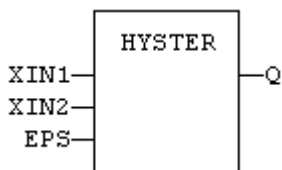

4.13.6 FFLD Language

(* The block is not called if EN is FALSE *)

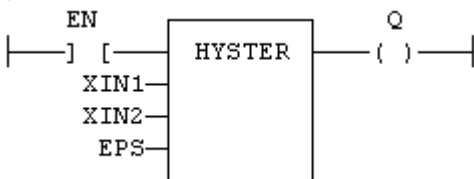

4.13.7 IL Language:

(* MyHyst is a declared instance of HYSTER function block *)
 Op1: CAL MyHyst (XIN1, XIN2, EPS)
 FFLD MyHyst.Q
 ST Q

See also

[AVERAGE](#) [INTEGRAL](#) [DERIVATE](#) [LIM_ALRM](#) [STACKINT](#)

4.14 INTEGRAL PLCopen

Function Block - Calculates the integral of a signal with respect to time.

The time unit is seconds. The output signal has the units of the input signal multiplied by seconds. The INTEGRAL block samples the input signal at a maximum rate of 1 millisecond.

4.14.1 Inputs

RUN : BOOL Run command: TRUE=integrate / FALSE=hold
 R1 : BOOL Overriding reset
 XIN : REAL Input signal
 X0 : REAL Initial value
 CYCLE : TIME Sampling period (must not be less than the target cycle timing)

4.14.2 Outputs

Q : DINT Running mode report: NOT (R1)
 XOUT : REAL Output signal

4.14.3 Remarks

In FFD language, the input rung is the RUN command. The output rung is the Q report status.

4.14.4 ST Language

```
(* MyIntg is a declared instance of INTEGRAL function block *)
MyIntg (RUN, R1, XIN, X0, CYCLE);
Q := MyIntg.Q;
XOUT := MyIntg.XOUT;
```

4.14.5 FBD Language

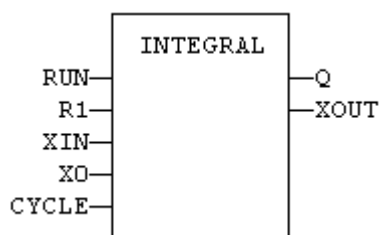

4.14.6 FFLD Language

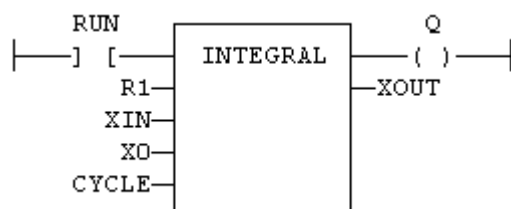

4.14.7 IL Language:

```
(* MyIntg is a declared instance of INTEGRAL function block *)  
Op1: CAL MyIntg (RUN, R1, XIN, X0, CYCLE)  
      FFLD MyIntg.Q  
      ST  Q  
      FFLD MyIntg.XOUT  
      ST  XOUT
```

See also

[AVERAGE](#) [DERIVATE](#) [LIM_ALARM](#) [HYSTER](#) [STACKINT](#)

4.15 LIFO PLCopen

Function block - Manages a "last in / first out" stack

4.15.1 Inputs

PUSH	BOOL	Push a new value (on rising edge)
POP	BOOL	Pop a new value (on rising edge)
RST	BOOL	Reset the list
NEXTIN	ANY	Value to be pushed
NEXTOUT	ANY	Value at the top of the stack - <i>updated after call!</i>
BUFFER	ANY	Array for storing values

4.15.2 Outputs

EMPTY	BOOL	TRUE if the stack is empty
OFLO	BOOL	TRUE if overflow on a PUSH command
COUNT	DINT	Number of values in the stack
PREAD	DINT	Index in the buffer of the top of the stack
PWRITE	DINT	Index in the buffer of the next push position

4.15.3 Remarks

NEXTIN, NEXTOUT and BUFFER must have the same data type *and cannot be STRING*. The NEXTOUT argument specifies a variable which is filled with the value at the top of the stack after the block is called.

Values are stored in the "BUFFER" array. Data is never shifted or reset. Only read and write pointers and pushed values are updated. The maximum size of the stack is the dimension of the array.

The first time the block is called, it remembers on which array it should work. If you call later the same instance with another BUFFER input, the call is considered as invalid and makes nothing. Outputs reports an empty stack in this case.

In FFLD language, input rung is the PUSH input. The output rung is the EMPTY output.

4.15.4 ST Language

```
(* MyLIFO is a declared instance of LIFO function block *)
MyLIFO (PUSH, POP, RST, NEXTIN, NEXTOUT, BUFFER);
EMPTY := MyLIFO.EMPTY;
OFLO := MyLIFO.OFLO;
COUNT := MyLIFO.COUNT;
PREAD := MyLIFO.PREAD;
PWRITE := MyLIFO.PWRITE;
```

4.15.5 FBD Language

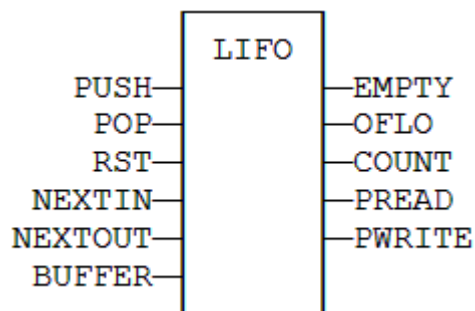

4.15.6 FFLD Language

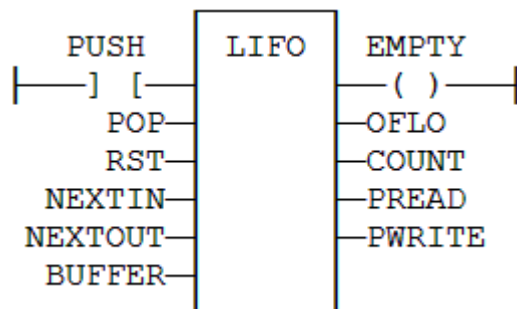

4.15.7 IL Language

```
(* MyLIFO is a declared instance of LIFO function block *)
Op1: CAL MyLIFO (PUSH, POP, RST, NEXTIN, NEXTOUT, BUFFER)
FFLD MyLIFO.EMPTY
ST EMPTY
FFLD MyLIFO.OFLO
ST OFLO
FFLD MyLIFO.COUNT
ST COUNT
FFLD MyLIFO.PREAD
ST PREAD
FFLD MyLIFO.PWRITE
ST PWRITE
```

See also

[FIFO](#)

4.16 LIM_ALARM PLCopen

Function Block - Detects High and Low limits of a signal with hysteresis.

4.16.1 Inputs

H : REAL Value of the High limit
 X : REAL Input signal
 L : REAL Value of the Low limit
 EPS : REAL Value of the hysteresis

4.16.2 Outputs

QH : BOOL TRUE if the signal exceeds the High limit
 Q : BOOL TRUE if the signal exceeds one of the limits (equals to QH OR QL)
 QL : BOOL TRUE if the signal exceeds the Low limit

4.16.3 Remarks

In FFLD language, the input rung (EN) is used for enabling the block. The output rung is the QH output.

4.16.4 ST Language

```
(* MyAlarm is a declared instance of LIM_ALARM function block *)
MyAlarm (H, X, L, EPS);
QH := MyAlarm.QH;
Q := MyAlarm.Q;
QL := MyAlarm.QL;
```

4.16.5 FBD Language

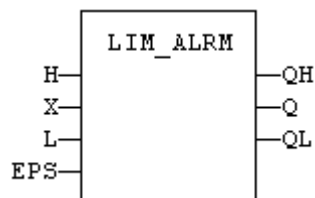

4.16.6 FFLD Language

(* The block is not called if EN is FALSE *)

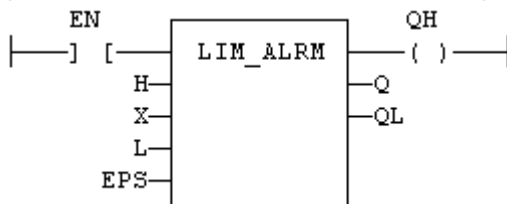

4.16.7 IL Language:

```
(* MyAlarm is a declared instance of LIM_ALRM function block *)  
Op1: CAL MyAlarm (H, X, L, EPS)  
    FFLD MyAlarm.QH  
    ST QH  
    FFLD MyAlarm.Q  
    ST Q  
    FFLD MyAlarm.QL  
    ST QL
```

See also

[ALARM_A](#) [ALARM_M](#)

4.17 LogFileCSV

Function block - Generate a log file in CSV format for a list of variables

4.17.1 Inputs

LOG : BOOL	Variables are saved on any rising edge of this input
RST : BOOL	Reset the contents of the CSV file
LIST : DINT	ID of the list of variables to log (use VLID function)
PATH : STRING	Path name of the CSV file

4.17.2 Outputs

Q : BOOL	TRUE if the requested operation has been performed without error
ERR : DINT	Error report for the last requested operation (0 is OK)

IMPORTANT

Calling this function can lead to missing several PLC cycles. Files are opened and closed directly by the target's Operating System. Opening some files may be dangerous for system safety and integrity. The number of open files may be limited by the target system.

NOTE

- Opening a file may be unsuccessful (invalid path or file name, too many open files...) Your application has to process such error cases in a safe way.
- File management may be not available on some targets. Please refer to OEM instructions for further details about available features.
- Valid paths for storing files depend on the target implementation. Please refer to OEM instructions for further details about available paths.

4.17.3 Remarks

This function enables to log values of a list of variables in a CSV file. On each rising edge of the LOG input, one more line of values is added to the file. There is one column for each variable, as they are defined in the list.

The list of variables is prepared using the KAS IDE or a text editor. Use the [VLID](#) function to get the identifier of the list.

On a rising edge of the RST command, the file is emptied.

When a LOG or RST command is requested, the Q output is set to TRUE if successful.

In case of error, a report is given in the ERR output. Possible error values are:

- 1 = Cannot reset file on a RST command
- 2 = Cannot open file for data storing on a LOG command
- 3 = Embedded lists are not supported by the runtime
- 4 = Invalid list ID
- 5 = Error while writing to file

Combined with real time clock management functions, this block provides a very easy way to generate a periodical log file. The following example shows a list and a program that log values

everyday at 14h23m (2:23 pm) (see call out )

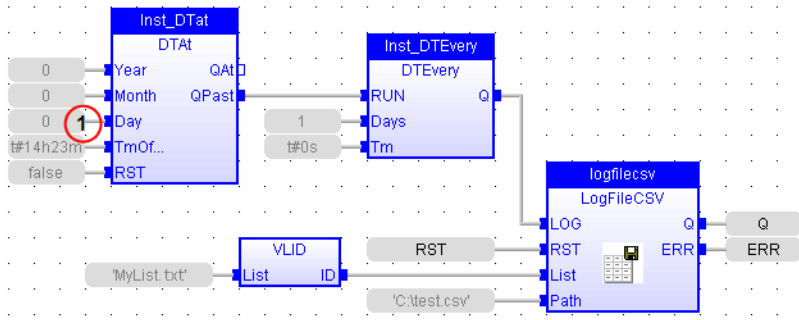

4.17.4 ST Language

```
(* MyLOG is a declared instance of LogFileCSV function block *)
MyLOG (b_LOG, RST, LIST, PATH);
Q := MyLOG.Q;
ERR := MyLog.ERR;
```

4.17.5 FBD Language

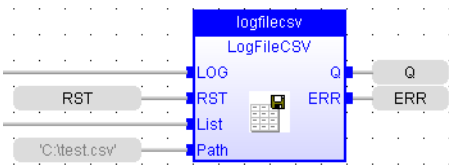

4.17.6 FFLD Language

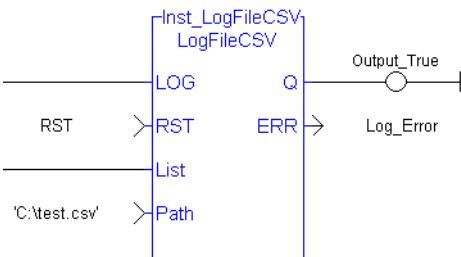

4.17.7 IL Language

```
(* MyLOG is a declared instance of LogFileCSV function block *)  
Op1: CAL MyLOG (b_LOG, RST, LIST, PATH);  
FFLD MyLOG.Q  
ST Q  
FFLD MyLog.ERR  
ST ERR
```

See also

[VLID](#)

4.18 PID PLCopen

Function Block - PID loop

4.18.1 Inputs

Input	Type	Description
AUTO	BOOL	TRUE = normal mode , FALSE = manual mode.
PV	REAL	Process value.
SP	REAL	Set point.
Xout_Manu	REAL	Output value in manual mode.
KP	REAL	Gain.
TI	REAL	Integration time factor. A value of zero will stop the integrator and freeze Xout I at the previous sample's calculated value.
TD	REAL	Derivation factor.
TS	TIME	Sampling period.
XMIN	REAL	Minimum allowed output value.
XMAX	REAL	Maximum output value.
I_SEL	BOOL	If FALSE, the integrated value is ignored.
INT_HOLD	BOOL	If TRUE, the integrated value is frozen.
I_ITL_ON	BOOL	If TRUE, the integrated value is reset to I_ITLVAL.
I_ITLVAL	REAL	Reset value for integration when I_ITL_ON is TRUE.
DEADB_ERR	REAL	Hysteresis on PV. PV will be considered as unchanged if greater than (PVprev - DEADBAND_W) and less that (PRprev + DEADBAND_W).
FFD	REAL	Disturbance value on output.

4.18.2 Outputs

Output	Type	Description
Xout	REAL	Output command value.
ER	REAL	Last calculated error.
Xout_P	REAL	Last calculated proportional value.
Xout_I	REAL	Last calculated integrated value.
Xout_D	REAL	Last calculated derivated value.
Xout_HLM	BOOL	TRUE if the output value is saturated to XMIN.
Xout_LLM	BOOL	TRUE if the output value is saturated to XMAX.

4.18.3 Diagram

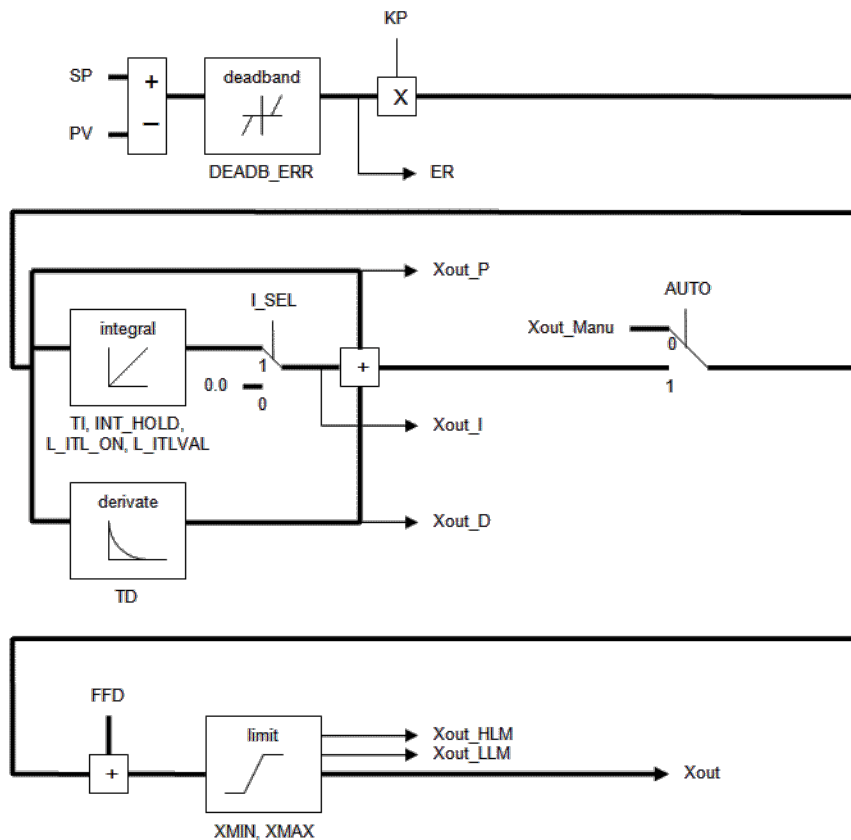

4.18.4 Remarks

- It is important for the stability of the control that the TS sampling period is much bigger than the cycle time.
- Output of the PID block always starts with zero. The value will vary per the inputs provided upon further cycle executions.
- The output rung has the same value as the AUTO input, corresponding to the input rung, in the FFLD language.

4.18.5 ST Language

```
(* MyPID is a declared instance of PID function block *)
MyPID (AUTO, PV, SP, XOUT_MANU, KP, TI, TD, TS, XMIN, XMAX, I_SEL, I_ITL_ON, I_ITLVAL, DEADB_ERR, FFD);
XOUT := MyPID.XOUT;
ER := MyPID.ER;
XOUT_P := MyPID.XOUT_P;
XOUT_I := MyPID.XOUT_I;
XOUT_D := MyPID.XOUT_D;
XOUT_HLM := MyPID.XOUT_HLM;
XOUT_LLM := MyPID.XOUT_LLM;
```

4.18.6 FBD Language

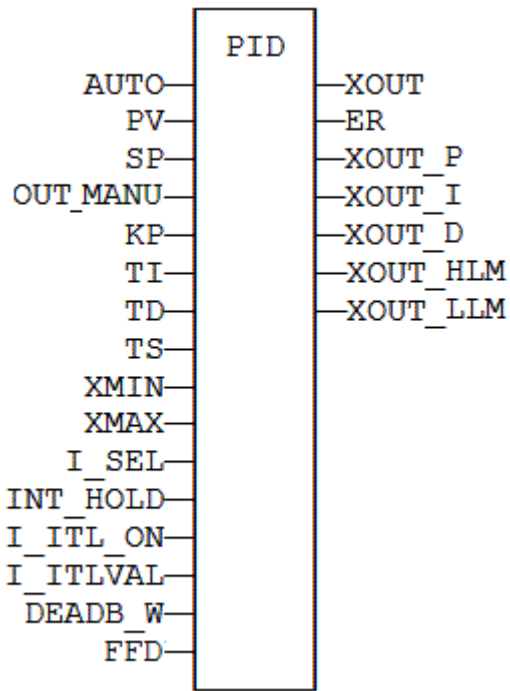

4.18.7 FFLD Language

(* ENO has the same state as the input rung *)

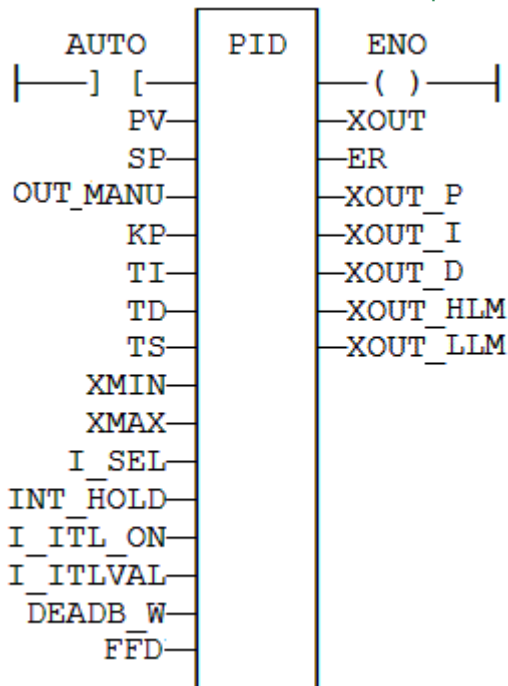

4.18.8 IL Language

(* MyPID is a declared instance of PID function block *)

```
Op1:    CAL MyPID (AUTO, PV, SP, XOUT_MANU, KP, TI, TD, TS, XMIN, XMAX, I_
SEL, I_ITL_ON, I_ITLVAL, DEADB_ERR, FFD)
        FFLD MyPID.XOUT
        ST  XOUT
```

```
FFLD MyPID.ER
ST ER
FFLD MyPID.XOUT_P
ST XOUT_P
FFLD MyPID.XOUT_I
ST XOUT_I
FFLD MyPID.XOUT_D
ST XOUT_D
FFLD MyPID.XOUT_HLM
ST XOUT_HLM
FFLD MyPID.XOUT_LLM
ST XOUT_LLM
```

4.19 PWM PLCopen

Function block - generate a PWM signal.

4.19.1 Inputs

XIN : REAL	Input analog value
XinMin : REAL	Minimum input value
XinMax : REAL	Maximum input value
MinPulse : TIME	Minimum pulse time on output
Period : TIME	Period of the output signal

4.19.2 Outputs

Q : BOOL	Blinking PWM signal
----------	---------------------

4.19.3 Remarks

The input value is truncated to [XinMin .. XinMax] interval. XinMax must be greater than XinMin.

The signal is TRUE during:

$$(Xin - XinMin) * Period / (XinMax - XinMin)$$

4.19.4 ST Language

PWM1 is a declared instance of PWM function block.

```
PWM1 (rIn, rInMin, rInMax, tMinPulse, tPeriod);
Signal := PWM1.Q;
```

4.19.5 Example

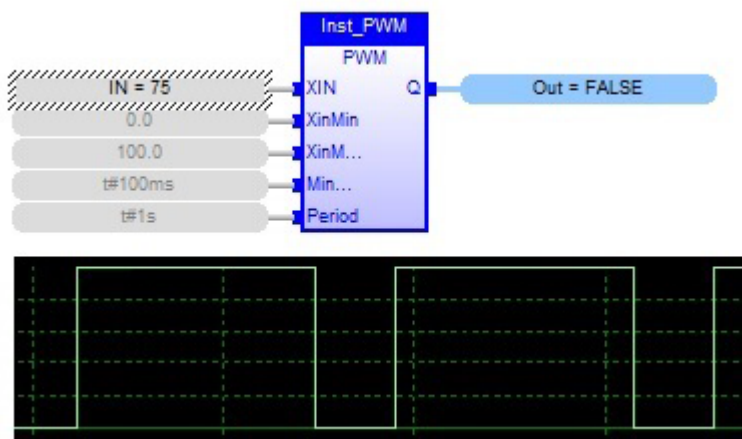

4.20 RAMP PLCopen

Function block - Limit the ascendance or descendance of a signal

4.20.1 Inputs

IN : REAL Input signal
 ASC : REAL Maximum ascendance during time base
 DSC : REAL Maximum descendance during time base
 TM : TIME Time base
 RST : BOOL Reset

4.20.2 Outputs

OUT : REAL Ramp signal

4.20.3 Time diagram

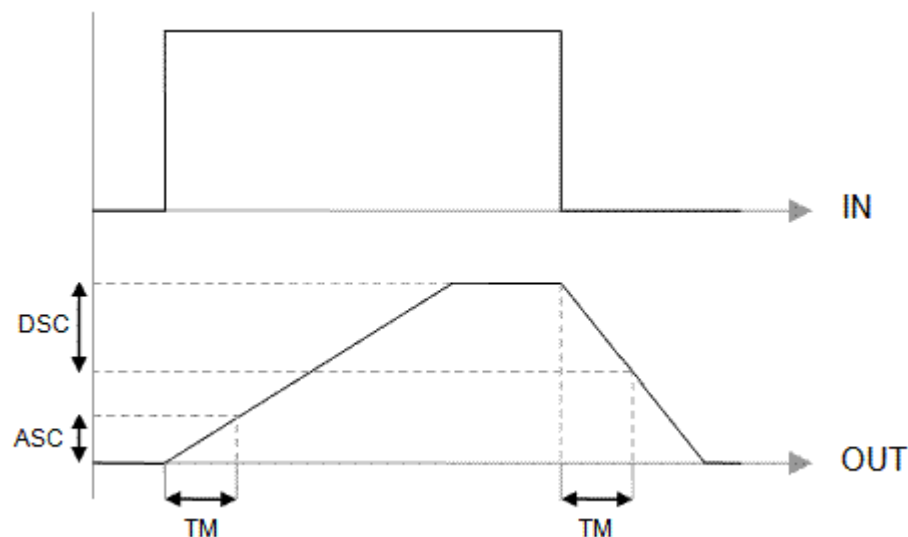

4.20.4 Remarks

Parameters are not updated constantly. They are taken into account when only:

- the first time the block is called
- when the reset input (RST) is TRUE

In these two situations, the output is set to the value of IN input.

ASC and DSC give the maximum ascendant and descendant growth during the TB time base. Both must be expressed as positive numbers.

In FFLD language, the operation is executed only if the input rung (EN) is TRUE. The output rung (ENO) keeps the same value as the input rung.

4.20.5 ST Language

```
(* MyRamp is a declared instance of RAMP function block *)
MyRamp (IN, ASC, DSC, TM, RST);
OUT := MyBlinker.OUT;
```

4.20.6 FBD Language

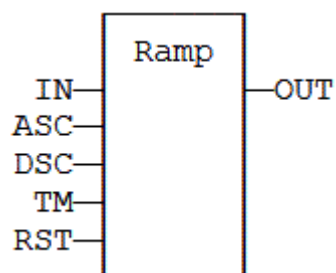

4.20.7 FFLD Language

(* The function is executed only if EN is TRUE *)

(* ENO keeps the same value as EN *)

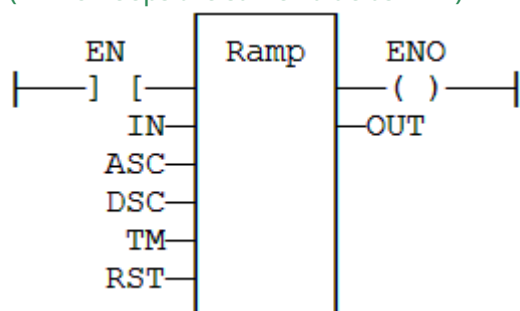

4.20.8 IL Language

```
(* MyRamp is a declared instance of RAMP function block *)
Op1: CAL
MyRamp (IN, ASC, DSC, TM, RST)
FFLD MyBlinker.OUT
ST OUT
```

4.21 Real Time Clock Management Functions

The following functions read the real time clock of the target system:

DTCurDate	Get current date stamp
DTCurTime	Get current time stamp
DTDay	Get day from date stamp
DTMonth	Get month from date stamp
DTYear	Get year from date stamp
DTSec	Get seconds from time stamp
DTMin	Get minutes from time stamp
DTHour	Get hours from time stamp
DTMs	Get milliseconds from time stamp

The following functions format the current date/time to a string:

DAY_TIME	With predefined format
DTFORMAT	With custom format

The following functions are used for triggering operations:

DTAt	Pulse signal at the given date/time
DTEvery	Pulse signal with long period

! IMPORTANT

The real-time clock may not be available on all controller hardware models. Please consult the controller hardware specifications for real-time clock availability.

DAY_TIME: get current date or time

```
Q := DAY_TIME (SEL);
```

SEL : DINT specifies the wished information (see below)

Q : STRING wished information formatted on a string

Possible values of SEL input

- 1 current time - format: 'HH:MM:SS'
- 2 day of the week
- 0 (default) current date - format: 'YYYY/MM/DD'

DTCURDATE: get current date stamp

```
Q := DTCurDate ();
```

Q : DINT numerical stamp representing the current date

DTCURTIME: get current time stamp

```
Q := DTCurTime ();
```

Q : DINT numerical stamp representing the current time of the day

DTYEAR: extract the year from a date stamp

```
Q := DTYear (iDate);
```

IDATE : DINT numerical stamp representing a date. This is output of DTCURDATE.

Q : DINT year of the date (ex: 2004)

DTMONTH: extract the month from a date stamp

```
Q := DTMonth (iDate);
```

IDATE : DINT numerical stamp representing a date. This is output of DTCURDATE.
 Q : DINT month of the date (1..12)

DTDAY: extract the day of the month from a date stamp

Q := DTDAY (iDate);

IDATE : DINT numerical stamp representing a date. This is output of DTCURDATE.
 Q : DINT day of the month of the date (1..31)

DTHOUR: extract the hours from a time stamp

Q := DTHour (iTime);

ITIME : DINT numerical stamp representing a time. This is output of DTCURDATE.
 Q : DINT Hours of the time (0..23)

DTMIN: extract the minutes from a time stamp

Q := DTMin (iTime);

ITIME : DINT numerical stamp representing a time. This is output of DTCURDATE.
 Q : DINT Minutes of the time (0..59)

DTSEC: extract the seconds from a time stamp

Q := DTSec (iTime);

ITIME : DINT numerical stamp representing a time. This is output of DTCURDATE.
 Q : DINT Seconds of the time (0..59)

DTMS: extract the milliseconds from a time stamp

Q := DTMs (iTime);

ITIME : DINT numerical stamp representing a time. This is output of DTCURDATE.
 Q : DINT Milliseconds of the time (0..999)

4.21.1 DAY_TIME PLCopen

Function - Format the current date/time to a string.

4.21.1.1 Inputs

SEL : DINT Format selector

4.21.1.2 Outputs

Q : STRING String containing formatted date or time

ⓘ IMPORTANT

The real-time clock may not be available on all controller hardware models. Please consult the controller hardware specifications for real-time clock availability.

4.21.1.3 Remarks

Possible values of the SEL input are:

- 1 current time - format: 'HH:MM:SS'
- 2 day of the week
- 0 (default) current date - format: 'YYYY/MM/DD'

In FFLD language, the operation is executed only if the input rung (EN) is TRUE. The output rung (ENO) keeps the same value as the input rung.

4.21.1.4 ST Language

Q := DAY_TIME (SEL);

4.21.1.5 FBD Language

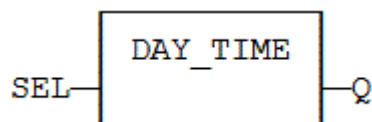

4.21.1.6 FFLD Language

(* The function is executed only if EN is TRUE *)
 (* ENO keeps the same value as EN *)

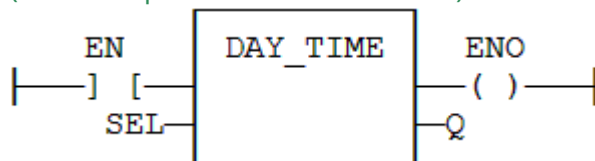

4.21.1.7 IL Language

Op1: LD SEL
 DAY_TIME
 ST Q

See also

[DTFORMAT](#)

4.21.2 DTFORMAT PLCopen

Function - Format the current date/time to a string with a custom format.

4.21.2.1 Inputs

FMT: STRING Format string

4.21.2.2 Outputs

Q : STRING String containing formatted date or time

! IMPORTANT

The real-time clock may not be available on all controller hardware models. Please consult the controller hardware specifications for real-time clock availability.

4.21.2.3 Remarks

The format string may contain any character. Some special markers beginning with the '%' character indicates a date/time information:

- %Y Year including century (e.g. 2006)
- %y Year without century (e.g. 06)
- %m Month (1..12)
- %d Day of the month (1..31)
- %H Hours (0..23)
- %M Minutes (0..59)
- %S Seconds (0..59)

Example

```
(* let's say we are at July 04th 2006, 18:45:20 *)
  Q := DTFORMAT ('Today is %Y/%m/%d - %H:%M:%S');
(* Q is 'Today is 2006/07/04 - 18:45:20 *)
```

4.21.2.4 ST Language

```
Q := DTFORMAT (FMT);
```

4.21.2.5 FBD Language

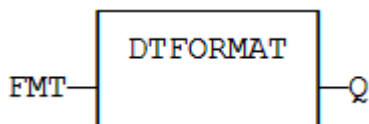

4.21.2.6 FFLD Language

(* The function is executed only if EN is TRUE *)
 (* ENO keeps the same value as EN *)

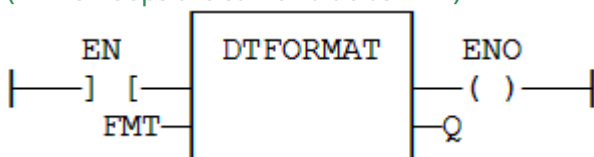

4.21.2.7 IL Language

```
Op1: LD FMT  
DTFORMAT  
ST Q
```

See also

[DAY_TIME](#)

4.21.3 DTAT PLCopen

Function Block - Generate a pulse at given date and time

4.21.3.1 Inputs

YEAR : DINT Wished year (e.g. 2006)
 MONTH : DINT Wished month (1 = January)
 DAY : DINT Wished day (1 to 31)
 TMOFDAY : TIME Wished time
 RST : BOOL Reset command

4.21.3.2 Outputs

QAT : BOOL Pulse signal
 QPAST : BOOL True if elapsed

! IMPORTANT

The real-time clock may not be available on all controller hardware models. Please consult the controller hardware specifications for real-time clock availability.

4.21.3.3 Remarks

Parameters are not updated constantly. They are taken into account when only:

- the first time the block is called
- when the reset input (RST) is TRUE

In these two situations, the outputs are reset to FALSE.

The first time the block is called with RST=FALSE and the specified date/stamp is passed, the output QPAST is set to TRUE, and the output QAT is set to TRUE for one cycle only (pulse signal).

Highest units are ignored if set to 0. For instance, if arguments are "year=0, month=0, day = 3, tmofday=t#10h" then the block will trigger on the next 3rd day of the month at 10h.

In FFLD language, the block is activated only if the input rung is TRUE..

4.21.3.4 ST Language

(* MyDTAT is a declared instance of DTAT function block *)

```
MyDTAT (YEAR, MONTH, DAY, TMOFDAY, RST);
QAT := MyDTAT.QAT;
QPAST := MyDTATA.QPAST;
```

4.21.3.5 FBD Language

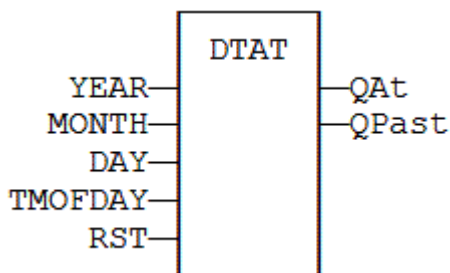

4.21.3.6 FFLD Language

(* Called only if EN is TRUE *)

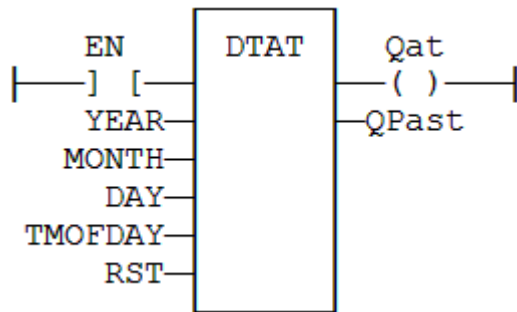

4.21.3.7 IL Language:

(* MyDTAT is a declared instance of DTAT function block *)

Op1: CAL MyDTAT (YEAR, MONTH, DAY, TMOFDAY, RST)

FFLD MyDTAT.QAT

ST QAT

FFLD MyDTATA.QPAST

ST QPAST

See also

[DTEVERY](#) Real time clock functions

4.21.4 DTEVERY PLCopen

Function Block - Generate a pulse signal with long period

4.21.4.1 Inputs

RUN : DINT Enabling command
 DAYS : DINT Period : number of days
 TM : TIME Rest of the period (if not a multiple of 24h)

4.21.4.2 Outputs

Q : BOOL Pulse signal

4.21.4.3 Remarks

This block provides a pulse signal with a period of more than 24h. The period is expressed as:
 DAYS * 24h + TM

For instance, specifying DAYS=1 and TM=6h means a period of 30 hours.

4.21.4.4 ST Language

(* MyDTEVERY is a declared instance of DTEVERY function block *)

MyDTEVERY (RUN DAYS, TM);

Q := MyDTEVERY.Q;

4.21.4.5 FBD Language

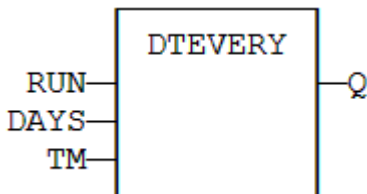

4.21.4.6 FFLD Language

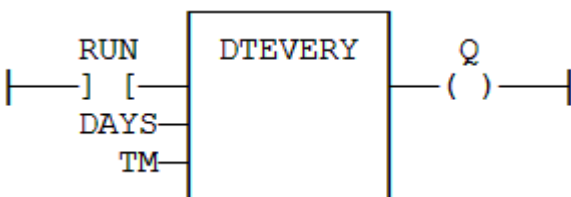

4.21.4.7 IL Language:

(* MyDTEVERY is a declared instance of DTEVERY function block *)

Op1: CAL MyDTEVERY (RUN DAYS, TM)

FFLD MyDTEVERY.Q

ST Q

See also

[DTAT Real time clock functions](#)

4.22 Serializeln

4.22.1 Description

Extract the value of a variable from a binary frame. This function is commonly used for extracting data from a communication frame in binary format.

In LD language, the operation is executed only if the input rung (EN) is TRUE. The output rung (ENO) keeps the same value as the input rung.

TIP

This function is not available in IL language.

The FRAME input must fit the input position and data size. If the value cannot be safely extracted, the function returns 0. The DATA input must be directly connected to a variable, and cannot be a constant or complex expression. This variable will be forced with the extracted value.

The function extracts the following number of bytes from the source frame:

1 byte	BOOL, SINT, USINT and BYTE variables
2 bytes	INT, UINT and WORD variables
4 bytes	DINT, UDINT, DWORD and REAL variables
8 bytes	LINT and LREAL variables

IMPORTANT

The function cannot be used to serialize STRING variables.

The function returns the position in the source frame, after the extracted data. Thus the return value can be used as a position for the next serialization.

4.22.2 Arguments

4.22.2.1 Input

En	Description	Execute the function
	Data type	BOOL
	Range	[0,1]
	Unit	N/A
	Default	—
Frame[]	Description	Source buffer - must be an array.
	Data type	USINT
	Range	[0,+65535]
	Unit	N/A
	Default	N/A
Data	Description	Destination variable to be copied
	Data type	any except STRING

	Range	—
	Unit	N/A
	Default	—
Pos	Description	Position in the source buffer
	Data type	DINT
	Range	[0,+65535]
	Unit	N/A
	Default	N/A
BigEndian	Description	TRUE if the frame is encoded with Big Endian format.
	Data type	BOOL
	Range	?
	Unit	?
	Default	?

4.22.2.2 Output

OK	Description	Returns true when the function successfully executes. See Function - General rules .
	Data type	BOOL
	Unit	N/A
NextPos	Description	Position in the source buffer after the extracted data. 0 in case of error (invalid position / buffer size).
	Data type	DINT
	Unit	N/A

4.22.3 Examples

4.22.3.1 Structured Text

```
NextPos := SerializeIn(Frame[] (*USINT*), @Data (*ANY*), Pos (*DINT*),
BigEndian (*BOOL*)); //Read the position
```

4.23 SerializeOut PLCopen

4.23.1 Description

This function copies the value of a variable to a binary frame. This function is commonly used for building a communication frame in binary format.

In LD language, the operation is executed only if the input rung (EN) is TRUE. The output rung (ENO) keeps the same value as the input rung.

NOTE

This function is not available in IL language.

The FRAME input must be an array large enough to receive the data. If the data cannot be safely copied to the destination buffer, the function returns 0.

The function copies the following number of bytes to the destination frame:

1 byte	BOOL, SINT, USINT and BYTE variables
2 bytes	INT, UINT and WORD variables
4 bytes	DINT, UDINT, DWORD and REAL variables
8 bytes	LINT and LREAL variables

! IMPORTANT

The function cannot be used to serialize STRING variables.

The function returns the position in the destination frame, after the copied data. Thus the return value can be used as a position for the next serialization.

4.23.2 Arguments

4.23.2.1 Input

En	Description	Execute the function
	Data type	BOOL
	Range	[0,1]
	Unit	N/A
	Default	—
Frame[]	Description	Destination buffer - must be an array.
	Data type	USINT
	Range	[0,+65535]
	Unit	N/A
	Default	—
Data	Description	Source variable to be copied
	Data type	any except STRING
	Range	—

	Unit	N/A
	Default	—
Pos	Description	Position in the destination buffer
	Data type	DINT
	Range	[0,+65535]
	Unit	N/A
	Default	—
BigEndian	Description	TRUE if the frame is encoded with Big Endian format.
	Data type	BOOL
	Range	[0,1]
	Unit	N/A
	Default	—

4.23.2.2 Output

OK	Description	Returns true when the function successfully executes. See Function - General rules .
	Data type	BOOL
	Unit	N/A
NextPos	Description	Position in the destination buffer after the copied data. 0 in case of error (invalid position / buffer size).
	Data type	DINT
	Unit	N/A

4.23.3 Examples

4.23.3.1 Structured Text

```
NextPos := SerializeOut(Frame[] (*USINT*), Data(*ANY*), Pos(*DINT*),
BigEndian(*BOOL*)); //Read the position
```

4.24 SigID PLCopen

Function - Get the identifier of a "Signal" resource

4.24.1 Inputs

SIGNAL : STRING Name of the signal resource - *must be a constant value!*
 COL : STRING Name of the column within the signal resource - *must be a constant value!*

4.24.2 Outputs

ID : DINT ID of the signal - to be passed to other blocks

4.24.3 Remarks

Some blocks have arguments that refer to a "signal" resource. For all these blocks, the signal argument is materialized by a numerical identifier. This function enables you to get the identifier of a signal defined as a resource.

4.24.4 ST Language

```
ID := SigID ('MySignal', 'FirstColumn');
```

4.24.5 FBD Language

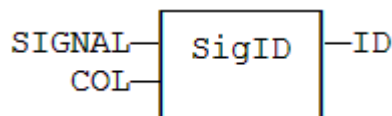

4.24.6 FFLD Language

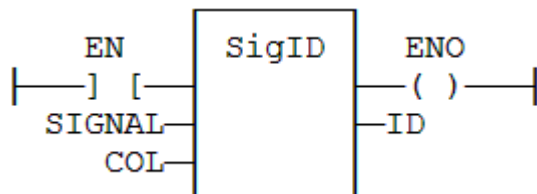

4.24.7 IL Language

```
Op1: LD 'MySignal'  
      SigID 'FirstColumn'  
      ST ID
```

See also

[SigPlay](#) [SigScale](#)

4.25 SigPlay PLCopen

Function block - Generate a signal defined in a resource

4.25.1 Inputs

IN : BOOL	Triggering command
ID : DINT	ID of the signal resource, provided by SigID function
RST : BOOL	Reset command
TM : TIME	Minimum time in between two changes of the output

4.25.2 Outputs

Q : BOOL	TRUE when the signal is finished
OUT : REAL	Generated signal
ET : TIME	Elapsed time

4.25.3 Remarks

The "ID" argument is the identifier of the "signal" resource. Use the [SigID](#) function to get this value.

The "IN" argument is used as a "Play / Pause" command to play the signal. The signal is not reset to the beginning when IN becomes FALSE. Instead, use the "RST" input that resets the signal and forces the OUT output to 0.

The "TM" input specifies the minimum amount of time in between two changes of the output signal. This parameter is ignored if less than the cycle scan time.

This function block includes its own timer. Alternatively, you can use the [SigScale](#) function if you want to trigger the signal using a specific timer.

4.25.4 ST Language

Q := SigScale (ID, IN);

4.25.5 FBD Language

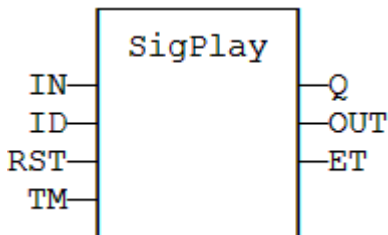

4.25.6 FFLD Language

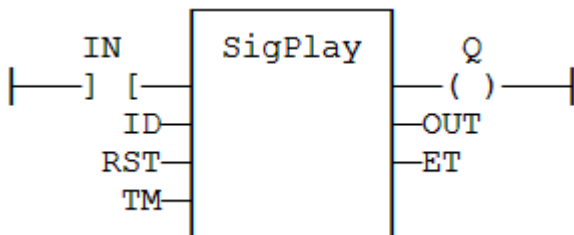

4.25.7 IL Language

Op1: FFLD IN
SigScale ID
ST Q

See also

[SigScale](#) [SigID](#)

4.26 SigScale PLCopen

Function - Get a point from a "Signal" resource

4.26.1 Inputs

ID : DINT ID of the signal resource, provided by [SigID](#) function
 IN : TIME Time (X) coordinate of the wished point within the signal resource

4.26.2 Outputs

Q : REAL Value (Y) coordinate of the point in the signal

4.26.3 Remarks

The "ID" argument is the identifier of the "signal" resource. Use the [SigID](#) function to get this value. This function converts a time value to an analog value such as defined in the signal resource. This function can be used instead of [SigPlay](#) function block if you want to trigger the signal using a specific timer.

4.26.4 ST Language

Q := SigScale (ID, IN);

4.26.5 FBD Language

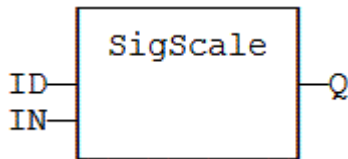

4.26.6 FFLD Language

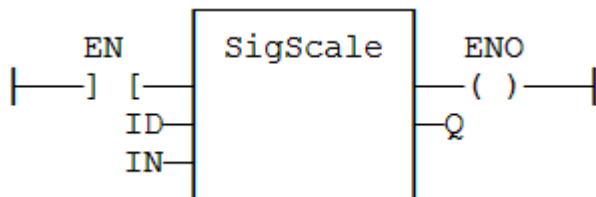

4.26.7 IL Language

Op1: LD IN
 SigScale ID
 ST Q

See also

[SigPlay](#) [SigID](#)

4.27 STACKINT PLCopen

Function Block - Manages a stack of DINT integers.

4.27.1 Inputs

PUSH : BOOL	Command: when changing from FALSE to TRUE, the value of IN is pushed on the stack
POP : BOOL	Pop command: when changing from FALSE to TRUE, deletes the top of the stack
R1 : BOOL	Reset command: if TRUE, the stack is emptied and its size is set to N
IN : DINT	Value to be pushed on a rising pulse of PUSH
N : DINT	maximum stack size - cannot exceed 128

4.27.2 Outputs

EMPTY : BOOL	TRUE if the stack is empty
OFLO : BOOL	TRUE if the stack is full
OUT : DINT	value at the top of the stack

4.27.3 Remarks

Push and pop operations are performed on rising pulse of PUSH and POP inputs. In FFLD language, the input rung is the PUSH command. The output rung is the EMPTY output.

The specified size (N) is taken into account only when the R1 (reset) input is TRUE.

4.27.4 ST Language

(* MyStack is a declared instance of STACKINT function block *)

```
MyStack (PUSH, POP, R1, IN, N);
EMPTY := MyStack.EMPTY;
OFLO := MyStack.OFLO;
OUT := MyStack.OUT;
```

4.27.5 FBD Language

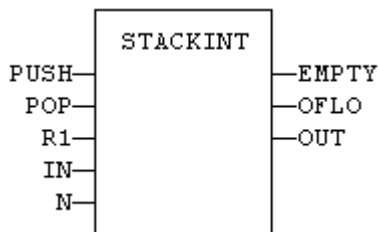

4.27.6 FFLD Language

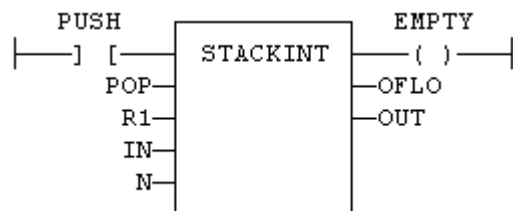

4.27.7 IL Language

(* MyStack is a declared instance of STACKINT function block *)

Op1: CAL MyStack (PUSH, POP, R1, IN, N)

FFLD MyStack.EMPTY

ST EMPTY

FFLD MyStack.OFLO

ST OFLO

FFLD MyStack.OUT

ST OUT

See also

[AVERAGE](#) [INTEGRAL](#) [DERIVATE](#) [LIM_ALRM](#) [HYSTER](#)

4.28 SurfLin PLCopen

Function block- Linear interpolation on a surface.

4.28.1 Inputs

X : REAL X coordinate of the point to be interpolated.

Y : REAL Y coordinate of the point to be interpolated.

XAxis : REAL[] X coordinates of the known points of the X axis.

YAxis : REAL[] Y coordinates of the known points of the Y axis.

ZVal : REAL[,] Z coordinate of the points defined by the axis.

4.28.2 Outputs

Z : REAL Interpolated Z value corresponding to the X,Y input point

OK : BOOL TRUE if successful.

ERR : DINT Error code if failed - 0 if OK.

4.28.3 Remarks

This function performs linear surface interpolation in between a list of points defined in XAxis and YAxis single dimension arrays. The output Z value is an interpolation of the Z values of the four rounding points defined in the axis. Z values of defined points are passed in the ZVal matrix (two dimension array).

ZVal dimensions must be understood as: ZVal [iX , iY]

Values in X and Y axis must be sorted from the smallest to the biggest. There must be at least two points defined in each axis. ZVal must fit the dimension of XAxis and YAxis arrays. For instance:

XAxis : ARRAY [0..2] of REAL;

YAxis : ARRAY [0.3] of REAL;

ZVal : ARRAY [0..2,0..3] of REAL;

In case the input point is outside the rectangle defined by XAxis and YAxis limits, the Z output is bound to the corresponding value and an error is reported.

The ERR output gives the cause of the error if the function fails:

Error Code	Meaning
0	OK
1	Invalid dimension of input arrays
2	Invalid points for the X axis
3	Invalid points for the Y axis
4	X,Y point is out of the defined axis

4.29 VLID PLCopen

Function - Get the identifier of an embedded list of variables

4.29.1 Inputs

FILE : STRING Path name of the .TXT list file - *must be a constant value!*

4.29.2 Outputs

ID : DINT ID of the list - to be passed to other blocks

4.29.3 Remarks

Some blocks have arguments that refer to a list of variables. For all these blocks, the "list" argument is materialized by a numerical identifier. This function enables you to get the identifier of a list of variables.

Embedded lists of variables are simple ".TXT" text files with one variable name per line (note that you can only declare global variable).

Lists must contain single variables only. Items of arrays and structures must be specified one by one. The length of the list is not limited by the system.

! IMPORTANT

List files are read at compiling time and are embedded into the downloaded application code. This implies that a modification performed in the list file after downloading will not be taken into account by the application.

4.29.4 ST Language

ID := VLID ('MyFile.txt');

4.29.5 FBD Language



4.29.6 FFLD Language

(* The function is executed only if EN is TRUE *)

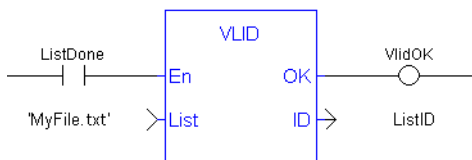

4.29.7 IL Language

Op1: LD 'MyFile.txt'

VLID COL

ST ID

About KOLLMORGEN

Kollmorgen is a leading provider of motion systems and components for machine builders. Through world-class knowledge in motion, industry-leading quality and deep expertise in linking and integrating standard and custom products, Kollmorgen delivers breakthrough solutions that are unmatched in performance, reliability and ease-of-use, giving machine builders an irrefutable marketplace advantage.



Join the [Kollmorgen Developer Network](#) for product support. Ask the community questions, search the knowledge base for answers, get downloads, and suggest improvements.

North America

KOLLMORGEN

201 West Rock Road
Radford, VA 24141, USA

Web: www.kollmorgen.com
Mail: support@kollmorgen.com
Tel.: +1 - 540 - 633 - 3545
Fax: +1 - 540 - 639 - 4162

Europe

KOLLMORGEN Europe GmbH

Pempelfurtstr. 1
40880 Ratingen, Germany

Web: www.kollmorgen.com
Mail: technik@kollmorgen.com
Tel.: +49 - 2102 - 9394 - 0
Fax: +49 - 2102 - 9394 - 3155

South America

KOLLMORGEN

Avenida João Paulo Ablas, 2970
Jardim da Glória, Cotia - SP
CEP 06711-250, Brazil

Web: www.kollmorgen.com
Mail: contato@kollmorgen.com
Tel.: +55 11 4615-6300

China and SEA

KOLLMORGEN

Room 302, Building 5, Lihpao Plaza,
88 Shenbin Road, Minhang District,
Shanghai, China.

Web: www.kollmorgen.cn
Mail: sales.china@kollmorgen.com
Tel.: +86 - 400 668 2802
Fax: +86 - 21 6248 5367