

CAN-Bus®

Fieldbus Interface for S300 / S700



CANopen®

Edition: August 2020

Translation of the original manual



For safe and proper use, follow these instructions.
Keep them for future reference.

Record of Document Revisions :

Revision	Remarks
10 / 2005	First edition (starting from firmware 1.32 - CAN version 0.41)
11 / 2005	Reference and examples combined to one manual
09 / 2006	New design, SDO renamed to Object, Index improved
11 / 2006	Updated for S700 family, Termination resistor (interface) corrected, new objects
08 / 2007	Symbols, Standards
01 / 2008	Corrections, new objects, symbols acc. to ANSI Z535
12 / 2008	Minor corrections
07 / 2009	Correction Status Machine Bit 6, Can logo, product brand
12 / 2009	Minor corrections
06 / 2010	SDOs for Safety cards new, minor corrections
12 / 2010	Object 6094, new company name
05 / 2012	Examples corrected, cover page design
07 / 2014	Warning notes updated, Cover page design
10 / 2014	Safetycards S3 and S4 added, homing methods updated
04 / 2016	Warning signs updated, european directives updated, safe voltage changed to 50V
07 / 2016	ASCII command reference updated, use as directed updated
11 / 2018	Layout of the warning notes updated, user expertise updated, new readers note on cover page
12 / 2019	Layout optimized
08 / 2020	Layout optimized

Trademarks

- Windows is a registered trademark of Microsoft Corporation.
- CANopen is registered trademark CAN in Automation.

Technical changes which improve the performance of the device may be made without prior notice!

This document is the intellectual property of Kollmorgen. All rights reserved. No part of this work may be reproduced in any form (by photocopying, microfilm or any other method) or stored, processed, copied or distributed by electronic means without the written permission of Kollmorgen.

1 Table of Contents

1 Table of Contents	3
2 General Information	9
2.1 About this manual	9
2.2 Target group	9
2.3 Using the PDF Format	9
2.4 Use as directed	10
2.5 Symbols Used	10
2.6 Abbreviations used	10
2.7 Basic features implemented by CANopen	12
2.8 Transmission rate and procedure	12
2.9 Response to BUSOFF communication faults	12
3 Installation / Setup	13
3.1 Important Notes	13
3.2 Setting the station address and the transmission rate	13
3.3 CAN-Bus interface (X6)	14
3.4 CAN-bus cable	14
3.5 Guide to setup	15
3.6 Important configuration parameters for CAN bus operation	15
4 CANopen Communication Profile	16
4.1 General description of CAN	16
4.2 Construction of the Communication Object Identifier (COB-ID)	17
4.3 Definition of the used data types	18
4.3.1 Basic data types	18
4.3.1.1 Unsigned Integer	18
4.3.1.2 Signed Integer	18
4.3.2 Mixed data types	18
4.3.3 Extended data types	19
4.3.3.1 Octet String	19
4.3.3.2 Visible String	19
4.4 Communication Objects	19
4.4.1 Network Management Objects (NMT)	20
4.4.2 Synchronization Object (SYNC)	20
4.4.3 Time-Stamp Object (TIME)	20
4.4.4 Emergency Object (EMCY)	20
4.4.4.1 Application of the Emergency Object	21
4.4.4.2 Composition of the Emergency Object	21
4.4.5 Service Data Objects (SDO)	22
4.4.5.1 Composition of the Service Data Object	22
4.4.5.2 Initiate SDO Download Protocol	23
4.4.5.3 Download SDO Segment Protocol	23
4.4.5.4 Initiate SDO Upload Protocol	23
4.4.5.5 Upload SDO Segment Protocol	23
4.4.5.6 Abort SDO Protocol	24
4.4.6 Process Data Object (PDO)	24
4.4.6.1 Transmission modes	25
4.4.6.2 Trigger modes	25
4.4.7 Nodeguard	26
4.4.8 Heartbeat	27
5 CANopen Drive Profile	28
5.1 Emergency Messages	28

5.2 General Definitions	29
5.2.1 General Objects	29
5.2.1.1 Object 1000h: Device Type (DS301)	29
5.2.1.2 Object 1001h: Error register (DS301)	29
5.2.1.3 Object 1002h: Manufacturer Status Register (DS301)	30
5.2.1.4 Object 1003h: Predefined Error Field (DS301)	31
5.2.1.5 Object 1005h: COB-ID of the SYNC Message (DS301)	32
5.2.1.6 Object 1006h: Communication Cycle Period (DS301)	32
5.2.1.7 Object 1008h: Manufacturer Device Name (DS301)	32
5.2.1.8 Object 1009h: Manufacturer Hardware Version	33
5.2.1.9 Object 100Ah: Manufacturer Software Version (DS301)	33
5.2.1.10 Object 100Ch: Guard Time (DS301)	33
5.2.1.11 Object 100Dh: Lifetime Factor (DS301)	33
5.2.1.12 Object 1010h: Store Parameters (DS301)	34
5.2.1.13 Object 1011h: Restore Default Parameters DS301	35
5.2.1.14 Object 1014h: COB-ID for Emergency Message (DS301)	35
5.2.1.15 Object 1016h: Consumer Heartbeat Time	36
5.2.1.16 Object 1017h: Producer Heartbeat Time	36
5.2.1.17 Object 1018h: Identity Object (DS301)	37
5.2.1.18 Object 1026h: OS Prompt	38
5.2.1.19 Object 2000h: Manufacturer Warnings	39
5.2.1.20 Object 2014-2017h: 1st-4th Mask 1 to 4 for Transmit-PDO	40
5.2.1.21 Object 2030h: DP-RAM Variables (write only)	40
5.2.1.22 Object 2040h: Gearing factor for electronic gearing	41
5.2.1.23 Object 2041h: Electric gearing actual value	42
5.2.1.24 Object 2051h: Configuration of Position Registers	43
5.2.1.25 Object 2052h: Position Registers, absolute	44
5.2.1.26 Object 2053h: Positions Registers, relative	44
5.2.1.27 Object 2061h: Current limitation for velocity mode	45
5.2.1.28 Object 2080h: Motion Task Select	45
5.2.1.29 Object 2081h: Active Motion Task Display	45
5.2.1.30 Object 2082h: Copy motion tasks	46
5.2.1.31 Object 2083h: Delete Motion tasks	46
5.2.1.32 Object 2090h: DP-RAM Variables (read only)	46
5.2.1.33 Object 20A0h: Latch position 1, positive edge	47
5.2.1.34 Object 20A1h: Latch position 1, negative edge	47
5.2.1.35 Object 20A2h: Latch position 2, positive edge	47
5.2.1.36 Object 20A3h: Latch position 2, negative edge	48
5.2.1.37 Object 20A4h: Latch Control Register	48
5.2.1.38 Object 20B0h: Trigger Variable Digital Input 20	48
5.2.1.39 Object 20B1h: Control Word Digital Inputs 5...20	49
5.2.1.40 Object 20B2h: Analog Inputs	49
5.2.1.41 Object 2100h: Write Dummy	50
5.2.1.42 Object 2101h: Read Dummy	50
5.2.1.43 Object 60FDh: Digital inputs (DS402)	50
5.2.1.44 Object 6502h: Supported drive modes (DS402)	51
5.3 PDO Configuration	51
5.3.1 Receive PDOs (RXPDO)	52
5.3.1.1 Objects 1400-1403h: 1st - 4th RxPDO communication parameter (DS301)	52
5.3.1.2 Objects 1600-1603h: 1st - 4th RxPDO mapping parameter (DS301)	53
5.3.1.3 Default RXPDO definition	53
5.3.2 Transmit PDOs (TXPDO)	54
5.3.2.1 Objects 1800-1803h: 1st - 4th TxPDO communication parameter (DS301)	54
5.3.2.2 Objects 1A00-1A03h: 1st - 4th TxPDO mapping parameter (DS301)	56

5.3.2.3 Default TXPDO definition	56
5.4 Device control (dc)	57
5.4.1 Status Machine (DS402)	57
5.4.1.1 States of the Status Machine	57
5.4.1.2 Transitions of the status machine	58
5.4.2 Object Description	59
5.4.2.1 Object 6040h: Control word (DS402)	59
5.4.2.2 Object 6041h: Status word (DS402)	61
5.4.2.3 Object 6060h: Modes of Operation (DS402)	62
5.4.2.4 Object 6061h: Modes of Operation Display (DS402)	63
5.5 Factor Groups (fg) (DS402)	63
5.5.1 General Information	63
5.5.1.1 Factors	63
5.5.1.2 Relationship between Physical and Internal Units	63
5.5.2 Objects for position calculation	64
5.5.2.1 Object 6089h: position notation index (DS402)	64
5.5.2.2 Object 608Ah: Position Dimension Index (DS402)	64
5.5.2.3 Object 608Fh: Position encoder resolution (DS402)	65
5.5.2.4 Object 6091h: Gear Ratio (DS402)	66
5.5.2.5 Object 6092h: Feed constant (DS402)	67
5.5.2.6 Object 6093h: Position factor (DS402)	68
5.5.2.7 Object 6094h: Velocity encoder factor (DS402)	69
5.5.3 Objects for velocity calculations	70
5.5.3.1 Object 608Bh: velocity notation index (DS402)	70
5.5.3.2 Object 608Ch: velocity dimension index (DS402)	70
5.5.4 Objects for acceleration calculations	71
5.5.4.1 Object 608Dh: acceleration notation index (DS402)	71
5.5.4.2 Object 608Eh: acceleration dimension index (DS402)	71
5.5.4.3 Object 6097h: Acceleration factor (DS402)	72
5.6 Profile Velocity Mode (pv) (DS402)	73
5.6.1 General Information	73
5.6.2 Objects that are defined in this section	73
5.6.3 Objects that are defined in other sections	73
5.6.4 Object Description	73
5.6.4.1 Object 606Ch: Velocity actual value (DS402)	73
5.6.4.2 Object 60FFh: Target velocity (DS402)	73
5.7 Profile Torque Mode (tq) (DS402)	74
5.7.1 General Information	74
5.7.2 Objects that are defined in this section	74
5.7.3 Object Description	74
5.7.3.1 Object 6071h: Target torque (DS402)	74
5.7.3.2 Object 6073h: Max current (DS402)	74
5.7.3.3 Object 6077h: Torque actual value (DS402)	74
5.8 Position Control Function (pc) (DS402)	75
5.8.1 General Information	75
5.8.2 Objects that are defined in this section	75
5.8.3 Objects that are defined in other sections	75
5.8.4 Object Description	75
5.8.4.1 Object 6063h: position actual value* (DS402)	75
5.8.4.2 Object 6064h: position actual value (DS402)	76
5.8.4.3 Object 6065h: Following error window	76
5.8.4.4 Object 6067h: Position window (DS402)	76
5.8.4.5 Object 6068h: Position window time (DS402)	77
5.8.4.6 Object 60F4h: Following error actual value (DS402)	77

5.9 Interpolated Position Mode (ip) (DS402)	78
5.9.1 General information	78
5.9.2 Objects that are defined in this section	78
5.9.3 Object description	78
5.9.3.1 Object 60C0h: Interpolation sub mode select	78
5.9.3.2 Object 60C1h: Interpolation data record	79
5.9.3.3 Object 60C2h: Interpolation time period	80
5.9.3.4 Object 60C3h: Interpolation sync definition	81
5.9.3.5 Object 60C4h: Interpolation data configuration	81
5.10 Homing Mode (hm) (DS402)	83
5.10.1 General information	83
5.10.2 Objects that are defined in this section	83
5.10.3 Objects that are defined in other sections	83
5.10.4 Object description	83
5.10.4.1 Object 607Ch: Homing offset (DS402)	83
5.10.4.2 Object 6098h: Homing method (DS402)	84
5.10.4.3 Object 6099h: Homing speeds (DS402)	85
5.10.4.4 Object 609Ah: Homing acceleration (DS402)	85
5.10.5 Homing Mode Sequence	86
5.11 Profile Position Mode (pp)	86
5.11.1 General Information	86
5.11.2 Objects that are defined in this section	86
5.11.3 Objects that are defined in other sections	86
5.11.4 Object description	87
5.11.4.1 Object 607Ah: Target position (DS402)	87
5.11.4.2 Object 607Dh: Software position limit (DS402)	87
5.11.4.3 Object 607Fh: Max profile velocity (DS402)	88
5.11.4.4 Object 6080h: Max motor speed (DS402)	88
5.11.4.5 Object 6081h: Profile velocity (DS402)	88
5.11.4.6 Object 6083h: Profile acceleration (DS402)	89
5.11.4.7 Object 6084h: Profile deceleration (DS402)	89
5.11.4.8 Object 6085h: Quick stop deceleration	89
5.11.4.9 Object 6086h: Motion Profile T type (DS402)	90
5.11.4.10 Object 60C5h: Max acceleration	90
5.11.5 Functional Description	91
6 Appendix	93
6.1 The Object Channel	93
6.1.1 Objects >3500h Manufacturer specific object channel	93
6.1.2 ASCII command reference	95
6.1.3 Object Dictionary	104
6.2 CANopen SDOs for Safety Expansion Card S1/S2/S1-2/S2-2	111
6.2.1 Object 2400h: Safety card serial number	111
6.2.2 Object 2401h: Safety card status	111
6.2.3 Object 2402h: Safety card I/O status	112
6.2.4 Object 2403h: Safety card error register	113
6.2.5 Object 2404h: Safety card error stack error number	114
6.2.6 Object 2405h: Safety card error stack error time	114
6.2.7 Object 2406h: Safety card error stack error index	115
6.2.8 Object 2407h: Safety card error stack error info	115
6.2.9 Object 2408h: Safety card error stack error parameter 1	116
6.2.10 Object 2409h: Safety card error stack error parameter 2	116
6.2.11 Object 240Ah: Safety card error stack error parameter 3	117
6.2.12 Object 240Bh: Safety card error stack error parameter 4	117
6.2.13 Object 240Ch: Actual speed	118

6.3 Examples	118
6.3.1 Basic testing of the connection to the S300/S700 controls	118
6.3.2 Example: Operating the Status Machine	119
6.3.3 Example: Jog Mode via SDO	120
6.3.4 Example: Torque Mode via SDO	120
6.3.5 Example: Jog Mode via PDO	121
6.3.6 Example: Torque Mode via PDO	122
6.3.7 Example: Homing via SDO	123
6.3.8 Example: Start Motion Task from the internal memory of S300/S700 via SDO	124
6.3.9 Example: Using the Profile Position Mode	125
6.3.10 Example: ASCII Communication via SDO	128
6.3.11 Test for SYNC telegrams	129
6.3.12 Application: Electric Gearing	130
6.3.13 Application: External Trajectory with Interpolated Position Mode	131
7 Index	137

---/---

2 General Information

2.1 About this manual

This manual describes the setup, range of functions and software protocol of the Kollmorgen S300/S700 servo amplifiers with the CANopen communication profile. It forms part of the complete documentation for the S300/S700 families of servo amplifiers.

The installation and setup of the servo amplifier, as well as all standard functions, are described in the corresponding instructions manual.

Other parts of the complete documentation for the digital servo amplifier series:

Title	Publisher
Instructions manuals S300/S700	Kollmorgen
Online-Help with ASCII Object Reference	Kollmorgen

Additional documentation:

Title	Publisher
CAN Application (CAL) for Industrial Applications	CiA e.V.
Draft Standards 301 (from Version 4.0), 402	CiA e.V.
CAN Specification Version 2.0	CiA e.V.

ISO 11898 ... Controller Area Network (CAN) for high-speed communication

2.2 Target group

This manual addresses personnel with the following qualifications:

Transport:	Only by personnel with knowledge of handling electrostatically sensitive components.
Unpacking:	Only by electrically qualified personnel.
Installation:	Only by electrically qualified personnel.
Setup :	Only by qualified personnel with extensive knowledge of electrical engineering and drive technology.
Programming:	Software developers, CAN bus project-planners

The qualified personnel must know and observe IEC 60364/ 60664, and regional accident prevention regulations.

Qualified Personnel only!

During operation there are deadly hazards, with the possibility of death, severe injury or material damage.

- The user must ensure that the safety instructions in this manual are followed.
- The user must ensure that all personnel responsible for working with the servo amplifier have read and understood the instructions manual.

Training courses are available on request.

2.3 Using the PDF Format

This document includes several features for ease of navigation

Cross References	Table of contents and index include active cross references.
Table of contents and index	Lines are active cross references. Click on the line and the appropriate page is accessed.
Page/chapter numbers in the text	Page/chapter numbers with cross references are active links.











2.4 Use as directed

Please observe the chapters "Use as directed" and "Prohibited use" in the instructions manual for the servo amplifier.

The CANopen interface serves only for the connection of the servo amplifier to a master via the CAN-bus. The servo amplifiers are components that are built into electrical apparatus or machinery, and can only be setup and operated as integral components of such apparatus or machinery.

We only guarantee the conformity of the servo amplifier with the directives listed in the EU Declaration of Conformity, if the components that we specify are used, and the installation regulations are followed.

2.5 Symbols Used

Symbol	Indication
	Indicates a hazardous situation which, if not avoided, will result in death or serious injury.
	Indicates a hazardous situation which, if not avoided, could result in death or serious injury.
	Indicates a hazardous situation which, if not avoided, could result in minor or moderate injury.
	Indicates situations which, if not avoided, could result in property damage.
	This symbol indicates important notes.
	Warning of a danger (general). The type of danger is specified by the text next to the symbol.
	Warning of danger from electricity and its effects.
	Warning of danger from suspended loads.
	Warning of danger from automatic start.
	State-of-the-art firewall

2.6 Abbreviations used

Abbreviation	Meaning
BTB/RTO	Ready to operate (standby)
COB	Communication Object
COB-ID	Communication Object Identifier
EEPROM	Electrically erasable/programmable memory
EMC	Electromagnetic compatibility
ISO	International Standardization Organization
km	1000 m
LED	Light-emitting diode
MB	Megabyte
NSTOP	Limit switch for CCW (left) rotation
PC	Personal Computer

Abbreviation	Meaning
PDO	Process Data Object
PSTOP	Limit switch for CW (right) rotation
RAM	Volatile memory
ROD	Incremental position encoder
RXPDO	Receive PDO
SDO	Service Data Object
TXPDO	Transmit PDO

2.7 Basic features implemented by CANopen

When working with the position controller that is integrated in S300/S700 digital servo amplifiers, the following functions are available:

Setup and general functions:

- homing, set reference point
- provision of a digital setpoint for speed and torque control
- support of the following modes of the CANopen Profile DS402:
 - profile position mode
 - homing mode
 - profile torque mode
 - interpolated position mode
 - profile velocity mode

Positioning functions:

- execution of a motion task from the motion block memory of the servo amplifier
- execution of a direct motion task
- absolute trajectory, ip-Mode

Data transfer functions:

- transmit a motion task to the motion block memory of the servo amplifier A motion task consists of the following elements:
 - position setpoint (absolute task) or path setpoint (relative task)
 - speed setpoint
 - acceleration time, braking time
 - type of motion task (absolute/relative)
 - number of a following task (with or without pause)
- read a motion task from the motion block memory of the servo amplifier
- read actual values
- read the error register
- read the status register
- read/write control parameters

2.8 Transmission rate and procedure

- bus connection and bus medium: CAN-standard ISO 11898 (CAN high-speed)
- transmission rate: max. 1Mbit/s, possible settings for the servo amplifier: 10, 20, 50, 100, 125, 250, 333, 500 (default), 666, 800, 1000 kbit/s

2.9 Response to BUSOFF communication faults

The communication fault BUSOFF is directly monitored and signaled by Level 2 (CAN controller). This message may have various causes.

A few examples:

- telegrams are transmitted, although there is no other CAN node connected
- CAN nodes have different transmission rates
- the bus cable is faulty
- faulty cable termination causes reflections on the cable.

A BUSOFF is only signaled by the S300/S700 if another CAN node is connected and at least one object was successfully transmitted to start off with. The BUSOFF condition is signaled by the error message F23. If the output stage is enabled for the execution of a motion task at the moment when this fault occurs, then the drive is braked to a stop, using the emergency stop ramp, and the output stage is disabled.

3 Installation / Setup

3.1 Important Notes



⚠ DANGER High Voltages up to 900V!

Risk of electric shock. Residual charges in the capacitors can still have dangerous levels several minutes after switching off the supply voltage. Power and control connections can still be live, even though the motor is not rotating.

- Install and wire up the equipment only while it is not electrically connected.
- Make sure that the control cabinet is safely isolated (lock-out, warning signs etc.). The individual supply voltages will not be switched on until setup is carried out.
- Measure the voltage in the intermediate (DC-link) circuit and wait until it has fallen below 50V.



⚠ WARNING Automatic Start!

Risk of death or serious injury for humans working in the machine. Drives with servo amplifiers in fieldbus systems are remote-controlled machines. They can start to move at any time without previous warning.

- Implement appropriate protective measures to ensure that any unintended start-up of the machines cannot result in dangerous situations for personnel or machinery.
- The user is responsible for ensuring that, in the event of a failure of the servo amplifier, the drive is set to a state that is functional safe, for instance with the aid of a safe mechanical brake.
- Software limit-switches are not a substitute for the hardware limit-switches in the machine.

NOTICE

Assemble the servo amplifier as described in the instructions manuals for S300/S700. Observe all safety instructions in the instructions manual that belong to the servo amplifier. Follow all the notes on mounting position, ambient conditions, wiring, and fusing.

3.2 Setting the station address and the transmission rate

During setup it makes sense to use the keypad on the servo amplifier's front panel to preset the station address and the Baud rate for communication (see setup instructions in the instructions manual).

NOTE

After changing the station address and/or baud rate you must turn the 24V auxiliary supply for the servo amplifier off and on again for reset.

The **station address** (range from 1 to 127) can be set in three different ways:

- by using the keypad on the servo amplifier's front panel (see setup instructions in the instructions manual)
- in the setup software DriveGUI.exe, on the screen page "CAN / Fieldbus"
- by using the ASCII command sequence (nn = address):
ADDR nn → SAVE → COLDSTART

The **transmission rate** can be set in three different ways:

- by using the keypad on the servo amplifier's front panel (see setup instructions in the instructions manual)
- In the setup software DriveGUI.exe, on the screen page "CAN / Fieldbus"
- Using the ASCII command sequence (bb = baud rate in kbit/s):
CBAUD bb → SAVE → COLDSTART.

Coding of the transmission rate in the LED display:

Coding	Baud Rate in kbit/s	Coding	Baud Rate in kbit/s
1	10	33	333
2	20	50	500
5	50	66	666
10	100	80	800
12	125	100	1000
25	250		

3.3 CAN-Bus interface (X6)

The interface for connection to the CAN-bus (default : 500 kBaud). The interface is at the same electrical potential as the RS232 interface. The analog setpoint inputs can still be used.

We can supply special clamp-sleeve connectors, that can easily be made up for bus operation.

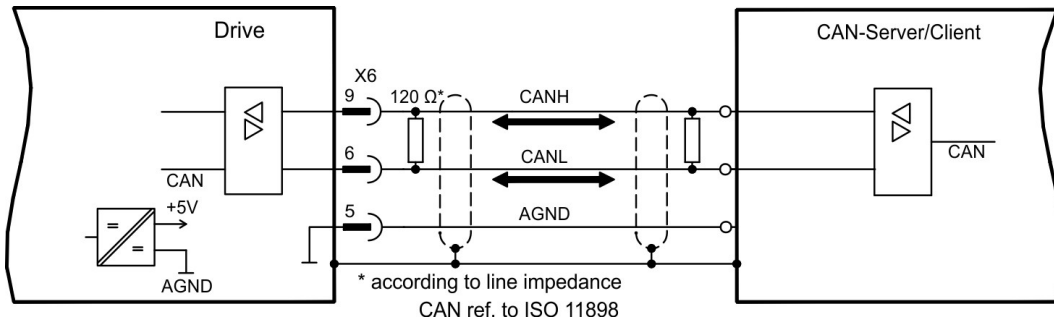

3.4 CAN-bus cable

To meet ISO 11898, a bus cable with a characteristic impedance of 120 Ω should be used. The maximum usable cable length for reliable communication decreases with increasing transmission rate. As a guide, you can use the following values which we have measured, but they are not to be taken as assured limits:

Cable data:

- Characteristic impedance: 100-120 Ω
- Cable capacitance: max. 60 nF/km
- Lead loop resistance: 159.8 Ω/km

Cable length, depending on the transmission rate

Transmission rate (kBaud)	max. cable length (m)
1000	10
500	70
250	115

Lower cable capacitance (max. 30 nF/km) and lower lead resistance (loop resistance, 115 Ω/km) make it possible to achieve greater distances. (Characteristic impedance 150 ± 5Ω → terminating resistor 150 ± 5Ω).

For EMC reasons, the SubD connector housing must fulfill the following requirements:

- metal or metalized housing
- provision for cable shielding connection on the housing, large-area connection

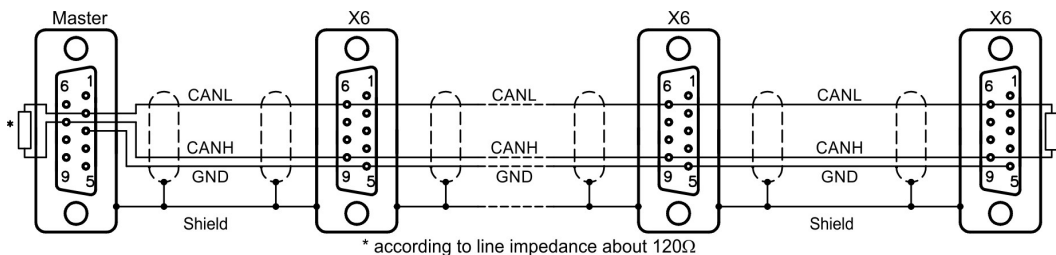

3.5 Guide to setup

NOTICE

Only professional personnel with extensive knowledge of control and drive technology are allowed to setup the servo amplifier.



WARNING Automatic Restart!

Risk of death or serious injury for humans working in the machine. The drive performing unplanned movements during commissioning cannot be ruled out. Make sure that, even if the drive starts to move unintentionally, no danger can result for personnel or machinery. The measures you must take in this regard for your task are based on the risk assessment of the application.

Check assembly / installation	Check that all the safety instructions in the instructions manual for the servo amplifier and this manual have been observed and implemented. Check the setting for the station address and baud rate.
Connect PC, start setup software	Use the setup software to set the parameters for the servo amplifier.
Setup basic functions	Start up the basic functions of the servo amplifier and optimize the current, speed and position controllers. This section of the setup is described in the in the online help of the setup software.
Save parameters	When the parameters have been optimized, save them in the servo amplifier.
Start up communication	The altered parameters will only become effective after a software reset (warm boot). To do this, click the Reset button in the tool bar of the setup software. It is required, that the software protocol (see from (→ # 28)) is implemented in the master. Adjust the transmission rate of the S300/S700 to match the master.
Test communication	Check for the bootup-message, when you switch on the drive. Do an SDO read access on index 0x1000 subindex 0 (DeviceType). See examples from (→ # 118).
Setup position controller	Setup the position controller, as described in the setup software online help.

3.6 Important configuration parameters for CAN bus operation

The following parameters are important for CAN operation:

1. **CBAUD** : transmission rate for the CAN bus
2. **ADDR** : The ADDR command defines the fieldbus address of the amplifier. After making a change to the address, all the parameters must be saved in the EEPROM, and the amplifier must be switched off and on again.
3. **AENA**: This can be used to define the state of the software enable when the amplifier is switched on. The software enable provides an external control with the facility of enabling or disabling the output stage through software control. On devices that function with an analog setpoint (OPMODE=1,3), the software enable is set automatically when the amplifier is switched on, so that these instruments are immediately ready to operate (provided that the hardware enable is present). For all other instruments, the software enable is set to the value of AENA at switch-on. The variable AENA also has a function for the reset of the amplifier after a fault (via digital input 1 or through the ASCII command CLRFAULT). For errors that can be reset through software, after the error/fault has been cleared, the software enable is set to the state of AENA. In this way, the response of the amplifier for a software reset is analogous to the switch-on behavior.

4 CANopen Communication Profile

This chapter describes the basic services and communication objects of the CANopen communication profile DS 301, which are used in the S300/S700.

NOTE

It is assumed that the basic operating functions of the communication profile are known, and available as reference documentation.

4.1 General description of CAN

The transmission method that is used here is defined in ISO 11898 (Controller Area Network CAN for high-speed communication).

The Layer-1/2 protocol (Physical Layer/Data Link Layer) that is implemented in all CAN modules provides, amongst other things, the requirements for data.

Data transport or data request is made by means of a data telegram (Data Frame) with up to 8 bytes of user data, or by a data request telegram (Remote Frame).

Communication objects (COBs) are labeled by an 11-bit Identifier (ID) that also determines the priority of objects.

A Layer-7 protocol (Application Layer) was developed, to decouple the application from the communication. The service elements that are provided by the Application Layer make it possible to implement an application that is spread across the network. These service elements are described in the CAN Application Layer (CAL) for Industrial Applications.

The communication profile CANopen and the drive profile are mounted on the CAL.

The basic structure of a communication object is shown in the following diagram:



SOM	Start of message
COB-ID	Communication Object Identifier (11-bit)
RTR	Remote Transmission Request
CTRL	Control Field (e.g. Data Length Code)
Data Segment	0 ... 8 byte (Data-COB) 0 byte (Remote-COB)
CRC	Cyclic Redundancy Check
ACK	Acknowledge slot
EOM	End of message

4.2 Construction of the Communication Object Identifier (COB-ID)

The following diagram shows the layout of the COB Identifier (COB-ID). The Function Code defines the interpretation and priority of the particular object.

10	9	8	7	6	5	4	3	2	1	0
Function-Code				Module-ID						

Bit 0 .. 6:

Module ID (servo amplifier's CAN-bus address, range 1 ... 127; is set up in the setup software or the servo amplifier (→ # 14).

Bit 7... 10:

Function Code (number of the communication object that is defined in the server)

NOTE

If an invalid station number (=0 or >127) is set, then the module will be set internally to 1.

The following tables show the default values for the COB Identifier after switching on the servo amplifier. The objects, which are provided with an index (Communication Parameters at Index), can have a new ID assigned after the initialization phase. The indices in brackets are optional.

Predefined broadcast objects (send to all nodes):

Object	Function code (binary)	Resulting COB-IDs		Communication parameters at index
		Dec.	Hex.	
NMT	0000	0	0h	—
SYNC	0001	128	80h	(1005h)
TIME	0010	256	100h	not supported

Predefined Peer-to-Peer objects (node sends to node):

Object	Function code (binary)	Resulting COB-IDs		Communication parameters at index	Priority	
		Dec.	Hex.			
EMERGENCY	0001	129..255	81h..FFh	—	high	
TPDO 1	0011	385..511	181h..1FFh	1800h	↓	
RPDO 1	0100	513..639	201h..27Fh	1400h		
TPDO 2	0101	641..767	281h..2FFh	1801h		
RPDO 2	0110	769..895	301h..37Fh	1401h		
TPDO 3	0110	897..1023	381h..3FFh	1802h		
RPDO 3	1000	1025..1151	401h..47Fh	1402h		
TPDO 4	1001	1153..1279	481h..4FFh	1803h		
RPDO 4	1010	1281..1407	501h..57Fh	1403h		
SDO (tx*)	1011	1409..1535	581h..5FFh			
SDO (rx*)	1100	1537..1663	601h..67Fh			
Nodeguard	1110	1793..1919	701h..77Fh	(100Eh)		low

*tx = direction of transmission: S300/S700 → Master

rx = direction of transmission: Master → S300/S700

4.3 Definition of the used data types

This chapter defines the data types that are used. Each data type can be described by bit-sequences. These bit-sequences are grouped into "Octets" (bytes). The so-called "Little – Endian" format (also known as "Intel format") is used for numerical data types (see also: DS301 Application Layer "General Description of Data Types and Encoding Rules").

4.3.1 Basic data types

4.3.1.1 Unsigned Integer

Data in the basic data type UNSIGNEDn define exclusively positive integers.

The value range is from 0 ... 2^n-1 . The bit sequence $b = b_0 \dots b_{n-1}$ defines the value $UNSIGNEDn(b) = b_{n-1} 2^{n-1} + \dots + b_1 2^1 + b_0 2^0$

Example: the value 266 = 10Ah is transmitted in the data type UNSIGNED16, in the form of two octets (1st octet = 0Ah, 2nd octet = 01h).

Transmission syntax for the data type UNSIGNEDn

Octet number	1.	2.	3.	4.	5.	6.	7.	8.
UNSIGNED8	b _{7..b₀}							
UNSIGNED16	b _{7..b₀}	b _{15..b₈}						
UNSIGNED24	b _{7..b₀}	b _{15..b₈}	b _{23..b₁₆}					
UNSIGNED32	b _{7..b₀}	b _{15..b₈}	b _{23..b₁₆}	b _{31..b₂₄}				
UNSIGNED40	b _{7..b₀}	b _{15..b₈}	b _{23..b₁₆}	b _{31..b₂₄}	b _{39..b₃₂}			
UNSIGNED48	b _{7..b₀}	b _{15..b₈}	b _{23..b₁₆}	b _{31..b₂₄}	b _{39..b₃₂}	b _{47..b₄₀}		
UNSIGNED56	b _{7..b₀}	b _{15..b₈}	b _{23..b₁₆}	b _{31..b₂₄}	b _{39..b₃₂}	b _{47..b₄₀}	b _{55..b₄₈}	
UNSIGNED64	b _{7..b₀}	b _{15..b₈}	b _{23..b₁₆}	b _{31..b₂₄}	b _{39..b₃₂}	b _{47..b₄₀}	b _{55..b₄₈}	b _{63..b₅₆}

4.3.1.2 Signed Integer

Data in the basic data type INTEGERn define both positive and negative integers.

The value range is from $-2^{n-1}-1 \dots 2^{n-1}-1$. The bit sequence $b = b_0 \dots b_{n-1}$ defines the value $INTEGERn(b) = b_{n-2} 2^{n-2} + \dots + b_1 2^1 + b_0 2^0$ with $b_{n-1} = 0$

Negative numbers are represented as 2's complement, which means:

$INTEGERn(b) = -INTEGERn(b) - 1$ with $b_{n-1} = 1$

Example: the value -266 = FEF6h is transmitted in the data type INTEGER16, in the form of two octets (1st octet = F6h, 2nd octet = FEh).

Transmission syntax for the data type INTEGERn

Octet number	1.	2.	3.	4.	5.	6.	7.	8.
INTEGER8	b _{7..b₀}							
INTEGER16	b _{7..b₀}	b _{15..b₈}						
INTEGER24	b _{7..b₀}	b _{15..b₈}	b _{23..b₁₆}					
INTEGER32	b _{7..b₀}	b _{15..b₈}	b _{23..b₁₆}	b _{31..b₂₄}				
INTEGER40	b _{7..b₀}	b _{15..b₈}	b _{23..b₁₆}	b _{31..b₂₄}	b _{39..b₃₂}			
INTEGER48	b _{7..b₀}	b _{15..b₈}	b _{23..b₁₆}	b _{31..b₂₄}	b _{39..b₃₂}	b _{47..b₄₀}		
INTEGER56	b _{7..b₀}	b _{15..b₈}	b _{23..b₁₆}	b _{31..b₂₄}	b _{39..b₃₂}	b _{47..b₄₀}	b _{55..b₄₈}	
INTEGER64	b _{7..b₀}	b _{15..b₈}	b _{23..b₁₆}	b _{31..b₂₄}	b _{39..b₃₂}	b _{47..b₄₀}	b _{55..b₄₈}	b _{63..b₅₆}

4.3.2 Mixed data types

Mixed data types combine basic data types (INTEGERn, UNSIGNEDn, REAL). Two types of mixed data are distinguished:

- STRUCT
This data type is composed of elements with different data types.
- ARRAY
This data type is composed of elements of the same data type.

4.3.3 Extended data types

Extended data types are derived from basic data types and mixed data types. The types of extended data that are supported are defined below.

4.3.3.1 Octet String

The data type OCTET_STRING is defined with the data type ARRAY. Length is the length of the octet string.

ARRAY[length] OF UNSIGNED8 = OCTET_STRINGlength

4.3.3.2 Visible String

The data type VISIBLE_STRING can be defined with the data type UNSIGNED8 or the data type ARRAY. Permissible values are 00h and the range from 20h to 7Eh.

The data are interpreted as 7 bit ASCII code (as per ISO 646-1973(E)). Length is the length of the visible string.

UNSIGNED8 = VISIBLE_CHAR

ARRAY[length] OF VISIBLE_CHAR = VISIBLE_STRINGlength

4.4 Communication Objects

Communication objects are described with the help of service elements and protocols. Two basic types of service elements are distinguished:

- Unconfirmed services PDO
- Confirmed services SDO

All services require faultless operation of the Data Link and Physical Layer.

S300/S700 supports communication objects that are described in detail in the following sections:

- Network Management Objects (NMT)
- Synchronization Object (SYNC)
- Emergency Object (EMCY)
- Process Data Object (PDO)
- Service Data Object (SDO)
- Nodeguard

4.4.1 Network Management Objects (NMT)

The NMT telegram looks like this:

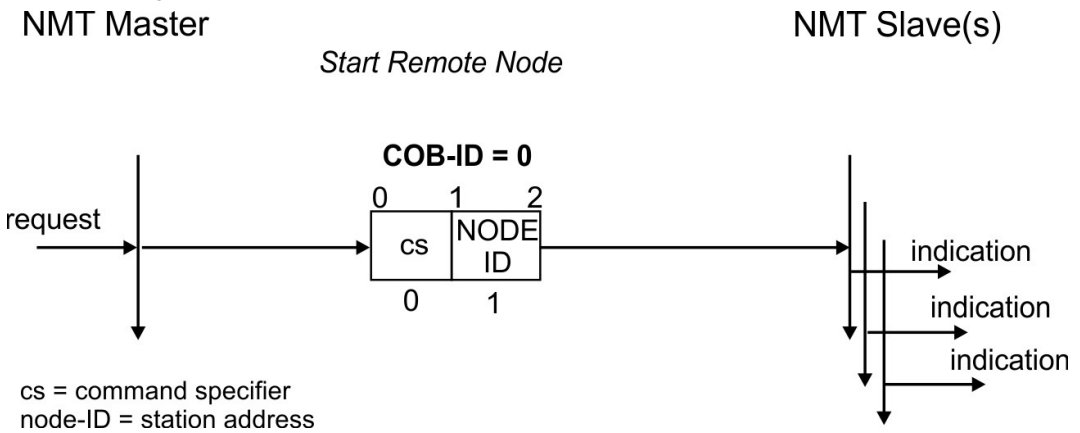

The drive supports the following network management functions:

- cs = 129, reset node:** causes a cold-start of the drive. This deletes all parameters saved in the RAM and loads the values stored in the EEPROM.
- cs = 130, reset communication node:** causes a stop of PDO-communication, gives a new bootup-message
- cs = 1, start remote node:** starts the CAN node. I.e. the PDOs of the drive are enabled for operation. From this moment, transmit-PDOs will be transmitted under eventcontrol, and cyclical process data operation can commence.
- cs = 2, stop remote node:** stops the CAN node, I.e. the drive no longer responds to any received PDOs or transmits any PDOs.

4.4.2 Synchronization Object (SYNC)

The SYNC object usually is used as a periodic Broadcast Object and provides the basic clock for the bus. SYNC has a high priority, to ensure constant time intervals. The usage of this protocol is explained in the appendix from page (→ # 118). You can use the SYNC object to start motion task of several axes simultaneously for example.

4.4.3 Time-Stamp Object (TIME)

This communication object is not supported by S300/S700.

4.4.4 Emergency Object (EMCY)

EMCY is event-triggered and generated by an internal fault/error situation. This object is transmitted afresh for every error. Since the error codes are device-dependent, they are described in the Chapter CANopen Drive Profile (→ # 28). The last 8 Emergency error codes can be read via object 1003.

4.4.4.1 Application of the Emergency Object

The reaction in the event of an error or fault depends on the error class and is therefore variable. For this reason, the reaction is described with the aid of an error status machine. The error conditions errorfree and error occurred are distinguished. The following transitions are defined:

0. After initialization, the error-free status is taken up if no errors are detected. No error signal is generated in this condition.
1. The S300/S700 detects an internal error and indicates this in the first three bytes of the emergency telegram (error code in Bytes 0,1 and error register in Byte 2). Since the S300/S700 can distinguish between different types of error, Byte 3 of the manufacturer specific error field is used to indicate the error category.
2. One error has been reset, but not all. The EMCY telegram contains error code 0000h and the error register indicates the remaining errors that are present. The manufacture-specific area is set to zero.
3. A new error has occurred. The S300/S700 remains in the error status and transmits an EMCY Object with the corresponding error code. The new error code is entered in Bytes 0 and 1.
4. All errors have been reset. The EMCY telegram contains the error code 0000h, the error register does not indicate any other errors. The manufacture-specific area is set to zero.

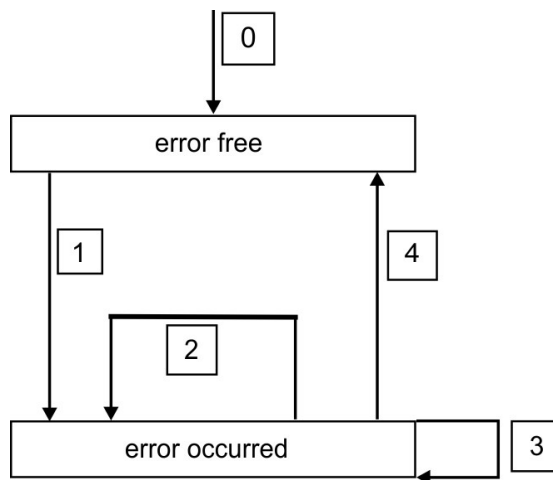

4.4.4.2 Composition of the Emergency Object

The Emergency Object is composed of 8 bytes, divided as follows:

Byte	0	1	2	3	4	5	6	7
Content	Emergency error code (→ # 28)		Error register (object 1001h)	Category	Reserved			

If an Emergency Object is generated, the error condition is then signaled to the status machine (error free / error occurred) by the generation of a second Emergency Object. Only the first four bytes are relevant in this case (Emergency Error code, Error register, Category). Byte 0/1 contains the Error Reset code (0000h) and Byte 2 indicates if a possible further error is present. If the error register contains 00h, the error status is error-free.

Byte 3 contains the category. The interpretations of the error numbers (error code) and the error categories are described in the section Emergency Messages (→ # 28). The error register is defined through object 1001h Error register.

4.4.5 Service Data Objects (SDO)

SDOs are used to implement access to the Object Dictionary. The SDOs are required for parameterization and for status polling. Access to an individual object is made with a multiplexer via the Index and Subindex of the Object Dictionary. The following communication protocols are supported by S300/S700:

- Initiate SDO Download Protocol
- Download SDO Segment Protocol
- Initiate SDO Upload Protocol
- Upload SDO Segment Protocol
- Abort SDO Transfer Protocol

The definitions of the individual communication services and protocols can be found in DS301. Examples of the usage of SDOs can be found in the appendix from page (→ # 118).

NOTE

Since an SDO is a confirmed service, the system must always wait for the SDO response telegram before it is allowed to transmit a new telegram.

4.4.5.1 Composition of the Service Data Object

An SDO consists of the following components:

Byte	1	2	3	4	5	6	7	8
Content	rw	Index		Subindex				Data

1. The control byte (Byte 1):

The control byte determines whether the SDO should write or read the content of the entry in the Object Dictionary. A description of the complete Object Dictionary for S300/S700 (→ # 104).

Data exchange with the S300/S700 is governed by the CMS multiplexed domain protocols standard, as described in the CAN standard DS 202. To read data, the control byte must be written in the manner shown below:

Bit	7	6	5	4	3	2	1	0
Content	ccs*=2			X	X	X	X	X

*ccs → client command specifier (ccs = 2 → initiate upload request)

X → free data

So a value of 0100 0000 (binary) or 40h has to be transmitted in the control byte. The servo amplifier sends back a corresponding response byte:

Bit	7	6	5	4	3	2	1	0
Content	scs*=2			X		n	e	s

*scs → server command specifier (scs = 2 → initiate upload response)

n → only valid for e = s = 1

In that case, n contains the number of bytes that do not contain data

X → free data

If reading is successful, the response byte always has set the bits 0 and 1 (e = s = 1). Encoded byte length in the SDO response:

0x43 - 4 bytes

0x47 - 3 bytes

0x4B - 2 bytes

0x4F - 1 byte.

If an error occurs, scs is set to 4, the response byte is 0x80 and the error information is in the four byte data field. The decoding of the error (→ # 24).

To write data, the control byte must be written in the manner shown below:

Client Byte	Initiate Domain Download								Server								
	7	6	5	4	3	2	1	0		2	3	4	5	6	7	8	
request	cos = 1			X	n	e	s		m				d				indication
	==> ==> ==> ==> ==> ==> ==> ==> ==> ==> ==> ==> ==> ==> ==>																

n, e and s are defined like in the reading case, m: index + sub-index, d: data field with 4 bytes The data length of an object can be taken from the object dictionary in the appendix.

The control byte should be:

0x23 for a 4-byte access

0x27 for a 3-byte access

0x2B for a 2-byte access

0x2F for a 1-byte access

Client Byte	Initiate Domain Download								Server								
	7	6	5	4	3	2	1	0		2	3	4	5	6	7	8	
confirm	scs = 3				X				m				reserved				response
	<== <== <== <== <== <== <== <== <== <== <== <== <== <== <==																

2. Index (Bytes 2 and 3):

The Index is the main entry in the Object Dictionary, and divides the parameters into groups. (Example: Index 1018h is the Identity Object). As for all CAN data, the Index is stored with the bytes in reverse order. Example: Index 6040h means Byte 2 = 40h, Byte 3 = 60h)

3. Subindex (Byte 4):

The Subindex divides the parameters within a group of parameters.

4. Data field (Bytes 5 ... 8):

These components are used for the exchange of user data. In read-request telegrams to the S300/S700 they are set to 0. They have no content in a write confirmation from the S300/S700 if the transfer was successful, but if the write operation was faulty they contain an error code (→ # 24).

4.4.5.2 Initiate SDO Download Protocol

The Initiate SDO Download protocol is used for write access to objects with up to 4 bytes of user data (expedited transfer) or to initiate a segment transfer (normal transfer).

Expedited transfer is also used for objects that only have the character of a command (e.g. ASCII: SAVE) and thus do not require any further user data.

4.4.5.3 Download SDO Segment Protocol

The Download SDO Segment protocol is used for write access to objects with more than 4 bytes of user data (normal transfer). This service is not supported by S300/S700 at present, since there are no objects that make use of more than 4 bytes of user data.

4.4.5.4 Initiate SDO Upload Protocol

The SDO Upload protocol is used for read access to objects with up to 4 bytes of user data (expedited transfer) or to initiate a segment transfer (normal transfer).

4.4.5.5 Upload SDO Segment Protocol

The Upload SDO Segment protocol is used for read access to objects with more than 4 bytes of user data (normal transfer). This service is not supported by S300/S700 at present, since there are no objects that make use of more than 4 bytes of user data.

4.4.5.6 Abort SDO Protocol

The Abort SDO protocol breaks off SDO transmission, and indicates the error that caused the break in transmission through an abort code (error code). The error code is in the format of an UNSIGNED32 value. The following table shows possible reasons for an abort SDO.

Abort Code	Description
0601 0000h	Unsupported access to this object
0601 0001h	Attempted read access to a write-only object
0601 0002h	Attempted write access to a read-only object
0602 0000h	Object does not exist in Object Dictionary
0604 0041h	Object cannot be mapped to a PDO
0604 0042h	Size and number of mapped objects exceed permissible PDO length
0604 0043h	General parameter incompatibility
0607 0010h	Data type incompatible, length of service parameter is incompatible
0609 0011h	Subindex does not exist
0609 0030h	Outside value range for the parameter (only for write access)
0609 0031h	Parameter value too high
0609 0032h	Parameter value too low
0800 0020h	Data cannot be transmitted or saved
0800 0022h	Data cannot be transmitted or saved because of device status
FF03 0000h	OS cmd buffer full

Abort Codes not listed above are reserved.

4.4.6 Process Data Object (PDO)

PDOs are used for real-time data communication. PDOs can, for instance, be used to set up controllers similar to analog drives. Instead of +/-10VDC setpoints and ROD feedback, digital speed setpoints and position feedback are attained via PDOs in this case.

Transmission is carried out unconfirmed without a protocol "overhead". This communication object uses the unconfirmed communication service.

PDOs are defined via the Object Dictionary for the S300/S700. Mapping is made during the configuration phase, with the help of SDOs. Length is defined with the mapped objects.

The definition of the PDO service and protocol can be found in DS301. Examples of the usage of PDOs can be found in the appendix from page (→ # 93).

Basically, two types of PDOs can be distinguished, depending on the direction of transmission:

- Transmit-PDOs (TPDOs) (S300/S700 → Master)
The TPDOs transmit data from S300/S700 to control system (e.g actual value objects, instrument status).
- Receive-PDOs (RPDOs) (Master → S300/S700)
The RPDOs receive data from control system to S300/S700 (e.g setpoints).

S300/S700 supports four independent PDO channels for each direction of transmission. The channels are labeled by the channel numbers 1 to 4.

There are two parameter sets each for the configuration of each of the four possible PDOs, and they can be set up through the corresponding SDOs:

1. Mapping parameters, to determine which data are available (mapped) in the selected PDO and to define, which data are contained.
2. Communication parameters, that define whether the PDOs operate in synchronized mode, or event-driven (objects 1400h to 1403h, 1800h to 1803h).

4.4.6.1 Transmission modes

The following PDO transmission modes are distinguished:

- Synchronous transmission
- Asynchronous transmission

The pre-defined SYNC Object is transmitted periodically (bus clock), to synchronize the drives. Synchronous PDOs are transmitted within a pre-defined time window immediately following the SYNC Object.

The transmission modes are set up with the aid of the PDO communication parameters.

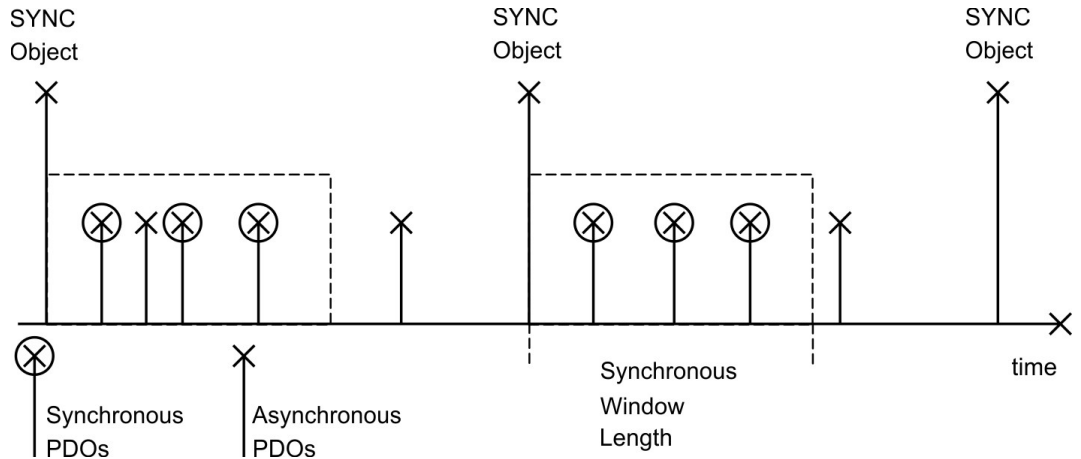

4.4.6.2 Trigger modes

Three different trigger modes are distinguished:

- **Event driven**
The transmission of the telegrams is triggered by an object-specific event.
- **Time driven**
If event driven signals put a high strain on the bus, you can determine the period of time after which a PDO can be transmitted again via the inhibit time (Communication parameter, sub-index 03h)
- **Event Timer driven**
If a PDO shall be sent within a defined time interval, even if it doesn't change, this interval can be defined by a special SDO.

4.4.7 Nodeguard

The Node Guarding protocol is a functional monitoring for the drive. It requires that the drive is accessed at regular intervals by the CANopen master.

The maximum time interval that is permitted between two Nodeguard telegrams is given by the product of the Guard Time (object 100Ch (→ # 33)) and the Life Time Factor (object 100Dh, (→ # 33)). If one of these two values is 0, then the response monitoring is de-activated.

If the drive is not accessed within the time defined by objects 100Ch and 100Dh, then Warning N04 (response monitoring) appears on the drive, the drive is braked to a stop with the quickstop ramp, and any other movement is prevented. (parameter DECSTOP, object 6085 sub0 (→ # 89)).

The time sequence for node guarding is as shown below:

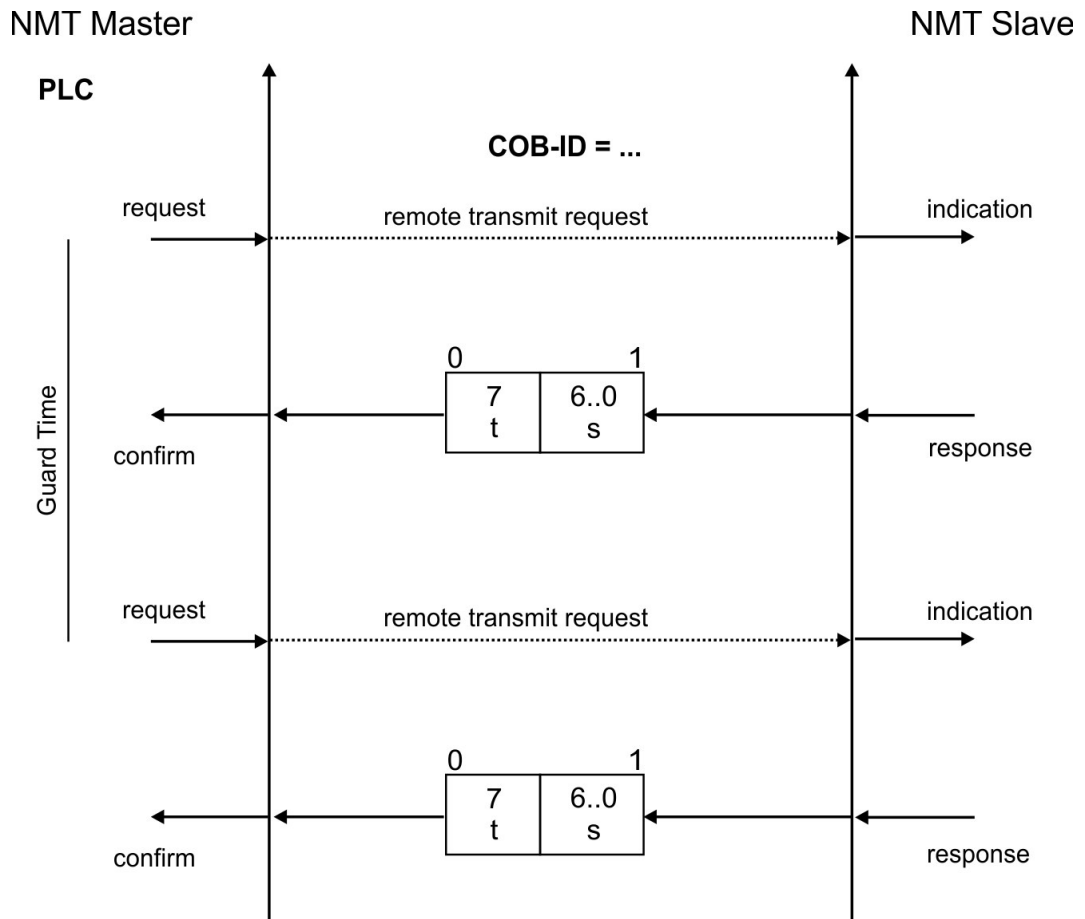

t = toggle Bit, changes its status with every slave telegram
 s = status of the NMT slave status machine

Node guarding is carried out by the Master through RTR telegrams with the COB-ID 700h + slave node address.

4.4.8 Heartbeat

The Heartbeat Protocol defines an Error Control Service without need for remote frames. A Heartbeat Producer transmits a Heartbeat message cyclically. One or more Heartbeat Consumer receive the indication. The relationship between producer and consumer is configurable via object 1016h (→ # 36) / 1017h (→ # 36).

The Heartbeat Consumer guards the reception of the Heartbeat within the Heartbeat Consumer Time. If the Heartbeat is not received within the Heartbeat Consumer Time a Heartbeat Event will be generated.

Heartbeat protocol:

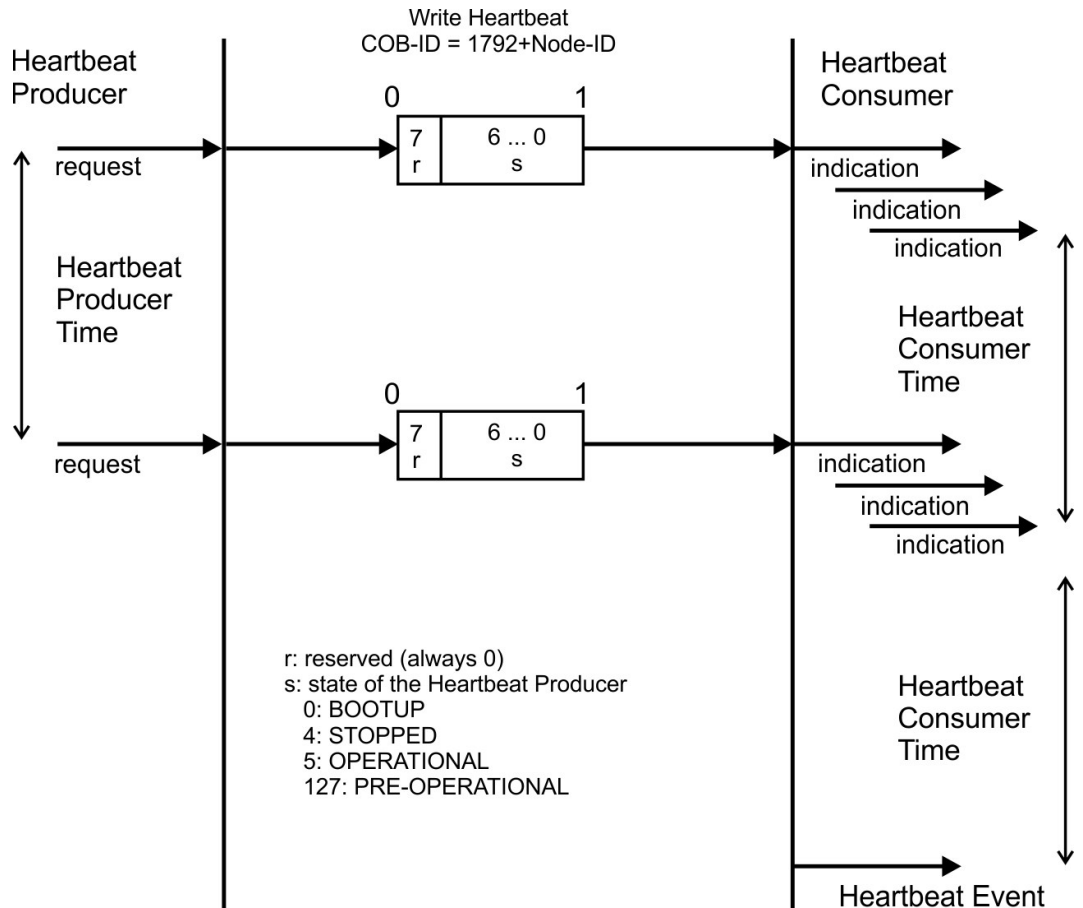

5 CANopen Drive Profile

5.1 Emergency Messages

Emergency messages are triggered by internal equipment errors. They have a high ID-priority, to ensure quick access to the bus. An Emergency message contains an error field with pre-defined error numbers (2 bytes), an error register (1byte), the error category (1 byte) and additional information (→ # 16). The higher-value byte of the error number describes the error category, and the lower-value byte provides the error number in this category. Error numbers from 0000h to 7FFFh are defined in the communication or drive profile. Error numbers from FF00h to FFFFh have manufacturer specific definitions. The error category can be used to classify the significance of any errors that occur. Defined error categories are:

1. Errors that can only be cleared by a reset (COLDSTART command, or Bit 7 in the control word (→ # 59). If you reset the amplifier in case of a cat.1 error, the servo amplifier will be restarted by a coldstart.
2. Errors that can be cleared by Bit 7 in the control word (→ # 59).
3. Error messages that may appear when a PDO is processed.
4. Errors, that **cannot** be cleared by the user.
5. Operating errors/warnings.

The cat. 1 and 2 errors are indicated by blinking of the LED display in the front panel.

Error Code	Category	Error number	Description
0000h	—	—	Error reset or no error (mandatory)
1000h	—	—	Generic error (mandatory)
1080h	5	—	No BTB/RTO (status not ready for operation)
2330h	2	F22	Error in ground connection
2380h	1	F12	Error in motor connection (phase fault)
3100h	2	F16	No mains/line-BTB
3110h	2	F02	Overvoltage in DC-bus/DC-link
3120h	2	F05	Undervoltage in DC-bus/DC-link
3130h	2	F19	Supply line phase missing (with PMODE = 2)
4110h	2	F13	Ambient temperature too high
4210h	1	F01	Heat sink temperature too high
4310h	1	F06	Motor temperature too high
5111h	1	F07	Fault in ±15V auxiliary voltage
5380h	1	F17	Fault in A/D converter
5400h	1	F14	Fault in output stage
5420h	1	F18	Ballast (chopper)
5441h	1	F27	Operating error for AS-option
5530h	1	F09	Serial EEPROM
6320h	3	—	Parameter error
7111h	1	F11	Braking error/fault
7122h	1	F25	Commutation error
7181h	5	—	Could not enable servo amplifier
7303h	1	F04	Feedback device error
7305h	1	F10	Signal failure digital encoder input
8182h	1	F23	CAN bus off
8331h	2	F15	I ² t (torque fault)
8480h	2	F08	Overspeed
8611h	2	n03/F03	Lag/following error
8681h	5	—	Invalid motion task number
FF01h	1	F32	Serious exception error
FF02h	3	—	Error in PDO elements
FF04h	1	F20	Slot error
FF05h	1	1	Handling error
FF06h	2	F24	Warning display as error
FF07h	2	F26	Homing error (drove onto HW limit switch)
FF08h	2	F29	Sercos error
FF11h	2	F30	Emergency timeout failure

5.2 General Definitions

This chapter describes objects with a general validity (e.g. Object 1000h Device Type). The next section explains the free configuration of Process Data Objects ("free mapping").

5.2.1 General Objects

5.2.1.1 Object 1000h: Device Type (DS301)

This object describes the device type (servo drive) and device functionality (DS402 drive profile).
Definition:

MSB				LSB	
Additional information			Device profile number		
Mode bits		Type		402d=192h	
31	24	23	16	15	0

The device profile number is DS402, the type is 2 for servo amplifiers, the mode bits 28 to 31 are manufacturer specific and may be changed from its actual value of 0. A read access delivers 0x00002192 at the moment.

Index	1000h
Name	device type
Object code	VAR
Data type	UNSIGNED32
Category	mandatory
Access	ro
PDO mapping	not possible
Value range	UNSIGNED32
Default value	no

5.2.1.2 Object 1001h: Error register (DS301)

This object is an error register for the device. The device can map internal errors into this byte. It is a part of an Emergency object.

Index	1001h
Name	Error register
Object code	VAR
Data type	UNSIGNED8
Category	mandatory
Access	ro
PDO mapping	not possible
Value range	UNSIGNED8
Default value	no

Error reasons to be signaled: If a bit is set to 1 the specified error has occurred. The generic error is signaled at any error situation.

Bit	Description	Bit	Description
0	generic error	4	communication error (overrun, error state)
1	current	5	device profile specific
2	voltage	6	reserved (always 0)
3	temperature	7	manufacturer specific

5.2.1.3 Object 1002h: Manufacturer Status Register (DS301)

The manufacturer status register contains important drive information.

Index	1002h
Name	Manufacturer Status Register
Object code	VAR
Data type	UNSIGNED32
Category	optional
Access	ro
PDO mapping	possible
Value range	UNSIGNED32
Default value	no

The following table shows the bit assignment for the status register:

Bit	Description	Bit	Description
0	1 = Movement (positioning, homing) active	16	1 = Homing move active
1	1 = reference point set	17	1 = Jog move active
2	1 = reference switch high (home-position)	18	1 = position latch at input 2 (negative transition)
3	1 = In Position	19	1 = Emergency stop active
4	1 = Position latch at input 2 (positive transition)	20	1 = Position latch at input 1 (positive transition)
5	reserved	21	1 = Position latch at input 1 (negative transition)
6	reserved	22	1 = Feed forward off
7	reserved	23	1 = Homing move finished
8	reserved	24	1 = one of the actual errors will lead to a coldstart of the drive, if resetted
9	reserved	25	1 = digital input 1 set
10	1 = Initialization phase finished	26	1 = digital input 2 set
11	reserved	27	1 = digital input 3 set
12	1 = Motor stand still message (threshold V _{EL0})	28	1 = digital input 4 set
13	1 = Safety relay selected (AS-option)	29	1 = digital input hardware enable set
14	1 = Power stage enabled	30	reserved
15	1 = Error state	31	reserved

5.2.1.4 Object 1003h: Predefined Error Field (DS301)

The object 1003h provides an error history with a maximum size of 8 entries.

Subindex 0 contains the number of errors which have occurred since the last reset of the error history, either by startup of the drive or resetting the error history by writing 0 to subindex 0.

A new Emergency-message is written into subindex 1 shifting the old entries one subindex higher. The old content of subindex 8 is lost.

The UNSIGNED32-information written to the subindexes is defined in the field Error Code in the description of the Emergency Messages (→ # 28).

Index	1003h
Name	pre-defined Error Field
Object code	ARRAY
Data type	UNSIGNED32
Category	optional
Subindex	0
Description	number of entries
Data type	UNSIGNED8
Category	mandatory
Access	rw
PDO mapping	not possible
Value range	0 to 8
Default value	0
Subindex	1 to 8
Description	Standard error field (→ # 28)
Category	optional
Access	ro
PDO mapping	not possible
Value range	UNSIGNED32
Default value	no

5.2.1.5 Object 1005h: COB-ID of the SYNC Message (DS301)

This object defines the COB-Id of the synchronisation object (SYNC).

Index	1005h
Name	COB-ID for the SYNC message
Object code	VAR
Data type	UNSIGNED32
Category	conditional
Access	rw
PDO mapping	not possible
Value range	UNSIGNED32
Default value	no

Bit coded information:

Bit	Value	Meaning
31 (MSB)	X	—
30	0	Device not generate SYNC message
	1	Device generates SYNC message
29	0	11 Bit ID (CAN 2.0A)
	1	29 Bit ID (CAN 2.0B)
28 to 11	X	if Bit 29=1 => Bit 11 ... 28 of 29-bit SYNC COB-ID
	0	if Bit 29=0
10 to 0 (LSB)	X	Bit 0 to 10 of SYNC COB-ID

The device does not support the generation of SYNC-messages and only the 11-bit IDs. So the bits 11 to 30 are always 0.

5.2.1.6 Object 1006h: Communication Cycle Period (DS301)

This object can be used to define the period (in μ s) for the transmission of the SYNC telegram.

Index	1006h
Name	Period of the communication cycle
Object code	VAR
Data type	UNSIGNED32
Category	Optional
Access	rw
PDO mapping	not possible
Value range	UNSIGNED32
Default value	00h

5.2.1.7 Object 1008h: Manufacturer Device Name (DS301)

The device name consists of four ASCII characters in the form S3xx, whereby xx stands for the power stage current.

Index	1008h
Name	Manufacturer Device Name
Object code	VAR
Data type	Visible String
Category	Optional
Access	const
PDO mapping	not possible
Value range	S301 - S3xx
Default value	no

5.2.1.8 Object 1009h: Manufacturer Hardware Version

The object gives the layout version of the drive.

Index	1009h
Name	manufacturer hardware version
Object code	VAR
Data type	Visible String
Category	Optional
Access	const
PDO mapping	not possible
Value range	-
Default value	no

5.2.1.9 Object 100Ah: Manufacturer Software Version (DS301)

The object contains the manufacturer software version (here: the CANopen-part of the drive firmware).

Index	100Ah
Name	Manufacturer Software Version
Object code	VAR
Data type	Visible String
Category	Optional
Access	const
PDO mapping	not possible
Value range	0.01 to 9.99
Default value	no

5.2.1.10 Object 100Ch: Guard Time (DS301)

The arithmetical product of the Objects 100Ch Guard Time and 100Dh Lifetime Factor is the response monitoring time. The Guard Time is given in milliseconds. The response monitoring is activated with the first Nodeguard object (→ # 26). If the value of the object Guard Time is set to zero, then the response monitoring is inactive.

Index	100Ch
Name	Guard Time
Object code	VAR
Data type	UNSIGNED16
Category	conditional; mandatory, if heartbeat not supported
Access	rw
PDO mapping	not possible
Value range	UNSIGNED16
Default value	0

5.2.1.11 Object 100Dh: Lifetime Factor (DS301)

The product of Guard Time and Life Time Factor gives the life time for the nodeguarding protocol. If it's 0, the protocol is not used.

Index	100Dh
Name	Lifetime Factor
Object code	VAR
Data type	UNSIGNED8
Category	conditional; (mandatory, if heartbeat not supported)
Access	rw
PDO mapping	not possible
Value range	UNSIGNED8
Default value	0

5.2.1.12 Object 1010h: Store Parameters (DS301)

This object supports the saving of parameters to a flash EEPROM. Only the subindex 1 for saving of all parameters, which can also be saved in the parameter files via the GUI, is supported.

Index	1010h
Name	store parameters
Object code	ARRAY
Data type	UNSIGNED32
Category	optional

Subindex	0
Name	number of entries
Object code	VAR
Data type	UNSIGNED8
Category	mandatory
Access	ro
PDO Mapping	not possible
Value range	1
Default value	1

Subindex	1
Name	save all parameters
Object code	VAR
Data type	UNSIGNED32
Category	mandatory
Access	rw
PDO Mapping	not possible
Value range	UNSIGNED32
Default value	1

Data definition:

Bit	Value	Meaning
31 to 2	0	reserved (=0)
1	0	Device does not save parameters autonomously
	1	Device does save parameters autonomously
0	0	Device does not save parameters on command
	1	Device does save parameters on command

By read access to subindex 1 the drive provides information about its storage functionality.

This drive provides a constant value of 1 by read access, i.e. all parameters can be saved by writing to Object 1010 sub 1. In general the drive does not save parameters autonomously with the exception of e.g. the special treatment of the homing of multiturn absolute encoders.

Storing of parameters is only done if a special signature ("save") is written to subindex 1. "save" is equivalent to the unsigned32 - number 65766173h.

5.2.1.13 Object 1011h: Restore Default Parameters DS301

With this object the default values of parameters according to the communication or device profile are restored. The S300/S700 gives the possibility to restore all default values.

Index	1011h
Name	restore default parameters
Object code	ARRAY
Data type	UNSIGNED32
Category	optional

Subindex	0
Name	number of entries
Object code	VAR
Data type	UNSIGNED8
Category	mandatory
Access	ro
PDO Mapping	not possible
Value range	1
Default value	1

Subindex	1
Name	restore all default parameters
Object code	VAR
Data type	UNSIGNED32
Category	mandatory
Access	rw
PDO Mapping	not possible
Value range	UNSIGNED32
Default value	1 (device restores parameter)

Restoring default parameters to the RAM will be done, if a special signature ("load") is written to subindex 1. "load" has to be transmitted as unsigned32 - number 64616F6Ch.

5.2.1.14 Object 1014h: COB-ID for Emergency Message (DS301)

This object defines the COB-ID of the Emergency message.

Index	1014h
Name	COB-ID emergency message
Object code	VAR
Data type	UNSIGNED32
Category	conditional; mandatory, if Emergency is supported
Access	rw
PDO mapping	not possible
Value range	UNSIGNED32
Default value	80h + Node - ID

5.2.1.15 Object 1016h: Consumer Heartbeat Time

The consumer heartbeat time defines the expected heartbeat cycle time and has to be higher than the corresponding producer heartbeat time configured on the device producing this heartbeat. Monitoring starts after the reception of the first heartbeat. If the consumer heartbeat time is 0 the corresponding entry is not used. The time is defined in milliseconds.

Index	1016h
Name	consumer heartbeat time
Object code	ARRAY
Data type	UNSIGNED32
Category	optional
Subindex	0
Description	number of entries
Data type	UNSIGNED8
Category	mandatory
Access	ro
PDO Mapping	not possible
Value range	1
Default value	1
Subindex	1
Description	Consumer heartbeat time
Category	mandatory
Access	rw
PDO Mapping	not possible
Value range	unsigned 32
Default value	0

Definition of the entry value of Subindex 1

	MSB				LSB
Value	reserved (value: 00)		Node-ID		heartbeat time
Encoded as	-		UNSIGNED8		UNSIGNED16
Bit	31	24	23	16	15
					0

5.2.1.16 Object 1017h: Producer Heartbeat Time

The producer heartbeat time defines the cycle time of the heartbeat in ms. If it's 0, it is not used.

Index	1017h
Name	Producer heartbeat time
Object code	VAR
Data type	UNSIGNED16
Category	conditional; mandatory, if guarding is not supported
Access	rw
PDO mapping	not possible
Value range	UNSIGNED16
Default value	0

5.2.1.17 Object 1018h: Identity Object (DS301)

The Identity Object contains general device information.

Index	1018h
Name	Identity Object
Object code	RECORD
Data type	Identity
Category	mandatory

Subindex	0
Description	number of entries
Data type	UNSIGNED8
Category	mandatory
Access	ro
PDO mapping	not possible
Value range	1 to 4
Default value	4

Subindex 1 is a unique number for a device manufacturer.

Subindex	1
Description	Vendor ID
Category	mandatory
Access	ro
PDO mapping	not possible
Value range	UNSIGNED32
Default value	0x6Ah (Kollmorgen)

Subindex 2 contains the general device number including dc-bus-voltage and current class.

Subindex	2
Description	Product Code
Category	optional
Access	ro
PDO mapping	not possible
Value range	301 ... 346
Default value	no

Subindex 3 consists of two revision numbers:

- the major revision number in the upper word containing the CAN-version
- the minor revision number containing the general firmware version

E.g. a value of 0x0022 0079 means CAN-version 0.34 and firmware version 1.21.

Subindex	3
Description	Revision Number
Category	optional
Access	ro
PDO mapping	not possible
Value range	UNSIGNED32
Default value	no

Subindex 4 gives the serial number of the drive.

Subindex	4
Description	Serial Number
Category	optional
Access	ro
PDO mapping	not possible
Value range	UNSIGNED32
Default value	no

5.2.1.18 Object 1026h: OS Prompt

The OS prompt is used to build up an ASCII - communication channel to the drive.

Index	1026h
Name	OS Prompt
Object code	ARRAY
Data type	UNSIGNED8
Category	optional

Subindex	0
Description	number of entries
Data type	UNSIGNED8
Category	mandatory
Access	ro
PDO mapping	not possible
Value range	2
Default value	2

Subindex 1 is used to send one character to the drive.

Subindex	1
Description	StdIn
Category	mandatory
Access	ro
PDO mapping	possible
Value range	UNSIGNED8
Default value	—

Subindex 2 is used to receive one character from the drive.

Subindex	2
Description	StdOut
Category	mandatory
Access	w
PDO mapping	possible
Value range	UNSIGNED8
Default value	0

5.2.1.19 Object 2000h: Manufacturer Warnings

This object provides information about drive internal warnings.

Index	2000h
Name	Manufacturer Warnings
Object code	VAR
Data type	UNSIGNED32
Category	optional
Access	ro
PDO mapping	possible
Value range	UNSIGNED32
Default value	-

Bit coded warnings:

Bit	Meaning
0	n01 - I2t - threshold exhausted
1	n02 -regen power reached preset regen power limit
2	n03* - contouring error exceeded preset limit
3	n04* - nodeguarding monitoring has been activated
4	n05 -Mains supply phase missing
5	n06* - position fall below software limit switch 1
6	n07* - position exceeded software limit switch 2
7	n08 -faulty motion task
8	n09 -no reference point at start of motion task
9	n10* -PSTOP limit-switch activated
10	n11* -NSTOP limit-switch activated
11	n12 -only for ENDAT or HIPERFACE®: discrepancy between motor number saved in the encoder and the amplifier, motor default values loaded
12	n13* -expansion card not operating correctly
13	n14 -SinCos commutation (wake & shake) not completed, will be canceled automatically when amplifier is enabled and wake & shake carried out
14	n15 -table error fault according to speed/current table (with INXMODE 35)
15	n16 -Summarized warning for n17 to n31
16	n17 -CAN-Sync is not logged in (with SYNCSRC = 3)
17	n18 -Multiturn overflow: Max. number of turns exceeded
18 to 30	n19-n31: reserved
31	n32 -firmware is an unreleased beta version

* = these warning messages result in a controlled shut-down of the drive (braking by emergency stop ramp)

5.2.1.20 Object 2014-2017h: 1st-4th Mask 1 to 4 for Transmit-PDO

In order to reduce the bus loading with event-triggered PDOs, masking can be used to switch off the monitoring for individual bits in the PDO. In this way it can be arranged, for instance, that actual position values are only signaled once per turn.

This Object masks the PDO-channels 1 to 4. If only two bytes have been defined in a PDO, then it masks just two bytes, although 4 bytes of mask information have been transmitted.

An activated bit in the mask means that monitoring is active for the corresponding bit in the PDO.

Index	2014h, 2015h, 2016h, 2017h
Name	tx_mask 1 to 4
Object code	ARRAY
Data type	UNSIGNED32
Subindex	1
Description	tx_mask1 to 4_low
Mode	independent
Access	rw
PDO mapping	not possible
Unit	—
Value range	UNSIGNED32
Default value	FFFFFFFFh
Subindex	2
Description	tx_mask1 to 4_high
Mode	independent
Access	rw
PDO mapping	not possible
Unit	—
Value range	UNSIGNED32
Default value	FFFFFFFFh

5.2.1.21 Object 2030h: DP-RAM Variables (write only)

Index	2030h
Name	DP-Ram Variables, write only (PDO)
Object code	ARRAY
Data type	INTEGER32
Category	optional
Subindex	0
Description	Number of entries
Data type	UNSIGNED8
Category	optional
Access	ro
PDO mapping	not possible
Value range	9
Default value	9
Subindex	1...8
Description	DP-Ram Variables 9...16
Category	optional
Access	rw
PDO mapping	possible
Value range	INTEGER32
Default value	0

5.2.1.22 Object 2040h: Gearing factor for electronic gearing

This object defines the gearing factor for the electronic gearing between a master and a slave drive, which are connected via ROD. These objects are relevant only for the OPMODE 4 respectively the CANopen mode 0x84.

Index	2040h
Name	Electronic gearing factor
Object code	RECORD
Category	optional
Subindex	0
Description	Number of entries
Data type	UNSIGNED8
Category	optional
Access	ro
PDO mapping	not possible
Value range	2
Default value	2

Subindex 1 is related to the master input signal depending on selected feedback and GEARMODE.

Subindex	1
Description	Gearing Input
Category	optional
Access	rw
PDO mapping	possible
Value range	INTEGER32
Default value	1024

Subindex 2 gives the movement of the slave in dependency of the master pulses.

Subindex	2
Description	Gearing Output
Category	optional
Access	rw
PDO mapping	possible
Value range	UNSIGN32ED
Default value	1

5.2.1.23 Object 2041h: Electric gearing actual value

This object is used to display the input master speed, the internal slave setpoint speed as a control variable for the slave of the electric gearing, and the internal control word for enabling/disengaging synchronisation of the electric gearing.

For a usage example of the electric gearing (→ # 130).

Index	2041h
Name	Electric gearing actual value
Object code	RECORD
Category	optional
Subindex	0
Description	Number of entries
Data type	UNSIGNED8
Category	optional
Access	ro
PDO mapping	not possible
Value range	3
Default value	3

Subindex 1 displays the internal setpoint speed determined from the master speed using the transmission ratio (object 2040h).

Subindex	1
Description	Slave velocity set point
Category	optional
Access	ro
PDO mapping	possible
Value range	INTEGER32
Default value	0

Subindex 2 shows the determined master speed.

Subindex	2
Description	Master velocity of electric gearing
Category	optional
Access	ro
PDO mapping	possible
Value range	INTEGER32
Default value	0

Subindex 3 displays the synchronisation status (engaged/disengaged) of the slave axis of the electric gearing. For an explanation (→ # 130).

Subindex	3
Description	Internal control word for electric gearing
Category	optional
Access	ro
PDO mapping	possible
Value range	0, 1, 2, 5, 6
Default value	0

5.2.1.24 Object 2051h: Configuration of Position Registers

This object is used to enable and set the trigger type and the polarity of the 16 position registers. Objects 2052h and 2053h are used to specify whether the absolute position, or the position relative to the actual position should be evaluated.

Index	2051h
Name	Configuration of Position Registers
Object code	ARRAY
Data type	UNSIGNED32
Category	optional

Subindex	0
Description	Number of entries
Data type	UNSIGNED8
Category	optional
Access	ro
PDO mapping	not possible
Value range	3
Default value	3

Using subindex 1, the position registers 16 P1 .. P16 can be individually enabled or locked via the assigned bits 0..15. The position register is locked by setting the relevant bit.

Subindex	1
Description	Enable position registers
Category	optional
Access	rw
PDO mapping	possible
Value range	0..65535
Default value	0

Subindex 2 defines the trigger type of the 16 position registers P1 - P16. If the corresponding bit is set to 0, the position is constantly monitored. If it is set to 1, after the position register is activated, the corresponding enable bit from subindex 1 is reset and monitoring is thus switched off.

Subindex	2
Description	Position register mode
Category	optional
Access	rw
PDO mapping	possible
Value range	0..65535
Default value	0

Subindex 3 is used to set the polarity for the monitoring of the 16 position registers P1 - P16. If it is set to 0, overshooting of the position is monitored, if it is set to 1, the undershoot of the position of the corresponding position register is monitored.

Subindex	3
Description	Position register polarity
Category	optional
Access	rw
PDO mapping	possible
Value range	0..65535
Default value	0

5.2.1.25 Object 2052h: Position Registers, absolute

This object is used to enter the values of the 16 position registers P1 - P16 as absolute positions.

Index	2052h
Name	Position registers, absolute
Object code	ARRAY
Data type	INTEGER32
Category	optional

Subindex	0
Description	Number of entries
Data type	UNSIGNED8
Category	optional
Access	ro
PDO mapping	not possible
Value range	16
Default value	16

The subindexes 1 to 16 are used to contact the positions of the position registers P1...P16 to be monitored.

Subindex	1...16
Description	Position registers 1..16, absolute
Category	optional
Access	rw
PDO mapping	possible
Value range	INTEGER32
Default value	0

5.2.1.26 Object 2053h: Positions Registers, relative

This object is used to enter the values of the 16 position registers P1 - P16 as positions relative to the current actual position.

Index	2053h
Name	Position registers, relative
Object code	ARRAY
Data type	INTEGER32
Category	optional

Subindex	0
Description	Number of entries
Data type	UNSIGNED8
Category	optional
Access	ro
PDO mapping	not possible
Value range	16
Default value	16

The subindexes 1 to 16 are used to contact the positions of the position registers P1...P16 to be monitored.

Subindex	1...16
Description	Positions registers 1..16, relative
Category	optional
Access	rw
PDO mapping	possible
Value range	INTEGER32
Default value	0

5.2.1.27 Object 2061h: Current limitation for velocity mode

This object is used for rapid current limitation in velocity mode (0x3). A value of 3280 represents the maximum device current that can be queried using DIPEAK. This object acts on the ASCII parameter DPRILIMIT. In order to be effective, the configuration parameter DILIM must be set to 1.

Index	2061h
Name	Current limitation in velocity mode
Object code	VAR
Data type	UNSIGNED16
Category	optional
Access	rw
PDO mapping	possible
Value range	0 .. 3280
Default value	0

5.2.1.28 Object 2080h: Motion Task Select

This object is an extension to the profile position mode. If the value of the object is not 0, the addressed motion task will be started with the next rising flank of the "New setpoint" bit of the control word (bit 4), if the bit "Change Set Immediately" (bit 5) is set. After the motion task is started, the value of the object will be reset automatically to 0.

Index	2080h
Name	Motion tasks in PP-Mode
Object code	VAR
Data type	INTEGER16
Category	optional
Access	rw
PDO mapping	possible
Value range	1 to 300
Default value	0

5.2.1.29 Object 2081h: Active Motion Task Display

This object shows the last motion task, which has been started in the drive. Motion tasks numbers from 1 to 200 show Flash-EEPROM motion tasks, numbers from 201 to 300 show RAM-motion tasks. If there is no value in object 2080h and a motion task is started via the new-setpoint / setpoint acknowledge mechanism of the profile position mode, motion task 0 will be used and shown.

If you start a set of stored motion tasks (bit 3 of the motion task control word O_C, Object 35B9 sub1 set), the active motion task will be shown in this object.

Index	2081h
Name	Active Motion Task Display
Object code	VAR
Data type	UNSIGNED16
Category	optional
Access	rw
PDO mapping	possible
Value range	1...300
Default value	0

5.2.1.30 Object 2082h: Copy motion tasks

With the help of this object motion tasks can be copied in the drive. The motion task addressed in the low word is copied to the motion task addressed in the high word.

NOTE

EEPROM motion task between 1 and 200 can be written only if the power stage is disabled!

Index	2082h
Name	Copy motion tasks
Object code	VAR
Data type	UNSIGNED32
Category	optional
Access	wo
PDO mapping	not possible
Value range	High Word: 0 .. 300, low word: 0 .. 300
Default value	-

5.2.1.31 Object 2083h: Delete Motion tasks

This object gives the possibility to delete all Flash-EEPROM motion tasks. This action is only been taken, if a special signature ("prom") is written.

"prom" has to be transmitted as unsigned32 - number 6D6F7270h.

Deletion is only possible if the power stage is disabled and the NMT-state is PREOPERATIONAL.

Index	2083h
Name	delete motion tasks
Object code	VAR
Data type	UNSIGNED32
Category	optional
Access	wo
PDO mapping	not possible
Value range	UNSIGNED32
Default value	-

5.2.1.32 Object 2090h: DP-RAM Variables (read only)

Index	2090h
Name	DP-Ram Variables, read only (PDO)
Object code	ARRAY
Data type	INTEGER32
Category	optional
Subindex	0
Description	Number of entries
Data type	UNSIGNED8
Category	optional
Access	ro
PDO mapping	not possible
Value range	9
Default value	9
Subindex	1..8
Description	DP-Ram Variables 9...16
Category	optional
Access	ro
PDO mapping	possible
Value range	INTEGER32
Default value	0

5.2.1.33 Object 20A0h: Latch position 1, positive edge

This object is used to output the position at which the first positive edge occurred on digital input 1 following latch enable (also see object 20A4). Output reactivates the latch mimic for a process. Prerequisite is the configuration of input 1 as a latch input (IN1MODE 26).

Index	20A0h
Name	Latch position 1 positive edge
Object code	VAR
Data type	INTEGER32
Category	optional
Access	ro
PDO mapping	possible
Value range	INTEGER32
Default value	0

5.2.1.34 Object 20A1h: Latch position 1, negative edge

This object is used to output the position at which the first negative edge occurred on digital input 1 following latch enable (also see object 20A4). Output reactivates the latch mimic for a process. Prerequisite is the configuration of input 1 as a latch input (IN1MODE 26).

Index	20A1h
Name	Latch position 1 negative edge
Object code	VAR
Data type	INTEGER32
Category	optional
Access	ro
PDO mapping	possible
Value range	INTEGER32
Default value	0

5.2.1.35 Object 20A2h: Latch position 2, positive edge

This object is used to output the position at which the first positive edge occurred on digital input 2 following latch enable (also see object 20A4). Output reactivates the latch mimic for a process. Prerequisite is the configuration of input 2 as a latch input (IN2MODE 26).

Index	20A2h
Name	Latch position 2 positive edge
Object code	VAR
Data type	INTEGER32
Category	optional
Access	ro
PDO mapping	possible
Value range	INTEGER32
Default value	0

5.2.1.36 Object 20A3h: Latch position 2, negative edge

This object is used to output the position at which the first negative edge occurred on digital input 2 following latch enable (also see object 20A4). Output reactivates the latch mimic for a process. Prerequisite is the configuration of input 2 as a latch input (IN2MODE 26).

Index	20A3h
Name	Latch position 2 negative edge
Object code	VAR
Data type	INTEGER32
Category	optional
Access	ro
PDO mapping	possible
Value range	INTEGER32
Default value	0

5.2.1.37 Object 20A4h: Latch Control Register

The latch control register is used to enable the latch monitoring of digital inputs 1 and 2. The latch is enabled with a 1 signal and locked with a 0 signal. Whether or not a latch event has occurred can be recognized by the manufacturer status (see table), object 1002.

Index	20A4h	
Name	Latch Control Register	
Object code	VAR	
Data type	UNSIGNED8	
Category	optional	
Access	rw	
PDO mapping	possible	
Value range	0 to 15	
Default value	0	

Bit	Edge	Bit in Object 1002
0	Enable positive edge on digital input 1	20
1	Enable negative edge on digital input 1	21
2	Enable positive edge on digital input 2	4
3	Enable negative edge on digital input 2	18
4 to 7	reserved	

5.2.1.38 Object 20B0h: Trigger Variable Digital Input 20

This object can be used to set the trigger variable for the software input 20. This object, which can also be mapped, can be used for the start/stop procedure in the electric gearing (if IN20MODE = 51 or 53).

Index	20B0h
Name	Trigger variable digital input 20
Object code	VAR
Data type	INTEGER32
Category	optional
Access	rw
PDO mapping	possible
Value range	INTEGER32
Default value	0

5.2.1.39 Object 20B1h: Control Word Digital Inputs 5...20

The lower 16 bits of this object can be used to control the digital software inputs 5 to 20.

Index	20B1h
Name	Control word digital inputs 5 .. 20
Object code	VAR
Data type	UNSIGNED32
Category	optional
Access	rw
PDO mapping	possible
Value range	0..65535
Default value	0

5.2.1.40 Object 20B2h: Analog Inputs

This object can be used to input the voltages of analog inputs 1 and 2.

Index	20B2h
Name	Analog Inputs
Object code	ARRAY
Data type	INTEGER16
Category	optional

Subindex	0
Description	Number of entries
Data type	UNSIGNED8
Category	optional
Access	ro
PDO mapping	not possible
Value range	2
Default value	2

Subindex 1 returns the digital value of analog input 1 (10 V ~ 2000h).

Subindex	1
Description	Voltage analog input 1
Category	optional
Access	ro
PDO mapping	possible
Value range	INTEGER16
Default value	-

Subindex 2 returns the digital value of analog input 2 (10 V ~ 2000h).

Subindex	2
Description	Voltage analog input 2
Category	optional
Access	ro
PDO mapping	possible
Value range	INTEGER16
Default value	-

5.2.1.41 Object 2100h: Write Dummy

Index	2100h
Name	Write-Dummy variables for mapping
Object code	RECORD
Data type	UNSIGNED32
Category	optional
Access	rw
PDO mapping	possible
Value range	UNSIGNED32
Default value	1

5.2.1.42 Object 2101h: Read Dummy

Index	2101h
Name	Read-Dummy variables for mapping
Object code	RECORD
Data type	UNSIGNED32
Category	optional
Access	ro
PDO mapping	possible
Value range	UNSIGNED32
Default value	1

5.2.1.43 Object 60FDh: Digital inputs (DS402)

This index defines simple digital inputs for drives. The bits 0 to 2 can be supported by the drive, if the needed function is configured to the digital inputs with the ASCII - commands INxMODE (x may be 1 to 4), e.g. IN3MODE = 2, PSTOP - function, see Online Help).

Index	60FDh							
Name	digital inputs							
Object code	VAR							
Data type	UNSIGNED32							
Category	optional							
Access	ro							
PDO mapping	possible							
Value range	UNSIGNED32							
Default value	0							
	31	16	15	4	3	2	1	0
	manufacturer specific		reserved		enable	home switch	limit switch +	limit switch -
	MSB							LSB

The switch have to be "active high".

5.2.1.44 Object 6502h: Supported drive modes (DS402)

A drive can support more than one and several distinct modes of operation. This object gives an overview of the implemented operating modes in the device. This object is read only.

Index	6502h										
Name	supported drive modes										
Object code	VAR										
Data type	UNSIGNED32										
Category	optional										
Access	ro										
PDO mapping	possible										
Value range	UNSIGNED32										
Default value	0x6D (ip hm tq pv pp)										
31	16	15	7	6	5	4	3	2	1	0	
manufacturer specific		reserved		ip	hm	reserved	tq	pv	vl	pp	
MSB											LSB

5.3 PDO Configuration

PDOs are used for process data communication. There are distinguished two types of PDOs: Receive PDOs (RPDOs) and transmit PDOs (TPDOs).

The content of the PDOs is pre-defined (see descriptions on pages (→ # 52) and (→ # 54)). If the data content is not appropriate for a special application the data objects in the PDOs can be remapped freely.

One data entry in the PDOs looks like this:

MSB		LSB
index (16 bit)	sub-index (8 bit)	data length in bits (8 bit)

The configuration procedure for a free mapping of a PDO looks like this (example for TPDO1):

1. Delete the actual mapping of the PDO by writing a 0 to the sub 0 of the mapping Object

COB-ID	Control byte	Index		Sub-index	Data	Comment
		Low byte	High byte			
601	2F	00	1A	00h	00 00 00 00	Delete actual mapping

2. Build the mapping with object dictionary objects (→ # 104) which are mappable, e.g.

COB-ID	Control byte	Index		Sub-index	Data	Comment
		Low byte	High byte			
601	23	00	1A	01h	10 00 41 60	1st entry: CANopen status-word with 16 bits
601	23	00	1A	02h	20 00 02 10	2nd entry: Manufacturer status with 32 bits

3. Write the number of mapped objects to subindex 0 of the mapping Object.

COB-ID	Control byte	Index		Sub-index	Data	Comment
		Low byte	High byte			
601	2F	00	1A	00h	02 00 00 00	Check for the right number of entries

Mapping shall be done before the network management is switched to OPERATIONAL.

5.3.1 Receive PDOs (RXPDO)

Four Receive PDOs can be configured in the servo amplifier:

- configuration of the communication (Objects 1400-1403h)
- configuration of the PDO-contents (mapping, Objects 1600-1603h)

5.3.1.1 Objects 1400-1403h: 1st - 4th RxPDO communication parameter (DS301)

Index	1400h, 1401h, 1402h, 1403h for RXPDO 1 ... 4
Name	receive PDO parameter
Object code	RECORD
Data type	PDO CommPar
Category	mandatory

Defined sub-indices

Subindex	0
Name	number of entries
Data type	UNSIGNED8
Category	mandatory
Access	ro
PDO Mapping	not possible
Value Range	2
Default Value	2
Subindex	1
Name	COB-ID used by PDO
Category	mandatory
Access	rw
PDO Mapping	not possible
Value Range	UNSIGNED32
Default Value	Index 1400h: 200h + Node-ID Index 1401h: 300h + Node-ID Index 1402h: 400h + Node-ID Index 1403h: 500h + Node-ID

Subindex 1 contains the COB-Id of the PDO as a bit coded information:

Bit	Value	Meaning
31	0	PDO exists / is valid
	1	PDO does not exist / is not valid
30	0	RTR allowed on this PDO, not to be used (Can in Automation organization)
	1	RTR not allowed on this PDO
29	0	11 bit-ID (CAN 2.0A)
	1	29 bit-ID (CAN 2.0B), not supported
28 to 11	X	Identifier-bits with 29 bit-ID, not relevant
	0	if bit 29=0
10 to 0	X	Bits 10-0 of COB-ID

Subindex 2 contains the transmission type of the PDO. There are two ways of setting:

- the value FFh or 255 for event-triggered PDO, which is directly interpreted by reception and taken into actions,
- values from 0 to 240, which cause a SYNC-telegram-controlled interpretation of the PDO contents. Values of 1 to 240 mean, that 0 to 239 SYNC-telegrams are ignored, before one is interpreted. The value 0 means, that only the next SYNC-telegram is interpreted.

5.3.1.2 Objects 1600-1603h: 1st - 4th RxPDO mapping parameter (DS301)

Index	1600h, 1601h, 1602h, 1603h for RxPDO 1 to 4.
Name	receive PDO mapping
Object Code	RECORD
Data Type	PDO Mapping
Category	mandatory
Subindex	0
Name	number of entries
Data type	UNSIGNED8
Category	mandatory
Access	rw
PDO Mapping	not possible
Value Range	0: PDO is not active 1 - 8: PDO activated, mappings are taken only byte-wise
Default Value	PDO1: 1, PDO2: 2, PDO3: 2, PDO4: 2
Subindex	1 - 8
Name	PDO - mapping for the n-th application object
Category	Conditional, depends on number and size of object be mapped
Access	rw
PDO Mapping	not possible
Value Range	UNSIGNED32
Default Value	See below

5.3.1.3 Default RXPDO definition

RXPDO 1:

Subindex	Value	Meaning
0	1	One PDO-mapping entry
1	60 40 00 10	Controlword

RXPDO 2:

Subindex	Value	Meaning
0	2	Two PDO-mapping entries
1	60 40 00 10	Controlword
2	60 60 00 08	Modes of Operation

RXPDO 3:

Subindex	Value	Meaning
0	2	Two PDO-mapping entries
1	60 40 00 10	Controlword
2	60 7A 00 20	Target Position (Mode PP)

RXPDO 4:

Subindex	Value	Meaning
0	2	Two PDO-mapping entries
1	60 40 00 10	Controlword
2	60 FF 00 20	Target Velocity (Mode PV)

5.3.2 Transmit PDOs (TXPDO)

Four Transmit PDOs can be configured in the servo amplifier:

- configuration of the communication (Objects 1800-1803h)
- configuration of the PDO-contents (mapping, Objects 1A00-1A03h)

5.3.2.1 Objects 1800-1803h: 1st - 4th TxPDO communication parameter (DS301)

Index	1800h, 1801h, 1802h, 1803h for TxPDO 1 to 4.
Name	transmit PDO parameter
Object code	RECORD
Data type	PDO CommPar
Category	mandatory
Subindex	0
Name	number of entries
Data type	UNSIGNED8
Category	mandatory
Access	ro
PDO Mapping	not possible
Value Range	5
Default Value	5
Subindex	1
Name	COB-ID used by PDO
Category	mandatory
Access	rw
PDO Mapping	not possible
Value Range	UNSIGNED32
Default Value	Index 1800h: 40000180h + Node-ID Index 1801h: 40000280h + Node-ID Index 1802h: 40000380h + Node-ID Index 1803h: 40000480h + Node-ID
Subindex	2
Name	transmission type
Category	mandatory
Access	rw
PDO Mapping	not possible
Value Range	UNSIGNED8
Default Value	FFh
Subindex	3
Name	inhibit time
Category	optional
Access	rw
PDO Mapping	not possible
Value Range	UNSIGNED16 (n*1/10ms)
Default Value	0h

Subindex	4
Name	reserved
Category	optional
Access	rw
PDO Mapping	not possible
Value Range	0
Default Value	0

Subindex	5
Name	event timer
Category	optional
Access	rw
PDO Mapping	not possible
Value Range	UNSIGNED16 (0=not used, n*1/10ms)
Default Value	0h

Subindex 1 contains the COB-Id of the PDO as a bit coded information:

Bit	Value	Meaning
31	0	PDO exists / is valid
	1	PDO does not exist / is not valid
30	0	RTR allowed on this PDO, supported from Firmware 3.00
	1	RTR not allowed on this PDO. This bit must be set from FW 3.00, because RTR access to Tx-PDOs is generally not supported.
29	0	11 bit-ID (CAN 2.0A)
	1	29 bit-ID (CAN 2.0B), not supported
28 to 11	X	Identifier-bits with 29 bit-ID, not relevant
	0	If bit 29=0
10 to 0	X	Bits 10-0 of COB-ID

Subindex 2 contains the transmission type of the PDO. There are two ways of setting:

- a value of FFh or 255 for an event-triggered PDO, which is sent immediately after a change in the mapped application objects. Setting of sub-index 3 or 5 has an influence on the sending of a PDO.
 - With sub-index 3 you can configure, in which minimal time the so configured Transmit-PDOs are sent, if PDO-data contents change (reduction of bus-load).
 - With sub-index 5 (event time) a timer is used, which is resetted with every event-triggered sending of this PDO. If there is no change of the PDO-content in this time, the PDO is sent caused by this timer event.
- values from 0 to 240 cause a SYNC-Telegram controlled sending of the PDO. Values of 1 to 240 define how often the SYNC-telegram leads to a sending of a PDO. The value 0 means, that only the next SYNC-telegram leads to a sending of the so configured PDOs.

5.3.2.2 Objects 1A00-1A03h: 1st - 4th TxPDO mapping parameter (DS301)

Index	1A00h, 1A01h, 1A02h, 1A03h for TxPDO 1 to 4.
Name	transmit PDO mapping
Object Code	RECORD
Data Type	PDO Mapping
Category	mandatory
Subindex	0
Name	number of mapped application objects in PDO
Data type	UNSIGNED8
Category	mandatory
Access	rw
PDO Mapping	not possible
Value Range	0: PDO is not active 1 - 8: PDO activated, mappings are taken only byte-wise
Default Value	PDO1: 1, PDO2: 2, PDO3: 2, PDO4: 2
Subindex	1 - 8
Name	PDO - mapping for the n-th application object
Category	Conditional, depends on number and size of object be mapped
Access	rw
PDO Mapping	not possible
Value Range	UNSIGNED32
Default Value	See below

5.3.2.3 Default TXPDO definition

TXPDO 1:

Subindex	Value	Meaning
0	1	One PDO-mapping entry
1	60 41 00 10	Statusword

TXPDO 2:

Subindex	Value	Meaning
0	2	Two PDO-mapping entries
1	60 41 00 10	Statusword
2	60 61 00 08	Modes of Operation display

TXPDO 3:

Subindex	Value	Meaning
0	2	Two PDO-mapping entries
1	60 41 00 10	Statusword
2	60 64 00 20	Position actual value

TXPDO 4:

Subindex	Value	Meaning
0	2	Two PDO-mapping entries
1	60 41 00 10	Statusword
2	60 6C 00 20	Velocity actual value

5.4 Device control (dc)

The device control of the S300/S700 can be used to carry out all the motion functions in the corresponding modes. The control of the S300/S700 is implemented through a mode-dependent status machine. The status machine is controlled through the control word (→ # 59).

The mode setting is made through the object "Modes of Operation" (→ # 104). The states of the status machine can be revealed by using the status word (→ # 61).

5.4.1 Status Machine (DS402)

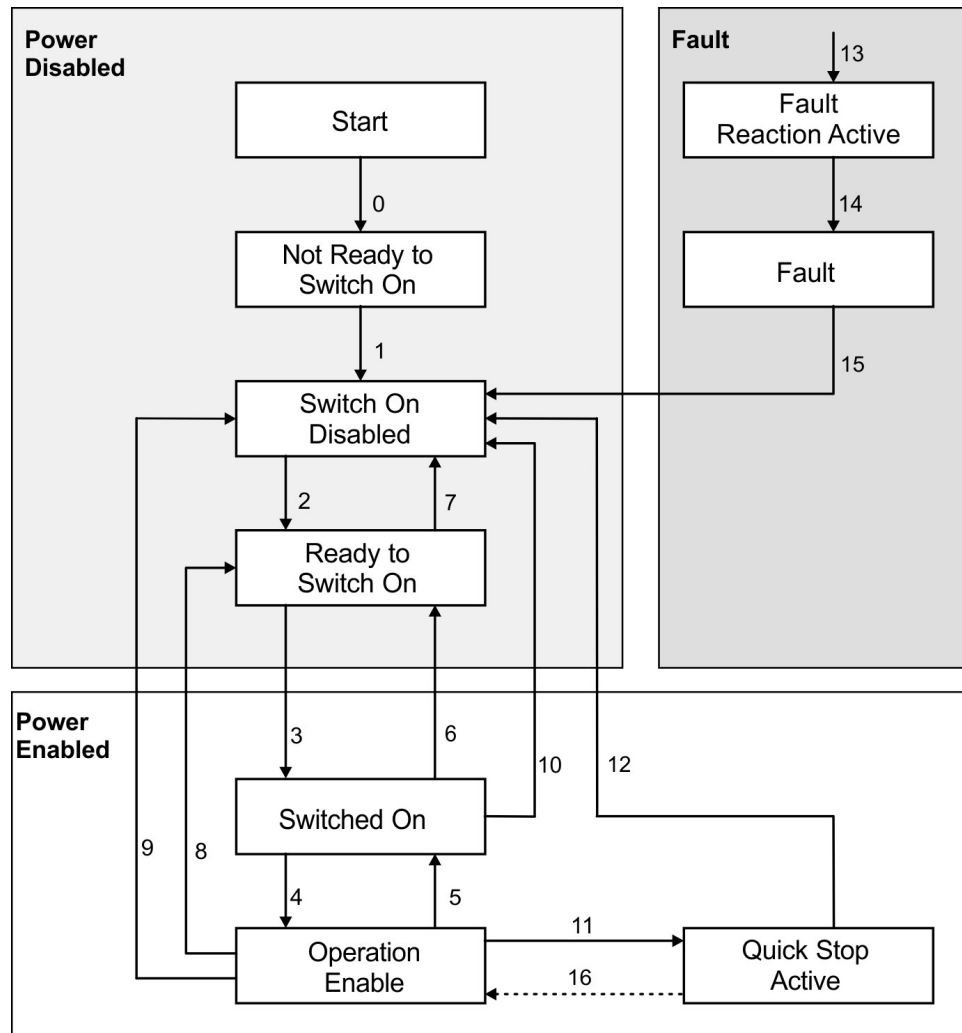

5.4.1.1 States of the Status Machine

State	Description
Not Ready for Switch On	S300/S700 is not ready to switch on, there is no operational readiness (BTB/RTO) signaled from the controller program.
Switch On Disable	S300/S700 is ready to switch on, parameters can be transferred, the DC-link voltage can be switched on, motion functions cannot be carried out yet.
Ready to Switch On	DC-link voltage may be switched on, parameters can be transferred, motion functions cannot be carried out yet.
Switched On	DC-link voltage must be switched on, parameters can be transferred, motion functions cannot be carried out yet, output stage is switched on (enabled).
Operation Enable	No fault present, output stage is enabled, motion functions are enabled.
Quick Stop Active	Drive has been stopped with the emergency ramp, output stage is enabled, motion functions are not enabled.
Fault Reaction Active	A fault has occurred and the drive is stopped with the quickstop ramp.
Fault	A fault is active, the drive has been stopped and disabled.

5.4.1.2 Transitions of the status machine

The state transitions are affected by internal events (e.g. switching off the DC-link voltage) and by the flags in the control word (bits 0,1,2,3,7).

Transition	Event	Action
0	Reset	Initialization
1	Initialization completed successfully. S300/S700 is ready to operate.	none
2	Bit 1 Disable Voltage and Bit 2 Quick Stop are set in the control word (Shutdown command). DC-link voltage may be present.	none
3	Bit 0 is also set (Switch On command)	Output stage is switched on (enabled), provided that the hardware enable is present (logical AND). Drive has torque.
4	Bit 3 is also set (Enable Operation command)	Motion function is enabled, depending on the mode that is set.
5	Bit 3 is canceled (Disable Operation command)	Motion function is inhibited. Drive is stopped, using the relevant ramp (mode-dependent). The present position is maintained.
6	Bit 0 is canceled (Shutdown command)	Output stage is disabled. Drive has no torque.
7	Bits 1 and 2 are canceled (Quick Stop / Disable Voltage command)	none
8	Bit 0 is canceled (Shutdown command)	Output stage is disabled. Drive has no torque.
9	Bit 1 is canceled (Disable Voltage command)	Output stage is disabled. Drive has no torque.
10	Bits 1 and 2 are canceled (Quick Stop / Disable Voltage command)	Output stage is disabled. Drive has no torque.
11	Bit 2 is canceled (Quick Stop command)	Drive is stopped with the emergency braking ramp. The output stage remains enabled. Setpoints are canceled. (motion block number, digital setpoint, speed for jogging or homing). Bit 2 must be set again before any further motion tasks can be performed.
12	Bit 1 is canceled ('Disable Voltage' command)	Output stage is disabled. Drive has no torque.
13	Fault reaction active	Execute appropriate fault reaction.
14	Fault reaction is completed	Drive function is disabled. The power section may be switched off.
15	"Fault Reset" command received from host	A reset of the fault condition is carried out if no fault exists currently on the drive. After leaving the state Fault the Bit7 'Reset Fault' of the controlword has to be cleared by the host.
16	Bit 2 is set	Motion function is enabled again.

NOTE

If the servo amplifier is operated through the control word / status word, then no control commands may be sent through another communication channel (RS232, CANopen, ASCII channel, Option board).

5.4.2 Object Description

5.4.2.1 Object 6040h: Control word (DS402)

The control commands are built up from the logical combination of the bits in the control word and external signals (e.g enable output stage). The definitions of the bits are shown below:

Index	6040h
Name	control word
Object code	VAR
Data type	UNSIGNED16
Access	rw
PDO mapping	possible
Unit	—
Value range	0 to 65535
EEPROM	no
Default value	0

Bit assignment in control word

Bit	Name	Bit	Name
0	Switch on	8	Pause/halt
1	Disable Voltage	9	reserved
2	Quick Stop	10	reserved
3	Enable Operation	11	reserved
4	Operation mode specific	12	reserved
5	Operation mode specific	13	Manufacturer specific
6	Operation mode specific	14	Manufacturer specific
7	Fault Reset)*	15	Manufacturer specific

)* Warnings Contouring Error (n03) and Response Monitoring Time (Nodeguarding / Heartbeat error) are reset by bit 7 (Fault Reset), too.

Commands in the control word

Command	Bit 7 Fault Reset	Bit 3 Enable Operation	Bit 2 Quick Stop	Bit 1 Disable Voltage	Bit 0 Switch on	Transitions
Shutdown	X	X	1	1	0	2, 6, 8
Switch on	X	X	1	1	1	3
Disable Voltage	X	X	X	0	X	7, 9, 10, 12
Quick Stop	X	X	0	1	X	7, 10, 11
Disable Operation	X	0	1	1	1	5
Enable Operation	X	1	1	1	1	4, 16
Fault Reset	1	X	X	X	X	15

Bits marked by an X are irrelevant.

Mode-dependent bits in the control word

The following table shows the mode-dependent bits in the control word. Only manufacturer-specific modes are supported at present. The individual modes are set by Object 6060h Modes of operation.

Operation mode	No.	Bit 4	Bit 5	Bit 6
Position	88h	reserved	reserved	reserved
Digital speed	80h	reserved	reserved	reserved
Digital current	82h	reserved	reserved	reserved
Analog speed	81h	reserved	reserved	reserved
Analog current	83h	reserved	reserved	reserved
Profile Position Mode (pp)	01h	new_set_point	change_set_immediately	absolute / relative
Profile Velocity Mode (pv)	03h	reserved	reserved	reserved
Profile Torque Mode (tq)	04h	reserved	reserved	reserved
Homing Mode (hm)	06h	homing_operation_start	reserved	reserved
Interpolated Position Mode (ip)	07h		reserved	reserved

Description of the remaining bits in the control word

The remaining bits in the control word are described below.

Bit 8 Pause If Bit 8 is set, then the drive halts (pauses) in all modes. The setpoints (speed for homing or jogging, motion task number, setpoints for digital mode) for the individual modes are retained.

Bit 9,10 These bits are reserved for the drive profile (DS402).

Bit 13, 14, 15 These bits are manufacturer-specific, and reserved at present.

5.4.2.2 Object 6041h: Status word (DS402)

The current state of the state machine can be read out with the aid of the status word.

Index	6041h
Name	Status word
Object code	VAR
Data type	UNSIGNED16
Access	rw
PDO mapping	possible
Unit	—
Value range	0 to 65535
EEPROM	yes
Default value	0

Bit assignment in the status word

Bit	Name	Bit	Name
0	Ready to switch on	8	Manufacturer specific (reserved)
1	Switched on	9	Remote (always 1)
2	Operation enabled	10	Target reached
3	Fault	11	Internal limit active
4	Voltage enabled	12	Operation mode specific (reserved)
5	Quick stop	13	Operation mode specific (reserved)
6	Switch on disabled	14	Manufacturer specific (reserved)
7	Warning	15	Manufacturer specific (reserved)

States of the state machine

State	Bit 6 switch on disabled	Bit 5 quick stop	Bit 3 fault	Bit 2 operation enabled	Bit 1 switched on	Bit 0 ready to switch on
Not ready to switch on	1	X	0	0	0	0
Switch on disabled	1	X	0	0	0	0
Ready to switch on	0	1	0	0	0	1
Switched on	0	1	0	0	1	1
Operation enabled	0	1	0	1	1	1
Fault	0	X	1	0	0	0
Fault reaction active	0	X	1	1	1	1
Quick stop active	0	0	0	1	1	1

Bits marked by X are irrelevant

Description of the remaining bits in the status word

Bit 4: voltage_enabled: The DC-link voltage is present if this bit is set.

Bit 7: warning: There are several possible reasons for Bit 7 being set and this warning being produced. The reason for this warning can be revealed by using the Object 20subindex manufacturer warnings.

Bit 9: remote: is always set to 1, i.e. the drive can always communicate and be influenced via the RS232 - interface.

Bit 10: target_reached: This is set when the drive has reached the target position.

Bit 11: internal_limit_active: This bit specifies that a movement was or is limited. In different modes, different warnings cause the bit to be set. The following assignments exist:

Mode of operation	Warnings which set Bit 11
all	n04, n06, n07, n10, n11, n14
0x1 (PP), 0x88	n03, n08, n09, n20

5.4.2.3 Object 6060h: Modes of Operation (DS402)

This object is used to set the mode, which can be read out by Object 6061h. Two types of operating mode are used:

- **manufacturer-specific operating modes.**
These modes of operation have been optimized to the functionality of the equipment.
- **operating modes as per CANopen drive profile DS402**
These operating modes are defined in the CANopen drive profile DS402.

After the mode has been changed, the corresponding setpoint must be set once more (for instance, the homing velocity in the mode homing_setpoint). If the position or jogging mode is stored, then the Homing mode is set after a RESET of the servo amplifier.

NOTE

An operating mode only becomes valid when it can be read by Object 6061h.



WARNING Automatic Restart!

Risk of death or serious injury for humans working in the machine. The drive could move unexpectedly. When the drive is enabled, a mode change is only permissible at zero speed.

- Never change the mode while the motor is running!
- Set the speed setpoint to 0 before changing over.

Index	6060h
Name	mode of operation
Object code	VAR
Data type	INTEGER8
Category	mandatory
Access	rw
PDO mapping	possible
Value range	80h ... 88h, 1, 3, 4, 6, 7
Default value	—

Supported modes (negative values are manufacturer specific modes):

Value (hex)	Mode
80	Digital velocity control mode
81	Analogue velocity control mode
82	Digital current control mode
83	Analog current control mode
84	Electronic gearing
85	reserved
86	reserved
87	reserved
88	Motion task mode
1	Profile position mode
3	Profile velocity mode
4	Profile torque mode
6	Homing mode
7	Interpolated position mode

5.4.2.4 Object 6061h: Modes of Operation Display (DS402)

This object can be used to read the mode that is set by Object 6060h. An operating mode only becomes valid when it can be read by Object 6061h (see also Object 6060h).

Index	6061h
Name	mode of operation display
Object code	VAR
Data type	INTEGER8
Category	mandatory
Access	ro
PDO mapping	possible
Value range	80h ... 88h, 1, 3, 4, 6, 7
Default value	—

5.5 Factor Groups (fg) (DS402)

The "factor groups" define the units of position-, velocity- and acceleration setpoints. These values are converted into drive-specific parameters.

NOTE

Actually the units definitions are not finally defined in the CANopen profile DS402. Therefore the Objects 6089h to 609Eh should not be used.

The drive parameters for the unit definitions should be set as follows:

PUNIT= 0 (counts)
 VUNIT= 0 (counts / s)
 ACCUNIT= 3 (counts / s²)

5.5.1 General Information

5.5.1.1 Factors

There is a possibility to convert between physical dimensions and sizes, and the internal units used in the device (increments). Several factors can be implemented. This chapter describes how these factors influence the system, how they are calculated and which data are necessary to build them.

5.5.1.2 Relationship between Physical and Internal Units

The factors defined in the factor group set up a relationship between device-internal units (increments) and physical units.

The factors are the result of the calculation of two parameters called dimension index and notation index. The dimension index indicates the physical dimension, the notation index indicates the physical unit and a decimal exponent for the values. These factors are directly used to normalize the physical values.

The notation index can be used in two ways:

- For a unit with decimal scaling and notation index < 64, the notation index defines the exponent/decimal place of the unit.
- For a unit with non-decimal scaling and notation index > 64, the notation index defines the subindex of the physical dimension of the unit.

5.5.2 Objects for position calculation

5.5.2.1 Object 6089h: position notation index (DS402)

Index	6089h
Name	position notation index
Object code	VAR
Data type	INTEGER8
Category	mandatory
Access	rw
PDO mapping	not possible
Value range	INTEGER8
Default value	0

The "position notation index" scales position setpoints, which units are defined with the "position dimension index" in SI-units, in powers of ten.

Relationship between the values for Object 6089 and the manufacturer specific parameter PUNIT:

Value of Object 6089h	ASCII parameter PUNIT	Scaling
FFh	1	10 ⁻¹
FEh	2	10 ⁻²
FDh	3	10 ⁻³
FCh	4	10 ⁻⁴
FBh	5	10 ⁻⁵
FAh	6	10 ⁻⁶
F9h	7	10 ⁻⁷
F8h	8	10 ⁻⁸
F7h	9	10 ⁻⁹
0	0	1

5.5.2.2 Object 608Ah: Position Dimension Index (DS402)

Index	608Ah
Name	position dimension index
Object code	VAR
Data type	UNSIGNED8
Category	mandatory
Access	rw
PDO mapping	not possible
Value range	UNSIGNED8
Default value	0

The "position dimension index" defines the SI-units of the used position setpoints. Relationship between the object values and the manufacturer specific parameter PUNIT:

Value of Object 608Ah	ASCII parameter PUNIT	SI unit
1	9...1	m
0	0	Manufacturer specific increments

The parameter PUNIT can be stored in the drive. The values of Object 6089h and 608Ah are initialized by that parameter.

5.5.2.3 Object 608Fh: Position encoder resolution (DS402)

The position encoder resolution defines the ratio of encoder increments per motor revolution. This object is used in the same way for Object 6090 (velocity encoder resolution).

position encoder resolution = encoder increments / motor revolutions

Index	608Fh
Name	Position encoder resolution
Object Code	ARRAY
Data Type	UNSIGNED 32
Category	optional
Subindex	0
Name	number of entries
Data type	UNSIGNED8
Category	mandatory
Access	ro
PDO Mapping	not possible
Value Range	2
Default Value	2
Subindex	1
Name	Encoder increments
Category	mandatory
Access	rw
PDO Mapping	possible
Value Range	UNSIGNED 32
Default Value	2 ²⁰
Subindex	2
Name	Motor revolutions
Category	mandatory
Access	rw
PDO Mapping	possible
Value Range	UNSIGNED 32
Default Value	1

5.5.2.4 Object 6091h: Gear Ratio (DS402)

The gear ratio defines the ratio of motor shaft revolution per driving shaft revolutions. This includes the gear if present.

gear ratio = motor shaft revolutions / driving shaft revolutions

Index	6091h
Name	Gear Ratio
Object Code	ARRAY
Data Type	UNSIGNED 32
Category	optional
Subindex	0
Name	number of entries
Data type	UNSIGNED8
Category	mandatory
Access	ro
PDO Mapping	not possible
Value Range	2
Default Value	2
Subindex	1
Name	Motor revolution
Category	mandatory
Access	rw
PDO Mapping	possible
Value Range	UNSIGNED 32
Default Value	1
Subindex	2
Name	Shaft revolutions
Category	mandatory
Access	rw
PDO Mapping	possible
Value Range	UNSIGNED 32
Default Value	1

5.5.2.5 Object 6092h: Feed constant (DS402)

The feed constant defines the ratio of feed in position units per driving shaft revolutions. This includes the gear if present.

feed constant = feed / driving shaft revolutions

Index	6092h
Name	Feed constant
Object Code	ARRAY
Data Type	UNSIGNED 32
Category	optional
Subindex	0
Name	number of entries
Data type	UNSIGNED8
Category	mandatory
Access	ro
PDO Mapping	not possible
Value Range	2
Default Value	2
Subindex	1
Name	Feed
Category	mandatory
Access	rw
PDO Mapping	possible
Value Range	UNSIGNED 32
Default Value	1
Subindex	2
Name	Shaft revolutions
Category	mandatory
Access	rw
PDO Mapping	possible
Value Range	UNSIGNED 32
Default Value	1

5.5.2.6 Object 6093h: Position factor (DS402)

The position factor converts the desired position (in position units) into the internal format (in increments). These values are calculated via the Objects 608F and 6091.

position factor = (position encoder resolution * gear ratio) / feed constant

Index	6093h
Name	Position factor
Object Code	ARRAY
Data Type	UNSIGNED 32
Category	optional
Subindex	0
Name	number of entries
Data type	UNSIGNED8
Category	mandatory
Access	ro
PDO Mapping	not possible
Value Range	2
Default Value	2
Subindex	1
Name	Numerator (position encoder resolution * gear ratio)
Category	mandatory
Access	rw
PDO Mapping	possible
Value Range	UNSIGNED 32
Default Value	1
Subindex	2
Name	Feed constant
Category	mandatory
Access	rw
PDO Mapping	possible
Value Range	UNSIGNED 32
Default Value	1

5.5.2.7 Object 6094h: Velocity encoder factor (DS402)

Object 6094 is supported as read-only object just for compatibility reasons. It converts the velocity to the internal S300/S700 data format (increments).
Scaling according to object 6093 subindices 1 and 2.

Index	6094h
Name	velocity_encoder_factor
Object Code	ARRAY
Data Type	UNSIGNED32
Category	optional
Subindex	0
Name	Anzahl der Einträge
Data type	UNSIGNED8
Category	mandatory
Access	ro
PDO Mapping	not possible
Value Range	2
Default Value	2
Subindex	1
Name	numerator
Category	mandatory
Access	ro
PDO Mapping	not possible
Value Range	0..(2 ³² -1)
Default Value	0
Subindex	2
Name	divisor
Category	mandatory
Access	ro
PDO Mapping	not possible
Value Range	0..(2 ³² -1)
Default Value	0

5.5.3 Objects for velocity calculations

5.5.3.1 Object 608Bh: velocity notation index (DS402)

Index	608Bh
Name	velocity notation index
Object code	VAR
Data type	INTEGER8
Category	mandatory
Access	rw
PDO mapping	not possible
Value range	INTEGER8
Default value	0

The "velocity notation index" scales velocity setpoints, which units are defined with the "velocity dimension index" as SI-units, in powers of ten.

Relationship between the Object-values and the parameter VUNIT:

Value of Object 608Bh	ASCII parameter VUNIT	Scaling
0	0	1
0	1	1
0	5	1
0	6	1
FDh	7	10-3
FDh	8	10-3

5.5.3.2 Object 608Ch: velocity dimension index (DS402)

Index	608Ch
Name	velocity dimension index
Object code	VAR
Data type	UNSIGNED8
Category	mandatory
Access	rw
PDO mapping	not possible
Value range	UNSIGNED8
Default value	0

The "velocity dimension index" defines the SI-unit of the used velocity setpoints. Relationship between the Object-values and the manufacturer-specific parameter VUNIT:

Value of Object 608Ch	ASCII parameter VUNIT	SI unit
A6h	0	m/s
A4h	1	turn/min
A6h	5	m/s
A7h	6	m/min
A6h	7	m/s
A7h	8	m/min

The parameter VUNIT can be stored in the drive. The values for Objects 608Bh and 608Ch are initialized by this parameter. Only the described values for VUNIT are possible with the profile DS402.

5.5.4 Objects for acceleration calculations

5.5.4.1 Object 608Dh: acceleration notation index (DS402)

Index	608Dh
Name	acceleration notation index
Object code	VAR
Data type	INTEGER8
Category	mandatory
Access	rw
PDO mapping	not possible
Value range	INTEGER8
Default value	0

The "acceleration notation index" scales acceleration setpoints, which units are defined with the "acceleration dimension index" as SI-units, in powers of ten.

Relationship between the Object-values and the parameter ACCUNIT:

Value of Object 608Dh	ASCII parameter ACCUNIT	Scaling
0	1,5	1
FAh	3	10 ⁻⁶
FDh	4	10 ⁻³

5.5.4.2 Object 608Eh: acceleration dimension index (DS402)

Index	608Eh
Name	acceleration dimension index
Object code	VAR
Data type	UNSIGNED8
Category	mandatory
Access	rw
PDO mapping	not possible
Value range	UNSIGNED8
Default value	AEh

The "acceleration dimension index" defines the SI-unit of the used acceleration setpoints. Relationship between the Object-values and the manufacturer-specific parameter ACCUNIT:

Value of Object 608Eh	ASCII parameter ACCUNIT	SI unit
AEh	1	rad/s ²
55h	3, 4, 5	m/s

The parameter ACCUNIT can be stored in the drive. The values for Objects 608Dh and 608Eh are initialized by this parameter. Only the described values for ACCUNIT are possible with the profile DS 402.

5.5.4.3 Object 6097h: Acceleration factor (DS402)

The acceleration factor converts the acceleration (in acceleration units / s) into the internal format (in increments / s). This factor is actually calculated from Object 6093 and readable only.

$$\text{acceleration factor} = (\text{velocity unit} * \text{velocity encoder factor}) / (\text{acceleration unit} * \text{second})$$

Index	6097h
Name	Acceleration factor
Object Code	ARRAY
Data Type	UNSIGNED 32
Category	optional
Subindex	0
Name	number of entries
Data type	UNSIGNED8
Category	mandatory
Access	ro
PDO Mapping	not possible
Value Range	2
Default Value	2
Subindex	1
Name	Numerator (velocity unit * velocity encoder factor)
Category	mandatory
Access	ro
PDO Mapping	possible
Value Range	UNSIGNED 32
Default Value	1
Subindex	2
Name	Divisor (acceleration unit * second)
Category	mandatory
Access	ro
PDO Mapping	possible
Value Range	UNSIGNED 32
Default Value	1

5.6 Profile Velocity Mode (pv) (DS402)

5.6.1 General Information

The profile velocity mode enables the processing of velocity setpoints and the associated accelerations.

5.6.2 Objects that are defined in this section

Index	Object	Name	Type	Access
606Ch	VAR	velocity actual value	INTEGER32	r
60FFh	VAR	target velocity	INTEGER32	rw

5.6.3 Objects that are defined in other sections

Index	Object	Name	Type	Section
6040h	VAR	control word	INTEGER16	dc (→ # 59)
6041h	VAR	status word	UNSIGNED16	dc (→ # 61)
6063h	VAR	position actual value*	INTEGER32	pc (→ # 75)
6083h	VAR	profile acceleration	UNSIGNED32	pp (→ # 89)
6084h	VAR	profile deceleration	UNSIGNED32	pp (→ # 89)
6086h	VAR	motion profile type	INTEGER16	pp (→ # 90)
6094h	ARRAY	velocity encoder factor	UNSIGNED32	fg (→ # 69)

5.6.4 Object Description

5.6.4.1 Object 606Ch: Velocity actual value (DS402)

The object velocity actual value represents the actual speed. The scaling of the value depends on the factor velocity encoder resolution (Object 6094h).

Index	606Ch
Name	velocity actual value
Object code	VAR
Data type	INTEGER32
Mode	pv
Access	ro
PDO mapping	possible
Unit	velocity units
Value range	(-2^{31}) to $(2^{31}-1)$
Default value	—
EEPROM	no

5.6.4.2 Object 60FFh: Target velocity (DS402)

The speed setpoint (target velocity) represents the setpoint for the ramp generator. The scaling of this value depends on the factor velocity encoder resolution (Object 6094h).

Index	60FFh
Name	target velocity
Object code	VAR
Data type	INTEGER32
Mode	pv
Access	rw
PDO mapping	possible
Unit	increments
Value range	(-2^{31}) to $(2^{31}-1)$
Default value	—
EEPROM	no

5.7 Profile Torque Mode (tq) (DS402)

5.7.1 General Information

The profile torque mode enables the processing of torque setpoints and the associated current.

5.7.2 Objects that are defined in this section

Index	Object	Name	Type	Access
6071h	VAR	Target torque	INTEGER16	rw
6073h	VAR	Max current	UNSIGNED16	rw
6077h	VAR	Torque actual value	INTEGER16	ro

5.7.3 Object Description

5.7.3.1 Object 6071h: Target torque (DS402)

This parameter is the input value for the torque controller in profile torque mode and the value is given per thousand of rated torque.

Index	6071h
Name	Target torque
Object code	VAR
Data type	INTEGER16
Category	conditional; mandatory, if tq supported
Access	rw
PDO mapping	possible
Value range	INTEGER16
Default value	0

5.7.3.2 Object 6073h: Max current (DS402)

This value represents the maximum permissible torque creating current in the motor and is given per thousand of rated current.

Index	6073h
Name	Max current
Object code	VAR
Data type	UNSIGNED16
Category	optional
Access	rw
PDO mapping	possible
Value range	UNSIGNED16
Default value	0

5.7.3.3 Object 6077h: Torque actual value (DS402)

The torque actual value corresponds to the instantaneous torque in the drive motor. The value is given per thousand of rated torque.

Index	6077h
Name	Torque actual value
Object code	VAR
Data type	INTEGER16
Category	optional
Access	ro
PDO mapping	possible
Value range	INTEGER16
Default value	0

5.8 Position Control Function (pc) (DS402)

5.8.1 General Information

This section describes the actual position values that are associated with the position controller of the drive. They are used for the profile position mode.

5.8.2 Objects that are defined in this section

Index	Object	Name	Type	Access
6063h	VAR	position actual value*	INTEGER32	r
6064h	VAR	position actual value	INTEGER32	r
6065h	VAR	following error window	UNSIGNED32	rw
6067h	VAR	position window	UNSIGNED32	rw
6068h	VAR	position window time	UNSIGNED16	rw

5.8.3 Objects that are defined in other sections

Index	Object	Name	Type	Section
607Ah	VAR	target position	INTEGER32	pp (→ # 87)
607Ch	VAR	home-offset	INTEGER32	hm (→ # 83)
607Dh	ARRAY	software position limit	INTEGER32	pp (→ # 87)
607Fh	VAR	max. profile velocity	UNSIGNED32	pp (→ # 88)
6093h	VAR	position factor	UNSIGNED32	fg (→ # 68)
6094h	ARRAY	velocity encoder factor	UNSIGNED32	fg (→ # 69)
6040h	VAR	control word	INTEGER16	dc (→ # 59)
6041h	VAR	status word	UNSIGNED16	dc (→ # 61)

5.8.4 Object Description

5.8.4.1 Object 6063h: position actual value* (DS402)

The object position actual value provides the momentary actual position in increments.

The resolution is defined with Object 608F as power-of-two number (see PRBASE command).

Index	6063h
Name	position actual value
Object code	VAR
Data type	INTEGER32
Mode	pc, pp
Access	rw
PDO mapping	possible
Unit	increments (1 turn = 2^{PRBASE})
Value range	(-2^{31}) to $(2^{31}-1)$
Default value	2^{20}
EEPROM	no

5.8.4.2 Object 6064h: position actual value (DS402)

The object position actual value provides the actual position. The resolution can be altered by the gearing factors of the position controller (Object 6092).

Index	6064h
Name	position actual value
Object code	VAR
Data type	INTEGER32
Mode	pc, pp
Access	rw
PDO mapping	possible
Unit	position units
Value range	(-2^{31}) to $(2^{31}-1)$
Default value	—
EEPROM	no

5.8.4.3 Object 6065h: Following error window

The following error window defines a range of tolerated position values symmetrically to the position demand value. A following error might occur when a drive is blocked, unreachable profile velocity occurs, or at wrong closed loop coefficients. If the value of the following error window is 0, the following control is switched off.

Index	6065h
Name	Following error window
Object code	VAR
Data type	UNSIGNED32
Category	optional
Access	rw
PDO mapping	possible
Value range	UNSIGNED32
Default value	1/4 of a motor revolution

5.8.4.4 Object 6067h: Position window (DS402)

The position window defines a symmetrical range of accepted positions relatively to the target position. If the actual value of the position encoder is within the position window, this target position is regarded as reached. The status word bit "Target reached" goes to 1.

Index	6067h
Name	Position window
Object code	VAR
Data type	UNSIGNED32
Category	optional
Access	rw
PDO mapping	possible
Value range	UNSIGNED32
Default value	4000 position units

5.8.4.5 Object 6068h: Position window time (DS402)

When the actual position is within the position window during the defined position window time which is given in multiples of milliseconds, the corresponding bit 10 "target reached" in the status-word will be set to one.

Index	6068h
Name	Position window time
Object code	VAR
Data type	UNSIGNED16
Category	optional
Access	rw
PDO mapping	possible
Value range	UNSIGNED16
Default value	no

5.8.4.6 Object 60F4h: Following error actual value (DS402)

This object returns the current value of the following error in units defined by the user.

Index	60F4h
Name	Following error actual value
Object code	VAR
Data type	Integer32
Category	optional
Access	ro
PDO mapping	possible
Value range	INTEGER32
Default value	0

5.9 Interpolated Position Mode (ip) (DS402)

5.9.1 General information

The interpolated position mode is implemented in a simple, straightforward way. Single position setpoints have to be transmitted in the interpolation time period and are taken over on every defined SYNC - telegram sent. A linear interpolation is used between the setpoints.

5.9.2 Objects that are defined in this section

Index	Object	Name	Type	Access
60C0h	VAR	Interpolation sub mode select	INTEG16ER	rw
60C1h	ARRAY	Interpolation data record	INTEGER32	rw
60C2h	RECORD	Interpolation time period	Interpolation time period	rw
60C3h	ARRAY	Interpolation sync definition	UNSIGNED8	rw
60C4h	RECORD	Interpolation data configuration record	Interpolation data configuration record	rw

5.9.3 Object description

5.9.3.1 Object 60C0h: Interpolation sub mode select

In the S300/S700 the linear interpolation between position setpoints is supported. The only allowed value is 0.

Index	60C0h
Name	Interpolation sub mode select
Object code	VAR
Data type	INTEGER16
Category	optional
Access	rw
PDO mapping	possible
Value range	0
Default value	0

5.9.3.2 Object 60C1h: Interpolation data record

In the S300/S700 a single setpoint is supported for the interpolated position mode. For the linear interpolation mode each interpolation data record simply can be regarded as a new position setpoint.

After the last item of an interpolation data record is written to the devices input buffer, the pointer of the buffer is automatically incremented to the next buffer position.

Index	60C1h
Name	Interpolation data record
Object code	ARRAY
Data type	INTEGER32
Category	optional

Subindex	0
Description	number of entries
Data type	UNSIGNED8
Category	mandatory
Access	ro
PDO mapping	not possible
Value range	1
Default value	no

Subindex	1
Description	x1, the first parameter of ip function $fip(x1, \dots, xN)$
Category	mandatory
Access	rw
PDO mapping	possible
Value range	INTEGER32
Default value	no

5.9.3.3 Object 60C2h: Interpolation time period

The interpolation time period is used for the PLL (phase locked loop) synchronized position modes. The unit (subindex 1) of the time is given in $10^{\text{interpolation time index}}$ seconds.

Only multiples of 1 ms are allowed. The two values define the internal ASCII - parameter PTBASE (given in multiples of 250 Mikroseconds). Both values must be written to fix a new interpolation time period. PTBASE will only be updated then.

Index	60C2h
Name	Interpolation time period
Object code	RECORD
Data type	Interpolation time period record (0080h)
Category	optional

Subindex	0
Description	number of entries
Category	mandatory
Access	ro
PDO mapping	not possible
Value range	2
Default value	2

Subindex	1
Description	Interpolation time units
Category	mandatory
Access	rw
PDO mapping	possible
Value range	UNSIGNED8
Default value	1

Subindex	2
Description	Interpolation time index
Category	mandatory
Access	rw
PDO mapping	possible
Value range	-123 ... 63
Default value	-3

5.9.3.4 Objekt 60C3h: Interpolation sync definition

In the S300/S700 the generally used SYNC-object is used for synchronization purposes. Therefore only a fixed value is accepted for subindex 1.

Index	60C3h
Name	Interpolation sync definition
Object code	ARRAY
Data type	UNSIGNED8
Category	optional
Subindex	0
Description	number of entries
Category	mandatory
Access	ro
PDO mapping	not possible
Value range	2
Default value	1
Subindex	1
Description	Synchronize on group
Category	mandatory
Access	rw
PDO mapping	possible
Value range	UNSIGNED8
Default value	0

5.9.3.5 Object 60C4h: Interpolation data configuration

Only a single position setpoint is supported in the S300/S700. Therefore only the value 1 in Subindex 5 is possible. All other subindices are set to 0.

Index	60C4h
Name	Interpolation data configuration
Object code	RECORD
Data type	Interpolation data configuration record (0081h)
Category	optional
Subindex	0
Description	number of entries
Category	mandatory
Access	ro
PDO mapping	not possible
Value range	6
Default value	6
Subindex	1
Description	Maximum buffer size
Category	mandatory
Access	ro
PDO mapping	not possible
Value range	UNSIGNED32
Default value	0

Subindex	2
Description	Actual buffer size
Category	mandatory
Access	rw
PDO mapping	possible
Value range	UNSIGNED32
Default value	0
Subindex	3
Description	Buffer organization
Category	mandatory
Access	rw
PDO mapping	possible
Value range	UNSIGNED8
Default value	0
Subindex	4
Description	Buffer position
Category	mandatory
Access	rw
PDO mapping	possible
Value range	UNSIGNED16
Default value	0
Subindex	5
Description	Size of data record
Category	mandatory
Access	w
PDO mapping	possible
Value range	1 to 254
Default value	1
Subindex	6
Description	Buffer clear
Category	mandatory
Access	w
PDO mapping	possible
Value range	UNSIGNED8
Default value	0

5.10 Homing Mode (hm) (DS402)

5.10.1 General information

This section describes the various parameters which are required to define a homing mode.

5.10.2 Objects that are defined in this section

Index	Object	Name	Type	Access
607Ch	VAR	home offset	INTEGER32	rw
6098h	VAR	homing method	INTEGER8	rw
6099h	ARRAY	homing speeds	UNSIGNED32	rw
609Ah	VAR	homing acceleration	UNSIGNED32	rw

5.10.3 Objects that are defined in other sections

Index	Object	Name	Type	Section
6040h	VAR	control word	INTEGER16	dc (→ # 59)
6041h	VAR	status word	UNSIGNED16	dc (→ # 61)

5.10.4 Object description

5.10.4.1 Object 607Ch: Homing offset (DS402)

The reference offset (home offset) is the difference between the zero position for the application and the zero point of the machine. All subsequent absolute motion tasks take account of the reference offset.

Index	607Ch
Name	home offset
Object code	VAR
Data type	INTEGER32
Mode	hm
Access	rw
PDO mapping	possible
Unit	user-defined
Value range	(-2^{31}) to $(2^{31}-1)$
Default value	0

5.10.4.2 Object 6098h: Homing method (DS402)

Index	6098h
Name	homing method
Object code	VAR
Data type	INTEGER8
Mode	hm
Access	rw
PDO mapping	possible
Unit	position units
Value range	-128 to 127
Default value	0
EEPROM	yes

The following homing methods are supported:

Method	Brief description: Homing	ASCII command
-128..-9	reserved	—
-8	move to absolute SSI positionS	—
-7	move to mechanical stop, following error sets reference	NREF = 9, DREF = 0
-6	move to mechanical stop, following error sets reference	NREF = 9, DREF = 1
-5, -4	reserved	—
-3	move to mechanical stop, with zeroing	NREF = 7
-2	set reference point at present position, allowing for following error	NREF = 6
-1	homing within a single turn (direction depends on distance)	NREF = 5, DREF= 2
0	reserved	—
1	homing to negative limit switch, with zeroing, negative count direction	NREF = 2, DREF= 0
2	homing to positive limit switch, with zeroing, positive count direction	NREF = 2, DREF= 1
3..7	not supported	—
8	homing to reference switch, with zeroing, positive count direction	NREF = 1, DREF= 1
9..11	not supported	—
12	homing to reference switch, with zeroing, negative count direction	NREF = 1, DREF= 0
13..14	not supported	—
15..16	reserved	—
17	homing to negative limit switch, without zeroing, negative count direction	NREF = 4, DREF= 0
18	homing to negative limit switch, without zeroing, positive count direction	NREF = 4, DREF= 1
19..23	not supported	—
24	homing to reference switch, without zeroing, positive count direction	NREF = 3, DREF= 1
25..27	not supported	—
28	homing to reference switch, without zeroing, negative count direction	NREF = 3, DREF= 0
29..30	not supported	—
31..32	reserved	—
33	homing within a single turn, negative count direction	NREF = 5, DREF= 0
34	homing within a single turn, positive count direction	NREF = 5, DREF= 1
35	set reference point at present position	NREF = 0
36..127	reserved	—

Description of the homing methods

Choosing a homing method by writing a value to homing method (Object 6098h) will clearly establish:

- the homing signal (P-Stop, N-Stop, reference switch)
- the direction of actuation

and where appropriate

- the position of the index pulse.

The reference position is give by the reference offset (Object 607Ch). The manufacturer specific parameter ENCZERO (Object 3537h, Subindex 01h) can be used to adapt the initial position of the motor for homing to match the index pulse for homing with zeroing.

A detailed description of the types of homing movement can be found in the description of the setup software DriveGUI.exe.

5.10.4.3 Object 6099h: Homing speeds (DS402)

Index	6099h
Name	homing speeds
Object code	ARRAY
Data type	UNSIGNED32
Subindex	1
Description	speed during search for switch
Mode	hm
Access	rw
PDO mapping	possible
Unit	velocity units
Value range	0 to $(2^{32}-1)$
Default value	equivalent 60 rpm
EEPROM	yes
Subindex	2
Description	speed during search for zero
Mode	hm
Access	rw
PDO mapping	not possible
Unit	velocity units
Value range	0 to $(2^{32}-1)$
Default value	$1/8 * \text{Object 6099 sub 1}$
EEPROM	yes

5.10.4.4 Object 609Ah: Homing acceleration (DS402)

Index	609Ah
Name	homing acceleration
Object code	VAR
Data type	UNSIGNED32
Mode	hm
Access	rw
PDO mapping	possible
Unit	acceleration units
Value range	0 to $(2^{32}-1)$
Default value	0
EEPROM	yes

5.10.5 Homing Mode Sequence

The homing movement is started by setting Bit 4 (positive edge). The successful conclusion is indicated by Bit 12 in the status word (see Object 6041h). Bit 13 indicates that an error occurred during the homing movement. In this case, the error code must be evaluated (error register: Objects 1001h, 1003h, manufacturer status: Object1002h).

Bit 4	Meaning
0	homing inactive
0 → 1	start homing movement
1	homing active
1 → 0	interruption of homing movement

Bit 13	Bit 12	Meaning
0	0	reference point not set, or homing movement not yet finished
0	1	reference point set, homing movement finished
1	0	homing movement could not be successfully concluded (lag error)
1	1	impermissible state

5.11 Profile Position Mode (pp)

5.11.1 General Information

The overall structure for this mode is shown in this figure:

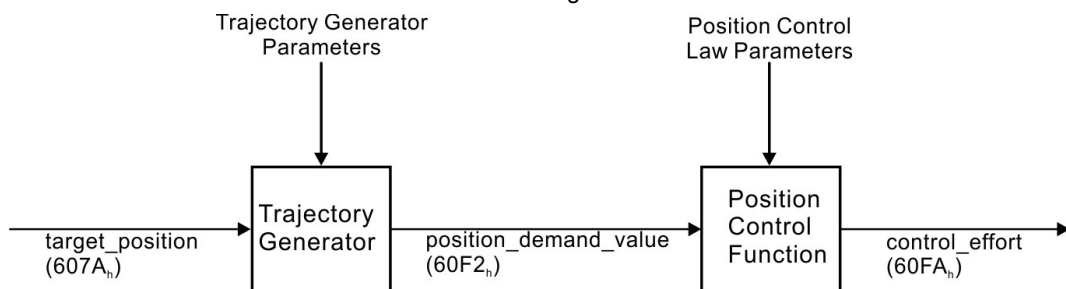

The special handshake procedure for the control word and status word see (→ # 91).

5.11.2 Objects that are defined in this section

Index	Object	Name	Type	Access
607Ah	VAR	target position	INTEGER32	rw
607Dh	ARRAY	software position limit	INTEGER32	rw
607Fh	VAR	max. profile velocity	UNSIGNED32	rw
6080h	VAR	max. motor speed	UNSIGNED32	rw
6081h	VAR	profile velocity	UNSIGNED32	rw
6083h	VAR	profile acceleration	UNSIGNED32	rw
6084h	VAR	profile deceleration	UNSIGNED32	rw
6085h	VAR	quick stop deceleration	UNSIGNED32	rw
6086h	VAR	motion profile type	INTEGER16	rw

5.11.3 Objects that are defined in other sections

Index	Object	Name	Type	Section
6040h	VAR	control word	INTEGER16	dc (→ # 59)
6041h	VAR	status word	UNSIGNED16	dc (→ # 61)
6093h	ARRAY	position factor	UNSIGNED32	fg (→ # 68)
6094h	ARRAY	velocity encoder factor	UNSIGNED32	fg (→ # 69)
6097h	ARRAY	acceleration factor	UNSIGNED32	fg (→ # 72)

5.11.4 Object description

5.11.4.1 Object 607Ah: Target position (DS402)

The object target position defines the target position for the drive. The target position is interpreted as a relative distance or an absolute position, depending on Bit 6 of the control word. The type of relative movement can be further defined by the manufacturer-specific parameter 35B9h Sub 1. The mechanical resolution is set by the gearing factors Object 6093h Subindex 1 and 2.

Index	607Ah
Name	target position
Object code	VAR
Data type	INTEGER32
Mode	pp
Access	rw
PDO mapping	possible
Unit	user-defined
Value range	$-(2^{31}-1)$ to $(2^{31}-1)$
Default value	no
EEPROM	no

5.11.4.2 Object 607Dh: Software position limit (DS402)

Software position limit contains the sub-parameters min position limit and max position limit. New effective target positions are checked against these limits. The limits are relative to the machine home position, which is build through homing including the home offset (Object 607C).

As default the software position limits are switched off. If the values are changed from these default values a special configuration is made in the drive. Therefore the new values have to be saved and the drive has to be restarted to take the software limits into action.

Index	607Dh
Name	Software position limit
Object code	ARRAY
Data type	INTEGER32
Category	optional
Subindex	0
Description	number of entries
Category	mandatory
Access	ro
PDO mapping	not possible
Value range	2
Default value	2
Subindex	1
Description	min position limit
Category	mandatory
Access	rw
PDO mapping	possible
Value range	INTEGER32
Default value	0 (switched off)
Subindex	2
Description	Min Position Limit
Category	mandatory
Access	rw
PDO mapping	possible
Value range	INTEGER32
Default value	0 (switched off)

5.11.4.3 Object 607Fh: Max profile velocity (DS402)

The maximum profile velocity is the maximum allowed speed in either direction during a profiled move. It is given in the same units as profile velocity.

Index	607Fh
Name	Max profile velocity
Object code	VAR
Data type	UNSIGNED32
Category	optional
Access	rw
PDO mapping	possible
Value range	UNSIGNED32
Default value	equivalent to the maximum motor speed (Object 6080)

5.11.4.4 Object 6080h: Max motor speed (DS402)

The max motor speed is the maximum allowable speed for the motor in either direction and is given in rpm. This is used to protect the motor and can be taken from the motor data sheet.

Index	6081h
Name	Max motor speed
Object code	VAR
Data type	UNSIGNED32
Mode	optional
Access	rw
PDO mapping	possible
Value range	UNSIGNED32
Default value	depending on motor

5.11.4.5 Object 6081h: Profile velocity (DS402)

The profile velocity is the final velocity that should be reached after the acceleration phase of a motion task. The scaling used depends on the setting of the velocity encoder factor (Object 6094h). The application of the setpoint depends on the operation mode (pp, pv) that is set.

Index	6081h
Name	profile velocity
Object code	VAR
Data type	UNSIGNED32
Mode	pp, pv
Access	rw
PDO mapping	possible
Unit	speed units
Value range	0 to $(2^{32}-1)$
Default value	10
EEPROM	no

5.11.4.6 Object 6083h: Profile acceleration (DS402)

The acceleration ramp (profile acceleration) is given in units that are defined by the user (position units per s²). They can be transformed with the acceleration factor defined by Object 6097sub1&2. The type of acceleration ramp can be selected as a linear ramp or a sin² ramp (see Object 6086h).

Index	6083h
Name	profile acceleration
Object code	VAR
Data type	UNSIGNED32
Mode	pp
Access	rw
PDO mapping	possible
Unit	acceleration units
Value range	0 to (2 ³² -1)
Default value	0

5.11.4.7 Object 6084h: Profile deceleration (DS402)

The braking/deceleration ramp is handled in the same way as the acceleration ramp (see Object 6083h).

Index	6084h
Name	profile deceleration
Object code	VAR
Data type	UNSIGNED32
Mode	pp
Access	rw
PDO mapping	possible
Unit	acceleration units
Value range	0 to (2 ³² -1)
Default value	0

5.11.4.8 Object 6085h: Quick stop deceleration

The quick stop deceleration is the deceleration used to stop the motor if the 'Quick Stop' command is given. The units are the same as for the profile acceleration ramp and the profile deceleration ramp.

Index	6085h
Name	Quick stop deceleration
Object code	VAR
Data type	UNSIGNED32
Mode	pp
Access	rw
PDO mapping	possible
Unit	acceleration units
Value range	0 to (2 ³² -1)
Default value	-

5.11.4.9 Object 6086h: Motion Profile Type (DS402)

The type of acceleration ramp can be selected by this object as a linear or as \sin^2 ramp.

Index	6086h
Name	Motion Profile Type
Object code	VAR
Data type	INTEGER16
Mode	pp
Access	rw
PDO mapping	possible
Unit	none
Value range	-2^{15} to $(2^{15}-1)$
Default value	-
EEPROM	yes

Profile Code	Profile Type
-32768 ... -1	manufacturer specific (not supported)
0	linear (trapezoidal)
1	\sin^2
Value 2 ... 32767	profile-specific extensions (not supported)

5.11.4.10 Object 60C5h: Max acceleration

To prevent the motor and the application from being destroyed, the max acceleration can be used to limit the acceleration to an acceptable value. The max acceleration is given in user defined acceleration units (608Dh, 608Eh). It is converted to position increments per s^2 using the acceleration factor (6097h).

Index	60C5h
Name	Max acceleration
Object code	VAR
Data type	UNSIGNED32
Category	Optional
Access	rw
PDO mapping	possible
Value range	UNSIGNED32
Default value	-

5.11.5 Functional Description

Two different ways to apply target positions to a drive are supported by this device profile.

Set of setpoints:

After reaching the `target_position`, the drive device immediately processes the next target position, which results in a move where the velocity of the drive normally is not reduced to zero after achieving a setpoint. With S300/S700, this is only possible if trapezoidal ramps are used.

Single setpoints:

After reaching the `target_position`, the drive device signals this status to a host computer and then receives a new setpoint. After reaching a `target_position`, the velocity is normally reduced to zero before starting a move to the next setpoint.

The two modes are controlled by the timing of the bits for `new_setpoint` and `change_set_immediately` in the control word, and `setpoint_acknowledge` in the status word. These bits allow the setting up of a request-response mechanism in order to prepare a set of setpoints while another set is still being processed in the drive unit. This minimizes reaction times within a control program on a host computer.

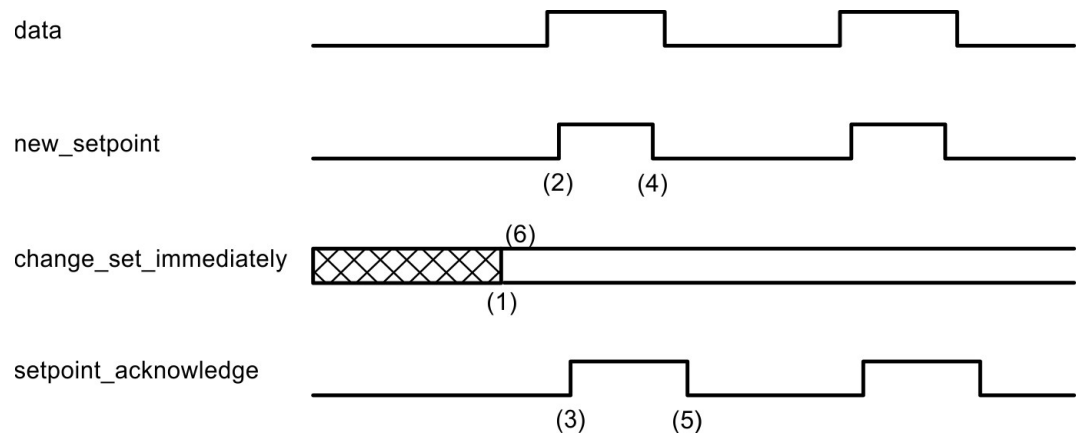

The figures show the difference between the `set_of_setpoints` mode and the `single setpoint` mode. The initial status of the bit `change_set_immediately` in the control word determines which mode is used. To keep these examples simple, only trapezoidal moves are used.

If the bit **change_set_immediately** is "0" a single setpoint is expected by the drive (1). After data is applied to the drive, a host signals that the data is valid by changing the bit **new_setpoint** to "1" in the control word (2). The drive responds with **setpoint_acknowledge** set to "1" in the status word (3) after it has recognized and buffered the new valid data. Now the host can release **new_setpoint** (4) and subsequently the drive will signal through **setpoint_acknowledge** = "0" its ability to accept new data again (5).

In the figure below this mechanism results in a velocity of zero after ramping down to reach a **target_position X1** at t_1 . After signaling to the host, that the setpoint has been reached as described above, the next **target_position** is processed at t_2 and reached at t_3 .

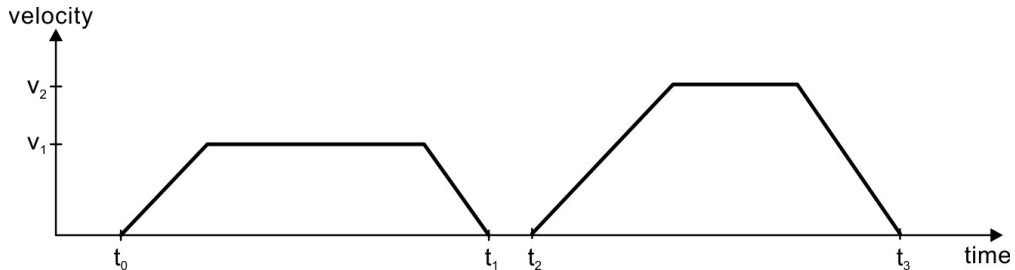

With **change_set_immediately** set to "1" (6), the host instructs the drive to apply a new setpoint immediately after reaching the previous one. The relative timing of the other signals is unchanged. This behavior causes the drive to process the next setpoint X2 in advance, and to hold its velocity when it reaches the **target_position X1** at t_1 . The drive then moves immediately to the next **target_position X2** that has already been calculated.

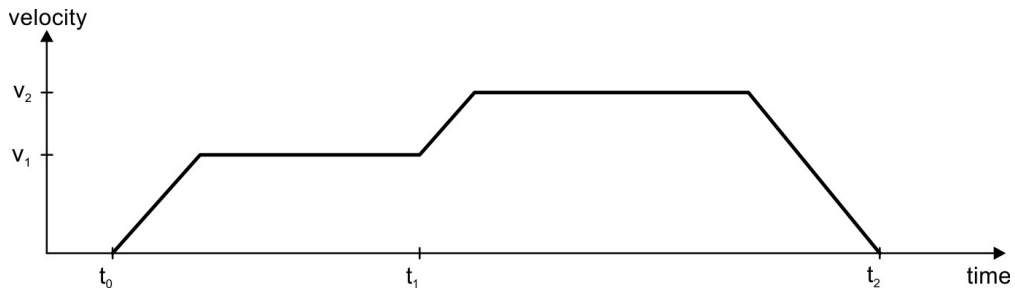

Bits in the control word:		Bits in the status word:	
Bit 4	new_set_point (positive edge!)	Bit 12	setpoint acknowledge
Bit 5	change_set_immediately	Bit 13	lag/following error
Bit 6	absolute/relative		

Notes on motion task type relative:

If Bit 6 is set, then the motion task type is relative, and activated according to the last target position or actual position. If other types of relative motion are required, these must be activated in advance through the ASCII-object O_C (Object 35B9 sub 1).

Notes on profile position mode:

Functional description for the profile position mode

The drive profile DS402 distinguishes between two methods of moving to a target position. These two methods are controlled by the bits for **new_setpoint** and **change_set_immediately** in the control word, and **setpoint_acknowledge** in the status word. These bits can be used to prepare a motion task while another is still being carried out (handshake).

- Moving to several target positions without an intermediate halt
After the target position has been reached, the drive moves immediately to the next target position. This requires that new setpoints are signaled to the drive. This is done through a positive transition of the **new_setpoint** bit. In this case, the **setpoint_acknowledge** bit must not be active (=1) in the status word (see also Handshake DS402). The velocity is not reduced to zero when the first setpoint is reached.
- Moving to a single target position
The drive moves to the target position, whereby the velocity is reduced to zero. Reaching the target position is signaled by the bit for **target_reached** in the status word.

6 Appendix

6.1 The Object Channel

6.1.1 Objects >3500h Manufacturer specific object channel

The Object Dictionary has been expanded beyond Index 3500h (reserved object range 3500h ... 3900h) for all Device Objects that can be described in up to 4 bytes of user data. This range can be dynamically extended, i.e. if extensions are made, new device parameters that fulfil the above-mentioned format are automatically added to the table for the core firmware. Object 3500h (Sub 01h, read) can be used to show the total number of objects in the Object Channel (→ # 104).

NOTE

The objects in the Object Channel (ASCII parameters) cannot be mapped in a PDO!

Index	> 3500h
Name	Object-dependent
Object code	VAR
Data type	RECORD
Subindex	0
Description	number of entries
Unit	—
Access	—
PDO mapping	not possible
Data type	UNSIGNED8
Value range	0 ... 28-1
EEPROM	—
Default value	—
Subindex	1
Description	read/write a parameter
Unit	see corresponding ASCII command
Access	see corresponding ASCII command
PDO mapping	not possible
Data type	see corresponding ASCII command, transmission always as INTEGER32
Value range	see corresponding ASCII command
EEPROM	see Subindex 4
Default value	see corresponding ASCII command
Subindex	2
Description	read lower limit value
Unit	see corresponding ASCII command
Access	ro
PDO mapping	not possible
Data type	see corresponding ASCII command
Value range	see corresponding ASCII command
EEPROM	—
Default value	—
Subindex	3
Description	read upper limit value
Unit	see corresponding ASCII command
Access	ro
PDO mapping	not possible
Data type	see corresponding ASCII command
Value range	see corresponding ASCII command
EEPROM	—
Default value	—

Subindex	4
Description	read the default value
Unit	see corresponding ASCII command
Access	ro
PDO mapping	not possible
Data type	see corresponding ASCII command
Value range	see corresponding ASCII command
EEPROM	—
Default value	—

Subindex	5
Description	read the parameter format
Unit	—
Access	ro
PDO mapping	not possible
Data type	see corresponding ASCII command
Value range	see corresponding ASCII command
EEPROM	—
Default value	—

Possible parameter formats:

0	Function (no parameter, read-only)	7	INTEGER32
1	Function (INTEGER32 parameter)	8	UNSIGNED32
2	Function (INTEGER32 parameter with weighting 3)	9	INTEGER32 (weighting 3)
3	INTEGER8	10	INTEGER32 (weighting 3)
4	UNSIGNED8	11	
5	INTEGER16	12	UNSIGNED32
6	UNSIGNED16	13	UNSIGNED16

Subindex	6
Description	read the parameter check data
Unit	—
Access	ro
PDO mapping	not possible
Data type	UNSIGNED32
Value range	0 ... $2^{32}-1$
EEPROM	—
Default value	—

Description:

0x00010000 After an alteration the variable must be saved and the controller must be reset.

0x00020000 Variable is saved in the serial EEPROM.

0x00200000 Variable is read-only, must not be written to over the bus.

Subindex	7 / 8
Description	reserved
Unit	—
Access	ro
PDO mapping	not possible
Data type	UNSIGNED32
Value range	0 ... $2^{32}-1$
EEPROM	—
Default value	—

6.1.2 ASCII command reference

MLC=multi-line return command, ro=read only, rw=read/write

CAN Object number	ASCII Command	ASCII Type	Description
3501 (hex)	ACC	Variable rw	Acceleration Ramp
3502 (hex)	ACCR	Variable rw	Acceleration Ramp for homing/jog modes
3503 (hex)	ACTFAULT	Variable rw	Active Fault Mode
3504 (hex)	ACTIVE	Variable ro	Output stage active/inhibited
3505 (hex)	ADDR	Variable ro	Multidrop Address
3506 (hex)	AENA	Variable rw	Software Auto-Enable
3507 (hex)	ANCNFG	Variable rw	Configuration of Analog Input
3508 (hex)	ANDB	Variable rw	Dead Band of the Analog Velocity Input Signal
3509 (hex)	ANIN1	Variable ro	Voltage at Analog Input 1
350A (hex)	ANIN2	Variable ro	Voltage at Analog Input 2
350B (hex)	ANOFF1	Variable rw	Analog Offset for analog input 1
350C (hex)	ANOFF2	Variable rw	Analog Offset for analog input 2
350F (hex)	ANZERO1	Command	Zero Analog Input 1
3510 (hex)	ANZERO2	Command	Zero Analog Input SW2
3511 (hex)	AVZ1	Variable rw	Filter Time Constant for analog input 1
3512 (hex)	CALCHP	Command	Determining the Hiperface Parameters
3513 (hex)	CALCRK	Command	Calculate resolver parameters
3514 (hex)	CALCRP	Command	Calculate resolver phase
3515 (hex)	CBAUD	Variable rw	Baud Rate CAN Bus
3518 (hex)	CLRFault	Command	Clear Drive Fault
3519 (hex)	CLRHR	Command	Bit 5 of status register STAT is cleared
351A (hex)	CLRORDER	Command	Deleting a Motion Task
351B (hex)	CLRWARN	Variable rw	Warning mode
351D (hex)	CONTINUE	Command	Continue last position order
351E (hex)	CTUNE	Command	Calculate current parameters
351F (hex)	CUPDATE	Command	Program Update (CAN Bus)
3522 (hex)	DEC	Variable rw	Deceleration Rate
3523 (hex)	DECDIS	Variable rw	Deceleration used on Disable Output Stage
3524 (hex)	DECR	Variable rw	Deceleration Ramp for homing/jog modes
3525 (hex)	DECSTOP	Variable rw	Quick Stop, braking ramp for emergency stop
3527 (hex)	DICONT	Variable ro	Drive Continuous Current
3528 (hex)	DIFVAR	MLC	List Variables with Values
3529 (hex)	DIPEAK	Variable ro	Drive Peak Rated Current
352B (hex)	DIS	Command	Software-Disable
352C (hex)	DREF	Variable rw	Direction for Homing
352D (hex)	DRVSTAT	Variable ro	internal Status information
352E (hex)	DR_TYPE	Variable ro	Gives the Output Stage Identification
352F (hex)	DUMP	MLC	List All EEPROM Variables with Values
3530 (hex)	EN	Command	Software-Enable
3533 (hex)	ENCLINES	Variable rw	SinCos Encoder Resolution
3534 (hex)	ENCMODE	Variable rw	Selection of Encoder Emulation
3535 (hex)	ENCOUT	Variable rw	Resolution Encoder Emulation EEO (ROD)
3537 (hex)	ENCZERO	Variable rw	Zero Pulse Offset EEO (ROD)
3538 (hex)	EXTMUL	Variable rw	ext. Encoder multiplier
3539 (hex)	EXTPOS	Variable rw	Position Value For Position Control
353A (hex)	EXTWD	Variable rw	External Watch Dog (Fieldbus)
353B (hex)	FBTYPE	Variable rw	Selection of commutation feedback
353C (hex)	FILTMODE	Variable rw	Smith Predictor
353E (hex)	GEARI	Variable rw	Input Factor for Electronic Gearing
353F (hex)	GEARMODE	Variable rw	Position Input Electronic Gearing Mode
3540 (hex)	GEARO	Variable rw	Output Factor for Electronic Gearing

CAN Object number	ASCII Command	ASCII Type	Description
3541 (hex)	GET	Command	Scope: output data
3542 (hex)	GP	Variable rw	Position Control Loop: Proportional Gain
3545 (hex)	GPFFV	Variable rw	Position Control Loop: Feed Forward for Velocity
3548 (hex)	GV	Variable rw	Velocity Control Loop: Proportional Gain
354B (hex)	GVFR	Variable rw	PI-PLUS Actual Velocity Feedforward
354D (hex)	GVTN	Variable rw	Velocity Control Loop: I-Integration Time
3551 (hex)	HDUMP	MLC	Output all sin/cos (Hiperface) variables
3552 (hex)	HICOFFS	Variable rw	Hiperface: Cosine-Offset (incremental track)
3553 (hex)	HIFACT1	Variable rw	Hiperface: Sin/Cos Gain Factor (incremental track)
3554 (hex)	HISOFFS	Variable rw	Hiperface: Sin/Cos Offset (incremental track)
3556 (hex)	HSAVE	Command	Hiperface: Save Parameters in Encoder
3557 (hex)	HVER	Variable ro	Output the Hardware Version
3558 (hex)	I	Variable ro	Current Monitor
355A (hex)	I2TLIM	Variable rw	I2T Warning
355B (hex)	ICMD	Variable ro	Current Setpoint
355D (hex)	ID	Variable ro	D-component of Current Monitor
355E (hex)	IDUMP	MLC	Output Current Limit List
3560 (hex)	IN	MLC	List Analog Voltage Values
3561 (hex)	IN1	Variable ro	Status of Digital Input 1
3561 (hex)	IN5_20	Variable ro	Status of digital inputs 5 ...20
3562 (hex)	IN1MODE	Variable rw	Function of Digital Input 1
3562 (hex)	IN5_20MODE	Variable rw	Function of digital inputs 5 ...20
3563 (hex)	IN1TRIG	Variable rw	Variable for IN1MODE
3563 (hex)	IN5_20TRIG	Variable rw	Variable for digital inputs 5 ...20
3564 (hex)	IN2	Variable ro	Status of Digital Input 2
3565 (hex)	IN2MODE	Variable rw	Function of Digital Input 2
3566 (hex)	IN2TRIG	Variable rw	Variable for IN2MODE
3567 (hex)	IN3	Variable ro	Status of Digital Input 3
3568 (hex)	IN3MODE	Variable rw	Function of Digital Input 3
3569 (hex)	IN3TRIG	Variable rw	Variable for IN3MODE
356A (hex)	IN4	Variable ro	Status of Digital Input 4.
356B (hex)	IN4MODE	Variable rw	Function of Digital Input 4
356C (hex)	IN4TRIG	Variable rw	Variable for IN4MODE
356D (hex)	INPOS	Variable ro	Status of In-Position Signal
356E (hex)	IPEAK	Variable rw	Application Peak Current
3570 (hex)	IQ	Variable ro	Q-Component of Current Monitor
3571 (hex)	ISCALE1	Variable rw	Scaling of Analog Current Setpoint 1
3572 (hex)	ISCALE2	Variable rw	Scaling of Analog Current Setpoint 2
3573 (hex)	K	Command	Kill (=Disable)
3574 (hex)	KC	Variable rw	I-Controller Prediction Constant
3575 (hex)	KEYLOCK	Variable rw	Locks the push buttons
3577 (hex)	ML	Variable rw	Stator Inductance of the Motor
3578 (hex)	LATCH2P16	Variable rw	Latched 16-bit Position (positive edge)
3579 (hex)	LATCH2N16	Variable rw	Latched 16-bit Position (negative edge)
357A (hex)	LATCH2P32	Variable rw	Latched 32-bit Position (positive edge)
357B (hex)	LATCH2N32	Variable rw	Latched 32-bit Position (negative edge)
357C (hex)	LATCH1P32	Variable rw	Latched 32-bit Position (positive edge)
357D (hex)	LATCH1N32	Variable rw	Latched 32-bit Position (negative edge)
357E (hex)	LED1	Variable rw	State of Display 1 Segment
357F (hex)	LED2	Variable rw	State of Display 2 Segment
3580 (hex)	LED3	Variable rw	State of Display 3 Segment
3581 (hex)	LEDSTAT	Variable rw	Display page
3582 (hex)	LIST	MLC	List All ASCII Commands
3583 (hex)	LOAD	Command	Load parameters from serial EEPROM

CAN Object number	ASCII Command	ASCII Type	Description
3584 (hex)	MAXTEMPE	Variable rw	Ambient Temperature Switch off Threshold
3585 (hex)	MAXTEMPH	Variable rw	Heat Sink Temperature Switch off Threshold
3586 (hex)	MAXTEMPM	Variable rw	Motor Temperature Switch off Threshold
3587 (hex)	MBRAKE	Variable rw	Select Motor Holding Brake
3588 (hex)	MDBCNT	Variable ro	Number of Motor Data Sets
3589 (hex)	MDBGET	Command	Get Actual Motor Data Set
358A (hex)	MDBSET	Command	Set Actual Motor Data Set
358C (hex)	VLIM	Variable rw	Max. Velocity
358D (hex)	MH	Command	Start Homing
358E (hex)	MICONT	Variable rw	Motor Continuous Current Rating
358F (hex)	MIPEAK	Variable rw	Motor Peak Current Rating
3591 (hex)	MJOG	Command	Start Jog Mode
3592 (hex)	MVANGLP	Variable rw	Velocity-dependent Lead (Commutation Angle)
3593 (hex)	MKT	Variable rw	Motor KT
3595 (hex)	MLGC	Variable rw	Current Control loop Adaptive Gain, Q-component at rated current
3596 (hex)	MLGD	Variable rw	Adaptive Gain for Current Control loop, D-component
3597 (hex)	MLGP	Variable rw	Current Control loop Adaptive Gain, Q-component at peak current
3598 (hex)	MLGQ	Variable rw	Absolute Gain of Current Control loop
3599 (hex)	MNUMBER	Variable rw	Motor Number
359C (hex)	MPHASE	Variable rw	Motor Phase, Feedback Offset
359D (hex)	MPOLES	Variable rw	Number of Motor Poles
35A0 (hex)	MRESBW	Variable rw	Resolver Bandwidth
35A1 (hex)	MRESPOLES	Variable rw	Number of Resolver Poles (Multispeed)
35A2 (hex)	MSG	Variable rw	Enable / Disable All Messages via RS232
35A3 (hex)	MSPEED	Variable rw	Maximum Rated Motor Velocity
35A5 (hex)	MTANGLP	Variable rw	Current Lead
35A6 (hex)	MTYPE	Variable rw	Motor Type
35A7 (hex)	MVANGLB	Variable rw	Velocity-dependent Lead (Start Phi)
35A8 (hex)	MVANGLF	Variable rw	Velocity-dependent Lead (Limit Phi)
35A9 (hex)	M_RESET	Command	Recompile Macro Programs
35AA (hex)	NONBTB	Variable rw	Mains-BTB Check On/Off
35AD (hex)	NREF	Variable rw	Homing Mode
35AE (hex)	O1	Variable rw	State of Digital Output 1
35AE (hex)	O3_18	Variable rw	State of Digital Output 1
35AF (hex)	O1MODE	Variable rw	Function of Digital Output 1
35AF (hex)	O3_18MODE	Variable rw	Function of Digital Output 1
35B0 (hex)	O1TRIG	Variable rw	Auxiliary Variable for O1MODE
35B0 (hex)	O3_18TRIG	Variable rw	Auxiliary Variable for O1MODE
35B1 (hex)	O2	Variable rw	State of Digital Output 2
35B2 (hex)	O2MODE	Variable rw	Function of Digital Output 2
35B3 (hex)	O2TRIG	Variable rw	Auxiliary Variable for O2MODE
35B4 (hex)	OPMODE	Variable rw	Operating Mode
35B5 (hex)	OPTION	Variable ro	Option Slot ID
35B6 (hex)	OVERRIDE	Variable rw	Override Function for Motion Tasks
35B7 (hex)	O_ACC	Variable rw	Acceleration Time 1 for Motion Task 0
35B9 (hex)	O_C	Variable rw	Control Variable for Motion Task 0
35BA (hex)	O_DEC	Variable rw	Braking Time 1 for Motion Task 0
35BC (hex)	O_FN	Variable rw	Next Task Number for Motion Task 0
35BD (hex)	O_FT	Variable rw	Delay before Next Motion Task
35BE (hex)	O_P	Variable rw	Target Position/Path for Motion Task 0

CAN Object number	ASCII Command	ASCII Type	Description
35BF (hex)	O_V	Variable rw	Target Speed for Motion Task 0
35C0 (hex)	PBAL	Variable ro	Actual Regen Power
35C1 (hex)	PBALMAX	Variable rw	Maximum Regen Power
35C2 (hex)	PBALRES	Variable rw	Select Regen Resistor
35C3 (hex)	PBAUD	Variable ro	Profibus Baud Rate
35C5 (hex)	PE	Variable ro	Actual Following Error
35C6 (hex)	PEINPOS	Variable rw	In-Position Window
35C7 (hex)	PEMAX	Variable rw	Max. Following Error
35C8 (hex)	PFB	Variable ro	Actual Position from Feedback Device
35C9 (hex)	PFB0	Variable ro	Position from External Encoder
35CA (hex)	PGEARI	Variable rw	Position Resolution (Numerator)
35CB (hex)	PGEARO	Variable rw	Position Resolution (Denominator)
35CC (hex)	PIOBUF	Variable rw	Profibus data
35CD (hex)	PMODE	Variable rw	Line Phase Mode
35CE (hex)	PNOID	Variable ro	PROFIBUS ID
35CF (hex)	POSCNFG	Variable rw	Axes T type
35D0 (hex)	PPOTYP	Variable rw	Profibus PPO Type
35D1 (hex)	PRBASE	Variable rw	Position Resolution
35D2 (hex)	PRD	Variable ro	20-bit Position Feedback
35D3 (hex)	PROMPT	Variable rw	Select RS232 Protocol
35D4 (hex)	PSTATE	Variable ro	Profibus Status
35D6 (hex)	PTMIN	Variable rw	Min. Acceleration Ramp for Motion Tasks
35D7 (hex)	PV	Variable ro	Actual Velocity (Position Control Loop)
35D8 (hex)	PVMAX	Variable rw	Max. Velocity for Position Control
35D9 (hex)	PVMAXN	Variable rw	Max. (Negative) Velocity for Position Control
35DB (hex)	PVMAXP	Variable rw	Max. Velocity for Position Control
35DD (hex)	READY	Variable ro	Status of the Software Enable
35DE (hex)	RECDONE	Variable ro	Scope: Recording Done
35DF (hex)	RECING	Variable ro	Scope: Recording in Progress
35E0 (hex)	RECOFF	Command	Scope: Cancel Scope Recording
35E1 (hex)	RECRDY	Variable ro	Scope: Status of RECORD Function
35E2 (hex)	REFIP	Variable rw	Peak Rated Current for Homing 7
35E4 (hex)	REMOTE	Variable ro	Status of the Hardware Enable
35E5 (hex)	RESPHASE	Variable rw	Resolver Phase
35E6 (hex)	RK	Variable rw	Gain Adjust for Resolver Sine Signal
35E7 (hex)	ROFFS	Variable rw	Reference Offset
35E8 (hex)	RS232T	Variable rw	RS232 Watch Dog
35E9 (hex)	RSTVAR	Command	Restore Variables (Default Values)
35EA (hex)	S	Command	Stop Motor and Disable Drive
35EB (hex)	SAVE	Command	Save Data in EEPROM
35EC (hex)	SBAUD	Variable rw	Sercos: Baud Rate
35ED (hex)	SCAN	Command	Detect CAN Stations
35EF (hex)	SERIALNO	Variable ro	Drive Serial Number
35F0 (hex)	SETREF	Command	Set Reference Point
35F2 (hex)	SLEN	Variable rw	Sercos Optical Range
35F3 (hex)	SLOTIO	Variable rw	I/O-Expansion Card: I/O States
35F4 (hex)	SPHAS	Variable rw	Sercos Phase
35FA (hex)	SSTAT	Variable ro	
35FA (hex)	DUMPSLNO	Variable rw	Listing of the numerical EEPROM-parameters
35FB (hex)	STAT	Variable ro	Drive Status Word
35FC (hex)	STATIO	Variable ro	I/O Status
35FD (hex)	STATUS	Variable ro	Detailed Amplifier Status
35FE (hex)	STOP	Command	Stop Motion Task
35FF (hex)	STOPMODE	Variable rw	Brake Response for Disable

CAN Object number	ASCII Command	ASCII Type	Description
3600 (hex)	SWCNFG	Variable rw	Configuration of software limit switches
3604 (hex)	SWE1	Variable rw	SW limit switch (smallest position)
3606 (hex)	SWE2	Variable rw	SW limit switch (biggest position)
360E (hex)	T	Command	Digital Current Setpoint
360F (hex)	TASK	Variable ro	Task Workload
3610 (hex)	TEMPE	Variable ro	Ambient Temperature
3611 (hex)	TEMPH	Variable ro	Heat Sink Temperature
3612 (hex)	TEMPM	Variable ro	Motor Temperature
3613 (hex)	TRJSTAT	Variable ro	Status2 Information
3614 (hex)	TRUN	Variable ro	Run-time counter
3617 (hex)	UVLTMODE	Variable rw	Undervoltage Mode
3618 (hex)	V	Variable ro	Actual Velocity
361A (hex)	VBUS	Variable ro	DC-bus voltage
361B (hex)	VBUSBAL	Variable rw	Maximum Line Voltage
361C (hex)	VBUSMAX	Variable ro	Maximum DC-bus Voltage
361D (hex)	VBUSMIN	Variable rw	Minimum DC-bus Voltage
361E (hex)	VCMD	Variable ro	Internal Velocity Setpoint in RPM
3620 (hex)	VEL0	Variable rw	Standstill Threshold
3621 (hex)	VJOG	Variable rw	Speed for Jog Mode
3622 (hex)	VLIMP	Variable rw	Max. Velocity
3623 (hex)	VLIMN	Variable rw	Max. Negative Velocity
3626 (hex)	VMUL	Variable rw	Velocity Scale Factor
3627 (hex)	VOSPD	Variable rw	Overspeed
3628 (hex)	VREF	Variable rw	Speed for Homing
3629 (hex)	VSCALE1	Variable rw	SW1 Velocity Scaling Factor
362A (hex)	VSCALE2	Variable rw	SW2 Velocity Scaling Factor
362B (hex)	\	Command	Selection of Remote Address
362C (hex)	DILIM	Variable rw	DPR current limit
362D (hex)	DENA	Variable rw	DPR software disable reset mode
362F (hex)	KTN	Variable rw	Current Controller Integral-Action Time
3630 (hex)	INPT0	Variable rw	In-Position Delay
3632 (hex)	COLDSTART	Command	Drive Reset
3636 (hex)	WPOS	Variable ro	Enable Position Registers
3637 (hex)	SRND	Variable rw	Start Position of Modulo Axes
3638 (hex)	ERND	Variable rw	End position of modulo axes
363A (hex)	BCC	Variable ro	EEPROM check sum
363C (hex)	REFMODE	Variable rw	Source of the Zero Pulse in Homing Mode
363D (hex)	VLO	Variable rw	Software Resolver/Digital Converter Feedforward
363E (hex)	WMASK	Variable rw	Warning as Fault Mask
363F (hex)	WPOSE	Variable ro	Enable Fast Position Registers 1 ... 16
3640 (hex)	WPOSP	Variable rw	Polarity of Fast Position Registers 1 ... 16
3641 (hex)	WPOSX	Variable rw	Mode of Fast Position Registers 1 ... 16
3642 (hex)	MOVE	Command	Start Motion Task
3643 (hex)	POSRSTAT	Variable rw	Status of Fast Position Registers 1 ... 16
3644 (hex)	P1	Variable rw	Fast Position Register
3645 (hex)	P2	Variable rw	Fast Position Register
3646 (hex)	P3	Variable rw	Fast Position Register
3647 (hex)	P4	Variable rw	Fast Position Register
3648 (hex)	P5	Variable rw	Fast Position Register
3649 (hex)	P6	Variable rw	Fast Position Register
364A (hex)	P7	Variable rw	Fast Position Register
364B (hex)	P8	Variable rw	Fast Position Register
364C (hex)	P9	Variable rw	Fast Position Register
364D (hex)	P10	Variable rw	Fast Position Register

CAN Object number	ASCII Command	ASCII Type	Description
364E (hex)	P11	Variable rw	Fast Position Register
364F (hex)	P12	Variable rw	Fast Position Register
3650 (hex)	P13	Variable rw	Fast Position Register
3651 (hex)	P14	Variable rw	Fast Position Register
3652 (hex)	P15	Variable rw	Fast Position Register
3653 (hex)	P16	Variable rw	Fast Position Register
3654 (hex)	PTARGET	Variable rw	Last Target Position
3655 (hex)	ACTRS232	Variable rw	Activate RS232 Watchdog
3656 (hex)	ROFFSABS	Variable rw	Reference Offset
3657 (hex)	FW	Variable ro	Displays the Version Number of the Firmware
3658 (hex)	DPRLIMIT	Variable rw	Digital Limiting of the peak Current via DPR
3659 (hex)	ACCUNIT	Variable rw	Type of acceleration setpoint for the system
365A (hex)	VCMM	Variable rw	Velocity Threshold for Commutation error
365B (hex)	MTMUX	Variable rw	Presetting for motion task that is processed later
365D (hex)	REFLS	Variable rw	
365F (hex)	VUNIT	Variable rw	Systemwide Definition of Velocity / Speed
3660 (hex)	PUNIT	Variable rw	Set Resolution of the Position
366E (hex)	TBRAKE	Variable rw	Disable Delaytime with Holding Brake
366F (hex)	TBRAKE0	Variable rw	Enable Delaytime with Holding Brake
3670 (hex)	CMDDLY	Variable rw	Command Delay Time for RS232
3671 (hex)	MSLBRAKE	Variable rw	DEC ramp at sensorless emergency stop
3672 (hex)	DRVCNFG	Variable rw	Configuration Variable for CAN-Bus
3673 (hex)	DISDPR	Variable rw	Disable DPR access
3675 (hex)	ESPEED	Variable ro	Maximum velocity corresponding to the Feedback Type
367F (hex)	LATCH1P16	Variable rw	Latched 16-bit Position (positive edge)
3680 (hex)	LATCH1N16	Variable rw	Latched 16-bit Position (negative edge)
3681 (hex)	EXTLATCH	Variable rw	Selection of the Source of the Latch Inputs
3682 (hex)	STAGECODE	Variable ro	Power Stage Identification
3683 (hex)	SYNCSRC	Variable rw	
3686 (hex)	MRS	Variable rw	Winding Resistance of the Stator Phase-Phase
3691 (hex)	SERCSET	Variable rw	Set Sercos Settings
3695 (hex)	SMNUMBER	Variable ro	Stored Motor Number in the feedback Device
3698 (hex)	VREF0	Variable rw	Homing Mode Reduction factor
3699 (hex)	AN11NR	Variable rw	No. Of INxTRIG variable, that is changed analog
369A (hex)	AN11RANGE	Variable rw	Range of the analog change of INxTRIG
36A3 (hex)	MSERIALNO	Variable rw	Serial no of the motor for encoder feedback
36A5 (hex)	VSTFR	Variable rw	Velocity for max. Friction Compensation
36B6 (hex)	DOVERRIDE	Variable rw	Digital Override Factor
36BE (hex)	INS0	Variable ro	State of Input A0 of the I/O Option Card
36BF (hex)	INS1	Variable ro	State of Input A1 of the I/O Option Card
36C0 (hex)	INS2	Variable ro	State of Input A2 of the I/O Option Card
36C1 (hex)	INS3	Variable ro	State of Input A3 of the I/O Option Card
36C2 (hex)	INS4	Variable ro	State of Input A4 of the I/O Option Card
36C3 (hex)	INS5	Variable ro	State of Input A5 of the I/O Option Card
36C4 (hex)	INS6	Variable ro	State of Input A6 of the I/O Option Card
36C5 (hex)	INS7	Variable ro	State of Input A7 of the I/O Option Card
36C6 (hex)	INS8	Variable ro	State of FSTART_IO of the I/O Option Card
36C7 (hex)	OS1	Variable rw	Set/Reset of "Posreg1" of the I/O Option Card
36C8 (hex)	OS2	Variable rw	Set/Reset of "Posreg2" of the I/O Option Card
36C9 (hex)	OS3	Variable rw	Set/Reset of "Posreg3" of the I/O Option Card
36CA (hex)	OS4	Variable rw	Set/Reset of "Posreg4" of the I/O Option Card
36CB (hex)	OS5	Variable rw	Set/Reset of "Posreg5" of the I/O Option Card
36CE (hex)	LASTWMASK	Variable ro	Fault history of WMASK
36D0 (hex)	WSTIME	Variable rw	Action Time of the W&S - Funktion

CAN Object number	ASCII Command	ASCII Type	Description
36D1 (hex)	WSAMPL	Variable rw	Minimum Move of W&S Mode
36D2 (hex)	NREFMT	Variable rw	Homing with following motion task
36D7 (hex)	AUTOHOME	Variable rw	
36D8 (hex)	PASSCNFG	Variable rw	Password Function
36E4 (hex)	DRVCNFG2	Variable rw	Additional drive functions
36E5 (hex)	BUSP1	Variable rw	State of the Modbus+ Network
36E6 (hex)	BUSP2	Variable rw	Number of Data Words (Command) at Modbus+
36E7 (hex)	BUSP3	Variable rw	Address selection of Modbus+
36E8 (hex)	BUSP4	Variable rw	Number of Data Words (Command) at Modbus+
36E9 (hex)	BUSP5	Variable rw	Number of Data Words (Command) at Modbus+
36EA (hex)	BUSP6	Variable rw	Number of Actual Value Data Words via Modbus
3890 (hex)	CSSTAT	Variable ro	Status (see SDO 2401h (→ # 104))
3891 (hex)	CSIOSTAT	Variable ro	Status (see SDO 2402h (→ # 104))
3892 (hex)	CSERR	Variable ro	Status (see SDO 2403h (→ # 104))
3893 (hex)	FBGEARI	Variable rw	compensation factor motor/gearing
3894 (hex)	FBGEARO	Variable rw	compensation factor motor/gearing
3895 (hex)	BCCOT	Variable ro	EEPROM check sum without life time counter
3896 (hex)	HLIMIT1	Variable rw	Software limit switch 1 for homing move
3897 (hex)	HLIMIT2	Variable rw	Software limit switch 2 for homing move
3898 (hex)	HLIMIT3	Variable rw	Software limit switch 3 for homing move
3899 (hex)	PASSPLC	Variable rw	Password value for PLC commands
389A (hex)	PASSXPLC	Variable rw	Password configuration for PLC commands
389B (hex)	PTARGOFFS	Variable rw	Motion tasks position target shift
389C (hex)	RSVERROFF	Variable rw	Resolver error supervision off
389D (hex)	DIRIN	Variable rw	polarity of the digital inputs
389E (hex)	RELTIME	Variable rw	switching on of the thyristor voltage control
38A0 (hex)	ANIN3	Variable ro	Voltage at analog input 3 (POS I/O)
38A1 (hex)	ANIN4	Variable ro	Voltage at analog input 4 (POS I/O)
38A2 (hex)	ANOFF3	Variable rw	Analog offset for analog input 3 (POS I/O)
38A3 (hex)	ANOFF4	Variable rw	Analog offset for analog input 4 (POS I/O)
38A4 (hex)	ANZERO3	Command	Zero analog input 3 (POS I/O)
38A5 (hex)	ANZERO4	Command	Zero analog input 4 (POS I/O)
38A6 (hex)	CALCPOSIO	Command	Initialisation of the POS I/O card
38A7 (hex)	GPTNTH1	Variable rw	integral part threshold for velocity set point
38A7 (hex)	GPTNTH2	Variable rw	integral part threshold for velocity actual value
36CC (hex)	GPTNTH3	Variable rw	integral part threshold for following error
38AF (hex)	GPDELAY	Variable rw	delay for external position set point
38B1 (hex)	GPTN	Variable rw	integral gain of the PI position loop
38B2 (hex)	GPTN_X	Variable rw	integral gain of the PI position loop
38B3 (hex)	MAXISETP	Variable rw	limitation of the integral part of the position loop
38B4 (hex)	MAXVSETP	Variable rw	limitation of the proportional part of the position loop
38B7 (hex)	BISSCNFG	Variable rw	configuration parameter for BiSS-C
38B9 (hex)	S1DLY	Variable rw	switch-on delay
38BB (hex)	TEMPMFLT	Variable rw	time constant for the filter of motor temperature sensors
38BE (hex)	EWH	Variable rw	consumed electric energy in watt-hours
38BF (hex)	VBUSBOFFS	Variable rw	abatement of the Regen switch on threshold
38C0 (hex)	VLO_X	Variable rw	Software resolver/digital converter feedforward
38C1 (hex)	VBUSRAMP	Variable rw	switching on threshold for the braking ramp control
38C2 (hex)	VBUSFACT	Variable rw	gain factor for the deceleration ramp control
38C3 (hex)	GP2	Variable rw	proportional gain for the velocity higher than GPS2
38C4 (hex)	GPS1	Variable rw	low velocity threshold (position loop)
38C5 (hex)	GPS2	Variable rw	high velocity threshold (position loop)
38C6 (hex)	GV2	Variable rw	proportional gain for the velocity higher than GVS2
38C7 (hex)	GVS1	Variable rw	low velocity threshold (velocity loop)

CAN Object number	ASCII Command	ASCII Type	Description
38C8 (hex)	GVS2	Variable rw	high velocity threshold (velocity loop)
38CA (hex)	CSCNFG	Variable rw	configuration Variable for safety card
38CB (hex)	CSEID	Variable rw	reactive current impression
38CC (hex)	CSIDMAX	Variable rw	Maximum value for reactive current command
38CE (hex)	DRVCNFG4	Variable rw	configuration parameter for additional drive functionality
38CF (hex)	MVANGLMODE	Variable rw	S600 compatibility mode for speed dependend phase lead
38D0 (hex)	VBUSOFFS	Variable rw	correction value for the regen threshold S748/772
38D1 (hex)	PMECH	Variable ro	estimated mechanical power delivered by the motor
38D2 (hex)	P	Variable ro	calculated active power (electrical)
38D3 (hex)	ENCFIX	Variable rw	Decimal places for the ENCLINES parameter
38D5 (hex)	LINRESOL	Variable rw	Conversion factor for linear measurement systems
38D6 (hex)	ENCDIV	Variable rw	Divisor for the decimal places of ENCLINE
38D7 (hex)	QCNFG	Variable rw	Configuration for the servo pump function
38D8 (hex)	QFACTOR	Variable rw	Swallowing capacity for the servo pump function
38D9 (hex)	QFCFACT	Variable ro	Swallowing capacity for the servo pump function
38DA (hex)	QMACT	Variable ro	Actual torque value for servo pump function
38DB (hex)	QTVEFF	Variable ro	Actual D-part for the servo pump control loop
38DD (hex)	QFSET	Variable ro	flow set point for servo pump (filtered)
38DE (hex)	QFACT	Variable ro	Flow actual value for servo pump
38DF (hex)	QPRSET	Variable rw	Pressure set point for servo pump
38E0 (hex)	QPRACT	Variable ro	Pressure actual value for servo pump
38E1 (hex)	QMCMD	Variable ro	Actual torque set point value for servo pump
38E2 (hex)	QFACTCOMP	Variable ro	Flow actual value for servo pump (compensated)
38E3 (hex)	QFACTFILT	Variable ro	Flow actual value for servo pump (filtered)
38E4 (hex)	QTIMEKD	Variable rw	Time constant of the D-Part for the servo pump loop
38E5 (hex)	QVT1	Variable rw	Time constant of the flow filter for the servo pump
38E6 (hex)	QMCMDLIM	Variable ro	Actual torque set point for the servo pump (after limitation)
38E7 (hex)	QMLIMP	Variable rw	Torque limitation for servo pump (pressure build-up)
38E9 (hex)	QFMAX	Variable rw	Max. flow max. set point value for servo pump
38EA (hex)	QPRMAX	Variable rw	Max. pressure set point for servo pump
38EB (hex)	QTAB1KP	Variable rw	Proportional gain 1 for servo pump loop
38EC (hex)	QTAB2KP	Variable rw	Proportional gain 2 for servo pump loop
38ED (hex)	QTAB3KP	Variable rw	Proportional gain 3 for servo pump loop
38EE (hex)	QTAB4KP	Variable rw	Proportional gain 4 for servo pump loop
38EF (hex)	QTAB5KP	Variable rw	Proportional gain 5 for servo pump loop
38F0 (hex)	QTAB1V	Variable rw	Velocity threshold 1 for servo pump loop
38F1 (hex)	QTAB2V	Variable rw	Velocity threshold 2 for servo pump loop
38F2 (hex)	QTAB3V	Variable rw	Velocity threshold 3 for servo pump loop
38F3 (hex)	QTAB4V	Variable rw	Velocity threshold 4 for servo pump loop
38F4 (hex)	QTAB5V	Variable rw	Velocity threshold 5 for servo pump loop
38F5 (hex)	QTAB1TN	Variable rw	Integral gain 1 for servo pump loop
38F6 (hex)	QTAB2TN	Variable rw	Integral gain 2 for servo pump loop
38F7 (hex)	QTAB3TN	Variable rw	Integral gain 3 for servo pump loop
38F8 (hex)	QTAB4TN	Variable rw	Integral gain 4 for servo pump loop
38F9 (hex)	QTAB5TN	Variable rw	Integral gain 5 for servo pump loop
38FA (hex)	QPE	Variable ro	Pressure following error for servo pump loop
38FB (hex)	QKPEFF	Variable ro	Actual proportional gain for the servo pump loop
38FC (hex)	QTNEFF	Variable ro	Actual integral gain for the servo pump loop
38FD (hex)	GVTV	Variable rw	Derivative time for the velocity loop
38FE (hex)	GVTV_X	Variable rw	Derivative time for the velocity loop (second parameter set)
3900 (hex)	QTABID	Variable ro	Actual gain set for servo pump loop
3901 (hex)	QTAB1TV	Variable rw	Derivative time 1 for servo pump loop

CAN Object number	ASCII Command	ASCII Type	Description
3902 (hex)	QTAB2TV	Variable rw	Derivative time 2 for servo pump loop
3903 (hex)	QTAB3TV	Variable rw	Derivative time 3 for servo pump loop
3904 (hex)	QTAB4TV	Variable rw	Derivative time 4 for servo pump loop
3905 (hex)	QTAB5TV	Variable rw	Derivative time 5 for servo pump loop
3907 (hex)	GFTN	Variable rw	time constant flow control induction machine)
3908 (hex)	MCFW	Variable rw	The Correction Factor of the Field Weakening
3909 (hex)	ENCDIVD	Variable rw	Divisor for the decimal places of ENCIN
390A (hex)	ENCFIXD	Variable rw	Decimal places for the ENCIN parameter
390B (hex)	SSITIME	Variable rw	SSI setting time
390C (hex)	SSIMASK	Variable rw	Filter mask for received SSI data
390D (hex)	EN22A1CNT	Variable ro	ENDAT2.2 state of the additional information 1
390E (hex)	EN22A2CNT	Variable ro	ENDAT2.2 state of the additional information 2
390F (hex)	EN22CNFG	Variable rw	ENDAT2.2 configuration parameter for diagnosis information
3910 (hex)	EN22DCNT	Variable ro	ENDAT2.2 status for diagnosis information
3911 (hex)	GV2_X	Variable rw	proportional gain for the velocity higher than GVS2
3912 (hex)	ZEROTIME	Variable rw	Default value for the ZERO function
3913 (hex)	QENA	Variable rw	Enable/disable servo pump function
3914 (hex)	QFCMD	Variable rw	flow set point for servo pump (unfiltered)
3916 (hex)	QT1	Variable rw	Flow filter time for servo pump
3917 (hex)	QMLIMN	Variable rw	Torque limitation for servo pump (pressure reduction)
3918 (hex)	HDSLTEMP	Variable ro	Motor/encoder temperature read from the HIPERFACE DSL
3919 (hex)	HDSLLED	Variable ro	LED current from HIPERFACE DSL
391A (hex)	HDSL VOLT	Variable ro	Voltage supply from the HIPERFACE DSL
391B (hex)	HDSLVEL	Variable ro	Actual velocity taken from the HIPERFACE DSL
391C (hex)	HDSLTIME	Variable ro	Operation-hour counter taken from HIPERFACE DSL
391D (hex)	HDSLROTAT	Variable ro	Rotation counter taken from HIPERFACE DSL

6.1.3 Object Dictionary

Index	Sub-Index	Data Type	Access	PDO mapp.	Description	ASCII object
1000h	0	UNSIGNED32	ro	—	Device type	—
1001h	0	UNSIGNED8	ro	—	Error register	—
1002h	0	UNSIGNED32	ro	yes	Manufacturer specific status register	—
1003h		ARRAY			Pre-defined error field	—
	0	UNSIGNED8	rw	—	Number of errors	—
	1...8	UNSIGNED32	ro	—	standard error field	—
1005h	0	UNSIGNED32	rw	—	COB-ID SYNC message	—
1006h	0	UNSIGNED32	rw	no	Communication cycle period	—
1008h	0	Visible String	const	—	Manufacturer device name	—
1009h	0	Visible String	const	—	Manufacturer hardware version	—
100Ah	0	Visible String	const	—	Manufacturer software version	—
100Ch	0	UNSIGNED16	rw	—	Guard time	—
100Dh	0	UNSIGNED8	rw	—	Lifetime factor	—
1010h	0	UNSIGNED8	ro	—	Number of entries	—
	1	UNSIGNED32	rw	—	Save all parameters	SAVE
1011h	0	UNSIGNED8	ro	—	Number of entries	—
	1	UNSIGNED32	rw	—	Restore all default parameters	RSTVAR
1014h	0	UNSIGNED32	rw	—	COB-ID for the Emergency Object	—
1016h		RECORD			Consumer heartbeat time	—
	0	UNSIGNED8	ro	—	Number of entries	—
	1	UNSIGNED32	rw	—	Consumer heartbeat time	—
1017h	0	UNSIGNED16	rw	—	Producer heartbeat time	—
1018h		RECORD			Identity Object	—
	0	UNSIGNED8	ro	—	Number of entries	—
	1	UNSIGNED32	ro	—	Vendor ID	—
	2	UNSIGNED32	ro	—	Product Code	—
	3	UNSIGNED32	ro	—	Revision number	—
	4	UNSIGNED32	ro	—	Serial number	SERIALNO
1026h		ARRAY			OS prompt	—
	0	UNSIGNED8	ro	—	Number of entries	—
	1	UNSIGNED8	w	—	StdIn	—
	2	UNSIGNED8	ro	—	StdOut	—
1400h		RECORD			RXPDO1 communication parameter	—
	0	UNSIGNED8	ro	—	Number of entries	—
	1	UNSIGNED32	rw	—	RXPDO1 COB - ID	—
	2	UNSIGNED8	rw	—	Transmission type RXPDO1	—
1401h		RECORD			RXPDO2 communication parameter	—
	0	UNSIGNED8	ro	—	Number of entries	—
	1	UNSIGNED32	rw	—	RXPDO2 COB - ID	—
	2	UNSIGNED8	rw	—	Transmission type RXPDO2	—
1402h		RECORD			RXPDO3 communication parameter	—
	0	UNSIGNED8	ro	—	Number of entries	—
	1	UNSIGNED32	rw	—	RXPDO3 COB - ID	—
	2	UNSIGNED8	rw	—	Transmission type RXPDO3	—
1403h		RECORD			RXPDO4 communication parameter	—
	0	UNSIGNED8	ro	—	Number of entries	—
	1	UNSIGNED32	rw	—	RXPDO4 COB - ID	—
	2	UNSIGNED8	rw	—	Transmission type RXPDO4	—
1600h		RECORD			RXPDO1 mapping parameter	—
	0	UNSIGNED8	ro	—	Number of entries	—
	1...8	UNSIGNED32	rw	—	Mapping for n-th application object	—
1601h		RECORD			RXPDO2 mapping parameter	—
	0	UNSIGNED8	ro	—	Number of entries	—
	1...8	UNSIGNED32	rw	—	Mapping for n-th application object	—

Index	Sub-Index	Data Type	Access	PDO mapp.	Description	ASCII object
1602h		RECORD			RXPDO3 mapping parameter	—
	0	UNSIGNED8	ro	—	Number of entries	—
	1..8	UNSIGNED32	rw	—	Mapping for n-th application object	—
1603h		RECORD			RXPDO4 mapping parameter	—
	0	UNSIGNED8	ro	—	Number of entries	—
	1..8	UNSIGNED32	rw	—	Mapping for n-th application object	—
1800h		RECORD			TXPDO1 communication parameter	—
	0	UNSIGNED8	ro	—	Number of entries	—
	1	UNSIGNED32	rw	—	TXPDO1 COB-ID	—
	2	UNSIGNED8	rw	—	Transmission type TXPDO1	—
	3	UNSIGNED16	rw	—	Inhibit time	—
	4	UNSIGNED8	const	—	reserved	—
	5	UNSIGNED16	rw	—	event timer	—
1801h		RECORD			TXPDO2 communication parameter	—
	0	UNSIGNED8	ro	—	Number of entries	—
	1	UNSIGNED32	rw	—	TXPDO2 COB-ID	—
	2	UNSIGNED8	rw	—	Transmission type TXPDO2	—
	3	UNSIGNED16	rw	—	Inhibit time	—
	4	UNSIGNED8	const	—	reserved	—
	5	UNSIGNED16	rw	—	event timer	—
1802h		RECORD			TXPDO3 communication parameter	—
	0	UNSIGNED8	ro	—	Number of entries	—
	1	UNSIGNED32	rw	—	TXPDO3 COB-ID	—
	2	UNSIGNED8	rw	—	Transmission type TXPDO3	—
	3	UNSIGNED16	rw	—	Inhibit time	—
	4	UNSIGNED8	const	—	reserved	—
	5	UNSIGNED16	rw	—	event timer	—
1803h		RECORD			TXPDO4 communication parameter	—
	0	UNSIGNED8	ro	—	Number of entries	—
	1	UNSIGNED32	rw	—	TXPDO4 COB-ID	—
	2	UNSIGNED8	rw	—	Transmission type TXPDO4	—
	3	UNSIGNED16	rw	—	Inhibit time	—
	4	UNSIGNED8	const	—	reserved	—
	5	UNSIGNED16	rw	—	event timer	—
1A00h		RECORD			Mapping parameter TXPDO1	—
	0	UNSIGNED8	ro	—	Number of entries	—
	1..8	UNSIGNED32	rw	—	Mapping for n-th application object	—
1A01h		RECORD			Mapping parameter TXPDO2	—
	0	UNSIGNED8	ro	—	Number of entries	—
	1..8	UNSIGNED32	rw	—	Mapping for n-th application object	—
1A02h		RECORD			Mapping parameter TXPDO3	—
	0	UNSIGNED8	ro	—	Number of entries	—
	1..8	UNSIGNED32	rw	—	Mapping for n-th application object	—
1A03h		RECORD			Mapping parameter TXPDO4	—
	0	UNSIGNED8	ro	—	Number of entries	—
	1..8	UNSIGNED32	rw	—	Mapping for n-th application object	—
2000h	0	UNSIGNED32	ro	yes	Manufacturer warnings	STATCODE
2014h	0	ARRAY	ro	—	Mask TxPDO Channel 1	—
	1	UNSIGNED32	rw	—	Mask (Byte 0..3)	—
	2	UNSIGNED32	rw	—	Mask (Byte 4..7)	—
2015h	0	ARRAY	ro	—	Mask TxPDO Channel 2	—
	1	UNSIGNED32	rw	—	Mask (Byte 0..3)	—
	2	UNSIGNED32	rw	—	Mask (Byte 4..7)	—

Index	Sub-Index	Data Type	Access	PDO mapp.	Description	ASCII object
2016h	0	ARRAY	ro	—	Mask TxPDO Channel 3	—
	1	UNSIGNED32	rw	—	Mask (Byte 0..3)	—
	2	UNSIGNED32	rw	—	Mask (Byte 4..7)	—
2017h	0	ARRAY	ro	—	Mask TxPDO Channel 4	—
	1	UNSIGNED32	rw	—	Mask (Byte 0..3)	—
	2	UNSIGNED32	rw	—	Mask (Byte 4..7)	—
2030h		ARRAY			DP-Ram Variablen, write only (PDO)	-
	0	UNSIGNED8	ro	-	Anzahl der Einträge	-
	1	INTEGER32	rw	yes	DP-Ram Variable 9	DPRVAR9
	2	INTEGER32	rw	yes	DP-Ram Variable 10	DPRVAR10
	3	INTEGER32	rw	yes	DP-Ram Variable 11	DPRVAR11
	4	INTEGER32	rw	yes	DP-Ram Variable 12	DPRVAR12
	5	INTEGER32	rw	yes	DP-Ram Variable 13	DPRVAR13
	6	INTEGER32	rw	yes	DP-Ram Variable 14	DPRVAR14
	7	INTEGER32	rw	yes	DP-Ram Variable 15	DPRVAR15
8	INTEGER32	rw	yes	DP-Ram Variable 16	DPRVAR16	
2040h		RECORD			Gearing factors for electronic gearing	—
	0	UNSIGNED8		—	Number of entries	—
	1	INTEGER32	rw	yes	input factor for electronic gearing	GEARI
	2	UNSIGNED32	rw	yes	output factor for electronic gearing	GEARO
2041h		RECORD			Actual values electr. gearing	-
	0	UNSIGNED8	ro	-	Number of entries	-
	1	INTEGER32	ro	yes	Slave velocity set point	-
	2	INTEGER32	ro	yes	Master velocity	-
2051h	3	UNSIGNED8	ro	yes	Internal control word for electr. gearing	-
		ARRAY			Configuration of Position Registers	-
	0	UNSIGNED8	ro	-	Number of entries	-
	1	UNSIGNED32	rw	yes	Position register Enable	WPOSE
	2	UNSIGNED32	rw	yes	Position register Mode	WPOSX
2052h	3	UNSIGNED32	rw	yes	Polarity of the position registers	WPOSP
		ARRAY			Position registers, absolute	-
	0	UNSIGNED8	ro	-	Number of entries	-
	1	INTEGER32	rw	yes	Position register 1, absolute	P1
	2	INTEGER32	rw	yes	Position register 2, absolute	P2
	3	INTEGER32	rw	yes	Position register 3, absolute	P3
	4	INTEGER32	rw	yes	Position register 4, absolute	P4
	5	INTEGER32	rw	yes	Position register 5, absolute	P5
	6	INTEGER32	rw	yes	Position register 6, absolute	P6
	7	INTEGER32	rw	yes	Position register 7, absolute	P7
	8	INTEGER32	rw	yes	Position register 8, absolute	P8
	9	INTEGER32	rw	yes	Position register 9, absolute	P9
	10	INTEGER32	rw	yes	Position register 10, absolute	P10
	11	INTEGER32	rw	yes	Position register 11, absolute	P11
	12	INTEGER32	rw	yes	Position register 12, absolute	P12
	13	INTEGER32	rw	yes	Position register 13, absolute	P13
	14	INTEGER32	rw	yes	Position register 14, absolute	P14
15	INTEGER32	rw	yes	Position register 15, absolute	P15	
16	INTEGER32	rw	yes	Position register 16, absolute	P16	

Index	Sub-Index	Data Type	Access	PDO mapp.	Description	ASCII object
2053h		ARRAY			Position registers, relative	-
	0	UNSIGNED8	ro	-	Number of entries	-
	1	INTEGER32	rw	yes	Position register 1, relative	P1
	2	INTEGER32	rw	yes	Position register 2, relative	P2
	3	INTEGER32	rw	yes	Position register 3, relative	P3
	4	INTEGER32	rw	yes	Position register 4, relative	P4
	5	INTEGER32	rw	yes	Position register 5, relative	P5
	6	INTEGER32	rw	yes	Position register 6, relative	P6
	7	INTEGER32	rw	yes	Position register 7, relative	P7
	8	INTEGER32	rw	yes	Position register 8, relative	P8
	9	INTEGER32	rw	yes	Position register 9, relative	P9
	10	INTEGER32	rw	yes	Position register 10, relative	P10
	11	INTEGER32	rw	yes	Position register 11, relative	P11
	12	INTEGER32	rw	yes	Position register 12, relative	P12
	13	INTEGER32	rw	yes	Position register 13, relative	P13
	14	INTEGER32	rw	yes	Position register 14, relative	P14
	15	INTEGER32	rw	yes	Position register 15, relative	P15
16	INTEGER32	rw	yes	Position register 16, relative	P16	
2061h	0	UNSIGNED16	rw	yes	Current limitation for velocity mode	DPRLIMIT
2080h	0	UNSIGNED16	rw	yes	Motion task for profile position mode	—
2081h	0	UNSIGNED16	rw	yes	Active motion task display	MOVE
2082h	0	UNSIGNED32	wo	—	Copy motion task	OCOPY
2083h	0	UNSIGNED32	wo	—	Erase flash motion tasks	—
2090h		ARRAY			DP-Ram Variables, read only	-
	0	UNSIGNED8	ro	-	Number of entries	-
	1	INTEGER32	ro	yes	DP-Ram Variable 1	DPRVAR1
	2	INTEGER32	ro	yes	DP-Ram Variable 2	DPRVAR2
	3	INTEGER32	ro	yes	DP-Ram Variable 3	DPRVAR3
	4	INTEGER32	ro	yes	DP-Ram Variable 4	DPRVAR4
	5	INTEGER32	ro	yes	DP-Ram Variable 5	DPRVAR5
	6	INTEGER32	ro	yes	DP-Ram Variable 6	DPRVAR6
	7	INTEGER32	ro	yes	DP-Ram Variable 7	DPRVAR7
8	INTEGER32	ro	yes	DP-Ram Variable 8	DPRVAR8	
20A0h	0	INTEGER32	ro	yes	Latch position 1, positive edge	LATCH1P32
20A1h	0	INTEGER32	ro	yes	Latch position 1, negative edge	LATCH1N32
20A2h	0	INTEGER32	ro	yes	Latch position 2, positive edge	LATCH2P32
20A3h	0	INTEGER32	ro	yes	Latch position 2, negative edge	LATCH2N32
20A4h	0	UNSIGNED8	rw	yes	Latch control register	-
20B0h	0	INTEGER32	rw	yes	Trigger variable digital input 20	IN20TRIG
20B1h	0	UNSIGNED32	rw	yes	Controlword digital inputs 5 .. 20	IN5 .. IN20
20B2h		ARRAY			Analog Inputs	-
	0	UNSIGNED8	ro	—	Number of entries	-
	1	INTEGER16	ro	yes	Voltage analog input 1	ANIN1
	2	INTEGER16	ro	yes	Voltage analog input 2	ANIN2
2100h	0	UNSIGNED32	rw	yes	Write Dummy	-
2101h	0	UNSIGNED32	ro	yes	Read Dummy	-
2400h		RECORD			Safety card serial number	—
	0	UNSIGNED8	ro	—	Number of entries	—
	1-6	UNSIGNED32	ro	—	Safety card serial number part 1-6	—
2401h	0	UNSIGNED32	ro	yes	Safety card status	CSSTAT
2402h	0	UNSIGNED32	ro	yes	Safety card I/O status	CSIOSTAT
2403h	0	UNSIGNED32	ro	yes	Safety card error register	CSERR

Index	Sub-Index	Data Type	Access	PDO mapp.	Description	ASCII object
2404h		RECORD			Safety card error stack error number	—
	0	UNSIGNED8	ro	—	Number of entries	—
	1-128	UNSIGNED32	ro	—	Error Stack – Error Number 1...128	—
2405h		RECORD			Fehlerstack – Error Time	—
	0	UNSIGNED8	ro	—	Number of entries	—
	1-128	UNSIGNED32	ro	—	Error Stack – Error Time 1...128	—
2406h		RECORD			Fehlerstack – Error Index	—
	0	UNSIGNED8	ro	—	Number of entries	—
	1-128	UNSIGNED32	ro	—	Error Stack – Error Index 1...128	—
2407h		RECORD			Error Stack – Error Info	—
	0	UNSIGNED8	ro	—	Number of entries	—
	1-128	UNSIGNED32	ro	—	Error Stack – Error Info 1...128	—
2408h		RECORD			Error Stack – Error Parameter 1	—
	0	UNSIGNED8	ro	—	Number of entries	—
	1-128	UNSIGNED32	ro	—	Error Stack – Parameter 1 Error 1...128	—
2409h		RECORD			Error Stack – Error Parameter 2	—
	0	UNSIGNED8	ro	—	Number of entries	—
	1-128	UNSIGNED32	ro	—	Error Stack – Parameter 2 Error 1...128	—
240Ah		RECORD			Error Stack – Error Parameter 3	—
	0	UNSIGNED8	ro	—	Number of entries	—
	1-128	UNSIGNED32	ro	—	Error Stack – Parameter 3 Error 1...128	—
240Bh		RECORD			Error Stack – Error Parameter 4	—
	0	UNSIGNED8	ro	—	Number of entries	—
	1-128	UNSIGNED32	ro	—	Error Stack – Parameter 4 Error 1...128	—
240Ch	0	UNSIGNED32	ro	yes	Safety card actual speed	—
3500h		RECORD			ASCII Command MAXCMD	MAXCMD
	0	UNSIGNED8	ro	—	Number of entries	—
	1	UNSIGNED32	ro	—	Value	—
	2	UNSIGNED32	ro	—	Lower limit value	—
	3	UNSIGNED32	ro	—	Upper limit value	—
	4	UNSIGNED32	ro	—	Default value	—
	5	UNSIGNED32	ro	—	Parameter format	—
	6	UNSIGNED32	ro	—	Parameter control data	—
	7	UNSIGNED32	ro	—	reserved	—
8	UNSIGNED32	ro	—	reserved	—	
3500h+MAXCMD		RECORD			Last entry of the ASCII Object Chanel	—
6040h	0	UNSIGNED16	w	yes	control word	—
6041h	0	UNSIGNED16	ro	yes	status word	—
6060h	0	INTEGER8	rw	yes	Modes of Operation	—
6061h	0	INTEGER8	ro	yes	Modes of Operation Display	—
6063h	0	INTEGER32	ro	yes	Position actual value (increments)	—
6064h	0	INTEGER32	ro	yes	Position actual value (position units)	PFB
6065h	0	UNSIGNED32	rw	—	Following error window	PEMAX
6067h	0	UNSIGNED32	rw	—	Position window	PEINPOS
6068h	0	UNSIGNED16	rw	—	Position window time	INPT1
606Ch	0	INTEGER32	ro	yes	Velocity actual value	—
6071h	0	INTEGER16	rw	yes	Target torque	—
6073h	0	UNSIGNED16	rw	—	Max current	MIPEAK
6077h	0	INTEGER16	ro	yes	Torque actual value	—
607Ah	0	INTEGER32	rw	yes	Target position	O_P
607Ch	0	INTEGER32	rw	—	Reference offset	ROFFS

Index	Sub-Index	Data Type	Access	PDO mapp.	Description	ASCII object
607Dh		ARRAY			Software position limit	
	0	UNSIGNED8	ro	—	Number of entries	
	1	INTEGER32	rw	—	Software position limit 1	SWE1
	2	INTEGER32	rw	—	Software position limit 2	SWE2
607Fh	0	UNSIGNED32	rw	—	Max profile velocity	PVMAX
6080h	0	UNSIGNED32	rw	—	Max motor speed	VLIM
6081h	0	UNSIGNED32	rw	yes	Profile Velocity	O_V
6083h	0	UNSIGNED32	rw	yes	Profile Acceleration	O_ACC (pp)/ ACC (pv)
6084h	0	UNSIGNED32	rw	yes	Profile Deceleration	O_DEC (pp)/ DEC (pv)
6085h	0	UNSIGNED32	rw	—	Quick stop deceleration	DECSTOP
6086h	0	INTEGER16	rw	yes	Motion profile type	O_C
6089h	0	INTEGER8	rw	—	Position Notation index	—
608Ah	0	UNSIGNED8	rw	—	Position Dimension index	—
608Bh	0	INTEGER8	rw	—	Velocity Notation index	—
608Ch	0	UNSIGNED8	rw	—	Velocity Dimension index	—
608Dh	0	INTEGER8	rw	—	Acceleration Notation index	—
608Eh	0	UNSIGNED8	rw	—	Acceleration Dimension index	—
608Fh		ARRAY			Position encoder resolution	—
	0	UNSIGNED8	ro	—	Number of entries	—
	1	UNSIGNED32	rw	—	Encoder increments	PGEARO
	2	UNSIGNED32	rw	—	Motor revolutions	BUSP7
6090h		ARRAY			Velocity encoder resolution	—
	0	UNSIGNED8	ro	—	Number of entries	—
	1	UNSIGNED32	rw	—	Encoder increments per second	—
	2	UNSIGNED32	rw	—	Motor revolutions per second	—
6091h		ARRAY			Gear ratio	—
	0	UNSIGNED8	ro	—	Number of entries	—
	1	UNSIGNED32	rw	—	Motor revolutions	—
	2	UNSIGNED32	rw	—	Shaft revolutions	—
6092h		ARRAY			Feed constant	—
	0	UNSIGNED8	ro	—	Number of entries	—
	1	UNSIGNED32	rw	—	Feed	PGEARI
	2	UNSIGNED32	rw	—	Shaft revolutions	—
6093h		ARRAY			Position factor	—
	0	UNSIGNED8	ro	—	Number of entries	—
	1	UNSIGNED32	rw	—	Numerator	—
	2	UNSIGNED32	rw	—	Feed constant	—
6094h		ARRAY			Velocity encoder factor	—
	0	UNSIGNED8	ro	—	Number of entries	—
	1	UNSIGNED32	ro	—	Numerator	—
	2	UNSIGNED32	ro	—	Denominator	—
6097h		ARRAY			Acceleration factor	—
	0	UNSIGNED8	ro	—	Number of entries	—
	1	UNSIGNED32	rw	—	Numerator	—
	2	UNSIGNED32	rw	—	Denominator	—
6098h	0	INTEGER8	rw	—	Homing type	NREF, DREF
6099h		ARRAY			Homing velocity	—
	0	UNSIGNED8	ro	—	Number of entries	—
	1	UNSIGNED32	rw	—	Speed while searching for limit switch	VREF
	2	UNSIGNED32	rw	—	Speed while searching for zero mark	VREF0
609Ah	0	UNSIGNED32	rw	—	Homing acceleration	ACCR, DECR

Index	Sub-Index	Data Type	Access	PDO mapp.	Description	ASCII object
60C0h	0	INTEGER8	rw	—	Interpolation submode select	—
60C1h		ARRAY			Interpolation data record	—
	0	UNSIGNED8	ro	—	Number of entries	—
	1	INTEGER32	rw	yes	x1, first parameter of ip function	—
60C2h		RECORD			Interpolation time period	—
	0	UNSIGNED8	ro	—	Number of entries	PTBASE
	1	UNSIGNED8	rw	—	Interpolation time units	—
	2	INTEGER16	rw	—	Interpolation time index	—
60C3h		ARRAY			Interpolation sync definition	—
	0	UNSIGNED8	ro	—	Number of entries	—
	1	UNSIGNED8	rw	—	Synchronize on group	—
	2	UNSIGNED8	rw	—	ip sync every n event	—
60C4h		RECORD			Interpolation data configuration	—
	0	UNSIGNED8	ro	—	Number of entries	—
	1	UNSIGNED32	ro	—	Maximum buffer size	—
	2	UNSIGNED32	rw	—	Actual buffer size	—
	3	UNSIGNED8	rw	—	Buffer organization	—
	4	UNSIGNED16	rw	—	Buffer position	—
	5	UNSIGNED8	w	—	Size of data record	—
60C5h	0	UNSIGNED32	rw	—	Max acceleration /deceleration	—
60C4h	6	UNSIGNED8	w	—	Buffer clear	—
60F4h	0	INTEGER32	ro	yes	Following error actual value	PE
60FDh	0	UNSIGNED32	ro	yes	Digital inputs	IN1 .. IN4
60FFh	0	INTEGER32	rw	yes	Target velocity	J
6502h	0	UNSIGNED32	ro	—	Supported drive modes	—

6.2 CANopen SDOs for Safety Expansion Card S1/S2/S1-2/S2-2

The Safety expansion cards S1, S2, S3, S4 can be used with S700 from Hardware Revision 2.10 only.

6.2.1 Object 2400h: Safety card serial number

The serial number of the safety card must be filled in the configurator software. The number is printed on the safety card front cover. It is separated to six 32 bit blocks, every byte codes one ASCII character. End of string is coded by 0h.

Index	2400h
Name	Safety card serial number
Object code	Record
Category	optional
Subindex	0
Description	number of entries
Data type	UNSIGNED8
Category	optional
Access	ro
PDO mapping	not possible
Value range	6
Default value	6
Subindex	1 to 6
Description	Safety card serial number part 1 to 6
Data type	UNSIGNED32
Category	optional
Access	ro
PDO mapping	not possible
Value range	UNSIGNED32
Default value	—

6.2.2 Object 2401h: Safety card status

Index	2401h
Name	Safety card status
Object code	VAR
Data type	UNSIGNED32
Category	optional
Access	ro
PDO mapping	possible
Value range	UNSIGNED32
Default value	—

Bit	Meaning
0	Status LED 'POWER' on safety card front cover
1	Status LED 'RUN' on safety card front cover
2	Status LED 'CONFIG' on safety card front cover
3	Status LED 'FAULT' on safety card front cover
4	Status internal 'STO' (0 = STO not active, 1 = STO active)
5	OK message if configuration data download was successful
8	Bit is set if safety card status is 'STARTUP'
9	Bit is set if safety card status is 'RUN'
10	Bit is set if safety card status is 'STOP'
11	Bit is set if safety card status is 'CONFIG'

6.2.3 Object 2402h: Safety card I/O status

Index	2402h
Name	Safety card I/O status
Object code	VAR
Data type	UNSIGNED32
Category	optional
Access	ro
PDO mapping	possible
Value range	UNSIGNED32
Default value	—

Bit	Meaning
0	Status input 'SS1 Activate'
1	Status input 'SS2 Activate'
2	Status input 'SOS Activate'
3	Status input 'SLS Activate'
4	Status input 'SSR Activate'
5	Status input 'SDI Left Activate'
6	Status input 'SDI Right Activate'
7	Status input 'SBT Activate'
8	Status output 'Ready'
9	Status output 'STO Acknowledge'
10	Status output 'SOS Acknowledge'
11	Status output 'SDI Acknowledge'
12	Status output 'Safe Range Acknowledge'
13	Status output 'SBT Acknowledge'
14	Status 2 pole output 'Safe Brake Control' (external brake)
15	Status output 'STO SIL3' (second switch off line)
16	Status input 'SS1 SIL3/Reset'
29	Brake ramp control SS2 (0=drive control, 1=PLC control)
30	Brake ramp control SS1 (0=drive control, 1=PLC control)
31	Emergency stop ramp with SS1 (0=not active, 1=active)

6.2.4 Object 2403h: Safety card error register

Index	2403h
Name	Safety card error register
Object code	VAR
Data type	UNSIGNED32
Category	optional
Access	ro
PDO mapping	possible
Value range	UNSIGNED32
Default value	0

Bit	Meaning
0	Error with safety function 'Safe Stop 1' SS1
1	Error with safety function 'Safe Stop 2' SS2
2	Error with safety function 'Safe Operating Stop' SOS
3	Error with safety function 'Safely Limited Speed' SLS
4	Error with safety function 'Safe Speed Range' SSR
5	Error with safety function 'Safe Direction' SDI
6	Error with safety function 'Safe Brake Test' SBT
11	Error with wiring of digital inputs
12	Error wiring / feedback digital outputs
13	Error with voltage supervision test
14	Error with watchdog test (start, stop)
15	Error with memory test (Flash/RAM)
16	Timing error (interrupt supervision)
17	Position supervision by current signal
18	Position supervision by feedback signal (internal, external, set point)
19	Parameter error (servo amplifier)
20	Input states / configuration data don't match to each other
21	Error data check Channel A-B
24	Error with write/delete in flash memory
25	Time synchronization of channels A and B
26	Watchdog triggered
27	Data / parameter check (data transmission / configuration)
28	Timeout during transmission of data/parameter
29	Error CRC check
30	Error device data check (serial number, version)
31	Fatal error system software

6.2.5 Object 2404h: Safety card error stack error number

Error numbers of the entries.

The error stack can be requested by SDOs 2404h to 240Bh. Identical subindices always corresponds to each other. A complete entry would be for example 2404h to 240Bh always with subindex 5.

Index	2404h
Name	Safety card error stack error number
Object code	Record
Category	optional
Subindex	0
Description	number of entries
Data type	UNSIGNED8
Category	optional
Access	ro
PDO mapping	not possible
Value range	0...128
Default value	0
Subindex	1 to 128
Description	Safety card error stack error number X
Data type	UNSIGNED32
Category	optional
Access	ro
PDO mapping	not possible
Value range	UNSIGNED32
Default value	0

6.2.6 Object 2405h: Safety card error stack error time

Time index were the error occurred.

Index	2405h
Name	Safety card error stack error time
Object code	Record
Category	optional
Subindex	0
Description	number of entries
Data type	UNSIGNED8
Category	optional
Access	ro
PDO mapping	not possible
Value range	0...128
Default value	0
Subindex	1 to 128
Description	Safety card error stack error time X
Data type	UNSIGNED32
Category	optional
Access	ro
PDO mapping	not possible
Value range	UNSIGNED32
Default value	0

6.2.7 Object 2406h: Safety card error stack error index

Detailed error code (suberror code).

Index	2406h
Name	Safety card error stack error index
Object code	Record
Category	optional
Subindex	0
Description	number of entries
Data type	UNSIGNED8
Category	optional
Access	ro
PDO mapping	not possible
Value range	0...128
Default value	0
Subindex	1 to 128
Description	Safety card error stack error index X
Data type	UNSIGNED32
Category	optional
Access	ro
PDO mapping	not possible
Value range	UNSIGNED32
Default value	0

6.2.8 Object 2407h: Safety card error stack error info

Indicates the channel where the error occurred and the current error state:

Bit 0 = Channel A

Bit 1 = Channel B

Bit 2 = Error still occurs

Index	2407h
Name	Safety card error stack error info
Object code	Record
Category	optional
Subindex	0
Description	number of entries
Data type	UNSIGNED8
Category	optional
Access	ro
PDO mapping	not possible
Value range	0...128
Default value	0
Subindex	1 to 128
Description	Safety card error stack error info X
Data type	UNSIGNED32
Category	optional
Access	ro
PDO mapping	not possible
Value range	UNSIGNED32
Default value	0

6.2.9 Object 2408h: Safety card error stack error parameter 1

Error specific additional information.

Index	2408h
Name	Safety card error stack error parameter 1
Object code	Record
Category	optional
Subindex	0
Description	number of entries
Data type	UNSIGNED8
Category	optional
Access	ro
PDO mapping	not possible
Value range	0...128
Default value	0
Subindex	1 to 128
Description	Safety card error stack error parameter 1 of error X
Data type	UNSIGNED32
Category	optional
Access	ro
PDO mapping	not possible
Value range	UNSIGNED32
Default value	0

6.2.10 Object 2409h: Safety card error stack error parameter 2

Error specific additional information.

Index	2409h
Name	Safety card error stack error parameter 2
Object code	Record
Category	optional
Subindex	0
Description	number of entries
Data type	UNSIGNED8
Category	optional
Access	ro
PDO mapping	not possible
Value range	0...128
Default value	0
Subindex	1 to 128
Description	Safety card error stack error parameter 2 of error X
Data type	UNSIGNED32
Category	optional
Access	ro
PDO mapping	not possible
Value range	UNSIGNED32
Default value	0

6.2.11 Object 240Ah: Safety card error stack error parameter 3

Error specific additional information.

Index	240Ah
Name	Safety card error stack error parameter 3
Object code	Record
Category	optional
Subindex	0
Description	number of entries
Data type	UNSIGNED8
Category	optional
Access	ro
PDO mapping	not possible
Value range	0...128
Default value	0
Subindex	1 to 128
Description	Safety card error stack error parameter 3 of error X
Data type	UNSIGNED32
Category	optional
Access	ro
PDO mapping	not possible
Value range	UNSIGNED32
Default value	0

6.2.12 Object 240Bh: Safety card error stack error parameter 4

Error specific additional information.

Index	240Bh
Name	Safety card error stack error parameter 4
Object code	Record
Category	optional
Subindex	0
Description	number of entries
Data type	UNSIGNED8
Category	optional
Access	ro
PDO mapping	not possible
Value range	0...128
Default value	0
Subindex	1 to 128
Description	Safety card error stack error parameter 4 of error X
Data type	UNSIGNED32
Category	optional
Access	ro
PDO mapping	not possible
Value range	UNSIGNED32
Default value	0

6.2.13 Object 240Ch: Actual speed

Actual speed in 4096/Second.

Index	240Ch
Name	Safety card actual speed
Object code	VAR
Data type	UNSIGNED32
Category	optional
Access	ro
PDO mapping	possible
Value range	UNSIGNED32
Default value	—

6.3 Examples

All examples are valid for S300/S700. All values are hexadecimal.

6.3.1 Basic testing of the connection to the S300/S700 controls

When the S300/S700 is switched on, a boot-up message is transmitted over the bus. The telegram continues to be transmitted, as long as it has not yet found a suitable receiver in the bus system.

If a CAN master is unable to recognize this message, then the following measures can be taken to test communication:

- Check the bus cable: correct characteristic impedance, correct termination resistors at both ends?
- With a multimeter: check the quiescent level of the bus cables CAN-H and CAN-L against CAN-GND (approx. 2.5 V).
- With an oscilloscope: check the output signals on CAN-H and CAN-L at the S300/S700. Are signals being transmitted on the bus? The voltage difference between CAN-H and CAN-L for a logical "0" is approx. 2-3 V.
- Does signal transmission stop if the master is connected?
- Check the master hardware.
- Check the master software!

6.3.2 Example: Operating the Status Machine

NOTE

The status machine must be used sequentially during boot-up period. Leaving out a status is not possible.

When the S300/S700 is switched on and the boot-up message has been detected, communication via SDOs can be initiated. For example: all the parameters can be read out or written to, or the status machine for the drive can be controlled.

The state of the status machine can be obtained through the query of Object 6041 Sub 0.

Directly after switch-on, a value will be returned, such as 0240h. This corresponds to the status "Switch on disabled".

The following data would then be visible on the CAN bus:

COB-ID	Control byte	Index		Subindex	Data	Comment
		Low byte	High byte			
603	40	41	60	00h	40 00 00 00	
583	4B	41	60	00h	40 02 00 00	
	2 bytes of data				status	

If the supply power is present and the hardware enable is at the High level (24 V to DGND) then you can try to switch the drive to the state "Switched on" by writing the Controlword (Object 6040 Sub 0). If this is successful, there will be a positive acknowledgement in the SDO reply (control byte 0 in the data field = 60h).

Switch on

The messages then appear as follows:

COB-ID	Control byte	Index		Subindex	Data	Comment
		Low byte	High byte			
603	2B	40	60	00h	06 00 00 00	Shut down
583	60	40	60	00h	00 00 00 00	
603	2B	40	60	00h	07 00 00 00	Switch on
583	60	40	60	00h	00 00 00 00	

control word = 0x0007:

Bit 0, Bit 1, Bit 2 set => Switch On, Disable Voltage off, Quick Stop off

Status query 2

The new status can then be queried again, and returns the following result:

COB-ID	Control byte	Index		Subindex	Data	Comment
		Low byte	High byte			
603	40	41	60	00h	—	query status
583	4B	41	60	00h	33 02 00 00	

Status = 0x0233:

Bit 0, Bit 1, Bit 5 set => ready to Switch On, Bit 9 set => RS232 remote operation possible

6.3.3 Example: Jog Mode via SDO

The motor shall work with constant velocity.

COB-ID	Control byte	Index		Sub-index	Data	Comment
		Low byte	High byte			
603	2F	60	60	00h	03 00 00 00	Mode of operation "Profile Velocity"
583	60	60	60	00h	00 00 00 00	
603	23	FF	60	00h	00 00 00 00	setpoint=0
583	60	FF	60	00h	00 00 00 00	
603	2B	40	60	00h	06 00 00 00	shutdown
583	60	40	60	00h	00 00 00 00	
603	2B	40	60	00h	07 00 00 00	switch on
583	60	40	60	00h	00 00 00 00	
603	2B	40	60	00h	0F 00 00 00	enable operation
583	60	40	60	00h	00 00 00 00	
603	23	FF	60	00h	00 41 00 00	setpoint=16640dec / PGEARI=Turns/s for PGEARI=10000, setpoint=1.664 s ⁻¹ 99.84 rpm
583	60	FF	60	00h	00 00 00 00	
603	2B	40	60	00h	0F 01 00 00	Intermediate Stop
583	60	40	60	00h	00 00 00 00	

6.3.4 Example: Torque Mode via SDO

The motor shall work with constant torque. In this mode it is useful to limit the maximum speed with the parameter ICMDVLIM with the terminal function of the setup software.

Example:

ICMDVLIM 300 (= limit of max. speed to 300 rpm)

SAVE

COLDSTART

CAN data:

COB-ID	Control byte	Index		Sub-index	Data	Comment
		Low byte	High byte			
603	2F	60	60	00h	04 00 00 00	Mode of operation "Torque"
583	60	60	60	00h	00 00 00 00	
603	2B	71	60	00h	00 00 00 00	setpoint=0
583	60	71	60	00h	00 00 00 00	
603	2B	40	60	00h	06 00 00 00	shutdown
583	60	40	60	00h	00 00 00 00	
603	2B	40	60	00h	07 00 00 00	switch on
583	60	40	60	00h	00 00 00 00	
603	2B	40	60	00h	0F 00 00 00	enable operation
583	60	40	60	00h	00 00 00 00	
603	2B	71	60	00h	90 01 00 00	setpoint 400 mA
583	60	71	60	00h	00 00 00 00	
603	2B	40	60	00h	0F 01 00 00	intermediate Stop
583	60	40	60	00h	00 00 00 00	

6.3.5 Example: Jog Mode via PDO

It is useful to disable unused PDOs. In Operation Mode "Digital Velocity" a digital speed setpoint is transmitted via RXPDO. Actual position and speed are read via a TXPDO triggered by SYNC.

COB-ID	Control byte	Index		Sub-index	Data	Comment
		Low	High			
603	2F	60	60	00h	03 00 00 00	mode of operation "Profile Velocity"
583	60	60	60	00h	00 00 00 00	
603	2F	00	16	00h	00 00 00 00	delete entries for the first RXPDO
583	60	00	16	00h	00 00 00 00	
603	23	00	16	01h	20 00 FF 60	mapping RXPDO1, Object 60FF, Sub-Index 0 speed setpoint, data length 32bit
583	60	00	16	01h	00 00 00 00	
603	2F	00	16	00h	01 00 00 00	confirm number of mapped objects
583	60	00	16	00h	00 00 00 00	
603	2F	00	1A	00h	00 00 00 00	delete entries for the first TXPDO
583	60	00	1A	00h	00 00 00 00	
603	23	00	1A	01h	20 00 64 60	mapping TXPDO1/1, Object 6064, Sub-Index 0 current position value in SI units, data length 32bit
583	60	00	1A	01h	00 00 00 00	
603	23	00	1A	02h	20 00 6C 60	mapping TXPDO1/2, Object 606C, Sub-Index 0 current speed value, data length 32bit
583	60	00	1A	02h	00 00 00 00	
603	2F	00	1A	00h	02 00 00 00	check number of mapped objects
583	60	00	1A	00h	00 00 00 00	
603	2F	00	18	02h	01 00 00 00	set TXPDO1 to synchronous, transmission with every SYNC
583	60	00	18	02h	00 00 00 00	
603	23	01	18	01h	83 02 00 C0	disable TPDO2, set bit 31 (80h)
583	60	01	18	01h	00 00 00 00	
603	23	02	18	01h	83 03 00 C0	disable TPDO3
583	60	02	18	01h	00 00 00 00	
603	23	03	18	01h	83 04 00 C0	disabled TPDO4
583	60	03	18	01h	00 00 00 00	
603	23	01	14	01h	03 03 00 80	disabled RPDO2
583	60	01	14	01h	00 00 00 00	
603	23	02	14	01h	03 04 00 80	disabled RPDO3
583	60	02	14	01h	00 00 00 00	
603	23	03	14	01h	03 05 00 80	disabled RPDO4
583	60	03	14	01h	00 00 00 00	
000					01 03	enable NMT
603	2B	40	60	00h	06 00 00 00	shutdown
583	60	40	60	00h	00 00 00 00	
603	2B	40	60	00h	07 00 00 00	switch on
583	60	40	60	00h	00 00 00 00	
603	2B	40	60	00h	0F 00 00 00	enable operation
583	60	40	60	00h	00 00 00 00	
203					00 40	setpoint V= 98.3 rpm Calculation: 4000h=16384dec=Ncmd; 10000=PGEAR1; (Ncmd/60)xPGEAR1=V=98.3 rpm
080						send SYNC
183					FE 45 01 00 A6 AB 1A 00	response, position and Nact Pos.= 00 01 45 FE = 83454 [Si units]; Nact = (001A AB A6) / 17894.4dec = 97.7 rpm, 17894.4 is the const. factor.
603	2B	40	60	00h	0F 01 00 00	intermediate stop
583	60	40	60	00h	00 00 00 00	

6.3.6 Example: Torque Mode via PDO

It is useful to disable unused PDOs. The first TX_PDO shall transmit the actual current value with every SYNC.

COB-ID	Control byte	Index		Sub-index	Data	Comment
		Low byte	High byte			
603	2F	60	60	00h	04 00 00 00	Mode of operation "Torque"
583	60	60	60	00h	00 00 00 00	
603	2F	00	16	00h	00 00 00 00	delete entry for the first RXPDO
583	60	00	16	00h	00 00 00 00	
603	23	00	16	01h	10 00 71 60	mapping RXPDO1, Object6071, Sub-Index 0 current setpoint, data length 16bit
583	60	00	16	01h	00 00 00 00	
603	2F	00	16	00h	01 00 00 00	check number of mapped objects
583	60	00	16	00h	00 00 00 00	
603	2F	00	1A	00h	00 00 00 00	delete entry for TXPDO1
583	60	00	1A	00h	00 00 00 00	
603	23	00	1A	01h	10 00 77 60	mapping TXPDO1, Object6077, Sub-Index 0 actual current value, Data length 16bit
583	60	00	1A	01h	00 00 00 00	
603	2F	00	1A	00h	01 00 00 00	number of mapped objects
583	60	00	1A	00h	00 00 00 00	
603	2F	00	18	02h	01 00 00 00	set TXPDO1 to synchronous, transmission with every SYNC
583	60	00	18	02h	00 00 00 00	
603	23	01	18	01h	83 02 00 C0	disable TPDO2, set bit 31 (80h)
583	60	01	18	01h	00 00 00 00	
603	23	02	18	01h	83 03 00 C0	disable TPDO3
583	60	02	18	01h	00 00 00 00	
603	23	03	18	01h	83 04 00 C0	disabled TPDO4
583	60	03	18	01h	00 00 00 00	
603	23	01	14	01h	03 03 00 80	disabled RPDO2
583	60	01	14	01h	00 00 00 00	
603	23	02	14	01h	03 04 00 80	disabled RPDO3
583	60	02	14	01h	00 00 00 00	
603	23	03	14	01h	03 05 00 80	disabled RPDO4
583	60	03	14	01h	00 00 00 00	
000					01 03	enable NMT
603	2B	40	60	00h	06 00 00 00	shutdown
583	60	40	60	00h	00 00 00 00	
603	2B	40	60	00h	07 00 00 00	switch on
583	60	40	60	00h	00 00 00 00	
603	2B	40	60	00h	0F 00 00 00	enable operation
583	60	40	60	00h	00 00 00 00	
203					12 02	setpoint 530 mA
080						send SYNC
183					19 02	actual value 537 mA
603	2B	40	60	00h	0F 01 00 00	intermediate stop
583	60	40	60	00h	00 00 00 00	

6.3.7 Example: Homing via SDO

When the S300/S700 is operated as a linear axis, a homing point must be defined before positioning tasks can be executed. This must be done by executing a homing run in the Homing mode (0x6).

This example shows the procedure in the Homing mode. Some of the parameters that affect the homing movement are set via the bus. If you can ensure that nobody has altered the servoamplifier parameters, then this part can be omitted, since the servoamplifier saves the data in non-volatile memory. The inputs must be configured as limit switches.

Because the dimension parameters are not finally defined in DS402, you must select these units:

PUNIT = 0 (counts)

VUNIT = 0 (counts/s)

ACCUNIT = 3 (counts/s²)

The basic setup of the servoamplifier must be done with the help of the setup software before starting the homing run. The resolution has been set to 10000 µm/turn in this example.

COB-ID	Control byte	Index		Sub-index	Data	Comment
		Low byte	High byte			
703	00					boot-up message
603	40	41	60	00h	00 00 00 00	read profile status
583	4B	41	60	00h	40 02 00 00	
603	23	99	60	01h	10 27 00 00	vref=10000 counts/s until limit switch is reached
583	60	99	60	01h	00 00 00 00	
603	23	99	60	02h	88 13 00 00	vref=5000 counts/s from limit switch to zero mark
583	60	99	60	02h	00 00 00 00	
603	23	9A	60	00h	10 27 00 00	Decel. and Accel. ramp 1000 counts/s ²
583	60	9A	60	00h	00 00 00 00	
603	23	7C	60	00h	A8 61 00 00	Reference offset 25000 counts
583	60	7C	60	00h	00 00 00 00	

Homing type (6098)

COB-ID	Control byte	Index		Sub-index	Data	Comment
		Low byte	High byte			
603	2F	60	60	00h	06 00 00 00	mode of operation = homing
583	60	60	60	00h	00 00 00 00	
603	40	41	60	00h	00 00 00 00	read profile status, response: 0250h
583	4B	41	60	00h	40 02 00 00	Voltage Enabled
603	2B	40	60	00h	06 00 00 00	Controlword Transition_2,"ready to switch on". Shutdown
583	60	40	60	00h	00 00 00 00	
603	2B	40	60	00h	07 00 00 00	Transition_3, "switch on". switch on
583	60	40	60	00h	00 00 00 00	
603	2B	40	60	00h	0F 00 00 00	Transition_4,"operation enable"
583	60	40	60	00h	00 00 00 00	
603	40	41	60	00h	00 00 00 00	read profile status
583	4B	41	60	00h	37 02 00 00	
603	2B	40	60	00h	1F 00 00 00	Homing_operation_start
583	60	40	60	00h	00 00 00 00	
603	40	41	60	00h	00 00 00 00	read profile status, response: homing not finished
583	4B	41	60	00h	37 02 00 00	
603	40	41	60	00h	00 00 00 00	read profile status, response: homing finished
583	4B	41	60	00h	37 16 00 00	

Bit 12 in SDO 6041 indicates, whether homing is finished. Reading of the profile status isn't necessary.

6.3.8 Example: Start Motion Task from the internal memory of S300/S700 via SDO

This example needs a defined motion task (can be done with the setup software) saved in the servoamplifier and homing must be done before starting absolute motion tasks.

COB-ID	Control byte	Index		Sub-index	Data	Comment
		Low byte	High byte			
603	2F	60	60	00h	01 00 00 00	mode of operation= position
583	60	60	60	00h	00 00 00 00	
603	2B	40	60	00h	06 00 00 00	Shutdown
583	60	40	60	00h	00 00 00 00	
603	2B	40	60	00h	07 00 00 00	Switch On
583	60	40	60	00h	00 00 00 00	
603	2B	40	60	00h	0F 00 00 00	Enable Operation
583	60	40	60	00h	00 00 00 00	
603	2B	80	20	00h	03 00 00 00	Select motion task 3
583	60	80	20	00h	00 00 00 00	
603	2B	40	60	00h	3F 00 00 00	Start with new SETPOINT and CHANGE_SET_IMMEDIATELY
583	60	40	60	00h	00 00 00 00	
603	40	81	20	00h	00 00 00 00	Read active motion task. response: Motion task 3 in operation
583	4B	81	20	00h	03 00 00 00	

6.3.9 Example: Using the Profile Position Mode

This example shows the operation of the Profile position mode. For this, the PDOs are set as follows:

First RPDO

No special mapping necessary, because the default mapping enters the controlword RXPDO1.

Second RPDO

COB-ID	Control byte	Index		Sub-index	Data	Comment
		Low byte	High byte			
603	2F	01	16	00h	00 00 00 00	RPDO2: delete mapping
583	60	01	16	00h	00 00 00 00	
603	23	01	16	01h	20 00 7A 60	RPDO2, entry 1: target_position
583	60	01	16	01h	00 00 00 00	
603	23	01	16	02h	20 00 81 60	RPDO2, entry 2: profile_velocity
583	60	01	16	02h	00 00 00 00	
603	2F	01	16	00h	02 00 00 00	enter number of mapped objects
583	60	01	16	00h	00 00 00 00	

First TPDO

COB-ID	Control byte	Index		Sub-index	Data	Comment
		Low byte	High byte			
603	2F	00	1A	00h	00 00 00 00	TPDO1: delete mapping
583	60	00	1A	00h	00 00 00 00	
603	23	00	1A	01h	10 00 41 60	TPDO1, entry 1: profile statusword
583	60	00	1A	01h	00 00 00 00	
603	2F	00	1A	00h	01 00 00 00	enter number of mapped objects
583	60	00	1A	00h	00 00 00 00	

Second TPDO

COB-ID	Control byte	Index		Sub-index	Data	Comment
		Low byte	High byte			
603	2F	01	1A	00h	00 00 00 00	TPDO2: delete mapping
583	60	01	1A	00h	00 00 00 00	
603	23	01	1A	01h	20 00 64 60	TPDO2, entry 1: position_actual_value
583	60	01	1A	01h	00 00 00 00	
603	23	01	1A	02h	20 00 6C 60	TPDO2, entry 2: velocity_actual_value
583	60	01	1A	02h	00 00 00 00	
603	2F	01	1A	00h	02 00 00 00	enter number of mapped objects
583	60	01	1A	00h	00 00 00 00	

The second TPDO should be sent with every SYNC by the servoamplifier.

COB-ID	Control byte	Index		Sub-index	Data	Comment
		Low byte	High byte			
603	2F	01	18	02h	01 00 00 00	TPDO2 with every SYNC
583	60	01	18	02h	00 00 00 00	

Disable unused TPDOs

COB-ID	Control byte	Index		Sub-index	Data	Comment
		Low byte	High byte			
603	23	02	18	01h	83 03 00 C0	disable TPDO3
583	60	02	18	01h	00 00 00 00	
603	23	03	18	01h	83 04 00 C0	disable TPDO4
583	60	03	18	01h	00 00 00 00	

Disable unused RPDOs

COB-ID	Control byte	Index		Sub-index	Data	Comment
		Low byte	High byte			
603	23	02	14	01h	03 04 00 80	disable RPDO3
583	60	02	14	01h	00 00 00 00	
603	23	03	14	01h	03 05 00 80	disable RPDO4
583	60	03	14	01h	00 00 00 00	

Define mechanical resolution via Object 6092h, Sub-Index 01h and 02h. Default values are the motion specific factors PGEARI and PGEARO:

COB-ID	Control byte	Index		Sub-index	Data	Comment
		Low byte	High byte			
603	23	93	60	01h	00 00 10 00	2E20 increments
583	60	93	60	01h	00 00 00 00	
603	23	93	60	02h	A0 8C 00 00	3600 user units
583	60	93	60	02h	00 00 00 00	

After defining the PDOs they can be released with the NMT:

COB-ID	Data	Comment
000	01 03	enable NMT
183	40 02	profile status

Now the homing can be set and started.

COB-ID	Control byte	Index		Sub-index	Data	Comment
		Low byte	High byte			
603	2F	60	60	00h	06 00 00 00	Operation mode = homing
583	60	60	60	00h	00 00 00 00	
603	2F	98	60	00h	0C 00 00 00	homing type 12, negative direction (DS402)
583	60	98	60	00h	00 00 00 00	
603	23	99	60	01h	40 19 01 00	homing speed 72000 units/s = 2s-1
583	80	99	60	01h	31 00 09 06	
603	2B	40	60	00h	06 00 00 00	Transition_2,"ready to switch on". Shutdown
583	60	40	60	00h	00 00 00 00	
183					21 02	
603	2B	40	60	00h	07 00 00 00	Transition_3,"switch on". Switch on
583	60	40	60	00h	00 00 00 00	
183					33 02	
603	2B	40	60	00h	0F 00 00 00	Controlword: Operation Enable
583	60	40	60	00h	00 00 00 00	
183					37 02	
603	2B	40	60	00h	1F 00 00 00	start homing
583	60	40	60	00h	00 00 00 00	response telegram
183					37 06	response: target reached
183					37 16	response: homing attained

Finish homing with Controlword 1_RPDO

COB-ID	Data	Comment
203	0F 00	

Switch to Profile Position Mode and set ramps for positioning

COB-ID	Control byte	Index		Sub-index	Data	Comment
		Low byte	High byte			
603	2F	60	60	00h	01 00 00 00	Profile Positioning Mode
583	60	60	60	00h	00 00 00 00	
603	23	83	60	00h	32 00 00 00	50ms acceleration time
583	60	83	60	00h	00 00 00 00	
603	23	84	60	00h	32 00 00 00	50ms deceleration time
583	60	84	60	00h	00 00 00 00	

Setpoint

COB-ID	Data	Comment
303	20 4E 00 00	Pos 8CA0 =36000µm ; V= 20000 µm/s
080		send a SYNC
283	BB F8 FF FF	

Set controlword with „new setpoint“ by bit (bit 4)

COB-ID	Data	Comment
203	1F 00	

Wait

COB-ID	Data	Comment
183	37 12	setpoint acknowledge

Reset controlword with „new setpoint“ by bit (bit 4) reset

COB-ID	Data	Comment
203	0F 00	
183	37 02	reset Setpoint acknowledge

Wait

COB-ID	Data	Comment
183	37 06	response: target reached
080		SYNC
283	92 FC FF FF	response: 92 FC position FF FF speed

6.3.10 Example: ASCII Communication via SDO

This example sets P gain of the velocity controller to 6. The ASCII command for this is "GV 6".

COB-ID	Control byte	Index		Sub-index	Data	Comment
		Low byte	High byte			
603	2F	26	10	01h	47 00 00 00	send ASCII code "G"
583	60	26	10	01h	00 00 00 00	
603	2F	26	10	01h	56 00 00 00	send ASCII code "V"
583	60	26	10	01h	00 00 00 00	
603	2F	26	10	01h	20 00 00 00	send ASCII code "SP" (space)
583	60	26	10	01h	00 00 00 00	
603	2F	26	10	01h	36 00 00 00	send ASCII code "6"
583	60	26	10	01h	00 00 00 00	
603	2F	26	10	01h	0D 00 00 00	send ASCII code "CR"
583	60	26	10	01h	00 00 00 00	
603	2F	26	10	01h	0A 00 00 00	send ASCII code "LF"
583	60	26	10	01h	00 00 00 00	

6.3.11 Test for SYNC telegrams

Configuration

Targets:

- Assign Target Position and Profile Velocity to a PDO (2nd receive-PDO)
- Assign Actual Position to a PDO (1st transmit-PDO), generated with every 2nd SYNC.
- Assign Statusword and Manufacturer Status to a PDO (2nd transmit-PDO), generated with every 3rd SYNC.

Telegrams with the corresponding responses:

COB-ID	Control byte	Index		Sub-index	Data	Comment
		Low	High			
603	2F	01	16	00h	00 00 00 00	RPDO2: delete mapping
583	60	01	16	00h	00 00 00 00	
603	23	01	16	01h	20 00 7A 60	RPDO2, entry 1: target position
583	60	01	16	01h	00 00 00 00	
603	23	01	16	02h	20 00 81 60	RPDO2, entry 2: profile velocity
583	60	01	16	02h	00 00 00 00	
603	2F	01	16	00h	02 00 00 00	RPDO2: enter number of mapped objects
583	60	01	16	00h	00 00 00 00	
603	2F	00	1A	00h	00 00 00 00	TPDO1: delete mapping
583	60	00	1A	00h	00 00 00 00	
603	23	00	1A	01h	20 00 64 60	TPDO1: entry 1: Actual Position
583	60	00	1A	01h	00 00 00 00	
603	2F	00	1A	00h	01 00 00 00	TPDO1: enter number of mapped objects
583	60	00	1A	00h	00 00 00 00	
603	2F	00	18	02h	02 00 00 00	TPDO1: send with every 2nd SYNC
583	60	00	18	02h	00 00 00 00	
603	2F	01	1A	00h	00 00 00 00	TPDO2: delete mapping
583	60	01	1A	00h	00 00 00 00	
603	23	01	1A	01h	10 00 41 60	TPDO2: entry 1: Statusword
583	60	01	1A	01h	00 00 00 00	
603	23	01	1A	02h	20 00 02 10	TPDO2: entry 2: Manufacturer Status
583	60	01	1A	02h	00 00 00 00	
603	2F	01	16	00h	02 00 00 00	TPDO2: enter number of mapped objects
583	60	01	16	00h	00 00 00 00	
603	2F	01	18	02h	03 00 00 00	TPDO2: send with every 3rd SYNC
583	60	01	18	02h	00 00 00 00	

SYNC-Object

COB-ID	Comment
080	Object 181 (TPDO 1) appears at every 2nd SYNC, Object 281 (TPDO 2) appears at every 3rd SYNC.

Emergency-Object

If, for instance, the resolver connector is disconnected, a serious error will be caused in the controller. This results in an emergency telegram.

COB-ID	Emergency error		Error register	Data	Comment
	Low	High			
081	10	43	08	00 00 00 00	motor temperature, temperature,
081	00	00	88	00 00 00 00	manufacturer specific

6.3.12 Application: Electric Gearing

When using the electric gearing mode via the CANopen interface, the following parameters are relevant for setting the slave of the electric gearing:

GEARI	Object 2040 sub 1
GEARO	Object 2040 sub 2
GEARMODE	Object 353F sub 1
EXTPOS	Object 3539 sub 1
IN20MODE	Object 3723 sub 1
IN20TRIG	Object 3724 sub 1 or Object 20B0 sub 0 (also mappable)
ACCR	Object 3502 sub 1
DECR	Object 3524 sub 1

ACCR and DECR can also be set together via object 609A (also mappable).

The transmission of the electric gearing is set using gear factors GEARI and GEARO. The input of the master impulse is defined using the parameters GEARMODE and EXTPOS.

The following bits have special meaning in the electrical gearing operating mode:

CANopen status word Bit 10 = 1: Slave axis is synchronised

CANopen control word Bit 13 = 1: Stop synchronised movement of the slave axis

The virtual input 20 can be used to change the type of synchronisation/de-synchronisation with the master for the following input functions (IN20MODE):

- IN20MODE 42:** Slave axis synchronisation is enabled using the ramp ACCR and disabled using DECR.
- IN20MODE 43:** When the slave axis is started, the master position is latched. The slave axis is then brought up to master speed via the ramp ACCR and the travel distance to the master is subsequently adjusted. Synchronisation is deactivated via DECR. Using IN20TRIG, a position offset to the master position can also be assigned.
- IN20MODE 51:** IN20TRIG can be used to specify a travel distance to which the slave should be synchronised. Synchronisation is deactivated via DECR.

6.3.13 Application: External Trajectory with Interpolated Position Mode

This example shows the possible application for giving two axes position setpoints within one PDO.

Controller structure for the position controller within the servo amplifier:

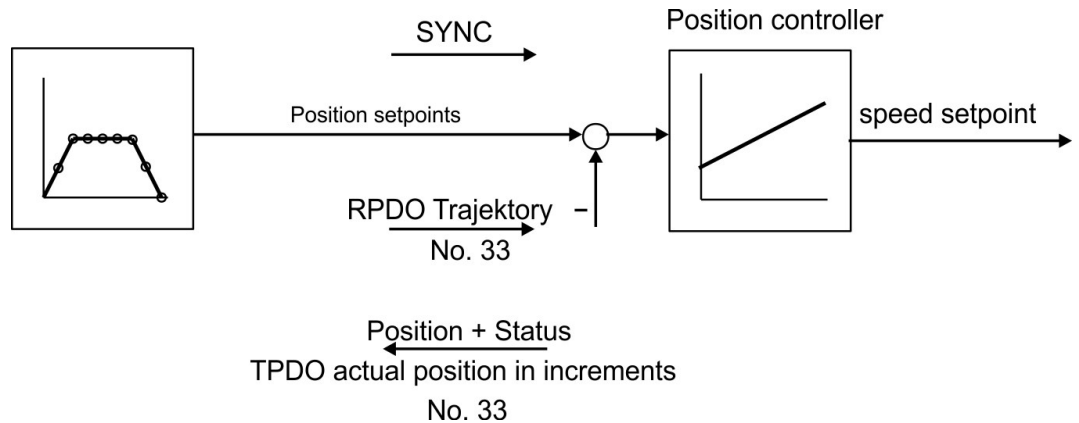

Description

All data are hexadecimal. In the example, the two axes in the system have the station addresses 1 and 2.

Prerequisites

- The internal synchronisation must be used for the IP-mode.
For that purpose the parameter SYNC SRC (Object 3683 sub 1) must be set to 3.
- The parameters must be saved to EEPROM.
- A coldstart has to be done to enable the synchronisation possibility.
- The axes are homed (for this example).

The common PDO contains 2 IP (interpolated position) – setpoints and can be transmitted simultaneously to two stations, whereby each station can extract the relevant data. The other data can be made ignored by using dummy entries (Object 2100 sub 0). For this purpose both axes have to react on the same RPDO-COB-ID.

Action

Do the RPDO2-mapping for both axis:

Axis 1:

COB-ID	Control byte	Index		Sub-index	Data	Comment
		Low byte	High byte			
601	2F	01	16	00h	00 00 00 00	RPDO2: delete mapping
581	60	01	16	00h	00 00 00 00	
601	23	01	16	01h	20 01 C1 60	RPDO2, entry 1: IP setpoint axis 1
581	60	01	16	01h	00 00 00 00	
601	23	01	16	02h	20 00 00 21	RPDO2, entry 2: Dummy entry 4 bytes
581	60	01	16	02h	00 00 00 00	
601	2F	01	16	00h	02 00 00 00	RPDO2, enter number of mapped objects
581	60	01	16	00h	00 00 00 00	

Axis 2:

COB-ID	Control byte	Index		Sub-index	Data	Comment
		Low byte	High byte			
602	2F	01	16	00h	00 00 00 00	RPDO2: delete mapping
582	60	01	16	00h	00 00 00 00	
602	23	01	16	01h	20 00 00 21	RPDO2, entry 1: Dummy entry 4 bytes
582	60	01	16	01h	00 00 00 00	
602	23	01	16	02h	20 01 C1 60	RPDO2, entry 2: IP setpoint axis 2
582	60	01	16	02h	00 00 00 00	
602	2F	01	16	00h	02 00 00 00	RPDO2, enter number of mapped objects
582	60	01	16	00h	00 00 00 00	
602	23	01	14	01h	01 03 00 00	RPDO2: Set COB-ID identical to axis 1
582	60	01	14	01h	00 00 00 00	

Now both axis react to the same COB-identifier 0x301, axis 1 takes byte 0 to 3 as IP setpoint, axis 2 takes byte 4 to 7.

The second TPDOs shall contain the actual position in increments and the manufacturer status.

Mapping configuration for axis 1:

COB-ID	Control byte	Index		Sub-index	Data	Comment
		Low byte	High byte			
601	2F	01	1A	00h	00 00 00 00	TPDO2: delete mapping
581	60	01	1A	00h	00 00 00 00	
601	23	01	1A	01h	20 00 63 60	TPDO2, entry 1: actual position in increments
581	60	01	1A	01h	00 00 00 00	
601	23	01	1A	02h	20 00 02 10	TPDO2, entry 2: Dummy entry 4 bytes
581	60	01	1A	02h	00 00 00 00	
601	2F	01	1A	00h	02 00 00 00	TPDO2, enter number of mapped objects
581	60	01	1A	00h	00 00 00 00	

The same has to be done for axis 2.

Here it is assumed that both drives accept new trajectory values with every SYNC command, and have to return their incremental position and manufacturer status values. The communication parameters must be set accordingly.

Axis 1:

COB-ID	Control byte	Index		Sub-index	Data	Comment
		Low byte	High byte			
601	2F	01	14	02h	01 00 00 00	RPDO2 axis 1, reaction on every sync
581	60	01	14	02h	00 00 00 00	
602	2F	01	14	02h	01 00 00 00	RPDO2 axis 2, reaction on every sync
582	60	01	14	02h	00 00 00 00	
601	2F	01	18	02h	01 00 00 00	TPDO2 axis 1, reaction on every sync
581	60	01	18	02h	00 00 00 00	
602	2F	01	18	02h	01 00 00 00	TPDO2 axis 2, reaction on every sync
582	60	01	18	02h	00 00 00 00	

The other Tx-PDOs 3 and 4 should be switched off to minimize bus-load:

COB-ID	Control byte	Index		Sub-index	Data	Comment
		Low byte	High byte			
601	23	02	18	01h	81 03 00 C0	Switch off TPDO3
581	60	02	18	01h	00 00 00 00	
601	23	03	18	01h	81 04 00 C0	Switch off TPDO4
581	60	03	18	01h	00 00 00 00	

The same has to be done for axis 2.

In order to be able to make trajectory movements, both servo amplifiers must be operating in the appropriate mode. This is set through Index 6060h:

COB-ID	Control byte	Index		Sub-index	Data	Comment
		Low byte	High byte			
601	2F	60	60	00h	07 00 00 00	Set IP mode for axis 1
581	60	60	60	00h	00 00 00 00	
602	2F	60	60	00h	07 00 00 00	Set IP mode for axis 2
582	60	60	60	00h	00 00 00 00	

The cycle interval for the IP-mode shall be 1 ms. This has to be defined with Object 60C1 sub 1 and 2:

COB-ID	Control byte	Index		Sub-index	Data	Comment
		Low byte	High byte			
601	2F	C2	60	01h	01 00 00 00	Interpolation time unit 1
581	60	C2	60	01h	00 00 00 00	
601	2F	C2	60	02h	FD 00 00 00	Interpolation time index -3
581	60	C2	60	02h	00 00 00 00	=> Cycle time = 1 * 10 ⁻³ s

The same need to be done for axis 2.

To start up the axes, the servo amplifiers must be put into the operational status (operation enable) and the network management functions must be started.

The network management functions enable the application of the Process Data Objects (PDOs) and are initialized by the following telegram for both axes:

Switch the NMT (Network Management) status machine to operation enable:

COB-ID	Command specifier (CS)	Node-ID	Comment
0	1	1	NMT enable for all axes

Next, power is applied to each servo amplifier, and they are put into the operation enable condition. This should be done in steps with waiting for the appropriate reaction of the drive (example axis 1):

COB-ID	Data	Comment
201	06 00	Shutdown command
181	31 02	State Ready_to_switch_on
201	07 00	Switch_on command
181	33 02	State Switched_on
201	0F 00	Enable_operation command
181	37 02	State Operation_enabled
201	1F 00	Enable IP-mode
181	37 12	IP-mode enable

The configuration above now enables a cyclical sequence, as shown in the diagram:

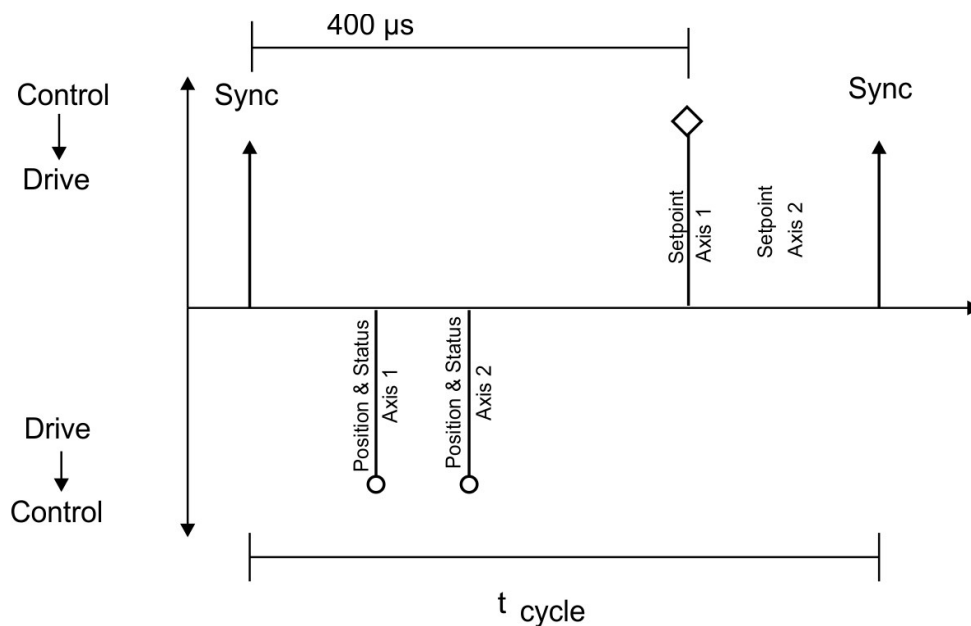

e.g. 2 axes

t_{cycle} 1 ms per axis at 1 MBaud

RPDO 2 can now be used to supply trajectory data for both axes, e.g.:

COB-ID	Byte 0	Byte 1	Byte 2	Byte 3	Byte 4	Byte 5	Byte 6	Byte 7
301	F4	01	00	00	E8	03	00	00

In this example, the first axis receives a trajectory value of 500 increments (Bytes 0 ... 3) and the second axis receives a trajectory value of 1000 increments.

The axes accept these values, and the positioning is made when the next SYNC telegram is received.

SYNC telegram

COB-ID
301

Afterwards, both axes send back their incremental positions and the contents of their status registers when the SYNC Object with the COB-ID for the 2nd TPDO is received:

COB-ID	Byte 0	Byte 1	Byte 2	Byte 3	Byte 4	Byte 5	Byte 6	Byte 7	Comment
181	23	01	00	00	00	00	03	44	position + manufacturer status register for axis1
182	A5	02	00	00	00	00	03	44	position + manufacturer status register for axis2

If an error occurs during operation, the axis concerned transmits an Emergency message, which could appear like this:

Emergency Object

COB-ID	Emergency error		Error register	Category		
	Low	High				
081	10	43	08	01	00 00 00 00	motor temperature, temperature, manufacturer-specific
081	00	00	08	00	00 00 00 00	

--- / ---

7 Index

1

1000h	29
1001h	29
1002h	30
1003h	31
1005h	32
1006h	32
1008h	32
1009h	33
100Ah	33
100Ch	33
100Dh	33
1010h	34
1011h	35
1014h	35
1016h	36
1017h	36
1018h	37
1026h	38
1400-1403h	52
1600-1603h	53
1800-1803h	54
1A00-1A03h	56

2

2000h	39
2014-2017h	40
2030h	40
2040h	41
2041h	42
2051h	43
2052h	44
2053h	44
2061h	45
2080h	45
2081h	45
2082h	46
2083h	46
2090h	46
20A0h	47
20A1h	47
20A2h	47
20A3h	48
20A4h	48
20B0h	48
20B1h	49
20B2h	49
2100h	50
2101h	50
2400h	111
2401h	111
2402h	112
2403h	113
2404h	114
2405h	114
2406h	115
2407h	115
2408h	116
2409h	116

240Ah	117
240Bh	117
240Ch	118

3

3500h to 39xxh	93
----------------	----

6

6040h	59
6041h	61
6060h	62
6061h	63
6063h	75
6064h	76
6065h	76
6067h	76
6068h	77
606Ch	73
6071h	74
6073h	74
6077h	74
607Ah	87
607Ch	83
607Dh	87
607Fh	88
6080h	88
6081h	88
6083h	89
6084h	89
6085h	89
6086h	90
6089h	64
608Ah	64
608Bh	70
608Ch	70
608Dh	71
608Eh	71
608Fh	65
6091h	66
6092h	67
6093h	68
6094h	69
6097h	72
6098h	84
6099h	85
609Ah	85
60C0h	78
60C1h	79
60C2h	80
60C3h	81
60C4h	81
60C5h	90
60F4h	77
60FDh	50
60FFh	73
6502h	51

A

Abbreviations	10
Additional documentation	9
ASCII command reference	95

B

Basic data types	18
Basic features	12

C

Cable	14
Communication Profile	16
Communication faults	12
Communication Objects	19
Configuration parameters	15
Control word	59

D

Data Frame	16
Data types	18
Device control (dc)	57
Drive Profile	28

E

Emergency Messages	28
Emergency Object (EMCY)	20
Examples	118
Examples, special applications	131
Extended data types	19

F

Factor Groups (fg)	63
--------------------------	----

G

General Definitions	29
---------------------------	----

H

Heartbeat	27
Homing Mode (hm)	83

I

Installation	13
Interface	14
Interpolated Position Mode (ip)	78

M

Mapping	51
Mixed data types	18

N

Network Management Objects (NMT)	20
Nodeguard	26

O

Object Channel	93
Object Dictionary	104
Operating mode	62

P

PDO Configuration	51
Position Control Function (pc)	75
Process Data Object (PDO)	24
Profile Position Mode (pp)	86
Profile Torque Mode (tq)	74
Profile Velocity Mode (pv)	73

R

Receive PDOs (RXPDO)	52
Remote Frame	16
Response monitoring	33

S

SDO Abort Codes	24
Service Data Objects (SDO)	22
Setup	13
station address	13
Status Machine	57
Status word	61
Symbols used	10
Synchronization Object (SYNC)	20

T

Target group	9
TIME	20
Time-Stamp Object	20
Transmission modes	25
Transmission procedure	12
Transmission rate	13
Transmit PDOs (TXPDO)	54
Trigger modes	25

U

Use as directed	10
-----------------------	----

--/--

Service

We are committed to quality customer service. In order to serve in the most effective way, please contact your local sales representative for assistance.

If you are unaware of your local sales representative, please contact the Customer Support.



Join the [Kollmorgen Developer Network](#) for product support. Ask the community questions, search the knowledge base for answers, get downloads, and suggest improvements.



Europe

KOLLMORGEN

Internet: www.kollmorgen.com/en-us

E-Mail: technik@kollmorgen.com

Tel.: +49 - 2102 - 9394 - 0

Fax: +49 - 2102 - 9394 - 3155



North America

KOLLMORGEN

Internet: www.kollmorgen.com/en-us

E-Mail: support@kollmorgen.com

Tel.: +1 - 540 - 633 - 3545

Fax: +1 - 540 - 639 - 4162



South America

KOLLMORGEN

Internet: www.kollmorgen.com/pt-br

E-Mail: contato@kollmorgen.com

Tel.: +55 - 11 - 4615-6300



Asia

KOLLMORGEN

Internet: www.kollmorgen.cn

E-Mail: sales.china@kollmorgen.com

Tel: +86 - 400 668 2802

Fax: +86 - 21 6248 5367

