

# PROFINET

## Fieldbus Interface for S300 / S700



Edition: October 2022

Translation of the original manual



For safe and proper use,  
follow these instructions.  
Keep them for future  
reference.

### Previous editions

Revision	Remarks
04 / 2020	First edition
10 / 2022	Formula in chapter "digital speed" corrected, addition in chapter "analog speed"

### Trademarks

- WINDOWS is a registered trademark of Microsoft Corporation.
- SINEC is a registered trademark of Siemens AG
- PROFIBUS and PROFINET are registered trademarks of PROFIBUS and PROFINET International (PI).

### Technical changes which improve the performance of the device may be made without prior notice!

This document is the intellectual property of Kollmorgen. All rights reserved. No part of this work may be reproduced in any form (by photocopying, microfilm or any other method) or stored, processed, copied or distributed by electronic means without the written permission of Kollmorgen.

# 1 Table of Contents

<b>1 Table of Contents</b>	<b>3</b>
<b>2 General</b>	<b>5</b>
2.1 About this manual	5
2.2 Target group	5
2.3 Using the PDF Format	6
2.4 Use as directed	6
2.5 Symbols Used	6
2.6 Abbreviations used	7
<b>3 Installation / Setup</b>	<b>8</b>
3.1 Mounting, Installation	8
3.1.1 Inserting the Expansion Card (S300 and S700)	9
3.1.1.1 Front view	9
3.1.2 LEDs	9
3.1.3 Device master file	9
3.1.4 Connection technology	9
3.1.5 Pinout	9
3.1.6 Connection examples	10
3.1.7 Standard functions for data exchange with the servo amplifier	10
3.2 Setup	11
3.2.1 Guide to setup	11
3.2.2 Important amplifier configuration parameters	12
3.2.3 Setup Software	15
3.2.3.1 Screen page PROFINET	15
3.2.3.2 Screen page PROFINET Instrument control	16
<b>4 Device profile</b>	<b>17</b>
4.1 Parameter channel	18
4.1.1 Parameter ID (PKE)	18
4.1.1.1 Interpretation of the response IDs	18
4.1.1.2 Response ID 7: Profile specific error numbers	19
4.1.2 Index IND	19
4.1.3 Parameter value PWE	20
4.2 The process data channel (PZD)	20
<b>5 Parameter channel (PKW)</b>	<b>21</b>
5.1 Read/write an amplifier parameter	21
5.2 Summary of the parameter numbers	21
5.2.1 List of the parameters	22
5.2.2 Profile Parameters	24
5.2.2.1 PNU 970: Default parameters	24
5.2.2.2 PNU 971: Non volatile saving of parameters	24
5.2.2.3 PNU 930: Selection Switch for Operating Modes	24
5.2.3 Manufacturer specific parameters	25
5.2.3.1 PNU 1000: Instrument ID	25
5.2.3.2 PNU 1001: Manufacturer specific error register	25
5.2.3.3 PNU 1002: Manufacturer specific status register	26
5.2.4 Position control parameters	27
5.2.4.1 PNU 1894: Velocity multiplier	27
5.2.4.2 PNU 1807: Axis type	27
5.2.5 Position data for the position control mode	27
5.2.5.1 PNU 1790: Position	27
5.2.5.2 PNU 1791: Velocity	27

5.2.5.3 PNU 1785: Motion task type .....	28
5.2.5.4 PNU 1783: Acceleration time .....	28
5.2.5.5 PNU 1786: Deceleration time .....	29
5.2.5.6 PNU 1788: Next motion task .....	29
5.2.5.7 PNU 1789: Start delay .....	29
5.2.5.8 PNU 1310: Copy motion task .....	29
5.2.6 Setup mode Position .....	29
5.2.6.1 PNU 1773: Homing type .....	29
5.2.6.2 PNU 1644: Homing direction .....	29
5.2.7 Actual values .....	29
5.2.7.1 PNU 1800: Actual position value in SI (User) units .....	29
5.2.8 Digital I/O Configuration .....	30
5.2.8.1 PNUs 1698/1701/1704/1707: Digital input configuration .....	30
5.2.8.2 PNUs 1775/1778: Digital output configuration .....	30
5.2.9 Analog configuration .....	30
5.2.9.1 PNU 1607: Analog input configuration .....	30
5.2.10 Manufacturer specific object channel (from PNU 1600) .....	31
<b>6 Process data channel .....</b>	<b>33</b>
6.1 Instrument control .....	34
6.1.1 Control word (STW) .....	36
6.1.2 Status word (ZSW) .....	37
6.2 Operating modes(Opmodes) .....	37
6.2.1 Positioning (Opmode 2) .....	38
6.2.2 Digital speed (Opmode 1) .....	39
6.2.3 Analog speed (Opmode -1) .....	39
6.2.4 Digital torque (Opmode -2) .....	40
6.2.5 Analog torque (Opmode -3) .....	40
6.2.6 Electronic gearing (Opmode -4) .....	40
6.2.7 Trajectory (Opmode -5) .....	40
6.2.8 Digital speed & Servo Pump (Opmode -7) .....	41
6.2.9 ASCII channel (Opmode -16) .....	41
6.2.10 Operating mode after switch-on (Opmode -126) .....	41
<b>7 Appendix .....</b>	<b>42</b>
7.1 Setup examples for all servo amplifier models .....	42
7.1.1 Zero telegram (for initialization) .....	42
7.1.2 Setting the Opmode .....	42
7.1.3 Enable the servo amplifier .....	42
7.1.4 Start jog mode (on positioning opmode) .....	43
7.1.5 Set reference point .....	43
7.1.6 Start homing run .....	43
7.1.7 Start a motion task .....	45
7.1.8 Start a direct motion task .....	45
7.1.9 Polling a warning or error message .....	45
7.1.10 Writing a parameter via parameter channel .....	45
7.1.11 Reading actual values .....	46
7.1.12 Write a parameter via the ASCII channel .....	47
7.2 Index .....	49

## 2 General

### 2.1 About this manual

This manual describes Setup and function range of the PROFINET Software protocol for servo amplifiers SERVOSTAR 300 (S300) and S700.

The -PROFINET- expansion card provides a PROFINET interface for these servo amplifiers. The expansion card and it's mounting is described in the instructions manual.

PROFINET is an open fieldbus standard based on Industrial Ethernet. PROFINET communication is defined in the international standards IEC 61158, IEC 61158-5-10 (Application Layer Service Definition), IEC 61158-6-10 (Application Layer Protocol Specification), IEC 61784-1 Type 10 (Communication Profiles) and IEC 61784-2 (PROFINET IO). Further provisions have been defined in specifications published by the user organisation PROFIBUS & PROFINET International (PI).

The PROFINET expansion card

- is available as an option.
- has a PROFINET interface.
- can be configured using the commissioning software "PASmotion"
- operates with a transmission rate of 100 MBit/s (100Base TX), full and half duplex.
- displays the status and fault indicators for communication with PROFINET.
- complies with the PROFINET-IO-Device (V2.31) functions in accordance with Conformance Class A/B.

The servo amplifier supplies the voltage to the expansion card. The input and output buffer can be monitored in the setup software DriveGUI.

The PROFINET expansion card supports the following functions:

- RT, mixed operation (RT, IRT) possible
- LLDP
- I&M 0, I&M 1-4

#### Additional documents that apply

- Instructions Manuals for S300 respectively S701...724 or S748/772
- Details of how to set the parameters for the servo amplifier are described in the online help for the setup software DriveGUI "DriveGUI" beschrieben.

You will need to be conversant with the information in these documents in order to fully understand this manual.

### 2.2 Target group

This manual addresses personnel with the following qualifications:

<b>Transport:</b>	only by personnel with knowledge of handling electrostatically sensitive components.
<b>Unpacking:</b>	only by electrically qualified personnel.
<b>Installation:</b>	only by electrically qualified personnel.
<b>Setup:</b>	only by qualified personnel with extensive knowledge of electrical engineering and drive technology.
<b>Programming:</b>	Software developers, project-planners, experienced PLC programmers with PROFIBUS DP expertise.

The personnel must observe IEC 60364/60664, and regional accident prevention regulations.

#### Qualified Personnel only!

During operation there are deadly hazards, with the possibility of death, severe injury or material damage.

- The user must ensure that the safety instructions in this manual are followed.
- The user must ensure that all personnel responsible for working with the servo amplifier have read and understood the instructions manual.

Training courses are available on request.

## 2.3 Using the PDF Format

This document includes several features for ease of navigation

<b>Cross References</b>	Table of contents and index include active cross references.
<b>Table of contents and index</b>	Lines are active cross references. Click on the line and the appropriate page is accessed.
<b>Page/chapter numbers in the text</b>	Page/chapter numbers with cross references are active links.

## 2.4 Use as directed

Please observe the chapter "Use as directed" in the instructions manual for the servo amplifier.

The PROFINET interface serves only for the connection of the servo amplifier to a controller with PROFINET connectivity.

The servo amplifiers are components that are built into electrical apparatus or machinery, and can only be setup and operated as integral components of such apparatus or machinery.









We only guarantee the conformity of the servo amplifier with the directives listed in the EU Declaration of Conformity, if the components that we specify are used, and the installation regulations are followed.

The machine manufacturer must produce a hazard analysis for the machine. He must take appropriate measures to ensure that unexpected movements do not lead to hazardous situations for either people or equipment.

### NOTE

The approvals of the respective servo amplifier apply to the use of the PROFINET expansion card in an S300 / S700 (see technical data in the instructions manual for the servo amplifier).

## 2.5 Symbols Used

Symbol	Indication
 <b>DANGER</b>	Indicates a hazardous situation which, if not avoided, will result in death or serious injury.
 <b>WARNING</b>	Indicates a hazardous situation which, if not avoided, could result in death or serious injury.
 <b>CAUTION</b>	Indicates a hazardous situation which, if not avoided, could result in minor or moderate injury.
 <b>NOTICE</b>	Indicates situations which, if not avoided, could result in property damage.
 <b>NOTE</b>	This symbol indicates important notes.
	Warning of a danger (general). The type of danger is specified by the text next to the symbol.
	Warning of danger from electricity and its effects.
	Warning of danger from suspended loads.
	Warning of danger from automatic start.

## 2.6 Abbreviations used

Abbrev.	Meaning
BTB/RTO	Ready to operate
EEPROM	Electrically erasable programmable memory
EN	European standard
IEC	International Electrotechnical Commission
INC	Incremental Interface
LED	Light-emitting diode
MB	Megabyte
NI	Zero pulse
NSTOP	Limit-switch input for CCW rotation (left)
P1	Port 1
P2	Port 2
PNO	PROFIBUS and PROFINET User Organization
PSTOP	Limit-switch input for CW rotation (right)
PZD	Process data
RAM	Volatile memory
PLC	Programmable logic controller
S300	SERVOSTAR 300
SSI	Synchronous serial interface
VAC	AC voltage
V DC	DC voltage

## 3 Installation / Setup

### 3.1 Mounting, Installation



#### **⚠ DANGER** High Voltages up to 900V!

Risk of electric shock. Residual charges in the capacitors can still have dangerous levels several minutes after switching off the supply voltage. Power and control connections can still be live, even though the motor is not rotating.

- Install and wire up the equipment only while it is not electrically connected.
- Make sure that the control cabinet is safely isolated (lock-out, warning signs etc.). The individual supply voltages will not be switched on until setup is carried out.
- Measure the voltage in the intermediate (DC-link) circuit and wait until it has fallen below 50V.



#### **⚠ WARNING** Automatic Start!

Risk of death or serious injury for humans working in the machine. Drives with servo amplifiers in fieldbus systems are remote-controlled machines. They can start to move at any time without previous warning.

- Implement appropriate protective measures to ensure that any unintended start-up of the machines cannot result in dangerous situations for personnel or machinery.
- The user is responsible for ensuring that, in the event of a failure of the servo amplifier, the drive is set to a state that is functional safe, for instance with the aid of a safe mechanical brake.
- Software limit-switches are not a substitute for the hardware limit-switches in the machine.

#### **NOTICE**

Install the servo amplifier as described in the instructions manual. The wiring for the analog set-point input and the positioning interface is not required.

#### **NOTE**

Because of the internal representation of the position-control parameters, the position controller can only be operated if the final limit speed of the drive does not exceed:

#### **rotary**

at sinusoidal<sup>2</sup> commutation: max. 7500 rpm

at trapezoidal commutation: max. 12000 rpm

#### **lineary**

at sinusoidal<sup>2</sup> commutation: max. 4 m/s

at trapezoidal commutation: max. 6,25 m/s

#### **NOTE**

All the data on resolution, step size, positioning accuracy etc. refer to calculatory values. Non-linearities in the mechanism (backlash, flexing, etc.) are not taken into account.

If the final limit speed of the motor has to be altered, then all the parameters that were previously entered for position control and motion blocks must be adapted.



### 3.1.1 Inserting the Expansion Card (S300 and S700)

**NOTE**

1. Remove the cover of the option slot (see installation manual of the servo amplifier.)
2. Take care that no small items (such as screws) fall into the open option slot.
3. Push the expansion card carefully into the guide rails that are provided, without twisting it.
4. Press the expansion card firmly into the slot, until the front cover touches the fixing lugs. This ensures that the connectors make good contact.
5. Use the screws on the expansion card to secure it in the drive.

#### 3.1.1.1 Front view



#### 3.1.2 LEDs

Name	Color	Function
BF	Red	On = Bus error Off = No error Flashing 2Hz = No data is being exchanged
SF	Red	On = System error Off = No error Flashing 2Hz = DCP signal service is initiated via the bus
Power	Green	On = Supply voltage is present Off = No supply voltage
RJ45: Link / Activity	Green	On = Connection to Ethernet Off = No connection to Ethernet
RJ45: Rx/Tx	Yellow	On = Sends / receives Ethernet frames

#### 3.1.3 Device master file

The GSDML file is available from the add-on CDROM or from the Kollmorgen Website.

#### 3.1.4 Connection technology

The PROFIBUS User Organisation PNO describes the cable selection, cable routing, shielding, bus connectors, bus termination and runtimes. The following minimum requirements of the connection cable and connector must be met:

- Only use standard industrial Ethernet cable and connectors.
- Only use double-shielded twisted pair cable and shielded RJ45 connectors (industrial connectors).
- 100BaseTX cable in accordance with the Ethernet standard (min. Category 5)

#### 3.1.5 Pinout

X50/X51, RJ45	Signal	X50/X51, RJ45	Signal
1	TD+ (Transmit+)	5	n.c.
2	TD- (Transmit-)	6	RD- (Receive-)
3	RD+ (Receive+)	7	n.c.
4	n.c.	8	n.c.

### 3.1.6 Connection examples

#### Example in the RT network



#### Example in the RT / IRT network

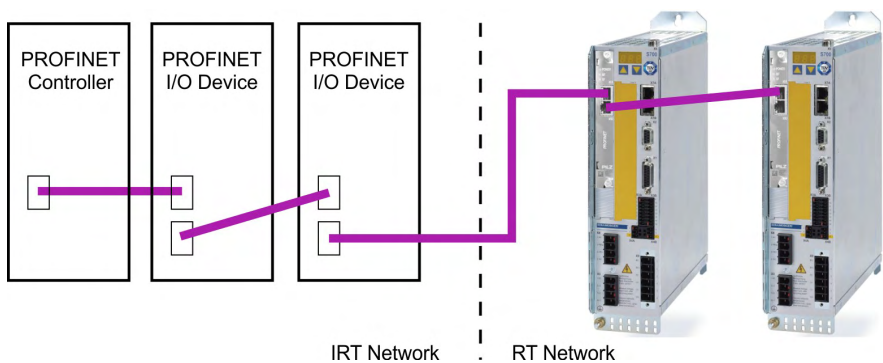

#### Example in the RT / IRT network with Switch

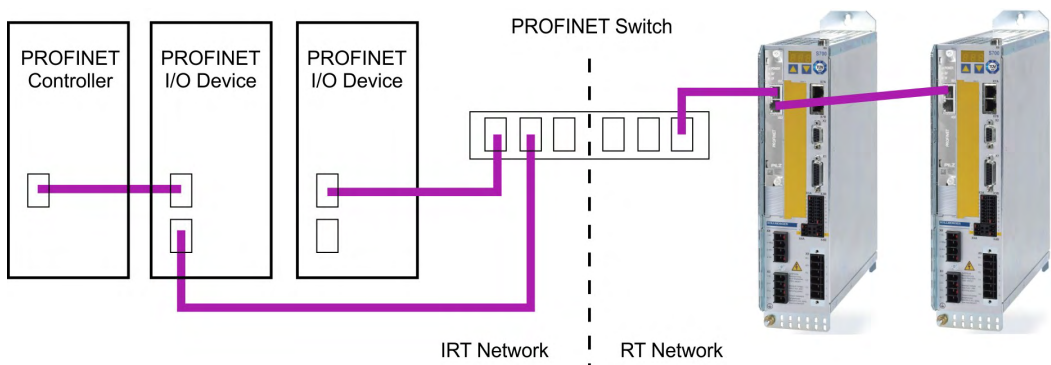

### 3.1.7 Standard functions for data exchange with the servo amplifier

Kollmorgen supplies an S7 function block (FB10), which enables the control functions of the servo amplifier to be handled very easily.

A description of the function block is available as a PDF file on the supplied CDROM and can be downloaded from our website.

## 3.2 Setup

### 3.2.1 Guide to setup

#### NOTICE

Only properly qualified personnel with professional expertise in control and drive technology are permitted to setup the servo amplifier.



#### **WARNING** Automatic Start!

Risk of death or serious injury for humans working in the machine. The drive performing unplanned movements during commissioning cannot be ruled out.

Make sure that, even if the drive starts to move unintentionally, no danger can result for personnel or machinery. The measures you must take in this regard for your task are based on the risk assessment of the application.

<b>Check assembly and installation</b>	Check that all the safety instructions, which are included in both the instructions manual for the servo amplifier and in this manual, have been observed and implemented.
<b>Connect PC, start setup software</b>	Use the setup software for setting the parameters for the servo amplifier.
<b>Setup the basic functions</b>	Now setup the basic functions of the servo amplifier including tuning the servo loops. This part of setup is described in the online help system of the setup software
<b>Save parameters</b>	When the optimization is finished, save the controller parameters in the servo amplifier.
<b>Test the bus connection</b>	Remove the Enable signal (Terminal X3) and switch off the mains power supply for the servo amplifier. The 24V DC auxiliary voltage remains switched on. <ul style="list-style-type: none"> <li>• f the PROFINET connection and the interface to the PROFINET master.</li> <li>• Check the PROFINET parameter settings and the station configuration.</li> <li>• Check the parameter settings for the PROFINET interface module.</li> <li>• Check the PLC user</li> </ul>

### 3.2.2 Important amplifier configuration parameters

The following parameters configure the amplifier for PROFINET. They can be set using the setup software for the servo amplifier.

#### Connection monitoring

[EXTWD](#) (PNU 1658), (DriveGUI screen PROFINET, PN-PZD-Timeout)

#### Behaviour of the outputs when IOPS = Bad

Parameter	Value	Description
Slot	1	PROFINET IO Slot
IOPS	0x00	Bad → Input data invalid
Input Status Amplifier	→ Input data become = 0x00	
	0x80	Good → Input data valid → Input data

#### Behaviour of the outputs when connection is lost

To prevent the drive from responding in an unwanted way when the PROFINET connection is interrupted (an open circuit, for example), you should monitor the arrival of cyclical process data.

The parameter [EXTWD](#) can be used to define the reaction monitoring time (Watchdog) for the fieldbus/slot communication.

Monitoring is only active if the parameter [EXTWD](#) has a value greater than zero (EXTWD = 0, monitoring switched off) and the output stage is enabled.

If the set time has elapsed and the watchdog timer has not been retriggered by the arrival of a telegram, warning "n04" reaction monitoring is generated and the drive is stopped.

The amplifier remains ready for operation and the output stage is enabled.

This warning "n04" must be cleared ([CLRFAULT](#) function or INxMODE = 14) before a new motion command (setpoint value) is accepted.

When you activate the timeout (EXTWD), the amplifier behaves as follows in the case of an error:

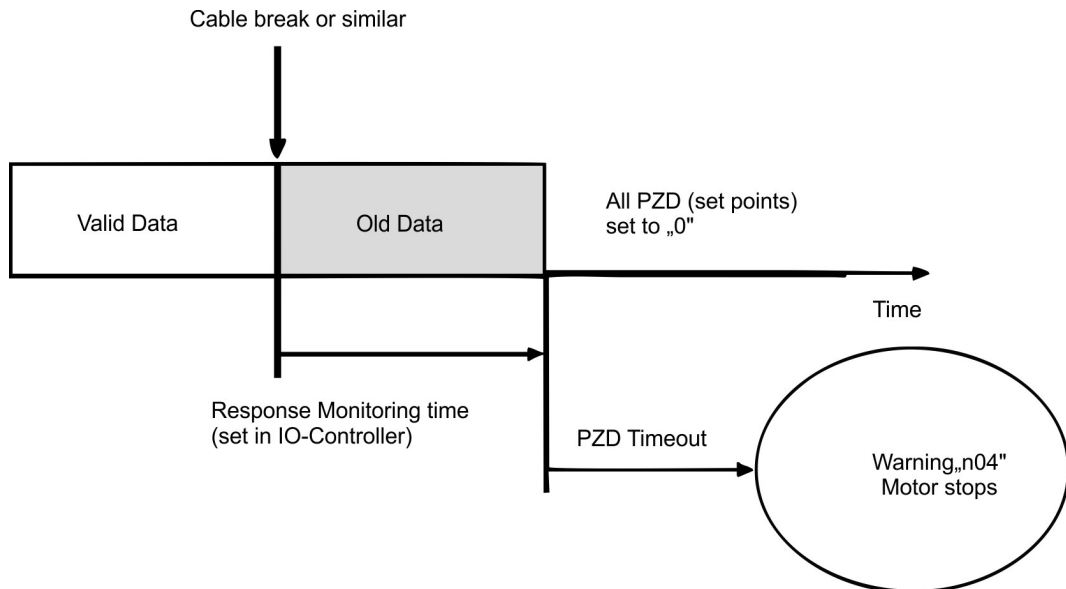

The motor then does not start up automatically. A zero telegram has to be sent again, or PROFINET has to be re-initialised.



#### **WARNING** Automatic Start!

Depending on the application, risk of death or serious injury for humans working in the machine. When the reaction monitoring time parameter (Watchdog) EXTWD is set to "0", the motor stops when connection to PROFINET is lost. The motor continues to run after the connection has been established again.

Make sure that, even if the drive starts to move unintentionally, no danger can result for personnel or machinery. The measures you must take in this regard for your task are based on the risk assessment of the application.

**Behaviour of the outputs after power on**

Operating mode -126 (safe state) is always set when the servo amplifier is switched on. The outputs are also set to "0".

**AENA (PNU 1606)**

With this parameter, the state of the software-enable after switch-on can be defined. The software-enable allows an external control to enable/disable the output stage. For amplifiers with analog set-points ([OPMODE](#) = 1,3) the software-enable is set automatically after switch-on and the devices are ready for operation immediately (if hardware-enable is present). For all others, software-enable will be set to the value of [AENA](#). The variable [AENA](#) also has functionality when resetting the amplifier after an error (by digital input 1 or the [CLRFAULT](#) command). If an error can be reset by the software, the software-enable is set to the value of [AENA](#) after the error is cleared. In this way the behavior of the amplifier after a software-reset is similar to after the drive is switched on.

**INPT0 (PNU 1904)**

With [INPT0](#) a delay for the in-position message can be set. With the start of a motion task the in-position message is deleted and the monitoring of the position is activated after expiration of the adjusted time. This function is particularly important for positioning procedures within the in-position window. In this case the in-position message is delayed for a defined time.

**PNSTNAME**

Command [PNSTNAME](#) is used to define the amplifier's fieldbus device name.

**NOTE**

Each device name in the PROFINET network may be assigned once only.

The device name is limited to 127 characters in total.

- A name component within the device name may be a max. 63 characters in length. (One character string between two points.)
- Permitted characters: Letters "a" ... "z", digits "0" ... "9", hyphen or dot.
- Upper case characters may not be used in the device name.
- The device name may not start or end with the following characters: "-" and "."
- The device name may not start with digits.
- The device name may not have the format n.n.n. (n = 0 ... 999)
- The device name may not start with the character string "port-xyz-" (xyz = 0 ... 9)
- Device names are assigned to the PROFINET IO devices in the commissioning phase.

Assigning the station name with DRIVEGUI.EXE

The station name can be set on screen page *PROFINET* (→ # 15).

Assigning the number of the PROFINET device name at the servo amplifier

The number of the PROFINET device name can also be assigned via the arrow keys at the servo amplifier (see instruction manual of the servo amplifier).

**NOTE**

The "[RSTVAR](#)" command (parameters are set to default values) is used to reset the PROFINET device name to the set [ADDR](#) "s300s700-drive-0 to s300s700-drive-127". When no "ADDR" is set at the amplifier, the amplifier is given the device name "s300s700-drive-0".

**PNIP**

The [PNIP](#) command is used to define the amplifier's fieldbus IP address. The assignment is normally made automatically through the controller (AC500, S7, TIA). However, in some cases the PROFINET IO devices may also be assigned a manual IP address. This is stored in the amplifier in remanent memory.

**NOTE**

The network mask should be stated in the correct format.

#### **PNGWAY**

The [PNGWAY](#) command is used to define the amplifier's fieldbus gateway. The assignment is normally made automatically through the controller (S7, TIA). However, in some cases the PROFINET IO devices may also be assigned a manual gateway. This is stored in the amplifier in remanent memory.

#### **NOTE**

The gateway address should be stated in the correct format.

#### **PNMS**

The ASCII command [PNMS](#) can be used to set the PROFINET cycle time on the amplifier. It is possible to set the bus cycle time to 1 ms or 4 ms.

#### **NOTE**

Under the following conditions the cycle time is set to 4 ms automatically:

In the servo amplifier a safety card with the Encoder types (FBTYPE 12, 16, 17, 27) is built in, and the bus cycle time has been changed from 4 ms to 1 ms.

### 3.2.3 Setup Software

#### 3.2.3.1 Screen page PROFINET

The PROFINET specific parameters, the bus status, and the data words in the transmit and receive directions (as seen by the bus-master) are displayed on this screen page. This page is helpful when searching for errors and commissioning the bus communication.

PN-Station name	The actual name is visible in the top left field. A new name can be entered in the input field (top right position). Setup see <a href="#">PNSTNAME</a> . You can enter upper or lower case characters and numbers. Upper case characters will be switched to lower case characters automatically and then send to the servo amplifier. When setting the name in the screen page <i>TERMINAL</i> , use upper case characters and numbers only.
PNP-ZD-Timeout	Monitoring time (watchdog timer) for the fieldbus/slot communication. Setup see <a href="#">EXTWD</a> .
Manual configuration of IP Data:	If the checkbox is set, addresses (IP, subnet, gateway) can be changed manually. If the checkbox is not set, the addresses given by the DHCP-Server are visible.
PN-IP Address [actual]	IP Adresse des PROFINET Slave, siehe <a href="#">PNIP</a> und <a href="#">PNIPACT</a>
PN-Submask[actual]	Subnet Maske, see <a href="#">PNMASK</a> and <a href="#">PNMASKACT</a>
PN-Gateway [actual]	Gateway Address, see <a href="#">PNGWAY</a> and <a href="#">PNGWAYACT</a>
PROFINET diagnostic information	Diagnosis, see <a href="#">PNSTATE</a>
Device information	Device data, see <a href="#">PNGSERNO</a>
Ignore Treshold Monitoring	If the checkbox is set, the I/O buffer are visible always, even if the PROFINET communication is in failure state.
Input/Output-Buffer	Shows the present status of the bus communication. Data can only be transferred when the "Communication OK" message appears.
Input	The last bus object received by the master.
Output	The last bus object transmitted by the master.
<b>NOTE</b>	Data for input/output is only transmitted if reaction monitoring for the servo amplifier has been activated in the hardware configuration on the master.

### 3.2.3.2 Screen page PROFINET Instrument control

On this screen page the individual bits of the control word (STW) and the status word (ZSW) are shown. The device status resulting from the status word is visualized in the status machine. The current status is shown as black, all others are grey. Additionally the previous status is shown by emphasizing the number of the appropriate arrow.

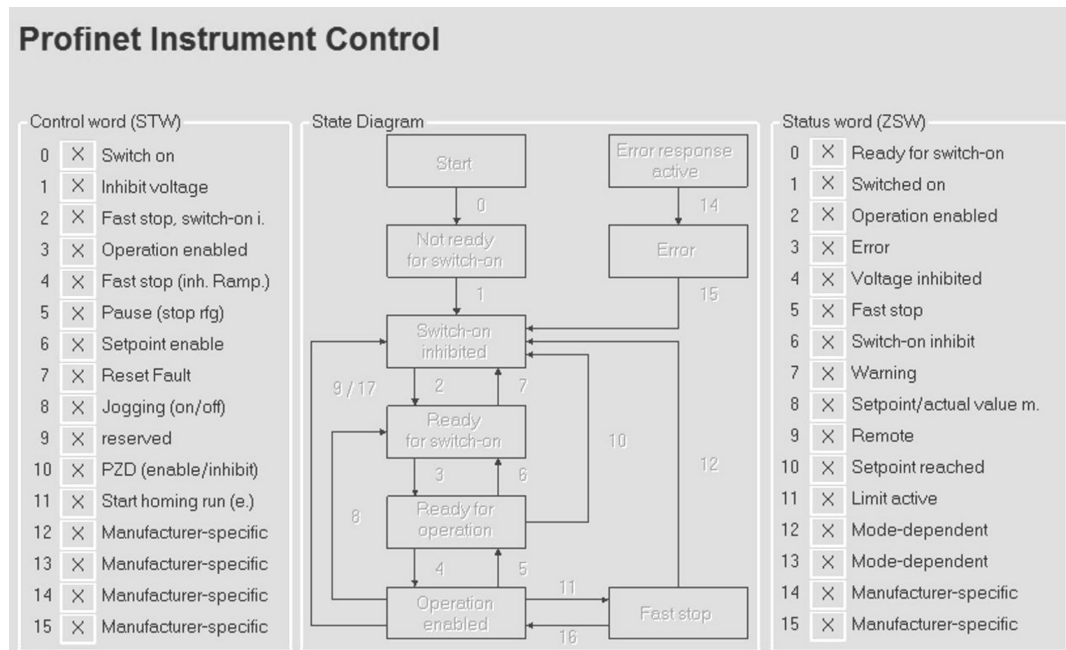





## 4.1 Parameter channel

### 4.1.1 Parameter ID (PKE)

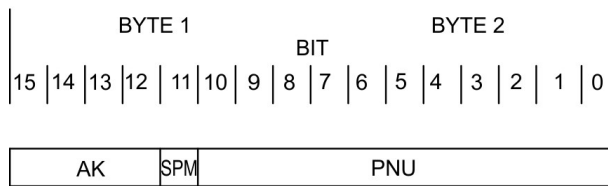

#### Abbreviations

AK	Order / response ID
SPM	Toggle-Bit für spontaneous message (not implemented at present)
PNU	Parameter number

Marked lines in the table are valid for the servo amplifier

Master → Slave		Slave → Master	
Task ID	Function	Response ID positive	Response ID negative
<b>0</b>	<b>no task</b>	<b>0</b>	<b>0</b>
<b>1</b>	<b>request parameter value</b>	<b>1,2</b>	<b>7</b>
2	alter parameter value [W]	1	7/8
<b>3</b>	<b>alter parameter value [DW]</b>	<b>2</b>	<b>7/8</b>
4	request description element	3	7
5	alter description element	3	7/8
6	request parameter value [A]	4,5	7
7	alter parameter value [A/W]	4	7/8
8	alter parameter value	5	7/8
9	request number of array elements	6	7
10 - 15	reserved		

#### 4.1.1.1 Interpretation of the response IDs

Marked lines in the table are valid for the servo amplifier

Response ID	Interpretation
<b>0</b>	<b>no task</b>
1	transmit parameter value
<b>2</b>	<b>transmit parameter value</b>
3	transmit description element
4	transmit parameter value
5	transmit parameter value
6	transmit number of array elements
<b>7</b>	<b>task not possible (with error no.)</b>
8	no operating authority for PKW interface
9	spontaneous message [W]
10	spontaneous message [DW]
11	spontaneous message [A/W]
12	spontaneous message [A/DW]

#### Abbreviations in the tables:

A:Array, W:Word, DW:Double-word

## 4.1.1.2 Response ID 7: Profile specific error numbers

Error no.	Description
0	illegal PNU
1	parameter value cannot be changed
2	Lower or upper limit violated
3	Erroneous sub-index
4	no array
5	Incorrect data type
6	setting not allowed (can only be reset)
7	Descriptive element cannot be changed
8	PPO-write, requested in IR, not available
9	descriptive data not available
10	access group incorrect
11	No parameter change rights
12	Password incorrect
13	Text cannot be read in cyclic data transmission
14	Name cannot be read in cyclic data transmission
15	text array not available
16	PPO-write missing
17	opmode switch over not possible at STW Bit 10 = 1 (PZD enable)
18	other error
19-100	reserved
101	faulty task ID
102	software error (command table)
103	only possible in disabled state
104	only possible in enabled state
105	BCC-error in the EEPROM data
106	only possible after task is stopped
107	wrong value [16,20]
108	wrong parameter (OCOPY x [y] z)
109	wrong motion block no. (0,1..180,192..255)
110	wrong parameter (PTEACH x [y])
111	EEPROM write error
112	wrong value
113	BCC-error in motion block
114	Object is read only or write only
115	not possible due to operation status (e.g. output stage enabled)
>115	reserve

## 4.1.2 Index IND

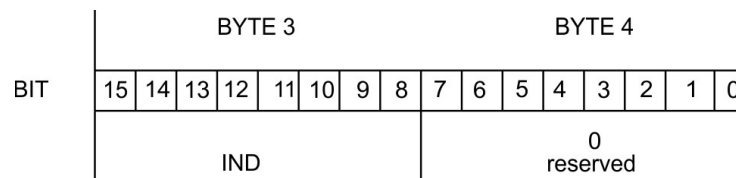
**NOTE**

An Index (IND) unequal to 0 is used for reading and writing amplifier parameters with PNUs > 1600. See (→ # 31, Manufacturer specific object channel (from PNU 1600) ) for further description.

### 4.1.3 Parameter value PWE

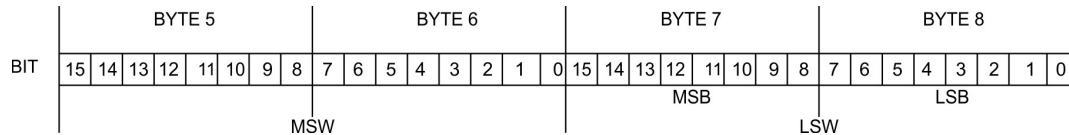

The data for the PNU-variable is contained in the PWE, and is placed flush right (PKE):

4-byte data (double-word)PWE 5-8 (PWE 8 LSB)

Commands are transferred right justified with task ID 3. If a command cannot be executed, the response identification AK = 7 signals the error, and an error number is given out.

Error numbers (→ # 19).

## 4.2 The process data channel (PZD)

Cyclical data are exchanged across the PROFINET through the process data section of the 20-byte telegram. Each PROFINET cycle triggers an interrupt in the servo amplifier and new process data is exchanged and processed. The interpretation of the PZD by the amplifier depends on the operating mode that is set. The operating mode is set through a PROFINET parameter (PNU 930 (→ # 24)).

In all operating modes, data word 1 of the process data (PZD1) in the direction from control system to servo amplifier is used for instrument control, and in the direction from servo amplifier to control system it has the function of a status indicator for the amplifier.

The interpretation of the process data PZD2 – PZD6 changes depending on the operating mode (→ # 37).

### NOTICE

When the servo amplifier is switched on, the PROFIDRIVE operating mode that is always set to –126 (safe state). Before changing the operating mode, bit 10 of the control word STW must always be set to 0. The new operating mode only becomes active when bit 10 of the control word is set to 1 (→ # 24).

## 5 Parameter channel (PKW)

The digital servo amplifiers of the servo amplifier series have to be adapted to the circumstances of your machine. The parameters for the controllers are set using either the setup software or via the PROFINET.

### 5.1 Read/write an amplifier parameter

Read (AK = 1) or write (AK = 3) amplifier parameters

Writes or reads an amplifier parameter, which is identified by the parameter number (PNU), into the *volatile* memory of the servo amplifier..

The parameters that are written to the servo amplifier can be transferred to the *non-volatile* memory by using the command “non-volatile parameter save” (PNU 971).

#### Telegram layout

	Request	Response
PKE/AK	1 (read) / 3 (write)	2 (OK) / 7 (error)
PKE/PNU	(→ # 21)	as transmitted
PWE	for AK = 3 data type see (→ # 21) for AK = 1 data type: irrelevant	for AK = 3 mirrored PWE of the request for AK = 1 data type see (→ # 21)

### 5.2 Summary of the parameter numbers

All the parameter numbers (PNUs) for the servo amplifier are listed in numerical order in the table on page (→ # 21) with a short description. The parameter numbers in the range 900 – 999 are profile-specific for the PROFINET drive profile PROFIDRIVE. Parameter numbers > 999 are manufacturer-specific.

For better understanding, you can look up the ASCII commands which are in the column “ASCII command” in the online help the setup software. A description of all ASCII commands can be found in the ASCII reference lists (referring to the servo amplifier type) located on the product CDROM and on our website.

#### NOTE

Parameter numbers >1600 use the object channel (→ # 31).

## 5.2.1 List of the parameters

PNU	Data type	Access	Description	ASCII Command
<b>Profile parameter</b>				
904	UINT32	ro	Number of the supported PPO-write, always 2	-
911	UINT32	ro	Number of the supported PPO-read, always 2	-
918	UINT32	ro	Participant address on PROFIBUS	ADDR
930	UINT32	r/w	Selector for operating mode	-
963	UINT32	ro	PROFIBUS baud rate	-
965	Octet-String2	ro	Number of the PROFIDRIVE profile (0302H)	-
970	UINT32	wo	Load default parameter set	RSTVAR
971	UINT32	wo	non-volatile parameter save	SAVE
<b>Manufacturer-specific parameters</b>				
<b>General parameters</b>				
1000	Visible String4	ro	Instrument ID	-
1001	UINT32	ro	Manufacturer-specific error register	ERRCODE
1002	UINT32	ro	Manufacturer-specific status register	-
<b>Speed controller parameters</b>				
1672	UINT32	r/w	Kp – gain factor of speed controller	GV
1677	UINT32	r/w	Tn – integral-action time for speed controller	GVTN
1601	UINT32	r/w	Setpoint ramp+, speed controller	ACC
1634	UINT32	r/w	Setpoint ramp-, speed controller	DEC
1637	UINT32	r/w	Emergency stop ramp, speed controller	DECSTOP
1890 / 1891	UINT32	r/w	Maximum speed	VLIM / VLIMN
1895	UINT32	r/w	Overspeed	VOSPD
1642	UINT32	r/w	Count direction	DIR
<b>Position controller parameters</b>				
1894	UINT32	r/w	Velocity multiplier for jogging/homing	VMUL
1807	UINT32	r/w	Axis type	POSCNFG
1798	INTEGER32	r/w	InPosition window	PEINPOS
1799	INTEGER32	r/w	Following error window	PEMAX
1860	INTEGER32	r/w	Position register 1	SWE1
1862	INTEGER32	r/w	Position register 2	SWE2
1803	UINT32	r/w	Denominator resolution	PGEARO
1802	UINT32	r/w	Numerator resolution	PGEARI
1814	UINT32	r/w	Minimum acceleration/braking time	PTMIN
1669	UINT32	r/w	Feed-forward factor for position controller	GPFFV
1666	UINT32	r/w	KV factor for position controller	GP
1816	UINT32	r/w	Configuration variable for software switch	PVMAX
1856	UINT32	r/w	Tn integral-action time for position controller	SWCNFG
<b>Position data for the position control mode</b>				
1790	INTEGER32	r/w	Position	O_P
1791	INTEGER16	r/w	Velocity	O_V
1785	UINT32	r/w	Motion task type	O_C
1783	INTEGER16	r/w	Starting time (acceleration)	O_ACC
1786	INTEGER16	r/w	Braking time (deceleration)	O_DEC
1788	UINT32	r/w	Number of next motion task	O_FN
1789	UINT32	r/w	Start delay for next motion task	O_FT
1310	2 * UINT16	wo	Copy a motion task	OCOPY
<b>Position set-up mode</b>				
1773	UINT32	r/w	Homing type	NREF
1644	UINT32	r/w	Homing direction	DREF

PNU	Data type	Access	Description	ASCII Command
1602	UINT32	r/w	Acceleration ramp (jogging/homing)	ACCR
1636	UINT32	r/w	Braking ramp	DECR
1831	UINT32	r/w	Reference offset	ROFFS
1896	UINT32	ro	Homing run velocity	VREF
1889	UINT32	ro	Jogging velocity	VJOG
<b>Actual values</b>				
1400	INTEGER32	ro	Actual position 20 bits/turn	PRD
1800	INTEGER32	ro	SI-position, actual value	PFB
1815	INTEGER32	ro	SI-velocity, actual value	PV
1797	INTEGER32	ro	SI following error	PE
1688	INTEGER32	ro	RMS current	I
1880	INTEGER32	ro	SI-speed, actual value	V
1873	INTEGER32	ro	Heatsink temperature	TEMPH
1872	INTEGER32	ro	Internal temperature	TEMPE
1882	INTEGER32	ro	DC-bus (DC-link) voltage	VBUS
1792	INTEGER32	ro	Regen power	PBAL
1689	INTEGER32	ro	I2t loading	MI2T
1876	INTEGER32	ro	Running time	TRUN
<b>Digital I/O configuration</b>				
1698	UINT32	r/w	Function of digital input 2	IN1MODE
1701	UINT32	r/w	Function of digital input 3	IN2MODE
1704	UINT32	r/w	Function of digital input 4	IN3MODE
1707	UINT32	r/w	Auxiliary variable for digital input 1	IN4MODE
1699	INTEGER32	r/w	Auxiliary variable for digital input 2	IN1TRIG
1702	INTEGER32	r/w	Auxiliary variable for digital input 3	IN2TRIG
1705	INTEGER32	r/w	Auxiliary variable for digital input 4	IN3TRIG
1708	INTEGER32	r/w	Function of digital input 1	IN4TRIG
1775	INTEGER32	r/w	Function of digital input 2	O1MODE
1778	INTEGER32	r/w	Auxiliary variable for digital output 1	O2MODE
1776	UINT32	r/w	Auxiliary variable for digital output 2	O1TRIG
1779	UINT32	r/w	State of 4 digital inputs, Enable, 2 digital outputs	O2TRIG
1852	UINT32	r/w	Function of digital input 2	STATIO
<b>Analog configuration</b>				
1607	UINT32	r/w	Configuration of the analog input functions	ANCNFG
1611	UINT32	r/w	Offset voltage for analog input 1	ANOFF1
1617	UINT32	r/w	Filter time constant for analog input 1	AVZ1
1897	UINT32	r/w	Scaling factor for velocity, analog input 1	VSCALE1
1713	UINT32	r/w	Scaling factor for current, analog input 1	ISCALE1
1612	UINT32	r/w	Offset voltage for analog input 2	ANOFF2
1898	UINT32	r/w	Scaling factor for velocity, analog input 2	VSCALE2
1714	UINT32	r/w	Scaling factor for current, analog input 2	ISCALE2
<b>Motor parameters</b>				
1735	UINT32	r/w	Brake configuration	MBRAKE
1753	UINT32	r/w	Motor number from motor database	MNUMBER
<b>Manufacturer specific object channel</b>				
	(→ # 31) and description of the ASCII-commands in the online help.			

**Abbreviations in the "Access" column**

**wo** = "write only" access, **ro** = "read only" access, **r/w** = read and write access

## 5.2.2 Profile Parameters

### 5.2.2.1 PNU 970: Default parameters

Used to reject all the parameters that are set and load the manufacturer's default values.

### 5.2.2.2 PNU 971: Non volatile saving of parameters

With this parameter you can save all the parameter settings to the EEPROM. To do this, the parameter must have the value PWE = 1 when the transfer takes place.

### 5.2.2.3 PNU 930: Selection Switch for Operating Modes

The "Selector for operating modes" is defined by the drive profile, and mirrors the operating modes of the drive profile to the operating modes of the servo amplifier. The following table shows a summary of the operating modes:

**NOTE**

If process data are exchanged across the PROFINET, then the operating modes of the drive profile must only be selected with PNU 930.

Operating mode drive profile	Operating mode "OPMODE"	Description
2	8	Positioning mode according to PROFIDRIVE profile
1	0	Digital speed control acc. to PROFIDRIVE profile
0	-	reserved
-1	1	Speed control, analog setpoint
-2	2	Torque control, digital setpoint
-3	3	Torque control, analog setpoint
-4	4	Position control, electronic gearing
-5	5	Position control, external trajectory
-6	-	reserved
-7	-	Speed control, digital setpoint & Servo Pump
-8 to -15	-	reserved
-16	-	ASCII channel for expanded parameterization
-17 to -125	-	reserved
-126	-	Initial settings when amplifier is switched on

Operating modes (→ # 37). A change of operating mode can only be done in connection with the control word. Ensure the following sequence when changing the operation mode:

- Inhibit setpoints and process data**  
 Bit 10 in the control word is set to 0, so that no new setpoints will be accepted by the servo amplifier and no new control functions can be initiated. A new operating mode can, however, be selected while a motion function is being performed.  
 The control word is only inhibited to the extent that the servo amplifier can always be switched into a safe state.
- Select the new operating mode with PNU 930**  
 The new operating mode is selected with parameter 930 through the parameter channel, but not yet accepted.
- Set/receive the setpoints and actual values**  
 Enter the corresponding setpoints in the setpoint area of the process data. Here you must take note that the normalization and data formats depend on the operating mode that is selected. The interpretation of the actual values is also altered ((→ # 17) and (→ # 37)). The user program must respond accordingly.
- Enable the setpoints**  
 Bit 10 of STW is set to 1. The setpoints are immediately accepted and processed. The new actual values are output with the appropriate normalization and data format.

**NOTICE**

After switch-on or after a coldstart the servo amplifier is always in the safe operating mode. In the safe operating mode (-126), no motion functions can be initiated via the PROFINET. However, it is possible to perform motion functions with the the setup Software.

If the operating mode is changed, then motion functions can only be operated via the PROFINET. If the operating mode is changed via another communication channel, then the amplifier is emergency braked and the error F21 (Handling error, expansion card) is signaled.



## 5.2.3 Manufacturer specific parameters

### 5.2.3.1 PNU 1000: Instrument ID

The instrument ID consists of four ASCII characters, with the contents "Sxyz".

x defines for the servoamplifier family

yz defines for the current level of the output stage

### 5.2.3.2 PNU 1001: Manufacturer specific error register

The assignment of the error register can be seen in the following table. The explanation of the individual errors can be found in the assembly & installation instructions for the servo amplifier.

Bit	Description	
0	Error F01:	Heatsink temperature
1	Error F02:	Overvoltage
2	Error F03:	Following error
3	Error F04*:	Feedback
4	Error F05:	Undervoltage
5	Error F06*:	Motor temperature
6	Error F07*:	Auxiliary voltage
7	Error F08:	Overspeed
8	Error F09*:	EEPROM
9	Error F10*:	Flash-EEPROM
10	Error F11*:	Mechanical holding brake
11	Error F12*:	Motor phase
12	Error F13:	Internal temperature
13	Error F14*:	Output stage
14	Error F15:	I <sup>2</sup> t max.
15	Error F16:	Mains supply-BTB
16	Error F17*:	A/D-converter
17	Error F18*:	Regen circuit
18	Error F19:	Mains supply phase
19	Error F20*:	Expansion card error
20	Error F21*:	Handling error, plug-in card
21	Error F22:	Earth short
22	Error F23:	CAN-Bus off
23	Error F24:	Warning
24	Error F25:	Commutation error
25	Error F26:	Limit switch
26	Error F27:	AS functionality
27-30	Error F28 - F31*:	reserved
31	Error F32*:	System error

When the cause of the error has been cleared, the error state can be canceled by setting Bit 7 in the control word (STW).

The error response of the servo amplifier to the reset will differ, depending on the error that has occurred:

For errors that are marked by an asterisk (\*), setting the reset bit initiates a cold-start of the amplifier, whereby the PROFINET communication to this amplifier will also be interrupted for several seconds. Depending on the circumstances, this break in communication may have to be separately handled by the PLC.

For the other errors, the reset leads to a warm start, during which the communication will not be interrupted.

A description of the individual errors and recommendations for removing them can be found in the amplifier's installation manual.

### 5.2.3.3 PNU 1002: Manufacturer specific status register

The bit assignment can be seen in the following table:

Bit	Description
0	Warning 1: I <sup>2</sup> t threshold exceeded (set, as long as I <sub>rms</sub> is above the threshold)
1	Warning 2: Regen power exceeded (set, as long as the set regen power is exceeded)
2	Warning 3: Following error
3	Warning 4: Threshold monitoring (field bus) active
4	Warning 5: Mains supply phase missing
5	Warning 6: Software limit-switch 1 has been activated
6	Warning 7: Software limit-switch 2 has been activated
7	Warning 8: Faulty motion task has been started
8	Warning 9: No reference point was set at the start of the motion task
9	Warning 10: PSTOP active
10	Warning 11: NSTOP active
11	Warning 12: Motor default values were loaded (HIPERFACE® or EnDat® feedback)
12	Warning 13: Expansion card is not working properly
13	Warning 14: Sine encoder commutation not carried out
14	Warning 15: Speed current table error INxMODE 35
15	Warning 16: Reserve
16	Motion task active (is set as long as a position control task is active motion task, jogging, homing).
17	Reference point set (is set after a homing run, or when an absolute position (multi-turn) encoder is used. This is canceled when the amplifier is switched on, or when a homing run is started.
18	Actual position = home position (is set as long as the reference switch is activated).
19	InPosition (is set as long as the difference between the target position for a motion task and the actual position is smaller than PEINPOS. The InPosition signal is suppressed if a following task is started at the target position.
20	Position latch set (positive edge) – this is set if a rising edge is detected on the INPUT2 (IN2MODE=26) that is configured as a latch. This is canceled if the latched position is read out (LATCH16/LATCH32)
21	—
22	Position 1 reached (is set if the configured condition for this signal (SWCNFG, SWE1, SWE1N) is met. Depending on the configuration, this bit is set on exceeding SWE1, or going below SWE1, on reaching the InPosition window SWE1...SWE1N or on leaving the InPosition window SWE1...SWE1N.
23	Position 2 reached (see above)
24	Position 3 reached (see above)
25	Position 4 reached (see above)
26	Initialization completed (is set if the internal initialization of the amplifier is completed).
27	—
28	Speed = 0 (is set as long as the motor speed is below the standstill threshold VEL0).
29	Safety relay has been triggered (is set as long as the safety relay is open AS)
30	Output stage enabled (is set when software and hardware enables are set).
31	Error present (is canceled when the amplifier is switched on, or if the function “Cancel error” is called.

**In the process data, Bits 16 to 31 of the manufacturer-specific status register are given out.**

Warnings 3 and 4 can be reset through Bit 13 in the control word.

## 5.2.4 Position control parameters

### 5.2.4.1 PNU 1894: Velocity multiplier

This parameter is used to enter a multiplier for the jogging/homing velocity. In Positioning opmode, the velocity for jogging/homing is set through PZD2 jogging/homing is started using bit 8/ bit 11 in the control word (STW). The actual jog velocity is calculated according to the following formula:

$$V_{\text{Jog, vel. (32Bit)}} = V_{\text{Jog, PZD2 (16Bit)}} \times \text{Velocity-Multiplier (16Bit)}$$

The default value for PNU 1894 is 1.

### 5.2.4.2 PNU 1807: Axis type

This parameter is used to define the axis type.

Value	S300/S700
0	Linear axis
1	Modulo axis
2	reserved

## 5.2.5 Position data for the position control mode

### 5.2.5.1 PNU 1790: Position

Since the servo amplifier calculates all positioning operations internally only on an incremental basis, there are limitations on the usable range of values for distances that are given in SI (user) units.

The range for the incremental position covers the values from  $-2^{31}$  to  $(2^{31}-1)$ .

The resolution that is determined by the PGEARO (PNU1803 ind1) and PGEARI (PNU1802 ind1) parameters and the variable PRBASE fix the sensibly usable range for positioning operations.

The variable PRBASE determines, through the equation  $n = 2^{\text{PRBASE}}$ , the number of increments per motor turn. The value of PRBASE can only be 16 or 20.

PGEARO contains the number of increments that must be traversed when the distance to be moved is PGEARI. The default values for PGEARO correspond to one turn.

The number of turns that can be covered are given as follows:

$-2048..+2047$  for PRBASE=20 and  $-32768..+32767$  for PRBASE=16

The sensibly usable position range is derived as follows:

$-2^{31} * \text{PGEARI} / \text{PGEARO} \dots (2^{31} - 1) * \text{PGEARI} / \text{PGEARO}$  für  $\text{PGEARI} \leq \text{PGEARO}$

respectively

$-2^{31} \dots (2^{31} - 1)$  for  $\text{PGEARI} > \text{PGEARO}$

### 5.2.5.2 PNU 1791: Velocity

The usable range for the velocity is not limited by the available data area. It is limited by the maximum applicable speed  $n_{\text{max}}$ , which is given by the speed parameter VLIM as the final limit speed for the motor.

The maximum velocity is thus given by:

$$v_{\text{SI, max}} = n_{\text{max}} \times \text{PGEARI} / \text{PGEARO} \times 2^{\text{PRBASE}} \text{ with } n_{\text{max}} \text{ in turns/sec}$$

or, in incremental units, as:

$$v_{\text{incr. max.}} = n_{\text{max}} \times 2^{\text{PRBASE}} \times 250 \mu\text{s}/1\text{s} = n_{\text{max}}/4000 \times 2^{\text{PRBASE}} \text{ with } n_{\text{max}} \text{ in turns/sec}$$

### 5.2.5.3 PNU 1785: Motion task type

Bit	Value	Meaning
0	0	The position value that is given is evaluated as an absolute position.
	1	The position value that is given is evaluated as a relative traversing distance. The two following bits then determine the type of relative motion.
1	0	If Bit 1 and Bit 2 are set to 0 and Bit 0 set to 1, then the relative motion task is performed according to the "InPosition" bit.
	1	The new target position is given by the old target position plus the traversing distance. Bit 1 has priority over Bit 2.
2	0	If Bit 1 and Bit 2 are set to 0 and Bit 0 set to 1, then the relative motion task is performed according to the "InPosition" bit.
	1	The new target position is given by the actual position plus the traversing distance.
3	0	no following task available
	1	There is a following task, but it must be defined through parameter O_FN, PNU 1788
4	0	Change over to next motion task, with braking to 0 at the target position.
	1	Change over to next motion task, without standstill at the target position. The type of velocity transition is determined by Bit 8.
5	0	Change over to next motion task, without evaluating inputs.
	1	A following motion task is started by a correspondingly configured input.
6	0	Start the next motion task by Input State = low or if bit 7 = 1 after the delay set in PNU 1789.
	1	Start the next motion task by Input State = high or if bit 7 = 1 after the delay set in PNU 1789.
7	0	The next motion task is started immediately.
	1	The next motion task is started after the delay time set by PNU 1789 or, if Bit 6 = 1, previously by a corresponding input signal.
8	0	Only for following motion tasks and Bit 4 = 1: from the target position for the previous motion task onwards, the velocity is altered to the value for the following motion task.
	1	The change of velocity is made so that the velocity at the target position of the previous motion task matches the value given for the following motion task.
9, 10, 11		reserved
12	0	Accelerations are calculated according to the run-up/acceleration and run-down/braking times for the motion task.
	1	the deceleration/acceleration ramps are interpreted in mm/s <sup>2</sup>
13	0	The target position and target velocity of a motion task are interpreted as increments.
	1	The target position and target velocity are recalculated as increments before the start of the motion task. The parameters PGEAR1 and PGEARO are used for this purpose.
14	0	The programmed velocity is used as the velocity for the motion task.
	1	The velocity for the motion task is determined by the voltage present on analog input 1 at the start of the motion task.
15	-	reserved
16	0	a motion task with trapezoid profile is started
	1	a table motion task (sin2 profile) is started. Bit 9 must be set to 0.

Bits 0 to 15 are transmitted as motion task type in PZD 6 (mode "positioning") with direct motion tasks.

Bit 16 is not affected by the motion task type transmitted with the process data in PZD 6 and therefore must be written with PNU 1785 to the parameter channel.

### 5.2.5.4 PNU 1783: Acceleration time

This parameter defines the total time or rate (depending on the type of units selected for acceleration) to reach the target velocity for the motion task.

**5.2.5.5 PNU 1786: Deceleration time**

This parameter defines the total time or rate (depending on the type of units selected for deceleration) to reduce the velocity to 0 at the target position.

**5.2.5.6 PNU 1788: Next motion task**

The motion task number of the motion task to be started can be from 1 bis 200 (motion tasks in EEPROM) or 201 .. 300 (motion tasks in RAM).

**5.2.5.7 PNU 1789: Start delay**

This parameter is used to set a delay time before the start of a motion task.

**5.2.5.8 PNU 1310: Copy motion task**

This parameter can be used to copy motion tasks. The source motion task must be entered in the high-value portion of PWE (PZD 5 & 6) and the target motion task must be entered in the low-value portion of PWE (PZD 7 & 8).

**5.2.6 Setup mode Position****5.2.6.1 PNU 1773: Homing type**

This parameter can be used to determine which type of homing run should be applied. The assignment can be seen in the following table:

PWE	Type of homing run
0	Reference point at the present position
1	Initiator with resolver zero mark
2	Hardware limit-switch resolver zero mark
3	Initiator without resolver zero mark
4	Hardware limit-switch without resolver zero mark
5	Zero mark / feedback unit
6	Reference point at the actual position
7	Hardware limit-switch with resolver zero mark
8	Absolute SSI-position
9	Move to Mechanical Stop

**5.2.6.2 PNU 1644: Homing direction**

This parameter can be used to determine the direction of motion for homing runs. If set equal 0, then the direction of motion is negative; for a value 1 it is positive, and for a 2 it depends on the distance to the reference point in the direction in which the homing run started.

**5.2.7 Actual values****5.2.7.1 PNU 1800: Actual position value in SI (User) units**

The parameter value is the actual SI (user unit) position value.

## 5.2.8 Digital I/O Configuration

All settings for the digital inputs and outputs only become effective after being saved in the EEPROM and then switching off and on again, or making a cold start of the servo amplifier. Details on each configuration setting can be seen in the user manual for the setup software.

### 5.2.8.1 PNUs 1698/1701/1704/1707: Digital input configuration

This parameter can be used to configure the digital inputs 1 to 4 individually.

The configurable functions depend on the used amplifier and are described in the ASCII Object Reference.

### 5.2.8.2 PNUs 1775/1778: Digital output configuration

These parameters can be used to configure the two digital outputs individually. The configurable functions depend on the used amplifier and are described in the ASCII Object Reference.

## 5.2.9 Analog configuration

All settings for the analog inputs and outputs only become effective after being saved in the EEPROM and then switching off and on again, or making a cold start of the servo amplifier. The significance of the functions can be seen in the user manual for the setup Software.

### 5.2.9.1 PNU 1607: Analog input configuration

This parameter can be used to configure the two analog inputs together. The configurable functions depend on the used amplifier and are described in the ASCII Object Reference.

### 5.2.10 Manufacturer specific object channel (from PNU 1600)

With PNUs > 1600 you can program each ASCII-parameter/command of the servo amplifier. The PNU can be calculated by the object number with a specific offset (ASCII command reference list: DPR). All PNUs described in this manual can be reached with index=1. In the ASCII reference list you find for every parameter the PNU and the referring index. More functions of the object channel can be used with the indices listed below.

The offset and the indices that must be used depend on the object number:

Object number	Offset	PNUs	Index
0 ...447	1600	1600 ...2047	00h ...08h (1 ... 8dec)
448 ...847	1200	1648 ...2047	10h ...18h (16 ... 24dec)
848 ...1047	800	1648 ...2047	20h ...28h (32 ...40dec)

Index	0/10h/ 20h depending on the object no. (see above)
Short description	Number of entries
Unit	—
Access	ro
Data type	UNSIGNED8
Value range	8
EEPROM	—

Index	1/11h/ 21h depending on the object no. (see above)
Short description	read/write a parameter
Unit	see corresponding ASCII-command
Access	see corresponding ASCII-command
Data type	see corresponding ASCII-command
Value range	see corresponding ASCII-command
Default value	—
EEPROM	see corresponding ASCII-command

Index	2/12h/ 22h depending on the object no. (see above)
Short description	read lower limit
Unit	see corresponding ASCII-command
Access	Read only
Data type	see corresponding ASCII-command
Value range	see corresponding ASCII-command
Default value	—
EEPROM	—

Index	3/13h/ 23h depending on the object no. (see above)
Short description	read upper limit
Unit	see corresponding ASCII-command
Access	Read only
Data type	see corresponding ASCII-command
Value range	see corresponding ASCII-command
Default value	—
EEPROM	—

Index	4/14h/ 24h depending on the object no. (see above)
Short description	read default value
Unit	see corresponding ASCII-command
Access	Read only
Data type	see corresponding ASCII-command
Value range	see corresponding ASCII-command
Default value	—
EEPROM	—

Index	5/15h/ 25h depending on the object no. (see above)
Short description	read object format
Unit	—
Access	Read only
Data type	see corresponding ASCII-command
Value range	see corresponding ASCII-command
Default value	—
EEPROM	—

The following object formats are possible:

0. Function (no parameters – write only)
1. Function (32-Bit parameter)
2. Function (32-Bit parameter with weighting 3)
3. 8-Bit integer
4. 8-Bit unsigned integer
5. 16-Bit integer
6. 16-Bit unsigned integer
7. 32-Bit integer
8. 32-Bit unsigned integer
9. 32-Bit integer (weighting 3)

Index	6/16h/ 26h depending on the object no. (see above)
Short description	read object control data
Unit	—
Access	Read only
Data type	UNSIGNED32
Value range	0 ... $2^{32} - 1$
Default value	—
EEPROM	—

0x00010000 when altered, the variable has to be saved and the amplifier reset

0x00020000 variable will be saved in the serial EEPROM

0x00200000 variable is read-only, must not be written via PROFIBUS

Index	7/17h/ 27h and 8/18h/ 28h
Short description	reserved
Unit	—
Access	Read only
Data type	UNSIGNED32
Value range	0 ... $2^{32} - 1$
Default value	—
EEPROM	—

**NOTE**

Objects with format 0 (index 5) must not be accessed reading (response identification = 1).



## 6 Process data channel

The process data channel is used for real-time communication. This channel is divided into two telegram sections:

- PZD1:** Control word (STW) /Status word (ZSW) – instrument control  
The control word and the status word are used to control the amplifier and monitor the amplifier's status.
- PZD2-6:** Setpoint / actual values depending on the operating mode.  
Setpoints and actual values such as position, velocity and current are exchanged in this section.

The availability of a process data channel is determined in the PROFIDRIVE drive profile. The data that can be transferred is defined according to the operating modes (→ # 24, PNU 930: Selection Switch for Operating Modes),. The process data that are used are determined in such a way that the real-time capability of this channel is optimally used.

In this chapter the instrument control is described first, and then the functions and details of each operating mode.

### 6.1 Instrument control

The control of the amplifier through PROFIBUS is described with the aid of the status machine shown below. The status machine is defined in the drive profile by a flow diagram valid for all operating modes. The following diagram shows different amplifier states for the servo amplifier.

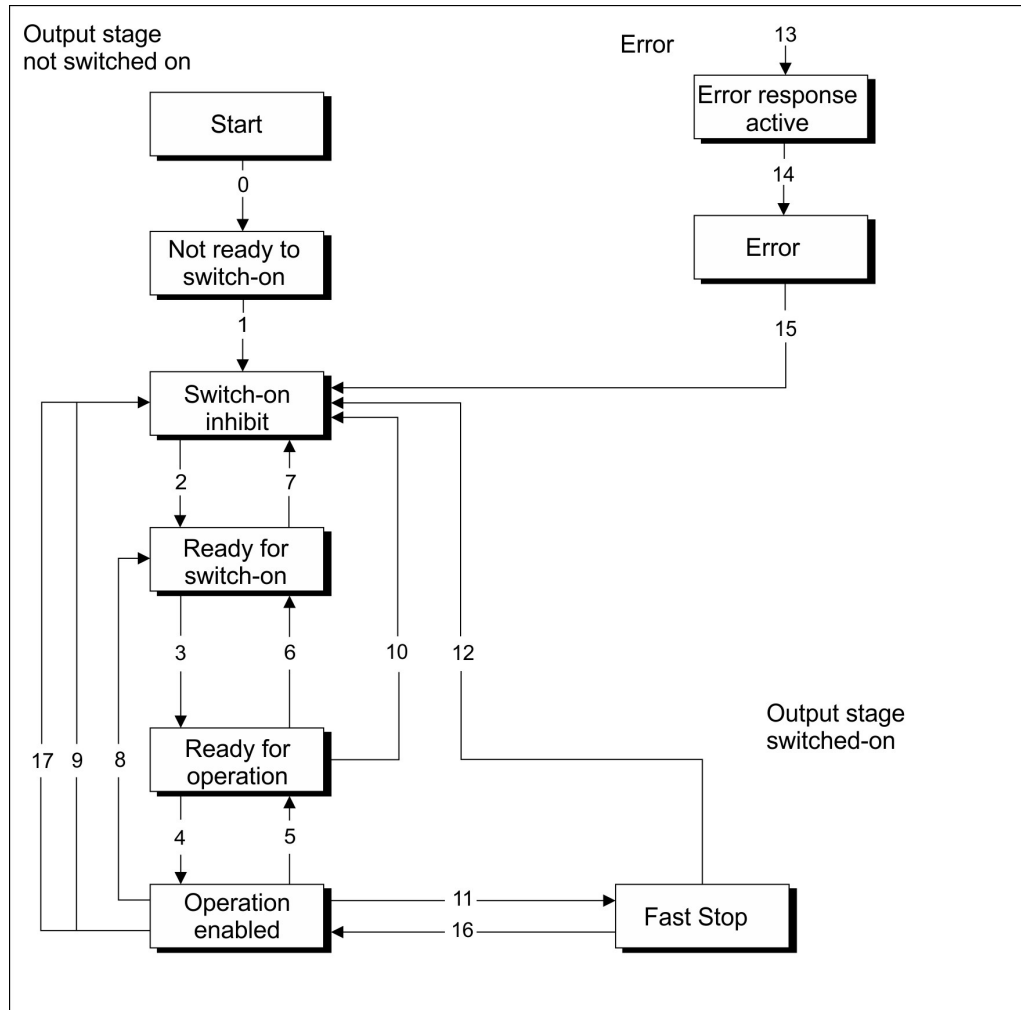

States of the status machine

State	Description
Not ready for switch-on	Servo amplifier is not ready for switch-on. No operation readiness (BTB) is signaled from the amplifier software.
Switch-on inhibited	Servo amplifier is ready for switch-on. Parameters can be transferred, DC bus link can be switched on, motion functions cannot be carried out yet.
Ready for switch-on	DC bus link voltage must be switched on. Parameters can be transferred, motion functions cannot be carried out yet.
Ready for operation	DC bus link voltage must have been switched on. Parameters can be transferred, motion functions cannot be carried out yet. Output stage is switched on (enabled).
Operation enabled	No error present. Output stage is switched on, motion functions are enabled.
Fast stop activated	Drive has been stopped, using the emergency stop ramp. Output stage is switched on (enabled), motion functions are enabled.
Error response active/error	If an amplifier error occurs, the servo amplifier changes to the amplifier state "Error response active". In this state, the power stage is switched off immediately. After this error response has taken place, it changes to the state "Error". This state can only be terminated by the bit-command "Error-reset". To do this, the cause of the error must have been removed (see ASCII command ERRCODE).

**Transitions of the status machine**

Transition	Description	
0	Event	Reset / 24V supply is switched on
	Action	Initialization started
1	Event	Initialization successfully completed, servo amplifier switch-on inhibit
	Action	none
2	Event	Bit 1 (inhibit voltage) and Bit 2 (fast stop) are set in the control word (command: shut-down). DC bus link voltage is present.
	Action	none
3	Event	Bit 0 (switch-on) is also set (command: switch-on)
	Action	Output stage is switched on (enabled). Motor has torque.
4	Event	Bit 3 (operation enabled) is also set (command: operation enable)
	Action	Motion functions are enabled, depending on the operating mode that is set.
5	Event	Bit 3 is canceled (command: inhibit)
	Action	Motion functions are disabled. Motor is braked, using the relevant ramp (depends on operating mode).
6	Event	Bit 0 is canceled (ready for switch-on).
	Action	Output stage is switched off (disabled). Motor has no torque.
7	Event	Bit 1 or Bit 2 is canceled.
	Action	(Command: "Fast stop" or "Inhibit voltage")
8	Event	Bit 0 is canceled (operation enabled -> ready for switch-on)
	Action	Output stage is switched off (disabled) motor has no torque.
9	Event	Bit 1 is canceled (operation enabled -> switch-on inhibited)
	Action	Output stage is switched off (disabled) motor has no torque.
10	Event	Bit 1 or 2 are canceled (ready for operation -> switch-on inhibited)
	Action	Output stage is switched off (disabled) motor has no torque.
11	Event	Bit 4 is canceled (operation enabled -> fast stop)
	Action	Drive is stopped, using the emergency ramp. The output stage remains enabled. Set-points are canceled (e.g motion block number, digital setpoint).
12	Event	Bit 1 is canceled (fast stop -> switch-on inhibited)
	Action	Output stage is switched off (disabled) motor has no torque.
13	Event	Error response active
	Action	Output stage is switched off (disabled) motor has no torque.
14	Event	Error
	Action	none
15	Event	Bit 7 is set (error -> switch-on inhibited)
	Action	Acknowledge error (depending on error – with/without reset)
16	Event	Bit 4 is set (fast stop -> operation enabled)
	Action	Motion function is enabled again.
17	Event	Bit 2 is canceled
	Action	Switch-on inhibited, output stage disabled

The state transitions are affected by internal events (e.g. switching off the DC-link voltage) and by the flags in the control word (Bits 0, 1, 2, 3, 7).

### 6.1.1 Control word (STW)

With the aid of the control word, you can switch from one amplifier state to another. In the diagram for the state machine you can see which instrument states can be reached by which transitions. The momentary amplifier state can be taken from the status word. Several states may be passed through during one telegram cycle, for example

Ready for switch on → Ready for operation → Operation enabled.

The bits in the control word can be (operating-) **mode-dependent** or **mode-independent**.

Bit	Name	Kommentar
0	Switch on	—
1	Inhibit voltage	—
2	Fast stop, switch-on inhibited	1 -> 0 drive decelerates using emergency ramp, axis is disabled (See also ASCII-commands STOPMODE and DECDIS)
3	Operation enabled	—
4	Fast stop (inhibit rfg)	1 -> 0 drive decelerates using emergency ramp
5	Pause (stop rfg)	Operating mode dependent, 1 -> 0 stops motion
6	Setpoint enable	Operating mode dependent (see table below)
7	Reset Fault	only effective with errors
8	Jogging (on/off)	Operating mode dependent (see table below)
9	reserved	—
10	PZD (enable/inhibit)	—
11	Start homing run (edge)	Operating mode dependent (see table below)
12	Manufacturer specific	reset the position
13	Manufacturer specific	acknowledge warnings
14	Manufacturer specific	position opmode only: <b>Bit14 = 1</b> : PZD section is interpreted as direct motion block (velocity 32-bit, position 32-bit, motion block type 16-bit) <b>Bit14 = 0</b> : PZD section (HSW) is interpreted as motion block no.
15	Manufacturer specific	depends on operating mode, digital speed

Depending on the bit combination in the control word, a corresponding control command is defined. The following table shows the bit combinations and also determines the priorities of the individual bits, in case several bits are altered in one telegram cycle.

Command	Bit 13	Bit 7	Bit 4	Bit 3	Bit 2	Bit 1	Bit 0	Transitions
Shutdown	x	x	x	x	1	1	0	2, 6, 8
Switch-on	x	x	x	x	1	1	1	3
Inhibit voltage	x	x	x	x	x	0	x	7, 9, 10, 12
Fast stop (amplifier is disabled)	x	x	x	x	0	1	x	7, 10, 11->12
Fast stop (amplifier remains enabled)	x	x	0	1	1	1	1	11
Inhibit operation	x	x	x	0	1	1	1	5
Enable operation	x	x	1	1	1	1	1	4, 16
Reset error	x	1	x	x	x	x	x	15
Acknowledge warnings	1	x	x	x	x	x	x	-

#### Opmode dependent bits in the control word:

Opmode	Bit 5	Bit 6	Bit 8	Bit 11
Position	Motion block: The parameter that is set in the motion block is used. Setup operation: The parameter that is set as a ramp for homing and jogging is used	Start a motion task with every transition edge (toggle bit).	Start jogging	Start homing
Digital speed	Drive brakes with preset speed ramp.	Setpoint enable	reserved	reserved
Digital current	reserved	Setpoint enable	reserved	reserved
Analog speed	reserved	reserved	reserved	reserved
Analog current	reserved	reserved	reserved	reserved
Trajectory	reserved	reserved	reserved	reserved

Priority of the Bits 6, 8, 11 in position-control mode: 6 (high), 11, 8 (low).

### 6.1.2 Status word (ZSW)

With the help of the status word, the amplifier state can be represented and a transmitted control word can be verified. If the amplifier does not react to changes of the control word (STW) as expected, the marginal conditions like (enable of the output stage – hardware + software, application of the DC bus link voltage) must be checked.

The bits in the status word can be mode-dependent or mode-independent. The following table describes the bit assignment in the status word.

Bit	Name	Comment
0	Ready for switch-on	---
1	Switched on	---
2	Operation enabled	---
3	Error	see ASCII command ERRCODE
4	Voltage inhibited	---
5	Fast stop	---
6	Switch-on inhibit	---
7	Warning	see ASCII command STATCODE
8	Setpoint / actual value monitoring	only in opmode position-control: following error indicator
9	Remote	not supported, fixed to 1
10	Setpoint reached	only in position mode: In Position
11	Limit active	not supported at present
12	Depends on mode	used in mode ASCII
13	Depends on mode	used in mode ASCII
14	Manufacturer specific	used in mode ASCII
15	Manufacturer specific	reserved

States of the status machine:

State	Bit 6	Bit 5	Bit 4	Bit 3	Bit 2	Bit 1	Bit 0
Not ready for switch-on	0	X	X	0	0	0	0
Switch-on inhibit	1	X	X	0	0	0	0
Ready for switch-on	0	1	X	0	0	0	1
Ready for operation	0	1	X	0	0	1	1
Operation enabled	0	1	X	0	1	1	1
Error	0	X	X	1	X	X	X
Error response	0	X	X	1	0	0	0
Fast stop active	0	0	X	0	1	1	1

## 6.2 Operating modes(Opmodes)

The selection of a new operating mode (→ # 24). This procedure must be followed for proper amplifier operation.

### NOTICE

Appropriate precautionary measures against damage caused by faulty presentation of data formats or normalization of the setpoints must be taken by the user.

The possible operating modes are described below. PROFIBUS operating modes with a positive number (1,2) are defined in the drive profile. Operating modes with a negative number (-1,-2...) are labeled in the drive profile as being manufacturer-specific modes.

## 6.2.1 Positioning (Opmode 2)

PZD 1	PZD 2	PZD 3	PZD 4	PZD 5	PZD 6
STW	motion task no. or vcmd*	-	-	-	-
ZSW	$n_{act}$ (16bit)	actual position (32bit)		manufacturerspecific status	-

\*: for jogging/homing

### Abweichende Belegung der Prozessdatenfelder bei STW Bit 14=1

PZD 1	PZD 2	PZD 3	PZD 4	PZD 5	PZD 6
STW	direct motion task: Vcmd (32 bit)		position setpoint (32bit)		motion block type
ZSW	$n_{act}$ (16 bit)	actual position (32bit)		manufacturer specific status	-

#### Motion task number

The motion task number of the motion task to be started can lie in the range 1 to 180 (motion tasks in EEPROM) or 192 to 255 (motion tasks in RAM).

#### Speed Setpoint (vcmd)

This is just when jogging or homing is selected. PNU 1894 provide the scaling for this value. More details (→ # 27)

#### Actual speed (16-bit)

The representation of the 16-bit actual speed value is normalized to the parameter for overspeed VOSPD:  $n_{act16} = n_{act}/VOSPD \times 2^{15}$

#### Actual position (32-bit)

The range for the incremental position covers values from  $-2^{31}$  to  $(2^{31}-1)$ , whereby one turn corresponds to  $2^{PRBASE}$  increments.

#### Manufacturer specific status

In the process data, the upper 16 bits of the manufacturer specific status register (PNU 1002) are made available. The numbering starts again from 0. Details of the status register bits (→ # 26).

#### Speed setpoint for a direct motion task

The usable range for the speed is not limited by the available data area. It is limited by the maximum achievable speed  $n_{max}$ , which is given by the speed parameter VLIM as the final limit speed for the motor. Maximum speed is derived from the following formula:

$$v_{Sl, max} = n_{max} \times PGEARI / PGEARO \times 2^{PRBASE} \text{ or, as an incremental value, from:}$$

$$v_{incr., max} = n_{max} \times 2^{PRBASE} \times 250\mu s/1s = n_{max} / 4000 \times 2^{PRBASE}, \text{ with } n_{max} \text{ in turns/sec}$$

#### Position setpoint for a direct motion task

The servo amplifier calculates all position values internally on an incremental basis only, so there are limitations on the usable range of values for distances that are given in SI (user) units.

The range for the incremental position covers the values from  $-2^{31}$  to  $(2^{31}-1)$ .

The resolution that is determined by the PGEARO (PNU1803) and PGEARI (PNU1802) parameters and the variable PRBASE fix the usable range for position values.

The variable PRBASE determines, through the equation  $n = 2^{PRBASE}$ , the number of increments per motor turn. The value of PRBASE can only be 16 or 20.

PGEARO contains the number of increments that must be traversed when the distance to be moved is PGEARI. The default values for PGEARO are 1048576 (PRBASE = 20) or 65536 (PRBASE = 16) and correspond to one turn. Number of turns that can be covered :

-2048..+2047 for PRBASE=20 and -32768..+32767 for PRBASE=16

The sensibly usable position range is derived as follows:

$-2^{31} \times PGEARI / PGEARO \dots (2^{31} - 1) \times PGEARI / PGEARO$  for  $PGEARI \leq PGEARO$  or

$-2^{31} \dots (2^{31} - 1)$  for  $PGEARI > PGEARO$ .

#### Motion block type

The various types of motion block (→ # 28)

## 6.2.2 Digital speed (Opmode 1)

PZD 1	PZD 2	PZD 3	PZD 4	PZD 5	PZD 6
STW	$n_{\text{cmd}}$	-	-	-	-
ZSW	$n_{\text{act}}$	-	incremental actual position 32 bit		manuf. specific status

Alternative assignment of the process data sections with STW Bit 14=1:

PZD 1	PZD 2	PZD 3	PZD 4	PZD 5	PZD 6
STW	$n_{\text{cmd}}$ (32 bit)	-	-	-	-
ZSW	$n_{\text{act}}$ (32 bit)	-	incremental actual position 32 bit		manuf. specific status

Alternative assignment of the process data sections with STW Bit 15=1:

PZD 1	PZD 2	PZD 3	PZD 4	PZD 5	PZD 6
STW	$n_{\text{cmd}}$	-	-	-	-
ZSW	$n_{\text{act}}$	-	position (20 bits/turn and 16 turns)		manuf. specific status

### Actual speed $n_{\text{act}}$ (16 Bit)

The representation of the 16-bit actual speed value is normalized to the parameter for the overspeed  $\text{VOSPD}$   $n_{\text{act}16} = n_{\text{act}} / \text{VOSPD} \times 2^{15}$

### Actual position (32 Bit)

The range for the incremental position covers values from  $-2^{31}$  to  $(2^{31}-1)$ . Here one turn corresponds to  $2^{\text{PRBASE}}$  increments.

### Manufacturer specific status

In the process data (PZD5), the upper 16 bits of the manufacturer specific status register (PNU 1002) are made available. The numbering starts again from 0.

The significance of the status register bits can be seen in the table in (→ # 26) .

### Speed setpoint $n_{\text{cmd}}$ (16 Bit)

The 16 bit speed setpoint is normalized to the parameter for the overspeed  $\text{VOSPD}$ .

$$\text{VOSPD } n_{\text{cmd}16} = n_{\text{soll}} / \text{VOSPD} \times 2^{15}$$

### Position

The actual position value is an incremental value with a resolution of 24 bits. Her one turn corresponds to  $2^{\text{PRBASE}}$  increments.

So  $2^{24-\text{PRBASE}}$  turns can be represented.

### Speed values $n_{\text{cmd}}$ (32 Bit)

The digital speed values are converted according to the formula.

$$n_{\text{cmd}/\text{act}} [\text{min}^{-1}] = (n_{\text{cmd}/\text{act, dig.}} \times 240,000) / 2^{32}$$

with 240,000 = number of position controller cycles / min

## 6.2.3 Analog speed (Opmode -1)

In this mode the control word (STW) can only be used to enable and disable the amplifier.

PZD 1	PZD 2	PZD 3	PZD 4	PZD 5	PZD 6
STW	-	-	-	-	-
ZSW	$n_{\text{act}}$	-	incremental actual position 32bit		manuf. specific status

### Actual speed $n_{\text{act}}$ (16 Bit)

The representation of the 16-bit actual speed value is normalized to the parameter for the overspeed  $\text{VOSPD}$   $n_{\text{act}16} = n_{\text{act}} / \text{VOSPD} \times 2^{15}$

### Actual position (32 Bit)

The range for the incremental position covers values from  $-2^{31}$  to  $(2^{31}-1)$ . Here one turn corresponds to  $2^{\text{PRBASE}}$  increments.

### 6.2.4 Digital torque (Opmode -2)

PZD 1	PZD 2	PZD 3	PZD 4	PZD 5	PZD 6
STW	$I_{cmd}$	-	-	-	-
ZSW	$I_{act} = IQ$	incremental actual position (32 bit, value range 24 bit)		manuf. specific status	-

#### Actual position (32 bit)

The range for the incremental position covers values from  $-2^{31}$  to  $(2^{31}-1)$ . Here one turn corresponds to  $2^{PRBASE}$  increments.

#### Manufacturer specific status

In the process data, the upper 16 bits of the manufacturer specific status register (PNU 1002) are made available. The numbering starts again from 0.

The significance of the status register bits can be seen in the table (→ # 26).

Digital current values (16 bit)

The digital current values are converted:

$I [mA] = \text{digital current setpoint} / 3280 \times \text{DIPEAK} [mA]$ , (DIPEAK = amplifier peak current)

### 6.2.5 Analog torque (Opmode -3)

In this mode the control word (STW) can only be used to enable and disable the amplifier.

PZD 1	PZD 2	PZD 3	PZD 4	PZD 5	PZD 6
STW	-	-	-	-	-
ZSW	$I_{act} = IQ$	incremental actual position (32 bit, value range 24 bit)		manuf. specific status	-

### 6.2.6 Electronic gearing (Opmode -4)

PZD 1	PZD 2	PZD 3	PZD 4	PZD 5	PZD 6
STW	-	-	-	-	-
ZSW	$n_{act}$	actual position (32 bit)		manuf. status	-

#### Actual speed (16 bit)

The representation of the 16 bit actual speed value is normalized to the parameter for the overspeed  $VOSPD$   $n_{act} = n_{act16} / VOSPD \times 2^{15}$

#### Actual position (32 bit)

The range for the actual position covers values from  $-2^{31}$  to  $(2^{31}-1)$ . Here one turn corresponds to  $2^{PRBASE}$  increments.

#### Manufacturer specific status

In the process data, the upper 16 bits of the manufacturer specific status register (PNU 1002) are made available. The numbering starts again from 0.

The significance of the status register bits can be seen in the table in (→ # 26).

### 6.2.7 Trajektory (Opmode -5)

In this mode the control word (STW) can only be used to enable and disable the amplifier.

PZD 1	PZD 2	PZD 3	PZD 4	PZD 5	PZD 6
STW	-	-	-	-	-
ZSW	$n_{act}$	Inkrementelle Istposition 32 Bit		Herstellerstatus	-

#### Actual speed (16 bit)

The representation of the 16 bit actual speed value is normalized to the parameter for the overspeed  $VOSPD$   $n_{act16} = n_{act} / VOSPD \times 2^{15}$

#### Actual position (32 bit)

The range for the actual position covers values from  $-2^{31}$  to  $(2^{31}-1)$ . Here one turn corresponds to  $2^{PRBASE}$  increments.



### 6.2.8 Digital speed & Servo Pump (Opmode -7)

PZD 1	PZD 2	PZD 3	PZD 4	PZD 5	PZD 6
STW	Pressure setpoint	Volume-flow setpoint	-	-	-
ZSW	Pressure actual value	Volume-flow actual value	Current actual value	Actual position Bits 16...32	Actual position Bits 0...15

The 16 bit values for pressure setpoints/actual pressure values are specified in 10 mBar steps. The 16 bit values for volume-flow setpoint/volume-flow actual value are specified in 0.1 l/min steps. When operating mode -7 is activated, QENA is automatically set to 1. When switching over to an operating mode other than -7, the servo pump is deactivated (QENA=0).

PNUs 1780...1820 see [ASCII Object Reference](#), group "Servo pump".

### 6.2.9 ASCII channel (Opmode -16)

PZD 1	PZD 2	PZD 3	PZD 4	PZD 5	PZD 6
STW	10 bytes of ASCII-data				
ZSW	10 bytes of ASCII-data				

The operating mode "ASCII-channel" is used for parameterizing the servo amplifier. With this channel, just as with any terminal program, ASCII data can be exchanged with the servo amplifier via the RS232 interface. The control of the communication is performed by handshake bits in the control and status words. The assignment is as follows:

#### Bit 12: Control word

Any transition edge on this bit informs the servo amplifier that valid ASCII data are available in its process data input section, i.e. that with effect from this moment valid data must have been entered into the PZD transmission section PZD 2 PZD 6 by the control system.

#### Bit 12: Status word

The servo amplifier confirms that it has accepted the ASCII data, by a transition edge on this bit.

#### Bit 13: Status word

The servo amplifier uses a "1" in this bit to signal that the ASCII buffer now contains valid data. A transition edge of Bit 14 in the control word STW can be used to make the servo amplifier write the buffer contents to the PZD reception section of the bus-master.

#### Bit 14: Control word

Any transition edge on this bit requests the servo amplifier to write the contents of its filled ASCII buffer to the receive process data of the bus master

#### Bit 14: Status word

The servo amplifier uses a transition edge on this bit to signal that the ASCII buffer data have been written to the process data.

#### When transmitting ASCII data, you must observe:

- Every ASCII command must be terminated by the "CR LF" character sequence.
- If the ASCII command (with CR LF) is shorter than the 10 characters that are available, then the rest of the telegram must be filled up with bytes with a content 0x00.
- ASCII commands that are longer than 10 characters must be divided into more than one telegram, where maximum 30 characters can be sent before the buffer must be read out once.

#### When evaluating the responses to the transmitted ASCII command, you must observe:

- The ASCII response is always terminated by an "End of Text" (EOT = 0x04) character.
- Response telegrams can include less than 10 bytes of user data, without the response being concluded. The telegram must then be filled up with bytes with the value 0x00.
- After reading out the buffer, Bit 13 of the status word is reset to "0", until the buffer is filled again. The designation of the end of the ASCII response is in all cases "End of Text".

### 6.2.10 Operating mode after switch-on (Opmode -126)

In this state, it is possible to control the state machine, but motion functions cannot be initiated (→ # 24).

## 7 Appendix

### 7.1 Setup examples for all servo amplifier models

#### 7.1.1 Zero telegram (for initialization)

At the beginning of PROFIBUS communication via the parameter channel and after communication errors, a zero telegram should be sent:

Byte 1	2	3	4	5	6	7	8
0000 0000	0000 0000	0000 0000	0000 0000	0000 0000	0000 0000	0000 0000	0000 0000
PKE		IND		PWE			

The servo amplifier answers, by likewise setting the first 8 byte of the telegram (PKW) to zero.

#### 7.1.2 Setting the Opmode

After switch-on or a reset (coldstart) the servo amplifier is in the PROFIBUS operating mode -126, in which it cannot perform any motion functions. For example to carry out positioning operations (motion tasks, jogging, homing), it must be set to the position-control mode.

The procedure to do this is as follows:

**a. Set the control word Bit 10 (PZD1, Bit 10) to 0. This invalidates the process data for the servo amplifier.**

Byte 9	10	11	12
xxxx x0xx	xxxx xxxx	xxxx xxxx	xxxx xxxx
STW		HSW	

**b. Transmit PNU 930 through the parameter channel to set the operating mode.**

Byte 1	2	3	4	5	6	7	8
0011 0011	1010 0010	xxxx xxxx	xxxx xxxx	0000 0000	0000 0000	0000 0000	0000 0010
PKE		IND		PWE			

The bits in the PKE section of the PKW have the following significance:

Bit 0 to 10 = PNU 930, Bit 12 to 15 = AK 3 (→ # 18)

The servo amplifier sends a response telegram with AK = 2 and mirrors (identical) the values for the PNU (parameter number) and PWE (parameter value).

**c. Switch on the new operating mode by setting the control word (STW) Bit 10 to 1. This validates the process data.**

If, for example, point a) is not observed, the servo amplifier transmits a negative answer: (response ID=7)

Byte 1	2	3	4	5	6	7	8
0111 0011	1010 0010	0000 0000	0000 0000	0000 0000	0000 0000	0000 0000	0001 0001
PKE		IND		PWE			

And the number that is transferred in the PWE section represents the error number (→ # 19). In this case, error no. 17, "Task impossible because of operating state" will be signaled.

#### 7.1.3 Enable the servo amplifier

The hardware enable signal (24V) must be applied, as a precondition for enabling the servo amplifier via the PROFINET. The enable through PROFIBUS can be made by setting the bit combination for the "Operation enabled" state in the control word (STW).

Byte 9	10	11	12
xxx0 x1xx	0011 1111	xxxx xxxx	xxxx xxxx
STW		HSW	

The servo amplifier then reports back the corresponding state in its status word (ZSW), or indicates a warning or error message.

Byte 9	10	11	12
xxxx xx1x	0010 0111	xxxx xxxx	xxxx xxxx
ZSW		HSW	

### 7.1.4 Start jog mode (on positioning opmode)

Jog mode is started in a similar manner to homing. To start, Bit 8 STW must be set. The jog velocity is given by the product of the 16-bit main setpoint in PZD2 and the multiplier defined by PNU 1894. The sign of the main setpoint determines the direction of movement.

It is not necessary to have a reference point set for jogging.

### 7.1.5 Set reference point

#### NOTICE

Take care that the position of the reference point permits the following positioning operations. The parameterized software limit-switches in the servo amplifier may not be effective. The axis could then drive up to the hardware limit-switch or the mechanical stop. There is a danger of damage being caused.

The control word (STW) Bit 12 = 1 defines the present position as being the reference point. The positioning functions are enabled. **The shifting of the zero point (NI-offset) is ineffective.**

The replay "Reference point set" is made through Bit 17 in the manufacturer-specific status register (PNU 1002) or Bit 1 (manufacturer status of the process data).

#### Condition:

PNU930 ≠ -16

No motion function active manufacturer specific status, process data 5 bit 0.

### 7.1.6 Start homing run

#### NOTICE

After switching on the 24V auxiliary voltage the system must first of all carry out a homing run. Take care that the position of the machine zero point (reference point) permits the following positioning operations. The parameterized software limit-switches in the servo amplifier may not be effective. The axis could then drive up to the hardware limit-switch or the mechanical stop. There is a danger of damage being caused.

If the reference point (machine zero point) is approached too fast, with high moments of inertia in the system, then it might be overrun, and the axis could then drive up to the hardware limit-switch or the mechanical stop. There is a danger of damage being caused.

The homing run is started by the control word (STW) Bit 11 = 1. The start of the homing run is detected by a positive transition edge for Bit 11.

If Bit 11 is set to 0 again, before the reference point has been reached, then the homing run is canceled. Status word (ZSW) Bit 17 remains at 0 (reference point not set).

A set reference point is a precondition for all the positioning functions of the linear axis. The reference point switch is wired up to a digital input on the servo amplifier.

Depending on the type of homing run, you can freely shift the zero crossing point of the motor shaft within one turn, by using the parameter "Zero-point offset" (NI-offset). Furthermore, you can fix the position value to be the reference point by using the reference offset.

After the homing run, the amplifier signals "InPosition", thereby enabling the position controller. The velocity for the homing run is transmitted with the setpoint HSW (PZD 2), as a 16-bit value. Multiplying this by the value of PNU 1894 determines the 32-bit speed. The sign is not evaluated.

#### Conditions :

State of the state machine = "Operation enabled" No warning message (ZSW Bit 7 = 0)

The following diagram uses the homing run Type 1 (negative direction of motion, positive rotation, starting point in negative direction relative to the reference switch) as an example to illustrate the signal sequence of the relevant bits in the manufacturer-specific state.

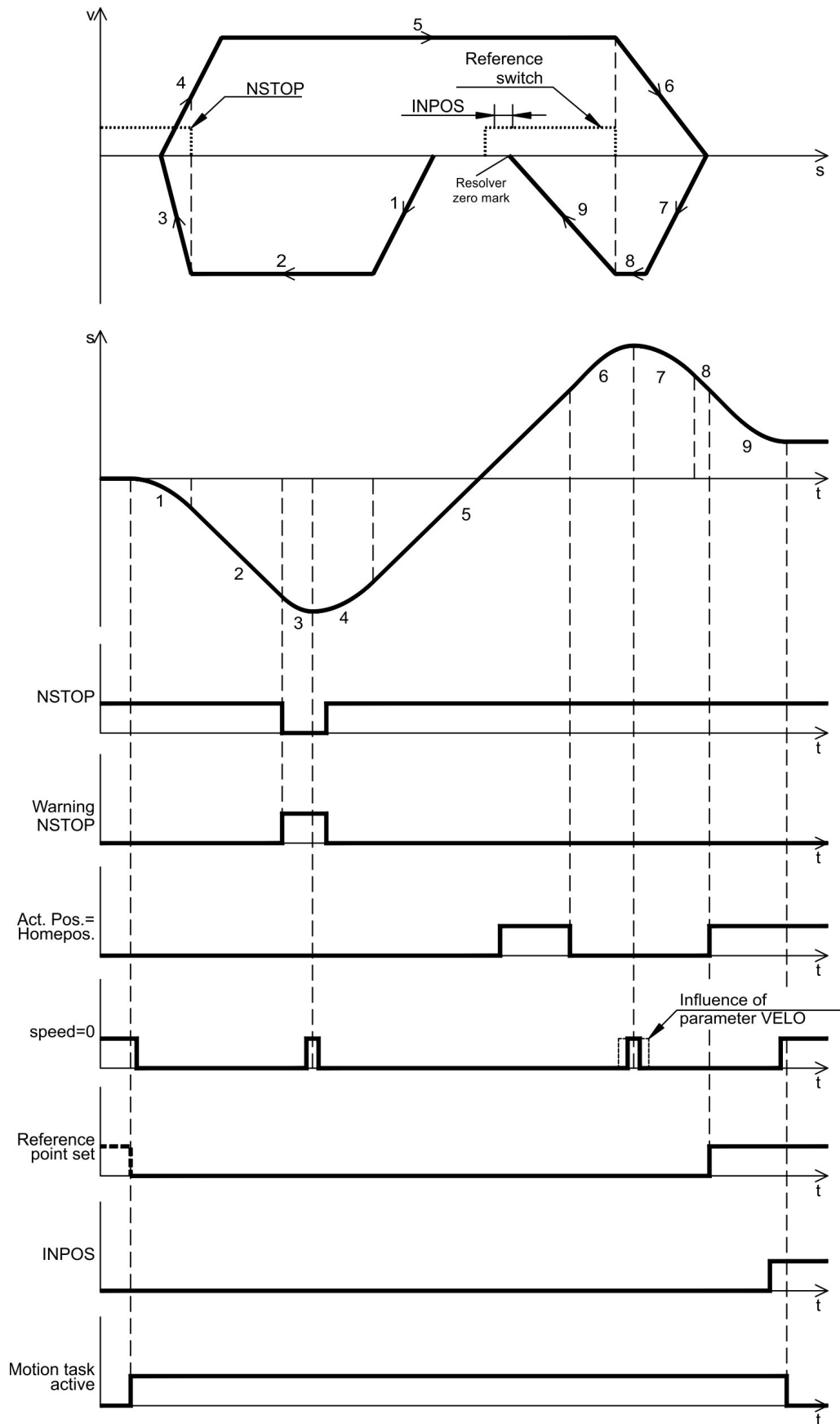

After the homing run has been completed, Bit 11 STW must be set to 0 again.

Alternatively, the reference point can also be set at the actual position. This can be achieved by setting Bit 12 STW, or by setting the homing run type 0 with PNU 1773 and subsequent start of the homing run by Bit 11 STW .

### 7.1.7 Start a motion task

Motion tasks are started by a transition edge (positive or negative) at Bit 6 STW. Bit 14 STW is used to decide whether a stored motion task or a direct motion task should be carried out.

#### Conditions:

- Hardware enable is present.
- Amplifier is in the "Operation enabled" state.
- For linear axis: reference point is set.

Example: start the EEPROM motion task number 10:

Byte 9	10	11	12
0000 0100	0F*11 1111	0000 0000	0000 1010
STW		HSW	

\* F stands for a transition edge, the state of Bit 6 STW also depends on the previous state.

By setting bit 5 in the manufacturer specific status, the amplifier indicates that it has accepted the motion task and is carrying it out.

### 7.1.8 Start a direct motion task

If the motion task data is to be directly sent from the controller, then a direct motion task must be used. In this case, the target position, velocity and type of motion task are transferred using the process data channel (PZD), together with the call of the motion task. If required, further parameters for this motion task (e.g. ramps) can be transferred previously by parameter tasks.

Target position	35000 $\mu\text{m}$
Velocity	20000 mm/s
Motion task type	<ul style="list-style-type: none"> <li>- relative to actual position</li> <li>- with following motion task without pause</li> <li>- target velocity for the following task should already be reached at the target position (only makes sense if there is no change of direction)</li> <li>- use SI (user) units</li> </ul>

Byte 1	2	3	4	5	6
0100 0100	0F*11 1111	0000 0000	0000 0000	0100 1110	0010 0000
PZD1		PZD2		PZD3	
STW		velocity setpoint			
Byte 7	8	9	10	11	12
0000 0000	0000 0010	0000 1111	0101 1000	0010 0001	0001 1101
PZD4		PZD5		PZD6	
position setpoint				motion task type	

\* F stands for a transition edge, the state of Bit 6 STW also depends on the previous state.

### 7.1.9 Polling a warning or error message

If a warning or error message is present, then parameter 1001 or 1002 can be interrogated to find out the number of the warning or error.

### 7.1.10 Writing a parameter via parameter channel

Parameter  $v_{\text{max}}$  is used as an example to show how control parameters are transmitted from the master to the servo amplifier.

Parameter number:	<b>1816</b>	111 0001 1000
Parameter value:	<b>350000 <math>\mu\text{m/s}</math></b>	0000 0000 0000 0101 0101 0111 0011 0000

Byte 1	2	3	4	5	6	7	8
0011 0111	0001 1000	0000 0100	0000 0000	0000 0000	0000 0101	0101 0111	0011 0000
PKE		IND		PWE			

Note: After an error has occurred in parameter transmission ( $AK = 7$ ), a "Zero telegram" should be transmitted, i.e. the first 8 bytes of the transmit telegram from the PLC should be kept at 0, until the servo amplifier has responded with a zero telegram.

### 7.1.11 Reading actual values

#### Cyclical actual value request

This PKW task switches on the reading of an actual value. The actual value will now be transmitted with each cyclical telegram – until a new PKW task is presented.

#### Telegram layout:

	Request	Response
PKE/AK	1	2
PKE/PNU	Parameter number of the actual values	as transmitted
IND	0 =read	0
PWE	no significance	actual value

### 7.1.12 Write a parameter via the ASCII channel

The KP value for the current controller is to be set through the ASCII channel. The command is then **MLGQ\_1.985**. Here the understroke stands for a space. Since every telegram only has 10 positions available for the transmission of ASCII characters, the termination of the line ("CR LF") must be transmitted in a second telegram.

#### Conditions:

- ASCII mode is switched on (PNU 930 = -16)
- Bit 13 STW = 0 (if necessary, toggle Bit 14 STW until Bit 13 ZSW = 0)

#### Procedure:

##### 1. Write data to PZD 2..6 and invert Bit 12 STW

Byte 1	2	3	4	5	6
0001 0000	0000 0000	0100 1101	0100 1100	0100 0111	0101 0001
PZD1		PZD2		PZD3	
STW		"M"	"L"	"G"	"Q"

Byte 7	8	9	10	11	12
0010 0000	0011 0001	0010 1110	0011 1001	0011 1000	0011 0101
PZD4		PZD5		PZD6	
"_"	"1"	"."	"9"	"8"	"5"

##### 2. Wait for the transition edge on Bit 12 ZSW

##### 3. Continue writing data to PZD 2...6 and invert Bit 12 STW

Byte 1	2	3	4	5...12
0000 0000	0000 0000	0000 1101	0000 1010	0000 0000
PZD1		PZD2		PZD3..6
STW		"CR"	"LF"	

##### 4. Wait for the transition edge on Bit 12 ZSW

##### 5. Wait until Bit 13 ZSW = 1

##### 6. Invert Bit 14 STW

##### 7. Wait until Bit 14 ZSW = 1

##### 8. The servo amplifier sends a response telegram

Byte 1	2	3	4	5	6
0110 0010	0000 0000	0100 1101	0100 1100	0100 0111	0101 0001
PZD1		PZD2		PZD3	
ZSW		"M"	"L"	"G"	"Q"

Byte 7	8	9	10	11	12
0010 0000	0011 0001	0010 1110	0011 1001	0011 1000	0011 0101
PZD4		PZD5		PZD6	
"_"	"1"	"."	"9"	"8"	"5"

##### 9. Repeat steps 5 to 8 until a response telegram indicates "EOT".

Byte 1	2	3	4	5	6	7...12
0000 0010	0000 0000	0000 1101	0000 1010	0000 0100	0000 0000	0000 0000
PZD1		PZD2		PZD3		PZD4..6
ZSW		"CR"	"LF"	"EOT"		

**Note:** The sequence of response telegrams shown above is only one of many possibilities (for the same response from the servo amplifier). Because of the transmission rate and the internal synchronization mechanism, it can happen that process data sections remain empty and so the response is broken into segments. This could possibly alter the number of response telegrams.

--- / ---



## 7.2 Index

### A

Actual values .....	29
Analog I/O .....	30
Analog speed .....	39
Analog torque .....	40
ASCII channel .....	41

### C

Control word (STW) .....	36
--------------------------	----

### D

Device profile .....	17
Digital I/O .....	30
Digital speed .....	39
Digital torque .....	40

### E

Electronic gearing .....	40
Error numbers .....	19
Expansion Card .....	9

### I

Important amplifier configuration parameters .....	12
Index IND .....	19
Installation .....	8
Instrument control .....	34
Instrument ID .....	25

### M

Manufacturer specific error register .....	25
Manufacturer specific parameters .....	25
Manufacturer specific status register .....	26
Mounting .....	8

### O

Operating mode after switch-on .....	41
Operating modes .....	37
Opmode -1 .....	39
Opmode -126 .....	41
Opmode -16 .....	41
Opmode -2 .....	40
Opmode -3 .....	40
Opmode -4 .....	40
Opmode -5 .....	40
Opmode -7 .....	41
Opmode 1 .....	39
Opmode 2 .....	38
Opmodes .....	37

### P

Parameter channel (PKW) .....	21
Parameter ID (PKE) .....	18
Parameter numbers .....	21
Parameter value PWE .....	20
PNU 1000 .....	25

PNU 1001 .....	25
PNU 1002 .....	26
PNU 1310 .....	29
PNU 1600ff .....	31
PNU 1607 .....	30
PNU 1644 .....	29
PNU 1698/1701/1704/1707 .....	30
PNU 1773 .....	29
PNU 1775/1778 .....	30
PNU 1783 .....	28
PNU 1785 .....	28
PNU 1786 .....	29
PNU 1788 .....	29
PNU 1789 .....	29
PNU 1790 .....	27
PNU 1791 .....	27
PNU 1800 .....	29
PNU 1807 .....	27
PNU 1894 .....	27
PNU 930 .....	24
PNU 970 .....	24
PNU 971 .....	24
Position control parameters .....	27
Position data for the position control mode .....	27
Positioning .....	38
Process data channel .....	33
Profile Parameters .....	24

### R

Read/write an amplifier parameter .....	21
Response IDs .....	18

### S

Servo Pump .....	41
Setup .....	11
Setup examples .....	42
Setup mode Position .....	29
Setup Software .....	15
Status word (ZSW) .....	37
Symbols used .....	6

### T

Target group .....	5
Trajektorij .....	40

### U

Use as directed .....	6
-----------------------	---

## Service

We are committed to quality customer service. In order to serve in the most effective way, please contact your local sales representative for assistance.

If you are unaware of your local sales representative, please contact the Customer Support.



Join the [Kollmorgen Developer Network](#) for product support. Ask questions to the community, search the knowledge base, download files and make suggestions for improvement.



### Europe

KOLLMORGEN

Internet: [www.kollmorgen.com/en-us](http://www.kollmorgen.com/en-us)

E-Mail: [technik@kollmorgen.com](mailto:technik@kollmorgen.com)

Tel.: +49 - 2102 - 9394 - 0

Fax: +49 - 2102 - 9394 - 3155



### North America

KOLLMORGEN

Internet: [www.kollmorgen.com/en-us](http://www.kollmorgen.com/en-us)

E-Mail: [support@kollmorgen.com](mailto:support@kollmorgen.com)

Tel.: +1 - 540 - 633 - 3545

Fax: +1 - 540 - 639 - 4162



### South America

KOLLMORGEN

Internet: [www.kollmorgen.com/pt-br](http://www.kollmorgen.com/pt-br)

E-Mail: [contato@kollmorgen.com](mailto:contato@kollmorgen.com)

Tel.: +55 - 11 - 4615-6300



### Asia

KOLLMORGEN

Internet: [www.kollmorgen.cn](http://www.kollmorgen.cn)

E-Mail: [sales.china@kollmorgen.com](mailto:sales.china@kollmorgen.com)

Tel: +86 - 400 668 2802

Fax: +86 - 21 6248 5367

