

sercos[®] II

Fieldbus Interface for SERVOSTAR[®] 400/600



sercos
the automation bus

Edition 04/2016
Translation of the original manual

Keep the manual as a product component
during the life span of the product.
Pass the manual to future users / owners
of the product.

KOLLMORGEN[®]

Record of revisions :

Date (Edition)	Remarks
03/2002	First valid edition
09/2002	Layout changed, new IDNs 3028, 3050, 3051, translation quality optimized
12/2005	Contents completely updated, valid for all SERVOSTAR types
01/2006	Some corrections, additional information for IDN 134/135
09/2006	New Design
09/2007	New IDNs, S300 removed, additional hints, branding, appendix extended
11/2007	Chapter Macro-Variables removed
12/2008	IDNP3009 new, some corrections
12/2009	Product brand, minor corrections, symbols acc. to ANSI Z535
12/2010	New company name
07/2014	Sercos Logo new, design cover page, warning notes
04/2016	Warning signs updated, european directives updated, safe voltage changed to 50V

SERVOSTAR is a registered trademark of Kollmorgen Corporation
sercos® is a registered trademark of sercos® International e.V.

Technical changes which improve the performance of the equipment may be made without prior notice !

All rights reserved. No part of this work may be reproduced in any form (by photocopying, microfilm or any other method) or stored, processed, copied or distributed by electronic means without the written permission of Kollmorgen Europe GmbH.

1	General Information	
1.1	About this manual	9
1.2	Target group	9
1.3	Hints for the online edition (PDF format)	9
1.4	Use as directed	10
1.5	Symbols used	10
1.6	Abbreviations used	10
2	Installation / Setup	
2.1	Assembly / Installation	11
2.1.1	Installing the expansion card (S600 only)	12
2.1.2	Front view	12
2.1.3	LEDs	12
2.1.4	Connection technology	12
2.1.5	Connection diagram	13
2.1.6	Modifying the station address	13
2.1.7	Modifying the baud rate and optical power	13
2.2	Setup	14
2.2.1	Guide to setup	14
2.2.2	Setup Software	15
2.2.2.1	Screen page "SERCOS"	15
2.2.2.2	Screen page "SERCOS SERVICE"	16
3	SERCOS IDN Set	
3.1	MDT Control Word, Bits 13 - 15	17
3.2	IDN Format	18
3.3	IDN1 Control Unit Cycle Time (t_{Ncyc})	20
3.4	IDN2 Communication Cycle Time (t_{Scyc})	20
3.5	IDN3 Shortest AT Transmission Starting Time (t_{1min})	20
3.6	IDN4 Transmit/Receive Transition Time (t_{ATMT})	20
3.7	IDN5 Minimum Feedback Processing Time (t_5)	21
3.8	IDN6 AT Transmission Starting Time (t_1)	21
3.9	IDN7 Feedback Acquisition Capture Point (t_4)	21
3.10	IDN8 Command Value Valid Time (t_3)	21
3.11	IDN9 Position of Data Record in MDT	22
3.12	IDN10 Length of MDT	22
3.13	IDN11 Class 1 Diagnostic (C1D)	22
3.14	IDN12 Class 2 Diagnostic (C2D)	23
3.15	IDN13 Class 3 Diagnostic (C3D)	23
3.16	IDN14 Interface Status	24
3.17	IDN15 Telegram Type Parameter	25
3.18	IDN16 Configuration List of AT Cyclic Data	25
3.19	IDN17 IDN List of All Operation Data	25
3.20	IDN18 IDN List of Operation Data for CP2	26
3.21	IDN19 IDN List of Operation Data for CP3	26
3.22	IDN21 IDN List of Invalid Operation Data for CP2	26
3.23	IDN22 IDN List of Invalid Operation Data for CP3	26
3.24	IDN24 Configuration List of MDT Cyclic Data	26
3.25	IDN25 IDN List of All Procedure Commands	27
3.26	IDN28 MST Error Counter	27
3.27	IDN29 MDT Error Counter	27
3.28	IDN30 Manufacturer Version	27
3.29	IDN32 Primary Operation Mode	28
3.30	IDN33 Secondary Operation Mode 1	28
3.31	IDN36 Velocity Setpoint Value	29
3.32	IDN38 Positive Velocity Limit Value	29
3.33	IDN39 Negative Velocity Limit Value	29
3.34	IDN40 Velocity Feedback Value	29
3.35	IDN41 Homing Velocity	30
3.36	IDN42 Homing Acceleration	30
3.37	IDN43 Velocity Polarity Parameter	30

	page	
3.38	IDN44 Velocity Data Scaling Type	31
3.39	IDN45 Velocity Data Scaling Factor	31
3.40	IDN46 Velocity Data Scaling Exponent	31
3.41	IDN47 Position Setpoint Value	32
3.42	IDN49 Positive Position Limit	32
3.43	IDN50 Negative Position Limit	32
3.44	IDN51 Position Feedback Value 1 (Motor Feedback)	32
3.45	IDN52 Reference Distance 1 (Motor Feedback)	33
3.46	IDN53 Position Feedback Value 2 (External Feedback)	33
3.47	IDN54 Reference Distance 2 (External Feedback)	33
3.48	IDN55 Position Polarity Parameter	34
3.49	IDN57 Position Window	34
3.50	IDN59 Position Switch Flag Parameter	35
3.51	IDN60..67 Position Switch Point 1..8	35
3.52	IDN76 Position Data Scaling Type	36
3.53	IDN77 Linear Position Data Scaling Factor	37
3.54	IDN78 Linear Position Data Scaling Exponent	37
3.55	IDN79 Rotational Position Resolution	37
3.56	IDN80 Torque Setpoint Value	37
3.57	IDN81 Additive Torque Setpoint	38
3.58	IDN84 Torque Feedback Value	38
3.59	IDN86 Torque/Force Data Scaling Type	38
3.60	IDN88 Receive to Receive Recovery Time	38
3.61	IDN89 MDT Transmission Starting Time	39
3.62	IDN90 Setpoint Value Processing Time	39
3.63	IDN91 Bipolar Velocity Limit	39
3.64	IDN92 Bipolar Torque Limit	40
3.65	IDN93 Scaling Factor Torque	40
3.66	IDN94 Scaling Exponent Torque	40
3.67	IDN95 Diagnostic Message	40
3.68	IDN96 Slave Arrangement	40
3.69	IDN97 Class 2 Diagnostic Mask	41
3.70	IDN98 Class 3 Diagnostic Mask	41
3.71	IDN99 Command: Reset Class 1 Diagnostic (clear fault)	41
3.72	IDN100 Velocity Loop Proportional Gain	42
3.73	IDN101 Velocity Loop Integral Action Time	42
3.74	IDN103 Modulo Value	42
3.75	IDN104 Position Loop Proportional Gain	42
3.76	IDN105 Position Loop Integral Action Time	43
3.77	IDN106 Current Loop Proportional Gain 1	43
3.78	IDN107 Current Loop Integral Action Time 1	43
3.79	IDN108 Feedrate Override	43
3.80	IDN109 Motor Peak Current	43
3.81	IDN110 Amplifier Peak Current	44
3.82	IDN111 Motor Continuous Stall Current	44
3.83	IDN112 Amplifier Rated Current	44
3.84	IDN113 Maximum Motor Speed	44
3.85	IDN114 System Load Limit	44
3.86	IDN116 Resolution of Rotational Feedback 1 (Motor Feedback)	45
3.87	IDN117 Resolution of Rotational Feedback 2 (External Feedback)	45
3.88	IDN119 Current Loop Proportional Gain 2	45
3.89	IDN120 Current Loop Integral Action Time 2	45
3.90	IDN121 Input Revolutions of Load Gear	46
3.91	IDN122 Output Revolutions of Load Gear	46
3.92	IDN123 Feed Constant	46
3.93	IDN126 Torque treshold Tx	46
3.94	IDN127 Command: Communication Phase 3 Transition Check	47
3.95	IDN128 Command: Communication Phase 4 Transition Check	47
3.96	IDN129 Manufacturer Class 1 Diagnostic (MC1D)	47
3.97	IDN130 Probe 1 Positive Edge Value	48

	page
3.98 IDN131 Probe 1 Negative Edge Value	48
3.99 IDN132 Probe 2 Positive Edge Value	48
3.100 IDN133 Probe 2 Negative Edge Value	48
3.101 IDN134 Master Control Word	49
3.102 IDN135 Amplifier Status Word	50
3.103 IDN136 Positive Acceleration Limit Value	51
3.104 IDN137 Negative Acceleration Limit Value.	51
3.105 IDN138 Bipolar Acceleration Limit Value	51
3.106 IDN140 Controller Type	51
3.107 IDN141 Motor Type	52
3.108 IDN142 Application Type	52
3.109 IDN143 System Interface Version	52
3.110 IDN146 Command: NC-Controlled Homing	52
3.111 IDN147 Homing Parameter	53
3.112 IDN148 Command: Amplifier-Controlled Homing.	53
3.113 IDN159 Monitoring Window	54
3.114 IDN160 Acceleration Data Scaling Type	54
3.115 IDN161 Acceleration Data Scaling Factor	54
3.116 IDN162 Acceleration Data Scaling Exponent.	55
3.117 IDN169 Probe Control Parameter	55
3.118 IDN170 Command: Probing	56
3.119 IDN179 Probe Position Latch Status	56
3.120 IDN181 Manufacturer Class 2 Diagnostic (MC2D).	57
3.121 IDN182 Manufacturer Class 3 Diagnostic (MC3D).	57
3.122 IDN185 Maximum Length of AT Configurable Data	57
3.123 IDN186 Maximum Length of MDT Configurable Data	57
3.124 IDN187 List of AT Configurable Data IDNs	58
3.125 IDN188 List of MDT Configurable Data IDNs.	58
3.126 IDN189 Following Distance	59
3.127 IDN192 IDN List of Back-up Operation Data	59
3.128 IDN196 Motor Rated Current	59
3.129 IDN197 Command; Set coordinate system	59
3.130 IDN203 Amplifier Shutdown Temperature	59
3.131 IDN205 Cooling Error Shutdown Temperature.	60
3.132 IDN208 Temperature Data Scaling Type	60
3.133 IDN256 Multiplication Factor 1	60
3.134 IDN257 Multiplication Factor 2	60
3.135 IDN262 Command: Load Default Values	61
3.136 IDN264 Command: Back-up Working Memory	61
3.137 IDN271 Amplifier ID	61
3.138 IDN288 IDN List of Data Programmable in CP2.	61
3.139 IDN289 IDN List of Data Programmable in CP3.	62
3.140 IDN296 Velocity Feed-Forward Gain	62
3.141 IDN298 Home Switch Distance	62
3.142 IDN301 Allocation of Real-time Control Bit 1	63
3.143 IDN303 Allocation of Real-time Control Bit 2	63
3.144 IDN304 Real-Time Status Bit 1	63
3.145 IDN305 Allocation of Real-time Status Bit 1	64
3.146 IDN306 Real-Time Status Bit 2	64
3.147 IDN307 Allocation of Real-time Status Bit 2	64
3.148 IDN312 Temperature Warning Motor Status	64
3.149 IDN323 Status "Target position outside of travel range"	65
3.150 IDN336 Status "In Position"	65
3.151 IDN347 Velocity Control Deviation.	65
3.152 IDN348 Gain for Acceleration Feed Forward	65
3.153 IDN376 Supported Baud Rate	65
3.154 IDN380 DC Bus Link Voltage.	66
3.155 IDN384 Amplifier Temperature.	66
3.156 IDN392 Velocity Feedback Filter Time Constant	66
3.157 IDN400 Home Switch Status	66

3.158	IDN401 Probe 1 Status	66
3.159	IDN402 Probe 2 Status	67
3.160	IDN403 Position Feedback Value Status	67
3.161	IDN405 Probe 1 Enable	67
3.162	IDN406 Probe 2 Enable	67
3.163	IDN409 Probe 1 Positive Edge Latched Status	68
3.164	IDN410 Probe 1 Negative Edge Latched Status	68
3.165	IDN411 Probe 2 Positive Edge Latched Status	68
3.166	IDN412 Probe 2 Negative Edge Latched Status	69
3.167	IDN447 Command: Sete absolute position	69
3.168	IDNP3000..3003 (35 768..35 771) Digital Input 1..4 Configuration	69
3.169	IDNP3004 (35 772) Position Switch Configuration	69
3.170	IDNP3005/3006 (35 773 / 35 774) Digital Output 1..2 Configuration	70
3.171	IDNP3007/3008 (35 775 / 35 776) Digital Output Trigger	70
3.172	IDNP3009 (35 777) Release Motor Brake	70
3.173	IDNP3010 (35 778) Feedback Type	71
3.174	IDNP3011 (35 779) Encoder Emulation Configuration	71
3.175	IDNP3012 (35780) Difference Probe Edge Value 1	72
3.176	IDNP3013 (35781) Difference Probe Edge Value 2	72
3.177	IDNP3014 (35782) Probe Difference Control Parameter	73
3.178	IDNP3015 (35 783) Hardware Limit Switch Consequence	75
3.179	IDNP3016 (35 784) Reset Command Consequence: prevent cold start	75
3.180	IDNP3017 (35 785) Position Feedback Type	76
3.181	IDNP3018 (35 786) Configuration of the Position latch	76
3.182	IDNP3019 (35 787) Selection of the FPGA Program	77
3.183	IDNP3020 (35 788) System Rated Current	77
3.184	IDNP3021 (35 789) Over Speed	77
3.185	IDNP3022 (35 790) Emergency Stop Rate	77
3.186	IDNP3023 (35 791) 2nd Filter Time Constant Velocity Control	78
3.187	IDNP3024 (35 792) Proportional Gain Velocity Control	78
3.188	IDNP3025 (35 793) Command DIR	78
3.189	IDNP3026 (35 794) Non-Volatile Memory Data Checksum	78
3.190	IDNP3027 (35 795) Manufacturer Homing Modes	79
3.191	IDNP3028 (35 796) Output stage enable order	80
3.192	IDNP3030..3033 (35 798..35 801) Digital Input 1...4	80
3.193	IDNP3034/3035 (35 802/35 803) Analog Input Value 1...2	80
3.194	IDNP3036/3037 (35 804/35 805) Digital Output 1...2	80
3.195	IDNP3038 (35 806) Probe 1 and 2 Enable	80
3.196	IDNP3039 (35 807) Probe 1 and 2 Control Parameter	81
3.197	IDNP3040 (35 808) Spline Interpolation Method	81
3.198	IDNP3041 (35 809) Position Switch On/Off Parameter	81
3.199	IDNP3042 (35 810) Position Switch Enable/Disable Parameter	81
3.200	IDNP3043 (35 811) Position Switch Polarity Parameter	82
3.201	IDNP3044 (35 812) Type of Position Switch Parameter	83
3.202	IDNP3045 (35813) Integral Current Component	83
3.203	IDNP3046 (35814) Motor Number	83
3.204	IDNP3047 (35 815) Configuration of Digital Cams	83
3.205	IDNP3048/3049 (35 816/35 817) Correction Values for Digital Cams 1..2 and 3..4	84
3.206	IDNP3050/3051 (35 818/35 819) Analog Output 1..2 Value	84
3.207	IDNP3052 (35 820) Switch for Acceleration Feed Forward	84
3.208	IDNP3053 (35 821) Cyclic Command Value	84
3.209	IDNP3054 (35 822) Cyclic Actual Value	84
3.210	IDNP3057 (35 825) Off Switch for Digital Cams 1..2	85
3.211	IDNP3058 (35 826) Off Switch for Digital Cams 3..4	85
3.212	IDNP3060 (35 828) Counter for RDIST - Receive Noise	85

4	Appendix	
4.1	ASCII Reference List	87
4.2		89
4.3	Limit Switch Hardware and Software	89
4.4	Scalings	90
4.4.1	Position	90
4.4.2	Speed	90
4.4.3	Power / Torque	90
4.4.4	Unit conversion, example	91
4.5	Simple basic configuration, example	91
4.5.1	Position control	91
4.5.2	Speed control	92
4.5.3	Torque control	92
4.6	Real-time bits	93
4.7	Homing	94
4.7.1	Drive-controlled	94
4.7.2	Control system-controlled	96
4.8	Cam-Switch	97
4.9	Linearaxes	98
4.10	Directions of rotation	98
4.11	External position control	99
4.12	Quadratic interpolation	100
4.13	Gearing and transmission ratios for linear and rotational axes	101
4.14	Troubleshooting	102
4.14.1	When does F29 occur?	102
4.14.2	Phase 0 or phase 1 is not possible	102
4.14.3	It is not possible to switch up from phase 2 to phase 3	102
4.14.4	It is not possible to switch up from phase 3 to phase 4	103
4.15	IDN type-sorted	104
4.15.1	General	104
4.15.2	Acceleration / Deceleration Control	105
4.15.3	Torque Control	105
4.15.4	Fault & Safety Detection	106
4.15.5	Feedback Devices	106
4.15.6	Velocity Control	107
4.15.7	Monitoring & Troubleshooting	107
4.15.8	Configurable I/O	108
4.15.9	Position Control	109
4.15.10	Motor Compatibility	110
4.15.11	System Communication	110

This page has been deliberately left blank.

1 General Information

1.1 About this manual

This manual describes the installation, setup, range of functions and software protocol of the SERCOS interface for SERVOSTAR 400 (S400) and SERVOSTAR 600 (S600) servo amplifiers and a reference for all IDN which are used by these servo amplifiers.

SERVOSTAR 600:

The expansion card SERCOS offers **sercos*** compatible Fiber Optic Cable (FOC) connectivity to these servo amplifiers.

SERVOSTAR 400-SE:

SERCOS functionality is built-in on delivery.

This manual forms part of the complete documentation for the SERVOSTAR 400 and SERVOSTAR 600 families of servo amplifiers.

The installation and setup of the servo amplifiers, as well as all standard functions, are described in the corresponding instructions manuals.

Other parts of the complete documentation for the digital servo amplifier series:

<u>Title</u>	<u>Publisher</u>
Instructions manual for the servo amplifier	Kollmorgen
Online Help in the setup software with ASCII Object Reference	Kollmorgen

* sercos is written in upper case in this documentation

1.2 Target group

This manual addresses personnel with the following qualifications:

Transport : only by personnel with knowledge of handling electrostatically sensitive components.

Unpacking: only by electrically qualified personnel.

Installation : only by electrically qualified personnel.

Setup : only by qualified personnel with extensive knowledge of electrical engineering and drive technology

Programming: Software developers, SERCOS project-planners

The qualified personnel must know and observe the following standards:

IEC 60364, IEC 60664 and accident prevention regulations



Qualified Personnel only!

During operation there are deadly hazards, with the possibility of death, severe injury or material damage.

- The user must ensure that the safety instructions in this manual are followed.
- The user must ensure that all personnel responsible for working with the servo amplifier have read and understood the instructions manual.

Training courses are available on request.

1.3 Hints for the online edition (PDF format)

Bookmarks: Table of contents and index are active bookmarks.

Table of contents and index in the text: The lines are active cross references. Click on the desired line and the appropriate page is accessed.

Page/chapter numbers in the text: Page/chapter numbers with cross references are active. Click at the page/chapter number to reach the indicated target.

1.4 Use as directed

Please observe the chapter "Use as directed" in the instructions manual for the servo amplifier. The SERCOS interface serves only for the connection of the servo amplifier to a master with SERCOS Fiber Optic Cable (FOC) connectivity.







The servo amplifiers are components that are built into electrical apparatus or machinery, and can only be setup and operated as integral components of such apparatus or machinery.

INFO

We can only guarantee the conformity of the servo amplifier with the following standards for industrial areas when the components that we specify are used, and the installation regulations are followed:

EC EMC Directive 2014/30/EEC
EC Low-Voltage Directive 2014/35/EEC

1.5 Symbols used

Symbol	Indication
 DANGER	Indicates a hazardous situation which, if not avoided, will result in death or serious injury.
 WARNING	Indicates a hazardous situation which, if not avoided, could result in death or serious injury.
 CAUTION	Indicates a hazardous situation which, if not avoided, could result in minor or moderate injury.
NOTICE	This is not a safety symbol. Indicates situations which, if not avoided, could result in property damage.
INFO	This is not a safety symbol. This symbol indicates important notes.
	Warning of a danger (general). The type of danger is specified by the warning text next to it.
	Warning of danger from electricity and its effects.
	Warning of danger from automatic start.

1.6 Abbreviations used

Abbr.	Meaning	Abbr.	Meaning
AT	Amplifier telegram.	IDNP	Product specific IDN
C1D	Class 1 diagnostic (fault)	IP	Peak current
C2D	Class 2 diagnostic (warning)	LSB	Least significant bit
C3D	Class 3 diagnostic (status)	MDT	Master data telegram
CCT	Communication cycle time (IDN2)	MSB	Most significant bit
CCW	Counter clockwise. Viewed to the shaft	MST	Master synchronization telegram
CUCT	Control unit cycle time (IDN1)	PFB	Position feedback
CUSB	Control unit synchronization bit (MDT control word bit 10)	ROD	Refer to AqB
CW	Clockwise. Viewed to the shaft	RTC	Real time control bit
CPx	Communication phase	RTS	Real time status bit
FOC	Fiber Optic Cable	S400	SERVOSTAR 400
F-SMA	FOC connector according to IEC 60874-2	S600	SERVOSTAR 600
IC	Continuous current	μI	Micro-Interpolator
IDN	Identification number		

2 Installation / Setup

2.1 Assembly / Installation



! WARNING

High Voltages up to 900V!

Risk of electric shock. Residual charges in the capacitors can still have dangerous levels several minutes after switching off the supply voltage. Power and control connections can still be live, even though the motor is not rotating.

- Install and wire up the equipment only while it is not electrically connected.
Make sure that the control cabinet is safely isolated (lock-out, warning signs etc.). The individual supply voltages will not be switched on until setup is carried out.
- Measure the voltage in the intermediate (DC-link) circuit and wait until it has fallen below 50V.



! CAUTION

Automatic Start!

Risk of death or serious injury for humans working in the machine. Drives with servo amplifiers in fieldbus systems are remote-controlled machines. They can start to move at any time without previous warning.

- Implement appropriate protective measures to ensure that any unintended start-up of the machines cannot result in dangerous situations for personnel or machinery.
- The user is responsible for ensuring that, in the event of a failure of the servo amplifier, the drive is set to a state that is functional safe, for instance with the aid of a safe mechanical brake.

Software limit-switches are not a substitute for the hardware limit-switches in the machine.

NOTICE

Install the servo amplifier as described in the instructions manual. The wiring for the analog setpoint input and the positioning interface is not required.

INFO

Because of the internal representation of the position-control parameters, the position controller can only be operated if the final limit speed of the drive at sinusoidal² commutation is not more than 7500 rpm. At trapezoidal commutation, the permitted maximum speed is 12000 rpm.

INFO

All the data on resolution, step size, positioning accuracy etc. refer to calculatory values. Non-linearities in the mechanism (backlash, flexing, etc.) are not taken into account. If the final limit speed of the motor has to be altered, then all the parameters that were previously entered for position control and motion blocks must be adapted.

2.1.1 Installing the expansion card (S600 only)

INFO

To fit the SERCOS expansion card, proceed as follows:

- Remove the cover of the option slot (see instructions manual of the servo amplifier.)
- Take care that no small items (such as screws) fall into the open option slot.
- Push the expansion card carefully into the guide rails that are provided, without twisting it.
- Press the expansion card firmly into the slot, until the front cover touches the fixing lugs. This ensures that the connectors make good contact.
- Screw the screws on the front cover into the threads in the fixing lugs.

2.1.2 Front view



2.1.3 LEDs

RT	Indicates whether SERCOS telegrams are being correctly received. In the final Communication Phase 4 this LED should flicker, since cyclical telegrams are being received.
TT	Indicates that SERCOS telegrams are being transmitted. In the final Communication Phase 4 this LED should flicker, since cyclical telegrams are being transmitted. Check the stations addresses for the controls and the servo amplifier if: <ul style="list-style-type: none"> - the LED never lights up in SERCOS Phase 1 or - the axis cannot be operated, although the RT LED is lighting up cyclically.
Err	Indicates that SERCOS communication is faulty or suffering from interference. If this LED is very bright, then communication is suffering strong interference, or is non-existent. Check the SERCOS transmission speed for the controls and the servo amplifier (BAUDRATE) and the fibre-optic connection. If this LED flickers, this indicates a low level of interference for SERCOS communication, or the optical transmitting power is not correctly adjusted to suit the length of cable. Check the transmitting power of the (physically) previous SERCOS station. The transmitting power of the servo amplifier can be adjusted in the setup software on the SERCOS screen page, by altering the parameter for the cable length.

2.1.4 Connection technology

For the fiber optic cable (FOC) connection, only use SERCOS components to the SERCOS Standard IEC 61491.

Receive data: The fiber optic cable carrying receive data for the amplifier in the ring structure is connected to **X13** with a F-SMA connector.

Transmit data: Connect the fiber optic cable for the data output to **X14** with a F-SMA connector.

Tightening torque for connectors max. 0,8 Nm.

2.1.5 Connection diagram

Layout of the SERCOS bus system in ring topology, with optical fibre cables (schematic with S600).

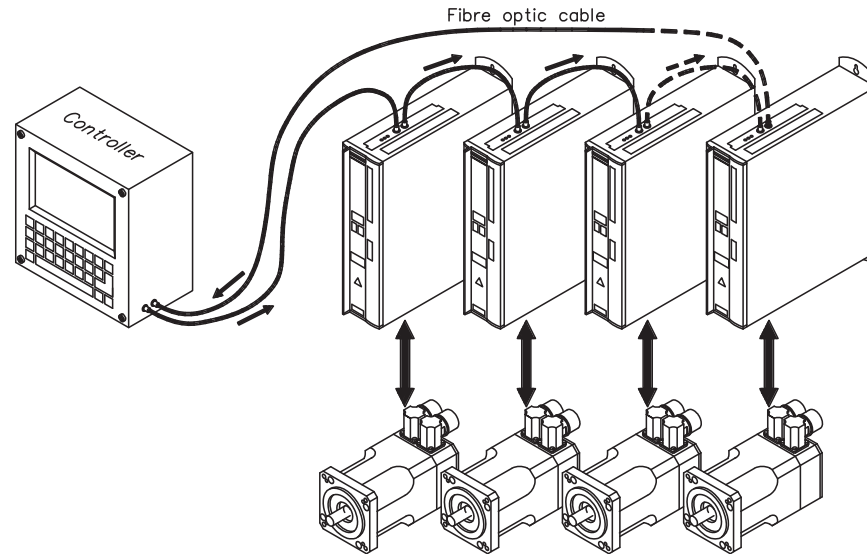

2.1.6 Modifying the station address

The amplifier address can be set to a value between 0 and 63. With address 0, the amplifier is assigned only as a repeater in the SERCOS ring.

There are various ways to set the station address:

Setup software

The SERCOS address can be modified in the setup software. For additional information, please refer to the online help in the Setup Software.

Alternatively, enter the command **ADDR #** in the "Terminal" screen, where # is the new address of the amplifier. An amplifier SAVE and COLDSTART is required for the new address to take affect.

Keys on the front of the servo amplifier

The SERCOS address can also be modified using the keys on the front of the SERVOSTAR. (For additional information, please refer to the instructions manuals).

2.1.7 Modifying the baud rate and optical power

If the baud rate is not set correctly, communication is not possible. The **SBAUD #** parameter can be used to set the baud rate, where # is the baud rate.

SBAUD	
2	2 MBAUD
4	4 MBAUD
8	8 MBAUD
16	16 MBAUD

If the optical power is not set correctly, errors occur in telegram transmission and the red LED on the amplifier lights up. During normal communication, the green send and receive LEDs flash, giving the impression that the relevant LED is on. The **SLEN #** parameter can be used to specify the optical range for a standard 1 mm² glass fibre cable, where # is the length of the cable in meters.

SLEN	
0	Very short connection
1... < 15	Length of the connection with a 1 mm ² plastic cable
15... < 30	Length of the connection with a 1 mm ² plastic cable
≥ 30	Length of the connection with a 1 mm ² plastic cable

Setup software

The parameters can be modified in the setup software, "SERCOS" screen (⇒ p.15 respectively p.15). Alternatively, the commands **SBAUD #** and **SLEN #** can be entered in the "Terminal" screen.

2.2 Setup

2.2.1 Guide to setup

NOTICE

Only professional personnel with extensive knowledge of control and amplifier technology are allowed to setup the servo amplifier.

Before setting up, the manufacturer of the machine must generate a risk assessment for the machine, and take appropriate measures to ensure that unforeseen movements cannot cause injury or damage to any person or property.

**Check assembly /
installation**

Check that all the safety instructions in the instructions manual for the servo amplifier and this manual have been observed and implemented. Check the setting for the station address and baud rate.

**Connect PC,
start setup software**

Use the setup software to set the parameters for the servo amplifier.

Setup basic functions

Start up the basic functions of the servo amplifier and optimize the current, speed and position controllers. This section of the setup is described in the in the online help of the setup software.

Save parameters

When the parameters have been optimized, save them in the servo amplifier.

Start up communication

Using the SERCOS screen in the setup software, configure the address, baud rate and optical power on the servo amplifier to operate properly with the SERCOS master.

These values can also be adjusted via a terminal emulator program such as the terminal in the servo amplifier's setup software or the Microsoft Windows® HYPERTERMINAL (see p.13).

When set successfully, save the parameters in the servo amplifier. The altered parameters will only become effective after a software-reset. To do this, click the Reset button in the tool bar of the setup software or from a terminal type "SAVE" followed by "COLDSTART".

CAUTION: Automatic Start

Risk of death or serious injury for humans working in the machine. The drive performing unplanned movements during commissioning cannot be ruled out. Make sure that, even if the drive starts to move unintentionally, no danger can result for personnel or machinery. The measures you must take in this regard for your task are based on the risk assessment of the application.

2.2.2 Setup Software

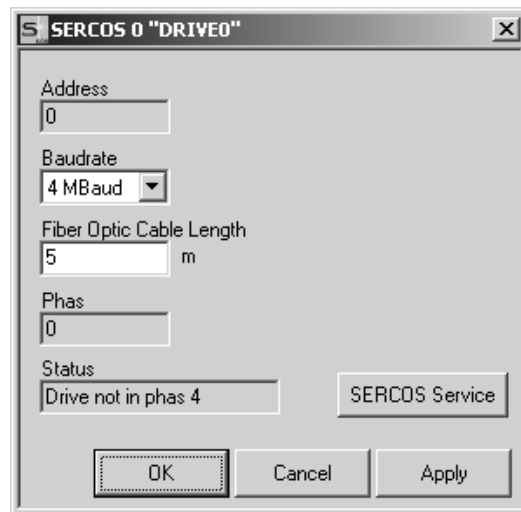

2.2.2.1 Screen page "SERCOS"

Address

The address mark the SERCOS station address of the amplifier, within the SERCOS communication. The address can be changed between 0 and 63 in the screen "Basic settings" (see p.13). Address 0 designates the amplifier as a repeater on the SERCOS ring.

Baud Rate

In this field it is possible to set the SERCOS baud rate.

Fiber Optic Cable Length

Within this parameter it is possible to change the optical power of the transmit output of the amplifier, to the next station in the ring. The optical power can be set for the length of fiber optic cable, in meters, from 1 to 45 meters.

If the optical power is not adjusted properly, there will be errors in the telegram transmission, and the red error LED on the amplifier will light. In normal communication, the green transmit and receive LEDs will light (referring to the LED of the optical transmission).

Phase

This field displays the actual phase of the SERCOS communication.

Status

This field displays the actual status of the SERCOS communication, according to the SERCOS status-word in text format.

2.2.2.2

Screen page "SERCOS SERVICE"

Read IDN

With this function it is possible to read special SERCOS IDN's which are not represented by an ASCII parameter. The number of the IDN should be entered into this field and the data can be demanded by the "Transmit Data" button.

Read List Item

This parameter could be used to read also IDN lists with the function "Read IDN". To use this, the requested list element must be chosen within this field, before using the "Read IDN" function.

EL 7 Dec/Hex

This fields contain the result of a "Read IDN" function in decimal and hexadecimal format.

EL 7 Read Error

This parameter will be set to 1 if the IDN number is not supported by the "Read IDN" list function

Product Sercos settings**EOT consequence (IDN P3015)**

This parameter defines the consequence of the Hardware Limit Switch, if the corresponding digital inputs are set to the limit switches. If the hardware limit switch consequence is set to 0, then the Limit switch consequence is a warning. Else if the IDN P3015 is set to 1, then the switch consequence is a fault.

Clear fault allow coldstart (IDN P3016)

This parameter defines the consequence of the reset command (IDN 99; ASCII CLRFAULT), for faults which require a coldstart. If this IDN is set, faults which require a coldstart will not clear.

Standard Sercos settings**Position polarity (IDN 55)**

The position polarity parameter is used to switch the polarities of position data. The motor shaft turns clockwise when there is a positive position setpoint difference and no inversion.

Position value 1 polarity (IDN 55)

This function can be used to invert the polarity of the internal actual-position value.

Position value 2 polarity (IDN 55)

This function can be used to invert the polarity of the external actual-position value.

Velocity polarity (IDN 43)

The velocity polarity parameter is used to switch the polarities of velocity data. The motor shaft turns clockwise when there is a positive velocity setpoint and no inversion.

Actual-speed polarity (IDN 43)

This function can be used to invert the polarity of the actual-speed value.

3 SERCOS IDN Set

INFO

The data used on the amplifier may differ from the data used for the SERCOS bus. For example, a speed setpoint can be specified for the amplifier in revolutions per minute, however increments per 250 μ s can be used for SERCOS.

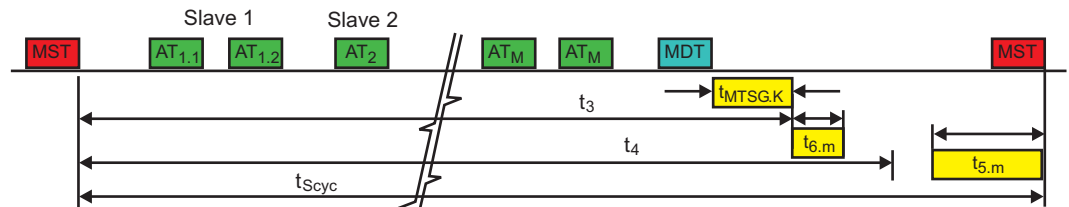

3.1 MDT Control Word, Bits 13 - 15

The following table gives a detailed description of the operation of the amplifier with regard to bits 13, 14 and 15 of the MDT Control Word sent by the master controller. Every amplifier receives its own control word. Please note that the three bits are ordered in the table according to priority.

Enable Amplifier 14	Amplifier On/Off 15	Halt/Restart 13	Description
0	x	x	When the "Enable Amplifier" bit changes from 1 to 0, the power stage is disabled and the motor coasts to a stop.
1	0	x	When the "Amplifier On/Off" bit changes from 1 to 0, the amplifier decelerates at the quick deceleration rate (IDNP3022). The power stage is disabled when the internal velocity setpoint is zero and the velocity feedback is below 5 RPM.
1	1	0	When the bits "Enable Amplifier" and "Amplifier On/Off" are set, the power stage is enabled. When the "Halt/Restart" bit changes from 1 to 0, the amplifier decelerates at the acceleration limit value defined by IDN137 or IDN42.
1	1	1	When the "Halt/Restart" bit changes from 0 to 1, the amplifier follows the master's setpoint values. In velocity and position mode, accelerations are limited by IDN136 or IDN137, and the velocity setpoint is limited by IDN38, IDN39 or IDN91. In position mode, the amplifier monitors the position setpoint and sets a fault if successive position setpoints exceed the velocity limit (IDN38, IDN39 or IDN91).

3.2 IDN Format

The IDN set supported by the servo amplifier is listed in numerical order with a short description for each IDN.

The descriptions use the following format.

IDNx Name

Description:

Data Length:		Non-Volatile:	
Data Type:		Write Access:	
Minimum:		Run-Up Check:	
Maximum:		Cyclic Transfer:	
Default:		ASCII Param:	
Units:		Version:	

Not all IDN descriptions require all of the fields listed above. Only the applicable fields are filled within an IDN description. The field definitions are as follows:

IDNx:

The identification number. An IDN combined with 'P' (IDNP) is a product specific IDN (manufacturer IDN) in a short hand notation. The actual IDN may be obtained by adding 32768 to the shorthand numeric value. For convenience, the actual IDN is given in parentheses following the shorthand notation.

Example:

IDNP = 3005 is a manufacturer-specific IDN

IDN = 3005 + 32768 = 35773.

Name:

A descriptive title of the IDN.

Description:

A short description of the purpose of the IDN.

Data Length:

The length of an IDN (defined by element 7 of each IDN), in bytes.

Possible entries for this field:

2 bytes - Length of the operating data is 2 bytes.

4 bytes - Length of the operating data is 4 bytes.

1 byte var. - Length of the operating data is variable. Length of one data element is 1 byte.

2 bytes var. - Length of the operating data is variable. Length of one data element is 2 bytes.

4 bytes var. - Length of the operating data is variable. Length of one data element is 4 bytes.

Data Format:

The format for interpreting and displaying the operating data. Possible entries for this field are binary, unsigned decimal, signed decimal, hexadecimal, text and IDN.

Minimum / Maximum:

The allowable range of IDN element 7 data. IDN element 7 is checked for range compliance in the service channel. In general, if the range is blank in the IDN description, this means that IDN elements 5 and 6 are not supported. The ranges of some IDNs are dependent upon the value of other IDNs, amplifier parameters or motor parameters.

Default:

The default value for IDN element 7 data. An IDN will revert to its default value after a firmware upgrade. The default may be a fixed value, or it may be stored in non-volatile memory. A blank "Default" field indicates that the IDN does not have a default value.

Units:

The units of IDN element 7 data and of the minimum, maximum, and default fields. The units of some IDNs are obtained from the operating data of other IDNs. IDNs of data type "binary", "text", or "IDN" do not have units and the "Units" field is left blank in the IDN description.

Non-Volatile:

Indicates whether the IDN operation data can be saved in non-volatile memory. Possible entries for this field are as follows:

- No - operating data is stored in volatile memory and is lost when logic power is removed.
- Yes - operating data may be stored in non-volatile memory and will be retained after power down.
- Fix - value can't be changed

Write Access:

The communication phases (CPx) during which an IDN may be written. In general an IDN may be read through the service channel during communication phases CP2 and above. However writing to an IDN may be restricted during some communication phases or while the amplifier is enabled. An entry of "Read-only" indicates that the IDN cannot be written during any communication phase.

Run-Up Check:

The communication phases (CPx) during which the validity of the operating data is checked. Possible entries for this field are as follows:

- (blank) - The validity of the operating data is not checked.
- CP2 - The validity of the operating data will be checked in the procedure "... Communication phase 3 transition check."
- CP3 - The validity of the operating data will be checked in the procedure "... Communication phase 4 transition check."

Cyclic Transfer:

Indicates whether cyclic transfer is possible for IDN element 7. Possible entries for this field are as follows:

- (blank) - The operating data is not cyclic.
- MDT - The IDN may be transferred within the MDT as cyclic data.
- AT - The IDN may be transferred within the AT as cyclic data.
- RTS - The IDN may be transferred within the AT as a realtime status bit.
- RTC - The IDN may be transferred within the MDT as a realtime control bit.

ASCII Parameter (abbreviation "ASCII Param.):

An equation of equivalent protocol commands that may be issued through the RS-232/485 serial port to obtain the IDN data. The contents of the IDN can be obtained by evaluating the equation. If no equivalent ASCII parameters are available, then the field is blank in the IDN description.

Version:

The version in which the IDN was implemented.

3.3 IDN1 Control Unit Cycle Time (t_{ncyc})

The control unit cycle time specifies the intervals at which new setpoints can be sent by the control unit. This parameter is transmitted in communication phase 2 and activated in communication phase 3.

However, the following condition applies for the control unit cycle time: IDN1 = IDN2

3.4 IDN2 Communication Cycle Time (t_{scyc})

The communication cycle time specifies the intervals at which cyclic data is transmitted.

Valid times: 500, 1000, 2000, ... 8000 μ s. A cycle time of 1 ms or less can only be used with a limited range of functions.

Up to a maximum cycle time of 4 ms, the setpoints are interpolated linearly to 250 μ s. Interpolation is not performed for higher cycle times, resulting in poor regulation properties.

In addition, spline interpolation is available at a cycle time of 500 μ s (see also IDN 3040).

In CP1+2, a 2 ms cycle time is always used (according to the Sercos standard) and the desired cycle time can only be enabled in CP3 and onwards.

Data Length:	2 bytes	Non-Volatile:	No
Data Type:	Unsigned decimal	Write Access:	CP2
Minimum:	1000	Run-Up Check:	CP2
Maximum:	8000	Cyclic Transfer:	
Default:	2000	ASCII Param:	
Units:	μ s	Version:	

3.5 IDN3 Shortest AT Transmission Starting Time (t_{1min})

The time required by the amplifier between end of MST and beginning of the amplifier's AT.

Data Length:	2 bytes	Non-Volatile:	Yes
Data Type:	Unsigned decimal	Write Access:	Read-only
Minimum:		Run-Up Check:	
Maximum:		Cyclic Transfer:	
Default:	2...4MBaud: 12 8...16MBaud: 4	ASCII Param.:	
Units:	μ s	Version:	

3.6 IDN4 Transmit/Receive Transition Time (t_{ATMT})

The time required by the amplifier between the end of the AT and the beginning of the next MDT.

Data Length:	2 bytes	Non-Volatile:	Yes
Data Type:	Unsigned decimal	Write Access:	Read-only
Minimum:		Run-Up Check:	
Maximum:		Cyclic Transfer:	
Default:	12	ASCII Param.:	
Units:	μ s	Version:	

3.7 IDN5 Minimum Feedback Processing Time (t_5)

The time required by the amplifier for receiving and processing cyclic feedback. This time period is measured from the beginning of the feedback acquisition to the end of the next MST.

Data Length:	2 bytes	Non-Volatile:	Yes
Data Type:	Unsigned decimal	Write Access:	Read-only
Minimum:		Run-Up Check:	
Maximum:		Cyclic Transfer:	
Default:	200	ASCII Param.:	
Units:	μ s	Version:	

3.8 IDN6 AT Transmission Starting Time (t_1)

The time at which the amplifier should transmit its Amplifier Telegram (AT) during CP3 and CP4, measured from the end of the MST, otherwise changeover to CP3 is blocked.

$$\begin{array}{ccccccc} \text{IDN3} & < & \text{IDN6} & < & \text{IDN89} & - & \text{IDN4} \\ \text{Min.AT.Transm.Start.time} & < & \text{AT Transm.Start.time} & < & \text{MDT Trans.Start.time} & - & \text{Transm/Rec.trans.time} \\ t_{1\text{min}} & < & T_1 & < & T_2 & - & t_{\text{ATMT}} \end{array}$$

Data Length:	2 bytes	Non-Volatile:	No
Data Type:	Unsigned decimal	Write Access:	CP2
Minimum:		Run-Up Check:	CP2
Maximum:		Cyclic Transfer:	
Default:	None	ASCII Param.:	
Units:	μ s	Version:	

3.9 IDN7 Feedback Acquisition Capture Point (t_4)

The time at which the amplifier should latch the feedback values after the end of the MST. The "Feedback Acquisition Capture Point" is limited by the CCT (IDN2) and the "Minimum Feedback Processing Time" (IDN5) according to the following equation.

$$\text{IDN7} \leq \text{IDN2} - \text{IDN5}$$

Data Length:	2 bytes	Non-Volatile:	No
Data Type:	Unsigned decimal	Write Access:	CP2
Minimum:		Run-Up Check:	CP2
Maximum:		Cyclic Transfer:	
Default:	IDN2 - IDN5	ASCII Param.:	
Units:	μ s	Version:	

3.10 IDN8 Command Value Valid Time (t_3)

The time at which the amplifier is allowed to access the new command values after the MST. The "Command Value Valid Time" is limited by the "MDT Transmission Starting Time" (IDN89), the "Command Value Processing Time" (IDN90) and the CCT (IDN2) according to this equation.

$$\text{IDN89} + \text{MDT Transmission Time} + \text{IDN90} < \text{IDN8} \leq \text{IDN2}$$

Data Length:	2 bytes	Non-Volatile:	No
Data Type:	Unsigned decimal	Write Access:	CP2
Minimum:		Run-Up Check:	CP2
Maximum:		Cyclic Transfer:	
Default:	IDN2	ASCII Param.:	
Units:	μ s	Version:	

3.11 IDN9 Position of Data Record in MDT

The offset of the amplifier's data record within the MDT. The offset is measured in bytes from the MDT's address field. The data record position within the MDT must be downloaded from the master during CP2 and becomes active during CP3. The value must be greater than zero and must be an odd number not exceeding 65531.

Data Length:	2 bytes	Non-Volatile:	No
Data Type:	Unsigned decimal	Write Access:	CP2
Minimum:		Run-Up Check:	CP2
Maximum:		Cyclic Transfer:	
Default:	None	ASCII Param.:	
Units:	Bytes	Version:	

3.12 IDN10 Length of MDT

The length of the MDT's data field, expressed in bytes. This length does not include the MDT delimiters, address field, or cyclic redundancy check (CRC). The MDT length must be downloaded from the master during CP2 and becomes active during CP3. The MDT length must be an even number, and it must be greater than or equal to 4, but not exceeding 65534.

Data Length:	2 bytes	Non-Volatile:	No
Data Type:	Unsigned decimal	Write Access:	CP2
Minimum:		Run-Up Check:	CP2
Maximum:		Cyclic Transfer:	
Default:	4	ASCII Param.:	
Units:	Bytes	Version:	

3.13 IDN11 Class 1 Diagnostic (C1D)

The present fault status of the amplifier. When a fault occurs, the amplifier decelerates to a stop and is disabled. The C1D status bit (AT bit 13) is set, and the corresponding fault bits are set within IDN11. All faults are latched within IDN11 and are reset through the "Procedure: Reset Class 1 Diagnostic" (IDN99). IDN99 performs a coldstart automatically when required. A coldstart automatically results in the loss of communication. Those faults which require a coldstart are noted in the table below. The error messages which are displayed with LEDs on the front panel of the servo amplifier are also shown below.

Bit	Description	Coldstart	Error
LSB 0	Overload fault (IDN114).	no	F15
1	Amplifier over temperature fault (IDN203).	no	F01
2	Motor over temperature fault.	yes	F06
3	Cooling system fault (IDN205).	no	F13
4	Control voltage fault ($\pm 15V$).	yes	F07
5	Feedback loss fault.	yes	F04
6	Commutation fault. Set to 0.	yes	F25
7	Overcurrent fault.	yes	F14
8	Overvoltage fault.	no	F02
9	Undervoltage fault.	no	F05
10	Power supply phase fault.	yes	F12, F19
11	Excessive position deviation (IDN159).	no	F03
12	Communication interface fault (IDN14).	no	F29
13	Software limit switch fault (IDN49 and 50).	no	F24
14	Reserved. Set to 0.		
MSB 15	Manufacturer-defined fault (IDN129).	IDN129	

Data Length:	2 bytes	Non-Volatile:	No
Data Type:	Binary	Write Access:	Read-only
Minimum:		Run-Up Check:	
Maximum:		Cyclic Transfer:	AT
Default:	0	ASCII Param.:	ERRCODE

3.14 IDN12 Class 2 Diagnostic (C2D)

Warning flags that may indicate an impending shutdown. When an unmasked warning condition changes state, the corresponding warning bits are changed within IDN12, and the C2D change bit (AT status word, bit 12) is set. The warning bits within IDN12 are not latched and will automatically reset when the warning condition is no longer valid. The C2D change bit is reset when IDN12 is read through the service channel. IDN97 may be used to mask warnings and their affect on the C2D change bit.

Bit	Description
LSB 0	Overload warning (IDN114)
1	
2	Motor over temperature warning (IDN312)
3...12	
13	Target position outside of travel range (IDN323).
14	
MSB 15	Manufacturer-defined warning flags (IDN181).

Data Length:	2 bytes	Non-Volatile:	No
Data Type:	Binary	Write Access:	Read-only
Minimum:		Run-Up Check:	
Maximum:		Cyclic Transfer:	
Default:		ASCII Param.:	

3.15 IDN13 Class 3 Diagnostic (C3D)

Status flags for the amplifier. When an unmasked status condition changes state, the corresponding status bit changes within IDN13, and the C3D change bit (AT status word, bit 11) is set. The status bits within IDN13 are not latched and will automatically reset when the status condition is no longer valid. The C3D change bit is reset when IDN13 is read through the service channel. IDN98 may be used to mask particular status conditions and their affect on the C3D change bit.

Bit	Description
LSB 0	
1...3	
4	
5	
6	In Position (IDN57 and IDN336)
7...14	
MSB 15	Manufacturer-defined status flags (IDN182).

Data Length:	2 bytes	Non-Volatile:	No
Data Type:	Binary	Write Access:	Read-only
Minimum:		Run-Up Check:	
Maximum:		Cyclic Transfer:	
Default:		ASCII Param.:	

3.16 IDN14 Interface Status

The communication phase (CPx) and communication fault flags. In the event of a communication fault the amplifier stops and is disabled, and the amplifier's communication phase returns to 0. The communication interface fault summary bit (IDN11, bit 12) is set. The cause of the communication fault is latched within IDN14 along with the communication phase in which the fault occurred. The master may retrieve this information from the amplifier by reading IDN14 before issuing a "Reset Class 1 Diagnostic" procedure (IDN99).

If both bit 3 and bit 4 (MST and MDT failures) are set, this could indicate a signal loss (e.g. a broken optical fiber cable). In this case, the MST and MDT error counters (IDN28 and IDN29) will not be incremented.

Bit	Description
2 - 0	Communication Phase (CPx).
3	MST failure.
4	MDT failure.
5	Invalid phase (CP > 4)
6	Error during phase advance.
7	Error during phase regression.
8	Phase switch without proper acknowledgment.
9	Switching to an uninitialized operation mode.
10 - 15	

Data Length:	2 bytes	Non-Volatile:	No
Data Type:	Binary	Write Access:	Read-only
Minimum:		Run-Up Check:	
Maximum:		Cyclic Transfer:	
Default:		ASCII Param.:	

3.17 IDN15 Telegram Type Parameter

The master uses IDN15 to select the contents of the AT and MDT cyclic data fields. Selecting a pre-defined or standard telegram type completely defines the contents and order of cyclic data within the AT and MDT. Within IDN15, the servo amplifier supports values 1 through 7. Telegram type 7, or the application type telegram, allows the master to define the contents and order of the AT and MDT cyclic data. The IDNs that may be transferred as cyclic data within the AT and MDT are listed in IDN187 and IDN188 respectively. The maximum amount of AT and MDT cyclic data that the amplifier can transfer is specified in IDN185 and IDN186 respectively. When the application telegram is selected, the master writes the desired cyclic data IDNs for the AT into IDN16 and for the MDT into IDN24.

IDN15 Value	Telegram Type	Telegram Cyclic Data	
		MDT (Commands)	AT (Feedback)
0			
1			
2	Standard telegram 2	Velocity (IDN36)	Velocity (IDN40)
3	Standard telegram 3	Velocity (IDN36)	Motor Position (IDN51)
11			External Position (IDN53)
4	Standard telegram 4	Position (IDN47)	Motor Position (IDN51)
12			External Position (IDN53)
5	Standard telegram 5	Pos/Vel (IDN47/36)	Motor Pos/Vel (IDN51/40)
13			External Pos/Vel (IDN53/40)
6			
7	Application telegram	Contents defined in IDN24	Contents defined in IDN16

Data Length:	2 bytes	Non-Volatile:	No
Data Type:	Binary	Write Access:	CP2
Minimum:		Run-Up Check:	CP2
Maximum:		Cyclic Transfer:	
Default:	4	ASCII Param.:	FB_VNI

3.18 IDN16 Configuration List of AT Cyclic Data

An IDN list of the AT's cyclic data. The master fills this list with IDNs in CP2 selected from a list of configurable AT data (IDN187) when an application telegram has been selected through IDN15.

Data Length:	2 bytes elements, variable length array	Non-Volatile:	No
Data Type:	IDN	Write Access:	CP2
Minimum:		Run-Up Check:	CP2
Maximum:		Cyclic Transfer:	
Default:	Empty list	ASCII Param.:	

3.19 IDN17 IDN List of All Operation Data

An IDN list of all data IDNs that are supported by the amplifier.

Data Length:	2 byte elements, variable length array	Non-Volatile:	Fix
Data Type:	IDN	Write Access:	Read-only
Minimum:		Run-Up Check:	
Maximum:		Cyclic Transfer:	
Default:		ASCII Param.:	

3.20 IDN18 IDN List of Operation Data for CP2.

A list of all IDNs that must be written by the master during CP2. That are IDN 6, 9,10,16, 24 and 89. The amplifier's CP2 to CP3 transition procedure (IDN127) will fail if this data is not supplied by the master. IDN16 and IDN24 are not included in this list, but they need to be written by the master in CP2 if the application telegram (type 7) is selected. If IDN16 and IDN24 are not written during CP2, then the application telegram will be empty.

Data Length:	2 byte elements, variable length array	Non-Volatile:	Fix
Data Type:	IDN	Write Access:	Read-only
Minimum:		Run-Up Check:	
Maximum:		Cyclic Transfer:	
Default:	6	ASCII Param.:	

3.21 IDN19 IDN List of Operation Data for CP3

A list of all IDNs that must be written by the master during CP3. The amplifier's CP3 to CP4 transition procedure (IDN128) will fail if this data is not supplied by the master.

Data Length:	2 byte elements, variable length array	Non-Volatile:	Fix
Data Type:	IDN	Write Access:	Read-only
Minimum:		Run-Up Check:	
Maximum:		Cyclic Transfer:	
Default:		ASCII Param.:	

3.22 IDN21 IDN List of Invalid Operation Data for CP2

A list of all IDNs which are considered invalid by the CP2 to CP3 transition procedure (IDN127).

Data Length:	2 byte elements, variable length array	Non-Volatile:	No
Data Type:	IDN	Write Access:	Read-only
Minimum:		Run-Up Check:	
Maximum:		Cyclic Transfer:	
Default:	Empty list.	ASCII Param.:	

3.23 IDN22 IDN List of Invalid Operation Data for CP3

A list of all IDNs which are considered invalid by the CP3 to CP4 transition procedure (IDN128).

Data Length:	2 byte elements, variable length array	Non-Volatile:	No
Data Type:	IDN	Write Access:	Read-only
Minimum:		Run-Up Check:	
Maximum:		Cyclic Transfer:	
Default:	Empty list.	ASCII Param.:	

3.24 IDN24 Configuration List of MDT Cyclic Data

A list of IDNs in the MDT's cyclic data. The master fills this list with IDNs selected from a list of configurable MDT data (IDN188) when an application telegram has been selected through IDN15.

Data Length:	2 byte elements, variable length array	Non-Volatile:	No
Data Type:	IDN	Write Access:	CP2
Minimum:	0	Run-Up Check:	CP2
Maximum:	6	Cyclic Transfer:	
Default:	Empty list.	ASCII Param.:	

3.25 IDN25 IDN List of All Procedure Commands

An list of all command IDNs that are supported by the amplifier.

IDN	Description
99	Reset Class 1 Diagnostic, ASCII "CLRFAULT"
127	Check routine before switching from CP2 to CP3
128	Check routine before switching from CP3 to CP4
139	Command "Parking axis" enables CP4 despite any errors that are present. Enabling is not possible when this command is activated.
148	Homing command
170	Command probe
262	Command "Load default values"; ASCII "RSTVAR"
264	Command "Save parameters"; ASCII "SAVE"

Data Length:	2 byte elements, variable length array	Non-Volatile:	Yes
Data Type:	IDN	Write Access:	Read-only
Minimum:		Run-Up Check:	
Maximum:		Cyclic Transfer:	
Default:	Empty list	ASCII Param.:	

3.26 IDN28 MST Error Counter

A count of all invalid MSTs in CP3 and CP4. In the case where more than two consecutive MSTs are invalid, only two are counted, and the amplifier returns to CP0. The MST error counter counts to a maximum of 65535 and does not roll over to 0. If a value of 65535 is in the counter, there may have been a noisy transmission over a long period of time. The MST error counter is cleared on the transition from CP2 to CP3.

Data Length:	2 bytes	Non-Volatile:	No
Data Type:	Unsigned decimal	Write Access:	CP2, CP3, CP4
Minimum:		Run-Up Check:	
Maximum:		Cyclic Transfer:	
Default:		ASCII Param.:	

3.27 IDN29 MDT Error Counter

A count of all invalid MDTs in CP4. In the case where more than two consecutive MDTs are invalid, only two are counted, and the amplifier returns to CP0. The MDT error counter counts to a maximum of 65535 and does not roll over to 0. If a value of 65535 is in the counter, there may have been a noisy transmission over a long period of time. The MDT error counter is cleared on the transition from CP2 to CP3.

Data Length:	2 bytes	Non-Volatile:	No
Data Type:	Unsigned decimal	Write Access:	CP2, CP3, CP4
Minimum:		Run-Up Check:	
Maximum:		Cyclic Transfer:	
Default:		ASCII Param.:	

3.28 IDN30 Manufacturer Version

A string of the SERCOS firmware version that is installed in the servo amplifier.

Data Length:	1 byte elements, variable length array	Non-Volatile:	Fix
Data Type:	Text	Write Access:	Read-only
Minimum:		Run-Up Check:	
Maximum:		Cyclic Transfer:	
Default:		ASCII Param.:	VER *

3.29 IDN32 Primary Operation Mode

Defines the amplifier's operational mode when the AT status word bits 8 and 9 are both 0. The master requests a particular operation mode through the MDT control word (bits 8 and 9). The master can switch between the operation modes defined within this IDN and the mode defined within the secondary operation mode 1 (IDN33) with this bits in realtime. Switch into position control during fast moving, could result in a jerk. The following table may be used to define the primary operation mode. All reserved bits are not supported and must be zero. The gain for bit 3 is defined by IDN296, Velocity Feed Forward Gain. It is not possible to select position control with motor feedback in IDN32 and position control using external feedback in IDN33, also the reverse setting of this IDNs is not possible and will be checked by the amplifier (refer to IDN117). For position control with external feedback 2, all position data, e.g. also IDN51, are used for the external feedback. IDN 32, for example, is also saved in BUSP2 (see ASCII documentation).

Bit	Value	Description
3 - 0	0000	Reserved: no operation mode
	0001	Torque control
	0010	Velocity control
	x011	Position control using motor feedback.
	x100	Position control using external feedback.
3	x101	Reserved: position control with motor feedback and external feedback
	0	Position control with following error.
4 - 15	1	Position control without following error (IDN296).
	0	.

Data Length:	2 bytes	Non-Volatile:	yes
Data Type:	Binary	Write Access:	CP2, CP3
Minimum:		Run-Up Check:	CP3
Maximum:		Cyclic Transfer:	
Default:	3	ASCII Param.:	FB_VNI

3.30 IDN33 Secondary Operation Mode 1

Defines the amplifier's operational mode when the AT status word bit 9 is clear and bit 8 is set. The master requests a particular operation mode through the MDT control word (bits 8 and 9). The master can switch between the operation modes defined within this IDN and the mode defined within the primary operation mode (IDN32) with this bits in realtime. Switch into position control during fast moving, could result in a jerk. The following table may be used to define the secondary operation mode 1. All reserved bits are not supported and must be zero. The gain for bit 3 is defined by IDN296, Velocity Feed Forward Gain. It is not possible to select position control with motor feedback in IDN32 and position control using external feedback in IDN33, also the reverse setting of this IDNs is not possible and will be checked by the amplifier (refer to IDN117). For position control with external feedback 2, all position data, e.g. also IDN51, are used for the external feedback.

Bit	Value	Description
3 - 0	0000	No mode of operation.
	0001	Torque control
	0010	Velocity control
	x011	Position control using motor feedback.
	x100	Position control using external feedback.
3	x101	Reserved: Position control using motor and external feedback.
	0	Position control with following error.
4 - 15	1	Position control without following error (IDN296).
	0	not used

Data Length:	2 bytes	Non-Volatile:	No
Data Type:	Binary	Write Access:	CP2, CP3
Minimum:		Run-Up Check:	CP3
Maximum:		Cyclic Transfer:	
Default:	0	ASCII Param.:	

3.31 IDN36 Velocity Setpoint Value

The master issues the velocity setpoint to the amplifier through IDN36. The velocity scaling type is defined with IDN44, and the scaling parameters are adjustable (IDN45 and 46). The data mapped to cyclic data cannot be influenced via the service channel.

Data Length:	4 bytes	Non-Volatile:	No
Data Type:	Signed decimal	Write Access:	CP4
Minimum:		Run-Up Check:	
Maximum:		Cyclic Transfer:	MDT
Default:		ASCII Param.:	J
Units:	IDN44, 45, 46 (Default: RPM / 10000*)	Version:	

*: 10000~60rpm

3.32 IDN38 Positive Velocity Limit Value

Establishes the maximum acceptable velocity setpoint in the positive direction. In velocity mode and during homing, velocity setpoints that exceed the positive velocity limit are clamped to the positive velocity limit. In position mode, the velocity is monitored, and if the positive velocity exceeds the positive velocity limit, a fault is generated (IDN129, bit 10).

Data Length:	4 bytes	Non-Volatile:	Yes
Data Type:	Signed Decimal	Write Access:	CP2, CP3, CP4
Minimum:	0	Run-Up Check:	
Maximum:	IDN113, IDN91	Cyclic Transfer:	
Default:	3000 RPM	ASCII Param.:	VLIMP
Units:	IDN44, 45, 46 (Default: RPM / 10000*)	Version:	

*: 10000~60rpm

3.33 IDN39 Negative Velocity Limit Value

Establishes the maximum acceptable velocity setpoint in the negative direction. In velocity mode and during homing, velocity setpoints that exceed the negative velocity limit are clamped to the negative velocity limit. In position mode, the velocity is monitored, and if the negative velocity exceeds the negative velocity limit, a fault is generated (IDN129, bit 9).

Data Length:	4 bytes	Non-Volatile:	Yes
Data Type:	Signed Decimal	Write Access:	CP2, CP3, CP4
Minimum:	- IDN113, -IDN91	Run-Up Check:	
Maximum:	0	Cyclic Transfer:	
Default:	- 3000 RPM	ASCII Param.:	VLIMN
Units:	IDN44, 45, 46 (Default: RPM / 10000*)	Version:	

*: 10000~60rpm

3.34 IDN40 Velocity Feedback Value

The master retrieves the velocity feedback from the amplifier through IDN40. The velocity scaling type is defined with IDN44, and the scaling parameters are adjustable (IDN45 and 46).

Data Length:	4 bytes	Non-Volatile:	No
Data Type:	Signed decimal	Write Access:	Read-only
Minimum:		Run-Up Check:	
Maximum:		Cyclic Transfer:	AT
Default:		ASCII Param.:	V
Units:	IDN44, 45, 46 (Default: RPM * 10000)	Version:	

3.35 IDN41 Homing Velocity

The amplifier's velocity during the "Amplifier-Controlled Homing" procedure command (IDN148). The actual homing velocity may be limited by the Bipolar, Positive, or Negative Velocity Limit Values (IDN91, 38, 39 respectively). The velocity scaling type is defined with IDN44, and the scaling parameters are adjustable (IDN45 and 46). The unit differs because linear scaling (IDN 44 = 0x01) is also supported.

Data Length:	4 bytes	Non-Volatile:	Yes
Data Type:	Signed decimal	Write Access:	CP2, CP3, CP4
Minimum:	0	Run-Up Check:	
Maximum:	$2^{31} - 1$	Cyclic Transfer:	
Default:	23 RPM	ASCII Param.:	VREF
Units:	IDN44, 45, 46 (Default: RPM * 10000)	Version:	

3.36 IDN42 Homing Acceleration

The amplifier's maximum acceleration and deceleration during the "Amplifier-Controlled Homing" procedure (IDN148).

Data Length:	4 bytes	Non-Volatile:	Yes
Data Type:	Unsigned decimal	Write Access:	CP2, CP3, CP4
Minimum:	1	Run-Up Check:	
Maximum:	$2^{16} - 1$	Cyclic Transfer:	
Default:	10	ASCII Param.:	ACCR, DECR
Units:	IDN160, 161, 162	Version:	

3.37 IDN43 Velocity Polarity Parameter

The velocity polarity parameter is used to switch the polarities of velocity data. Polarities are not switched internally but externally, this means on the in- and output of a closed loop system. **(SERCOS bus data are inverted, the servo amplifier data are not changed, limit switch data are not changed).**

The motor shaft turns clockwise when there is a positive velocity setpoint and no inversion.

Bit		Description
0	Velocity setpoint value	0 = non-inverted 1 = inverted
1		
2	Velocity feedback value	0 = non-inverted 1 = inverted
15-3		

Data Length:	2 bytes	Non-Volatile:	Yes
Data Type:	Binary	Write Access:	CP2
Minimum:	0	Run-Up Check:	
Maximum:	0005h	Cyclic Transfer:	
Default:	0	ASCII Param.:	SERCSET (bits 12-15)

3.38 IDN44 Velocity Data Scaling Type

Defines the scaling options for all velocity data.

The scaling types which are supported are:

0x1h, 0x2h, 0xAh, 0x41h, 0x42h, 0x4Ah

If preferred rotational scaling is selected, the velocity scaling factor (IDN45) will set to 1 and the velocity data scaling exponent (IDN46) will set to -4 (refer to IDN45 and 46).

Bit		Description
2 - 0	Scaling Method	001 = Linear Scaling 010 = Rotational Scaling
3	Standard Scaling Type	0 = Preferred Scaling 1 = Parameter Scaling
4	Units for Linear Scaling	0 = Meters (m)
4	Units for Rotational Scaling	0 = Revolutions @
5	Time Units	0 = Minutes (min)
6	Data Reference	0 = At the Motor Shaft 1 = At the Load
15-7	Reserved	

Data Length:	2 bytes	Non-Volatile:	No
Data Type:	Binary	Write Access:	CP2, CP3
Minimum:	0x0002h	Run-Up Check:	
Maximum:	0x0004Ah	Cyclic Transfer:	
Default:	0x000Ah	ASCII Param.:	

3.39 IDN45 Velocity Data Scaling Factor

The scaling factor for all velocity data in the amplifier. The exponent is defined with IDN46, so that the LSB weight of all rotational velocity data is derived from the following equation:

$$LSBWeight = factor(IDN45) \cdot 10^{exponent(IDN46)} \left\{ \begin{array}{l} unit(revolutions) \\ time\ unit(minutes) \end{array} \right\}$$

The scaling may be defined within the following range: 1×10^{-5} to 1×100 . IDN45 and IDN46 must be integers. If the preferred rotational scaling is selected in IDN44, the velocity scaling factor (IDN45) and the velocity data scaling exponent (IDN46) will be fixed at their default values (refer to IDN44). With velocity scaling it is possible to get a rounding error in the LSBits.

Data Length:	2 bytes	Non-Volatile:	No
Data Type:	Unsigned decimal	Write Access:	CP2, CP3
Minimum:	1	Run-Up Check:	
Maximum:	$10^{(IDN46)}$	Cyclic Transfer:	
Default:	1	ASCII Param.:	

3.40 IDN46 Velocity Data Scaling Exponent

The scaling exponent for all velocity data in the amplifier. Refer to IDN45.

IDN46 = -6 reduces the max. permitted speed to approx. +/-2300rpm (counter overflow).

Data Length:	2 bytes	Non-Volatile:	No
Data Type:	Signed decimal	Write Access:	CP2, CP3
Minimum:	-5	Run-Up Check:	
Maximum:	- log (IDN45)	Cyclic Transfer:	
Default:	-4	ASCII Param.:	

3.41 IDN47 Position Setpoint Value

The master issues position setpoints to the amplifier as cyclic data through IDN47. Position setpoints written via the service channel do not have any affect. The "Position Setpoint Value" has a defined scaling type (IDN76) and a defined resolution (IDN76, 77, 78, 79, 123).

Data Length:	4 bytes	Non-Volatile:	No
Data Type:	Signed decimal	Write Access:	CP4
Minimum:		Run-Up Check:	
Maximum:		Cyclic Transfer:	MDT
Default:		ASCII Param.:	
Units:	IDN76, 77, 78, 79, 123	Version:	

3.42 IDN49 Positive Position Limit

This IDN defines the maximum permissible position in the positive direction. The position limit switch is active when IDN55 bit 4 or IDNP3004 is set. If linear scaling is selected in IDN76, the limit switch is automatically calculated with the feed constant IDN123 and enabled with the enable bit in IDN55. When the position command value reaches the limit switch, the drive decelerates to a stop and error "F24" and warning "n07" flash in the LED. In addition, fault bit 13 is set in IDN11 and the warning bit is set in IDN323 and IDN12 bit 13. With linear position scaling the maximum value is 1024 x feed constant (IDN123).

Data Length:	4 bytes	Non-Volatile:	YES
Data Type:	Signed decimal	Write Access:	CP2, CP3, CP4
Minimum:	$-2^{31}+1$	Run-Up Check:	
Maximum:	$2^{31}-1$	Cyclic Transfer:	
Default:	0	ASCII Param.:	SWE2
Units:	IDN76, 77, 78, 79, 123	Version:	

3.43 IDN50 Negative Position Limit

This IDN defines the maximum permissible position in the negative direction. See IDN 49.

Data Length:	4 bytes	Non-Volatile:	YES
Data Type:	Signed decimal	Write Access:	CP2, CP3, CP4
Minimum:	$-2^{31}+1$	Run-Up Check:	
Maximum:	$2^{31}-1$	Cyclic Transfer:	
Default:	0	ASCII Param.:	SWE1
Units:	IDN76, 77, 78, 79, 123	Version:	

3.44 IDN51 Position Feedback Value 1 (Motor Feedback)

The master retrieves the motor's position feedback from the amplifier through IDN51. The scaling type and the resolution will be defined within IDN76, 77, 78 and 79.

Data Length:	4 bytes	Non-Volatile:	No
Data Type:	Signed decimal	Write Access:	Read-only
Minimum:		Run-Up Check:	
Maximum:		Cyclic Transfer:	AT
Default:		ASCII Param.:	PFB
Units:	IDN76, 77, 78, 79, 123	Version:	

3.45 IDN52 Reference Distance 1 (Motor Feedback)

The distance from the machine zero point to the home position, referenced through the motor feedback.

Data Length:	4 bytes	Non-Volatile:	Yes
Data Type:	Signed decimal	Write Access:	CP2, CP3, CP4
Minimum:	$-2^{31} + 1$	Run-Up Check:	
Maximum:	$2^{31} - 1$	Cyclic Transfer:	
Default:	0	ASCII Param.:	ROFFS
Units:	IDN76, 77, 78, 79, 123	Version:	

3.46 IDN53 Position Feedback Value 2 (External Feedback)

The external position feedback of the amplifier from an external encoder, in rotational position resolution within IDN79. For linear position scaling this IDN is in counts, not in SERCOS units (refer to IDN76 and 79).

Data Length:	4 bytes	Non-Volatile:	No
Data Type:	Signed decimal	Write Access:	Read-only
Minimum:		Run-Up Check:	
Maximum:		Cyclic Transfer:	AT
Default:		ASCII Param.:	PFB0
Units:	IDN76, 79	Version:	

3.47 IDN54 Reference Distance 2 (External Feedback)

The distance from the machine zero point to the home position for the secondary feedback. If homing is done, the position feedback value 2 (IDN53) contains the value of this IDN (refer to IDN 148).

Data Length:	4 bytes	Non-Volatile:	Yes
Data Type:	Signed decimal	Write Access:	CP2, CP3, CP4
Minimum:	$-2^{31} + 1$	Run-Up Check:	
Maximum:	$2^{31} - 1$	Cyclic Transfer:	
Default:	0	ASCII Param.:	ROFFS0
Units:	IDN76, 79	Version:	

3.48 IDN55 Position Polarity Parameter

The position polarity parameter is used to switch the polarities of position data. Polarities are not switched internally but externally, this means on the input and output of a closed loop system. **(SERCOS bus data are inverted, servo amplifier data and limit switch data are not changed).** The motor shaft turns clockwise when there is a positive position setpoint difference and no inversion.

Bit		Description	
0	Position setpoint value*	0 = non-inverted	1 = inverted
1	Reserved: Additive position setpoint value	0 = non-inverted	1 = Reserved (inverted)
2	Position feedback value 1*	0 = non-inverted	1 = inverted
3	Position feedback value 2*	0 = non-inverted	1 = inverted
4	Position limit values (software limit switches)	0 = disabled	1 = enabled**
15-5			

* Homing direction DREF is **not** changed!

** If linear scaling of the position data is selected (see IDN76 – Position Data Scaling Type), these bits will be automatically set and it is not possible to disable the position limit switches (see IDN49 and 50 – Pos./Neg. Position Limit Switch).

If the position limit switches are set, the amplifier sets a software limit switch (Bit 13 in IDN11 - Class 1 –current fault status of the amplifier), if the drive reaches the disallowed area. A new value in bit 4 will not become active until this parameter is saved to the non-volatile memory and a coldstart or warmstart (IDN128) procedure is initiated.

Data Length:	2 bytes	Non-Volatile:	Yes
Data Type:	Binary	Write Access:	CP2
Minimum:	0	Run-Up Check:	
Maximum:	0x001D h	Cyclic Transfer:	
Default:	0	ASCII Param.:	SERCSET (Bits 4 - 11)

3.49 IDN57 Position Window

Defines the maximum absolute distance between the position setpoint value and the position feedback value. When the following error is within the "Position Window," the amplifier sets the status flag "In Position" (IDN13, bit 6). This function is only active while the amplifier is in position control. The "In Position" flag may be selected as a RTS bit through IDN336 (refer to IDN159, 189, 336).

Data Length:	4 bytes	Non-Volatile:	Yes
Data Type:	Unsigned decimal	Write Access:	CP2, CP3, CP4
Minimum:		Run-Up Check:	
Maximum:		Cyclic Transfer:	
Default:	0x0h	ASCII Param.:	INPOS
Units:	IDN76, 77, 78, 79, 123	Version:	

3.50 IDN59 Position Switch Flag Parameter

The position switch flag parameter depends on

- the position feedback value
- the settings of the "Position Switch Polarity Parameter" (IDNP3043)
- the "Type of Position Switch Parameter" (IDNP3044).

The behavior of the position switch flag bits are described below (please refer also to the IDNs P3041 and P3044).

The corresponding bits of IDNP3043 and IDNP3044 are set to "0", which is the default.

Then the associated flag bit is set to "0" if the position feedback value is smaller than the position switching point.

The associated flag is set to "1" if the position feedback value is greater than or equal to the position switching point.

The corresponding bits of IDNP3043 is set to "1" and of IDNP3044 is set to "0".

Then the associated flag bit is set to "1" if the position feedback value is smaller than the position switching point.

The associated flag is set to "0" if the position feedback value is greater than or equal to the position switching point.

If the corresponding bit of IDNP3044 is set to "1", then the associated flag is checked once according to the polarity setting of IDNP3043 and latched till the associated flag is enabled again.

Bit	Description
LSB 0	Position switch point 1 (IDN60)
1	Position switch point 2 (IDN61)
2	Position switch point 3 (IDN62)
3	Position switch point 4 (IDN63)
4	Position switch point 5 (IDN64)
5	Position switch point 6 (IDN65)
6	Position switch point 7 (IDN66)
7	Position switch point 8 (IDN67)
8 - 15	Reserved.

A positioning switch point can also be indicated via digital outputs (see P3005...8).

Data Length:	2 bytes	Non-Volatile:	No
Data Type:	Binary	Write Access:	Read-only
Minimum:	0x0000h	Run-Up Check:	
Maximum:	0x00FFh	Cyclic Transfer:	AT
Default:		ASCII Param.:	M POSRSTAT

3.51 IDN60..67 Position Switch Point 1..8

Each position switch point IDN defines a feedback position that determines the state of a corresponding position status flag within IDN59 (refer to IDN59).

Data Length:	4 bytes	Non-Volatile:	Yes
Data Type:	Signed decimal	Write Access:	CP2, CP3, CP4
Minimum:		Run-Up Check:	
Maximum:		Cyclic Transfer:	MDT (60, 61, 62, 63, 64, 66)
Default:	0	ASCII Param.:	P1, P2, P3, P4, P5, P6, P7 and P8
Units:	IDN76, 77, 78, 79, 123	Version:	

3.52 IDN76 Position Data Scaling Type

Defines the scaling options for all position data. The supported scaling types are:

Preferred Scaling: Fixed velocity data scaling (IDN45 = 1, IDN46 = -4)
Fixed position data scaling (IDN77 = 1, IDN78 = -7)

Parameter Scaling: Adjustable velocity data scaling (IDN44, 45, 46)
Adjustable position data scaling (IDN77, 78)

IDN76	Scaling method	Scaling type	Data reference
0x0001h	linear scaling	Preferred Scaling	Motor Shaft
0x0002h	rotational scaling	Preferred Scaling	Motor Shaft
0x000Ah	rotational scaling	Parameter Scaling	Motor Shaft
0x0041h*	linear scaling	Preferred Scaling	Load
0x0049h	no function		
0x004Ah	rotational scaling	Parameter Scaling	Load

* not possible, if IDN33 = external encoder.

Linear scaling and Modulo exclude each other. With linear scaling, the software limit switches are automatically switched on (refer to IDN49, 50, 55 and P3004).

If rotational scaling is selected and the rotational position resolution (IDN79) is different from the internal scaling (2^{PRBASE}), the modulo format must be switched on, this will be done during run-up.

With set the operation mode within IDN32 or 33 to position control with external feedback, this IDN will set to 004A(Hex) as a fixed setting. The amplifier can only operate with a fixed rotational scaling for the position data in this case (refer to IDN79).

Bit		Value	Description
2 - 0	Scaling Method	000	
		001	Linear Scaling
		010	Rotational Scaling
3	Standard Scaling Type	0	Preferred Scaling
		1	Parameter Scaling
4	Reserved: Units for Linear Scaling	0	Meters (m)
		1	
4	Units for Rotational Scaling	0	Degrees
		1	
5	Reserved		
6	Data Reference	0	At the Motor Shaft
		1	At the Load (Only for rotational scaling)
7	Processing Format*	0	Absolute Format
		1	Modulo Format (See IDN103)
15-8	Reserved.		

* A change of bit 7 will initiate a warmstart procedure (refer to IDN128) during run-up. The amplifier's display will show three flashing dots for up to 30s while startup configuration is updated.

Data Length:	2 bytes	Non-Volatile:	Yes
Data Type:	Binary	Write Access:	CP2 (amplifier disabled)
Minimum:	0x0001h	Run-Up Check:	CP3
Maximum:	0x008Ah	Cyclic Transfer:	
Default:	0x000Ah	ASCII Param.:	SERCSET (Bits 24 - 31)

3.53 IDN77 Linear Position Data Scaling Factor

This parameter defines the scaling factor for all position data in the amplifier, when linear scaling is selected in IDN76.

$$LSBWeight = factor(IDN77) \cdot 10^{\text{exponent}(IDN78)} \{m\} = 1 \cdot 10^{-7} m$$

Data Length:	2 bytes	Non-Volatile:	No
Data Type:	Unsigned decimal	Write Access:	read-only
Minimum:	1	Run-Up Check:	
Maximum:	100	Cyclic Transfer:	
Default:	1 (fix)	ASCII Param.:	
Units:		Version:	

3.54 IDN78 Linear Position Data Scaling Exponent

This parameter defines the scaling exponent for all position data in the amplifier, when linear scaling in IDN76 is selected. Refer to IDN77.

Data Length:	2 bytes	Non-Volatile:	No
Data Type:	Signed decimal	Write Access:	read-only
Minimum:	-7	Run-Up Check:	
Maximum:	-3	Cyclic Transfer:	
Default:	-7 (fix)	ASCII Param.:	
Units:		Version:	

3.55 IDN79 Rotational Position Resolution

This parameter defines the rotational position resolution for all position data in the amplifier. The LSB weight of rotational position data is determined by the following equation:

$$LSBWeight = \frac{360^\circ}{IDN79}$$

If the rotational position resolution is different from the internal resolution of the amplifier (2^{PRBASE}), it is necessary that the modulo format is switched on in IDN76. Only the values 2^x can be saved in the non-volatile memory with $x=\{16...28\}$.

By using parameter 121 (Input revolutions of load gear) und 122 (Output revolutions of load gear) the minimum changes to

$$\text{min: } 100 * (IDN122/IDN121)$$

and the maximum to

$$\text{max: } 2^{28} * (IDN122/IDN121)$$

Data Length:	4 bytes	Non-Volatile:	Yes
Data Type:	Unsigned decimal	Write Access:	CP2
Minimum:	100	Run-Up Check:	
Maximum:	268 435 456 (2^{28})	Cyclic Transfer:	
Default:	1048576	ASCII Param.:	log(PRBASE)
Units:	Counts / Revolution	Version:	

3.56 IDN80 Torque Setpoint Value

The master issues torque setpoints to the amplifier as cyclic data through IDN80. Torque setpoints written via the service channel do not take affect.

Data Length:	2 bytes	Non-Volatile:	No
Data Type:	Signed decimal	Write Access:	CP2, CP3, CP4
Minimum:		Run-Up Check:	
Maximum:		Cyclic Transfer:	MDT, AT
Default:		ASCII Param.:	ICMD x (1000 / MICONT)
Units:	IDN86	Version:	

3.57 IDN81 Additive Torque Setpoint

The master issues additive torque commands to the amplifier as cyclic data via IDN81.

Values written via the service channel do not have any effect. This is an additional function, which is used to influence the torque in the drive in order to minimize following errors. This value is added to the torque command. This function can be used for position and speed control. It should not be set together with automatic acceleration feed forward P-IDN 3052, since both functions write the internal variable "IVORCMD" (see also IDN P3052).

Data Length:	2 bytes	Non-Volatile:	No
Data Type:	Signed decimal	Write Access:	CP2, CP3, CP4
Minimum:	-2^{15}	Run-Up Check:	
Maximum:	$2^{15} - 1$	Cyclic Transfer:	MDT
Default:		ASCII Param.:	M IVORCMD
Units:	IDN86	Version:	

3.58 IDN84 Torque Feedback Value

The master controller retrieves the motor's torque feedback from the amplifier through IDN84.

Data Length:	2 bytes	Non-Volatile:	No
Data Type:	Signed decimal	Write Access:	Read-only
Minimum:		Run-Up Check:	
Maximum:		Cyclic Transfer:	AT
Default:		ASCII Param.:	I x (1000 / MICONT)
Units:	IDN86	Version:	

3.59 IDN86 Torque/Force Data Scaling Type

Defines the scaling options for all torque or force data. The weight of the LSB for percentage scaling is defined as 0.1% of the motor's continuous current (IDN111).

Data Length:	2 bytes	Non-Volatile:	Fix
Data Type:	Binary	Write Access:	Read-only
Minimum:	0	Run-Up Check:	
Maximum:	0	Cyclic Transfer:	
Default:	0 Percentage Scaling	ASCII Param.:	

3.60 IDN88 Receive to Receive Recovery Time

The time required by the amplifier between the end of the MDT and the beginning of the MST.

Data Length:	2 bytes	Non-Volatile:	Fix
Data Type:	Unsigned decimal	Write Access:	Read-only
Minimum:		Run-Up Check:	
Maximum:		Cyclic Transfer:	
Default:	50	ASCII Param.:	
Units:	μ s	Version:	

3.61 IDN89 MDT Transmission Starting Time

The time at which the master should transmit the MDT, after the end of the MST, during CP3 and CP4. The MDT Transmission Starting Time must be downloaded from the master during CP2. The “MDT Transmission Starting Time” is limited by the CCT (IDN2), the “Transmit/Receive Transmission Time” (IDN4) the “AT Transmission Starting Time” (IDN6) and the “Receive to Receive Recovery Time” (IDN88) according to the following restrictions.

$$\text{IDN89} \geq \text{IDN6} + \text{AT Transmission Time} + \text{AT Jitter} + \text{IDN4} + \text{MDT Jitter}$$

$$\text{IDN89} \leq \text{IDN2} - \text{max IDN88 from all amplifiers} - \text{MDT Transmission Time} - \text{MST Transmission Time} - \text{MDT Jitter} - \text{CCT Jitter}$$

Data Length:	2 bytes	Non-Volatile:	No
Data Type:	Unsigned decimal	Write Access:	CP2
Minimum:		Run-Up Check:	CP2
Maximum:		Cyclic Transfer:	
Default:	None	ASCII Param.:	
Units:	µs	Version:	

3.62 IDN90 Setpoint Value Processing Time

The minimum time required by the amplifier from the end of the MDT to the point at which the received setpoint values may be used by the amplifier.

Data Length:	2 bytes	Non-Volatile:	Fix
Data Type:	Unsigned decimal	Write Access:	Read-only
Minimum:		Run-Up Check:	
Maximum:		Cyclic Transfer:	
Default:	50	ASCII Param.:	
Units:	µs	Version:	

3.63 IDN91 Bipolar Velocity Limit

Establishes the maximum acceptable velocity setpoint in both the clockwise and counter-clockwise directions. In velocity mode and during homing, velocity setpoints that exceed the bipolar velocity limit are clamped to the velocity limit. In position mode, the velocity is monitored, and if the velocity exceeds the bipolar velocity limit, a fault is generated (IDN129, bit 9).

The “Bipolar Velocity Limit” (IDN91) is linked to the “Positive and Negative Velocity Limit Values” (IDN38 and IDN39). If the values in IDN38 and IDN39 are larger than IDN91, then IDN91 limits IDN38 and IDN39 to IDN91.

If the value in IDN91 is , the same value is also written to IDN38 and IDN39 (with the appropriate signs). IDN38 and IDN39 must have the same absolute value in order for IDN91 to be valid. If they do not have the same absolute value when IDN91 is read, then the amplifier will return error message 7008, “Invalid Data” for IDN91.

Data Length:	4 bytes	Non-Volatile:	Yes
Data Type:	Signed decimal	Write Access:	CP2, CP3, CP4
Minimum:	0	Run-Up Check:	
Maximum:	IDN113	Cyclic Transfer:	
Default:	3000 RPM	ASCII Param.:	VLIM
Units:	IDN44,45,46 Default: RPM * 10 000	Version:	

3.64 IDN92 Bipolar Torque Limit

Defines the maximum torque limit in both the clockwise and counter-clockwise directions.

Data Length:	2 bytes	Non-Volatile:	Yes
Data Type:	Unsigned decimal	Write Access:	CP2, CP3, CP4
Minimum:	0	Run-Up Check:	
Maximum:	Minimum of IDN109 (I _{peak} motor) and IDN110 (I _{peak} amplifier)	Cyclic Transfer:	MDT
Default:	Minimum of IDN109 (I _{peak} motor) and IDN110 (I _{peak} amplifier)	ASCII Param.:	IPEAK, IPEAKN
Units:	IDN86 Scaling type for torque/force data	Version:	

3.65 IDN93 Scaling Factor Torque

Defines the scaling factor for all torque data in the amplifier. See IDN86.

Data Length:	2 bytes	Non-Volatile:	Fix
Data Type:	Unsigned decimal	Write Access:	read-only
Minimum:	1	Run-Up Check:	
Maximum:	1	Cyclic Transfer:	
Default:	1	ASCII Param.:	

3.66 IDN94 Scaling Exponent Torque

Defines the scaling exponent for all torque data in the amplifier. See IDN86.

Data Length:	2 bytes	Non-Volatile:	No
Data Type:	Unsigned decimal	Write Access:	read-only
Minimum:	0	Run-Up Check:	
Maximum:	0	Cyclic Transfer:	
Default:	0	ASCII Param.:	

3.67 IDN95 Diagnostic Message

The master can read a text message that describes the status of the amplifier.

Data Length:	1 byte elements, variable length array	Non-Volatile:	Fix
Data Type:	Text	Write Access:	Read-only
Minimum:		Run-Up Check:	
Maximum:		Cyclic Transfer:	
Default:		ASCII Param.:	SSTAT

3.68 IDN96 Slave Arrangement

The SERCOS address of the amplifier is contained in both the upper and lower bytes of this IDN.

Example: ADDR (ADDRFB with S400) = 3
 IDN96 = 0x0303h

Data Length:	2 bytes	Non-Volatile:	Yes
Data Type:	Hexadecimal	Write Access:	Read-only
Minimum:		Run-Up Check:	
Maximum:		Cyclic Transfer:	
Default:		ASCII Param.:	ADDR (ADDRFB with S400)

3.69 IDN97 Class 2 Diagnostic Mask

Warnings for masked bits are not indicated in C2D (AT status word, bit 12).

A mask for the C2D (AT status word, bit 12), amplifier warning. When a warning condition within IDN12 changes state, the C2D change bit (AT status word, bit 12) is set.

The warning bits within IDN12 are not latched (i.e. they will automatically set or reset as warning conditions change). The C2D change bit is reset when IDN12 is read through the service channel.

IDN97 may be used to mask the effect of a particular warning condition on the C2D change bit in the AT status word. When a masked warning changes state, the C2D change bit in the AT status word will not be set. However, the warning bits in IDN12 will continue to change state according to the warning conditions. When a bit in IDN97 is clear, the corresponding bit in IDN12 is masked.

Data Length:	2 bytes	Non-Volatile:	No
Data Type:	Binary	Write Access:	CP2, CP3, CP4
Minimum:		Run-Up Check:	
Maximum:		Cyclic Transfer:	
Default:	0b xxxx xxxx 1111 1111	ASCII Param.:	BUSP0 (lower 16 bits)

3.70 IDN98 Class 3 Diagnostic Mask

Warnings for masked bits are not indicated in C3D (AT status word, bit 11).

A mask for the C3D (IDN13). When a warning condition within IDN13 changes state, the C3D change bit (AT status word, bit 11) is set.

The warning bits within IDN13 are not latched (i.e. they will automatically set or reset as warning conditions change). The C3D change bit is reset when IDN13 is read through the service channel.

IDN98 may be used to mask the effect of a particular warning condition on the C3D change bit in the AT status word. When a masked warning changes state, the C3D change bit in the AT status word will not be set. However, the warning bits in IDN13 will continue to change state according to the warning conditions. When a bit in IDN98 is clear, the corresponding bit in IDN13 is masked.

Data Length:	2 bytes	Non-Volatile:	No
Data Type:	Binary	Write Access:	CP2, CP3, CP4
Minimum:		Run-Up Check:	
Maximum:		Cyclic Transfer:	
Default:	0b1111 1111 xxxx xxxx	ASCII Param.:	BUSP0 (upper 16 bits)

3.71 IDN99 Command: Reset Class 1 Diagnostic (clear fault)

The latched faults contained in IDN11, IDN14 and IDN129 are cleared, if the causes for the faults have been repaired. If all the faults are cleared successfully, the C1D status bit (AT bit 13) is also cleared. The fault reset procedure will fail if faults have been latched and the master has not reset the amplifier enable control bits (MDT bits 13-15).

Some faults specified in IDN11 and IDN129 (e.g. faulty feedback, faulty commutation, for details see ASCII – Command ERRCODE) require a coldstart, which IDN99 performs automatically when required. The SERCOS ring is thus automatically reset to phase 0. Other amplifiers respond to this according to the standard with error message F29 “SERCOS fault” (see also IDNP3016).

The IDN99 procedure will not reset faults if MDT controlword bits 14 and 15 are set during CP4.

Data Length:	2 bytes	Non-Volatile:	No
Data Type:	Binary	Write Access:	CP2, CP3, CP4
Minimum:		Run-Up Check:	
Maximum:		Cyclic Transfer:	
Default:	0	ASCII Param.:	

3.72 IDN100 Velocity Loop Proportional Gain

Proportional Gain for the proportional-integral velocity loop controller. If the gain is too low, then the amplifier may respond slowly or have poor damping. If the value is too high, then the amplifier may whistle or oscillate.

Data Length:	2 bytes	Non-Volatile:	Yes
Data Type:	Unsigned decimal	Write Access:	CP2, CP3, CP4
Minimum:	0.01	Run-Up Check:	
Maximum:	3692	Cyclic Transfer:	
Default:	0.46	ASCII Param.:	GV * 100

3.73 IDN101 Velocity Loop Integral Action Time

The integral action time for the proportional-integral velocity loop controller. With IDN101=0, the integrator is switched off. If the value is too low, then the amplifier may run roughly or may oscillate. If the value is too high, the amplifier response may be sluggish.

Data Length:	2 bytes	Non-Volatile:	Yes
Data Type:	Unsigned decimal	Write Access:	CP2, CP3, CP4
Minimum:	0, IDN 100 / 625	Run-Up Check:	
Maximum:	1000.0	Cyclic Transfer:	
Default:	10	ASCII Param.:	GVTN * 10
Units:	0.1 ms	Version:	

3.74 IDN103 Modulo Value

If the modulo format is on (IDN76 bit 7 = 1), the modulo value determines at which numeric value the position data switch back to the start value. The following conditions for the modulo value will check during run-up:

1. If linear scaling and modulo format is selected within IDN76 and the feed constant IDN123 is smaller than 2^{20} , IDN103 must be smaller than $2^{10} * IDN123$.
2. If rotational scaling and modulo format is selected within IDN76 and rotational position resolution IDN79 is smaller than 2^{20} , IDN103 must be smaller than $2^{10} * IDN79$.
3. If rotational scaling and modulo format is selected within IDN76 and rotational position resolution IDN79 is greater than 2^{20} , IDN103 must be smaller than $2^{20} / IDN79$.
4. The modulo value and the current position resolution must be dividable without remainder.

Data Length:	4 bytes	Non-Volatile:	Yes
Data Type:	Unsigned decimal	Write Access:	CP2, CP3
Minimum:	1	Run-Up Check:	CP3
Maximum:	$2^{31}-1$	Cyclic Transfer:	
Default:	$2^{31}-1$	ASCII Param.:	ERND / SRND
Units:	IDN76, 77, 78, 79, 123	Version:	

3.75 IDN104 Position Loop Proportional Gain

The proportional gain for the proportional position loop controller. If the gain is too low, then the drive may respond with a time lag or have poor damping. If the value is too high, then the drive may whistle or oscillate.

Data Length:	2 bytes	Non-Volatile:	Yes
Data Type:	Unsigned decimal	Write Access:	CP2, CP3, CP4
Minimum:	60	Run-Up Check:	
Maximum:	60000	Cyclic Transfer:	
Default:	900	ASCII Param.:	GP * 6000
Units:	0.01 (m/min)/mm ≡ 0.01 (in/min)/mil ≡ 0.01 (kRPM)/rev	Version:	

3.76 IDN105 Position Loop Integral Action Time

The integral time for the proportional-integral position loop controller.

Data Length:	2 bytes	Non-Volatile:	Yes
Data Type:	Unsigned decimal	Write Access:	CP2, CP3, CP4
Minimum:	10	Run-Up Check:	
Maximum:	2000	Cyclic Transfer:	
Default:	500	ASCII Param.:	GPTN * 10
Units:	0.1 ms	Version:	

3.77 IDN106 Current Loop Proportional Gain 1

The proportional gain for the torque producing current (D) within the proportional-integral current loop controller.

Data Length:	2 bytes	Non-Volatile:	Yes
Data Type:	Unsigned decimal	Write Access:	CP2, CP3, CP4
Minimum:	0.001	Run-Up Check:	
Maximum:	1.5	Cyclic Transfer:	
Default:	0.1	ASCII Param.:	MLGQ * 100
Units:		Version:	

3.78 IDN107 Current Loop Integral Action Time 1

The integral time for the torque producing current within the proportional-integral current loop controller.

Data Length:	2 bytes	Non-Volatile:	Yes
Data Type:	Unsigned decimal	Write Access:	CP2, CP3, CP4
Minimum:	200	Run-Up Check:	
Maximum:	10000	Cyclic Transfer:	
Default:	600	ASCII Param.:	KTN * 1000
Units:	µs	Version:	

3.79 IDN108 Feedrate Override

The feedrate override is activated only with amplifier-controlled procedure commands. The velocity setpoint is then calculated by the amplifier internally. IDN108 has a multiplying effect on the velocity setpoint value.

Data Length:	2 bytes	Non-Volatile:	No
Data Type:	Unsigned decimal	Write Access:	CP2, CP3, CP4
Minimum:	0	Run-Up Check:	
Maximum:	10000	Cyclic Transfer:	
Default:	10000	ASCII Param.:	OVERRIDE * 625 / 512
Units:	0.01%	Version:	

3.80 IDN109 Motor Peak Current

If the motor peak current is less than that of the amplifier, the amplifier is automatically limited to the level of the motor peak current.

Data Length:	4 bytes	Non-Volatile:	Yes
Data Type:	Unsigned decimal	Write Access:	CP2, CP3
Minimum:	0.1 * IDN110	Run-Up Check:	
Maximum:	2 * IDN110	Cyclic Transfer:	
Default:	IDN110	ASCII Param.:	MIPEAK * 1000
Units:	mA	Version:	

3.81 IDN110 Amplifier Peak Current

This value is defined by the hardware.

Data Length:	4 bytes	Non-Volatile:	Yes
Data Type:	Unsigned decimal	Write Access:	Read-only
Minimum:		Run-Up Check:	
Maximum:		Cyclic Transfer:	
Default:	Hardware defined	ASCII Param.:	DIPEAK * 1000
Units:	mA	Version:	

3.82 IDN111 Motor Continuous Stall Current

This parameter is used as a reference for all torque data and for determining motor-related current values from torque data.

Data Length:	4 bytes	Non-Volatile:	Yes
Data Type:	Unsigned decimal	Write Access:	CP2, CP3
Minimum:	0.1 * IDN112	Run-Up Check:	
Maximum:	2.0 * IDN112	Cyclic Transfer:	
Default:	IDN112	ASCII Param.:	MICONT * 1000
Units:	mA	Version:	

3.83 IDN112 Amplifier Rated Current

This hardware-defined variable is automatically determined by the amplifier.

Data Length:	4 bytes	Non-Volatile:	Yes
Data Type:	Unsigned decimal	Write Access:	Read-only
Minimum:		Run-Up Check:	
Maximum:		Cyclic Transfer:	
Default:	Hardware defined	ASCII Param.:	DICONT
Units:	mA	Version:	

3.84 IDN113 Maximum Motor Speed

The motor's maximum recommended speed, as listed in the motor specification sheet provided by the manufacturer.

Data Length:	4 bytes	Non-Volatile:	Yes
Data Type:	Unsigned decimal	Write Access:	CP2, CP3
Minimum:	0	Run-Up Check:	
Maximum:	12000 RPM	Cyclic Transfer:	
Default:	3000 RPM	ASCII Param.:	MSPEED
Units:	IDN44,45,46 (Default: RPM / 10000)	Version:	

3.85 IDN114 System Load Limit

The system's continuous load rating. The continuous load rating is defined as a percentage of the system's continuous current. When the load limit is exceeded, the amplifier sets the overload warning bit in the C2D (IDN12, bit 0).

Data Length:	2 bytes	Non-Volatile:	Yes
Data Type:	Unsigned decimal	Write Access:	CP2, CP3, CP4
Minimum:	0	Run-Up Check:	
Maximum:	100	Cyclic Transfer:	
Default:	80	ASCII Param.:	I2TLIM
Units:	% of min (IDN111, 112, or P3020)	Version:	

3.86 IDN116 Resolution of Rotational Feedback 1 (Motor Feedback)

The motor's rotary feedback resolution (refer to IDN79).

Data Length:	4 bytes	Non-Volatile:	Yes
Data Type:	Unsigned decimal	Write Access:	Read-only
Minimum:	65536	Run-Up Check:	
Maximum:	1048576	Cyclic Transfer:	
Default:	1048576	ASCII Param.:	2 ^{PRBASE}
Units:	Counts	Version:	

3.87 IDN117 Resolution of Rotational Feedback 2 (External Feedback)

The resolution of the external feedback 2 contains the cycles per revolution of an external feedback (IDN53). The resolution of the external position feedback depends on this parameter and the multiplication factor 2 (IDN257).

resolution = external feedback (IDN117) x 4 x multiplication factor 2 (IDN257)

The maximum resolution is set within IDN79 divide by 4, the amplifier checks during run-up, that the setting will not give a bigger value. In this case the amplifier automatically calculates a new multiplication factor 2 (IDN257).

Data Length:	4 bytes	Non-Volatile:	Yes
Data Type:	Unsigned decimal	Write Access:	CP2
Minimum:	12	Run-Up Check:	
Maximum:	262144 (16384)	Cyclic Transfer:	
Default:	0	ASCII Param.:	FB2RES
Units:	Lines per revolution	Version:	

3.88 IDN119 Current Loop Proportional Gain 2

The proportional gain for the field-producing current (D) within the proportional-integral current loop controller. The parameter specifies the relative gain in reference to MLGQ (see also IDN106). 60 indicates that the gain of the D current controller is 60% of MLGQ.

Data Length:	2 bytes	Non-Volatile:	Yes
Data Type:	Unsigned decimal	Write Access:	Read-only
Minimum:	1	Run-Up Check:	
Maximum:	3 000	Cyclic Transfer:	
Default:	100	ASCII Param.:	MLGQ * 100

3.89 IDN120 Current Loop Integral Action Time 2

The integral time for the field-producing current within the proportional-integral current loop controller. See IDN 107.

Data Length:	2 bytes	Non-Volatile:	Yes
Data Type:	Unsigned decimal	Write Access:	Read-only
Minimum:	200	Run-Up Check:	
Maximum:	10 000	Cyclic Transfer:	
Default:	600	ASCII Param.:	KTN * 1000
Units:	µs	Version:	

3.90 IDN121 Input Revolutions of Load Gear

Input revolution values must be entered as integers. The relation between IDN121 and 122 can be between 0.01 and 100.

$$\text{Gear ratio} = \frac{\text{Input revolution (IDN121)}}{\text{Output revolutions (IDN122)}}$$

Basic Example for Ratio 1

100 = 100 motor revolutions per revolution at the load.

Basic Example for Ratio 2

0.01 = 1 motor revolution per 100 revolutions at the load.

For example:

Motor: 770 rpm, load 17.5 rpm => gear ratio = 42.5 and is therefore within the permissible range.

The IDNs would have the following settings, for example: IDN 121 = 85, IDN 122 = 2.

Data Length:	4 bytes	Non-Volatile:	Yes
Data Type:	Unsigned decimal	Write Access:	CP2, CP 3
Minimum:	IDN122 / 100	Run-Up Check:	
Maximum:	IDN122 * 100	Cyclic Transfer:	
Default:	1	ASCII Param.:	FB_ACCFDIV

3.91 IDN122 Output Revolutions of Load Gear

Output revolution values must be entered as integers.

The relation between IDN121 and 122 can be between 0.01 and 100 (⇒ IDN 121).

Data Length:	4 bytes	Non-Volatile:	Yes
Data Type:	Unsigned decimal	Write Access:	CP2, CP 3
Minimum:	IDN121 / 100	Run-Up Check:	
Maximum:	IDN121 * 100	Cyclic Transfer:	
Default:	1	ASCII Param.:	FB_ACCFNUM

3.92 IDN123 Feed Constant

The feed constant describes the machine element which converts a rotational motion into a linear motion. IDN123 indicates the linear distance during one revolution of the feed spindle. This IDN is only active when linear scaling in IDN76 is selected. This IDN also describes the feed at linear rotational speed scaling.

By using parameter 121 and 122 the minimum changes to min: 100 x (IDN122/IDN121)
and the maximum to max: 100,000,000 x
(IDN122/IDN121)

Data Length:	4 bytes	Non-Volatile:	No
Data Type:	Unsigned decimal	Write Access:	CP2
Minimum:	100	Run-Up Check:	
Maximum:	10,000,000	Cyclic Transfer:	
Default:	100,000	ASCII Param.:	FB_LTF
Units:	IDN76, 77, 78	Version:	

3.93 IDN126 Torque treshold Tx

Threshold for IDN333.

Data Length:	2 bytes	Non-Volatile:	No
Data Type:	Unsigned decimal	Write Access:	CP2
Minimum:		Run-Up Check:	
Maximum:		Cyclic Transfer:	
Default:		ASCII Param.:	
Units:	IDN86	Version:	

3.94 IDN127 Command: Communication Phase 3 Transition Check

Ensures that the amplifier is ready to switch from CP2 to CP3. The master must successfully execute this procedure prior to switching from CP2 to CP3. If the procedure fails, IDN21 will contain a list of IDNs that the amplifier considers invalid.

Data Length:	2 bytes	Non-Volatile:	No
Data Type:	Binary	Write Access:	CP2
Minimum:		Run-Up Check:	
Maximum:		Cyclic Transfer:	
Default:	0	ASCII Param.:	

3.95 IDN128 Command: Communication Phase 4 Transition Check

Ensures that the amplifier is ready to switch from CP3 to CP4. The master must successfully execute this procedure prior to switching from CP3 to CP4. If the procedure fails, IDN22 will contain a list of IDNs that the amplifier considers invalid.

If any of the macros have been changed in CP2 or CP3, the amplifier will re-compile the macro program and perform a warmstart, which may take up to 3 minutes. During the warmstart, the LED on the front panel of the amplifier add with the three dots will flashing. During the warmstart IDN182 Bit 1 is set, it will cleared after the warmstart.

Alternatively, the serial interface may be used to save all values and reset the amplifier before the CP4 transition check procedure is executed.

Data Length:	2 bytes	Non-Volatile:	No
Data Type:	Binary	Write Access:	CP3
Minimum:		Run-Up Check:	
Maximum:		Cyclic Transfer:	
Default:	0	ASCII Param.:	

3.96 IDN129 Manufacturer Class 1 Diagnostic (MC1D)

Lists the status of the latched manufacturer-defined amplifier faults. In this fault situation the amplifier decelerates to a stop and disables. The C1D status bit (AT status bit 13) is set, IDN11 bit 15 (manufacturer status class C1D / manufacturer specific fault) is set, and the corresponding manufacturer-defined fault bit is set within IDN129.

Refer to IDN11 and IDN99.

Bit	Description	Coldstart	Error
LSB 0	AS (restart lock)	yes	F27
1	Non-volatile memory checksum fault	yes	F09, F10
2	Warning-Fault (actual warning is mask to a fault)	no	F24
3	Motor holding brake fault	yes	F11
4	Supply voltage not present	no	F16
5	A/D converter fault	yes	F17
6	Regen fault	yes	F18
7	System fault	yes	F32
8	Macro fault	no	F31
9	Motor overspeed fault	no	F08
10	Excessive position setpoint difference	No	F28
11	Impermissible software-enable (no hardware-enable), refer to IDNP3028	No	F29
12 - 15			

Data Length:	2 bytes	Non-Volatile:	No
Data Type:	Binary	Write Access:	Read-only
Minimum:		Run-Up Check:	
Maximum:		Cyclic Transfer:	
Default:	0	ASCII Param.:	ERRCODE

3.97 IDN130 Probe 1 Positive Edge Value

The “Probing” procedure (IDN170) is used to capture a position when a digital input changes. IDN130 will contain the captured position when the “Probe Control Parameter” (IDN169, bit 0) is configured for probe 1 to capture the position on the rising edge of the digital input. Selection of the source of the position information ⇒ IDNP 3018.

Data Length:	4 bytes	Non-Volatile:	No
Data Type:	Signed decimal	Write Access:	Read-only
Minimum:		Run-Up Check:	
Maximum:		Cyclic Transfer:	AT
Default:		ASCII Param.:	LATCH32
Units:	IDN76, 77, 78, 79, 123	Version:	

3.98 IDN131 Probe 1 Negative Edge Value

The “Probing” procedure (IDN170) is used to capture a position when a digital input changes. IDN131 will contains the captured position when the “Probe Control Parameter” (IDN169, bit 1) is configured for probe 1 to capture the position on the falling edge of the digital input. Selection of the source of the position information ⇒ IDNP 3018.

Data Length:	4 bytes	Non-Volatile:	No
Data Type:	Signed decimal	Write Access:	Read-only
Minimum:		Run-Up Check:	
Maximum:		Cyclic Transfer:	AT
Default:		ASCII Param.:	LATCH32N
Units:	IDN76, 77, 78, 79, 123	Version:	

3.99 IDN132 Probe 2 Positive Edge Value

The “Probing” procedure (IDN170) is used to capture a position when a digital input changes. IDN132 will contains the captured position when the “Probe Control Parameter” (IDN169, bit 2) is configured for probe 2 to capture the position on the rising edge of the digital input. Selection of the source of the position information ⇒ IDNP 3018.

Data Length:	4 bytes	Non-Volatile:	No
Data Type:	Signed decimal	Write Access:	Read-only
Minimum:		Run-Up Check:	
Maximum:		Cyclic Transfer:	AT
Default:		ASCII Param.:	LATCHX32
Units:	IDN76, 77, 78, 79, 123	Version:	

3.100 IDN133 Probe 2 Negative Edge Value

The “Probing” procedure (IDN170) is used to capture a position when a digital input changes. IDN133 will contains the captured position when the “Probe Control Parameter” (IDN169, bit 3) is configured for probe 2 to capture the position on the falling edge of the digital input. Selection of the source of the position information ⇒ IDNP 3018.

Data Length:	4 bytes	Non-Volatile:	No
Data Type:	Signed decimal	Write Access:	Read-only
Minimum:		Run-Up Check:	
Maximum:		Cyclic Transfer:	AT
Default:		ASCII Param.:	LATCHX32N
Units:	IDN76, 77, 78, 79, 123	Version:	

3.101 IDN134 Master Control Word

The amplifier's control word within the MDT is stored within IDN134 as a diagnostic aid. More detailed information can be found in the SERCOS standards (see MDT Control Bit 13-15 ⇒ p. 17).

Data Length:	2 bytes	Non-Volatile:	No
Data Type:	Binary	Write Access:	Read-only
Minimum:		Run-Up Check:	
Maximum:		Cyclic Transfer:	

Control word, length: two bytes

Bit No.	Control word description
Bits 15-13	
1 1 1	Amplifier should follow the setpoints
Bit 15 (MSB)	Amplifier ON/OFF
0	Amplifier OFF
1	Amplifier ON: when changing from 0 → 1: drive follows the master's setpoints
Bit 14	Enable amplifier
0	Not enabled: when changing from 1 → 0, torque is immediately disabled and the power stage pulses are blocked (independent of bits 15 and 13).
1	Enable Amplifier : when changing from 0 → 1, the enable is delayed in the amplifier by the amplifier enable delay time.
Bit 13	Halt/Restart Amplifier
0	Halt Amplifier : when changing from 1 → 0, amplifier is halted according to the „amplifier acceleration bipolar“ parameter and the control loop remains closed (only possible when bits 15 and 14 are set to 1).
1	Restart Amplifier : when changing from 0 → 1, original function is continued. Only in velocity control the amplifier has to use the „amplifier acceleration bipolar“. In position control the control unit has to set the position setpoints to the position feedback value before bit 13 is set.
Bit 12	Reserved
Bit 10	IPOSYNC: Control unit synchronization bit , not supported
Bits 11,9, 8	Operation mode
0 0 0	Primary operation mode (defined by operation data IDN32).
0 0 1	Secondary operation mode 1 (defined by operation data IDN33)
0 1 0 ...1 1 1	not supported
Bit 7	Real-time control bit 2
Bit 6	Real-time control bit 1
Bits 5, 4, 3	Data block element
0 0 0	Service channel not active, close service channel or break active transmission
0 0 1	IDN of the operation data. Service channel is closed for the previous IDN and opened for a new IDN
0 1 0	Name of operation data
0 1 1	Attribute of operation data
1 0 0	Unit of the operation data
1 0 1	Minimum input value
1 1 0	Maximum input value
1 1 1	Operation data
Bit 2	
0	Transmission in progress
1	Last transmission
Bit 1	R/W (read/write)
0	Read service INFO
1	Write service INFO
Bit 0	MHS
0/1	Service transport handshake of the master

3.102 IDN135 Amplifier Status Word

The AT telegram status word is stored within IDN135 as a diagnostic aid.

Data Length:	2 bytes	Non-Volatile:	No
Data Type:	Binary	Write Access:	Read-only
Minimum:		Run-Up Check:	
Maximum:		Cyclic Transfer:	
Default:		ASCII Param.:	

Status word, length: two bytes

Bit No.	Status word description
Bits 15-14	Ready to operate
0 0	Amplifier not ready, internal checks not yet concluded successfully
0 1	Amplifier logic ready for main power on (power stage section)
1 0	Amplifier ready and main power applied, drive is free of torque, power stage pulses are blocked
1 1	Amplifier ready to operate, 'enable amplifier' is set and active. Power stage is active
Bit 13	Amplifier shut-down error in C1D (IDN11)
0	No shut-down
1	Amplifier is shut-down due to error
Bit 12	Change bit for C2D (IDN12)
0	No change
1	Change
Bit 11	Change bit for C3D (IDN13)
0	No change
1	Change
Bits 10, 9, 8	Actual operation mode
0 0 0	Primary operation mode (defined by IDN32)
0 0 1	Secondary operation mode 1 (defined by IDN33)
0 1 0 ... 1 1 1	not supported
Bit 7	Real-time status bit 2 (IDN306)
Bit 6	Real-time status bit 1 (IDN304)
Bit 5	Procedure command change bit
0	No change in procedure command acknowledgement
1	Changing procedure command acknowledgment
Bit 4	(Reserved)
Bit 3	not supported
Bit 2	Error in service channel
0	No error
1	Error in service channel, error message in amplifier service INFO
Bit 1	Busy
0	Step finished, ready for new step
1	Step in progress, new step not allowed
Bit 0	AHS
0/1	Service transport handshake of the amplifier

3.103 IDN136 Positive Acceleration Limit Value

Defines the amplifier's maximum positive acceleration when the amplifier is in velocity mode or position mode.

Data Length:	4 bytes	Non-Volatile:	Yes
Data Type:	Signed decimal	Write Access:	CP2, CP3, CP4
Minimum:	1	Run-Up Check:	
Maximum:	32767	Cyclic Transfer:	
Default:	10	ASCII Param.:	ACC
Units:	IDN160, 161, 162	Version:	

3.104 IDN137 Negative Acceleration Limit Value

Defines the amplifier's maximum deceleration (negative acceleration) when the amplifier is in velocity mode or position mode.

The amplifier alternatively uses the quick deceleration limit (IDNP3022) under the following conditions: position limits are encountered, a fault has occurred, or the master has requested an active disable (MDT control word, bit 15). The quick deceleration limit (IDNP3022) is always used by the amplifier when these conditions occur.

Data Length:	4 bytes	Non-Volatile:	Yes
Data Type:	Signed decimal	Write Access:	CP2, CP3, CP4
Minimum:	-32767	Run-Up Check:	
Maximum:	-1	Cyclic Transfer:	
Default:	-10	ASCII Param.:	DEC
Units:	IDN160, 161, 162	Version:	

3.105 IDN138 Bipolar Acceleration Limit Value

This parameter limits the acceleration symmetrically to the programmed value in both directions .

Data Length:	4 bytes	Non-Volatile:	Yes
Data Type:	Signed decimal	Write Access:	CP2, CP3, CP4
Minimum:	0	Run-Up Check:	
Maximum:	$2^{15} - 1$	Cyclic Transfer:	
Default:	10	ASCII Param.:	Busp8
Units:	IDN160, 161, 162	Version:	

3.106 IDN140 Controller Type

The operation data of the controller type contains the name of the company and the manufacturer's controller type. If necessary, the master can use this IDN to read the text description for the controller type. For example, with a SERVOSTAR 603, if IDN140 is read via the service channel, "SR 603" is returned.

Data Length:	1 byte elements, variable length array	Non-Volatile:	Yes
Data Type:	Text	Write Access:	Read-only
Minimum:		Run-Up Check:	
Maximum:		Cyclic Transfer:	
Default:		ASCII Param.:	HVER

3.107 IDN141 Motor Type

The master may use this IDN to read or write the motor type text describing. With IDNP 3046 the master can select the motor that is used from the motor database of the amplifier.

Data Length:	1 byte elements, variable length array	Non-Volatile:	Yes
Data Type:	Text	Write Access:	CP4
Minimum:		Run-Up Check:	
Maximum:		Cyclic Transfer:	
Default:	"NN"	ASCII Param.:	MNAME

3.108 IDN142 Application Type

The master may use this IDN to store text describing the amplifier's application.

Data Length:	1 byte elements, variable length array	Non-Volatile:	Yes
Data Type:	Text	Write Access:	CP2, CP3, CP4
Minimum:		Run-Up Check:	
Maximum:		Cyclic Transfer:	
Default:	"DRIVE0"	ASCII Param.:	ALIAS

3.109 IDN143 System Interface Version

Contains the version number of the SERCOS specification. The amplifier conforms this version of the specification.

Data Length:	1 byte elements, variable length array	Non-Volatile:	Yes
Data Type:	Text	Write Access:	Read-only
Minimum:		Run-Up Check:	
Maximum:		Cyclic Transfer:	
Default:	"V01.10"	ASCII Param.:	

3.110 IDN146 Command: NC-Controlled Homing

When the master sets and enables the control unit controlled homing procedure command, the servo amplifier reacts on the programmed or assigned signals (home switch IDN400, reference marker pulse of the feedback system). For more information see SERCOS Specification.

Data Length:	2 bytes	Non-Volatile:	No
Data Type:	Binary	Write Access:	CP4
Minimum:		Run-Up Check:	
Maximum:		Cyclic Transfer:	
Default:	0	ASCII Param.:	

3.111 IDN147 Homing Parameter

INFO

Using IDN147 and its configuration IDNs (41, 42) is SERCOS standard. The servo amplifier interprets these IDNs to set the ASCII parameter NREF (see IDNP3027). It's much easier to use IDNP3027 instead of setting IDN147 (and IDN41 and 42).

The "Amplifier-Controlled Homing" procedure (IDN148) is configured through IDN41, IDN42 and IDN147.

If command IDN148 is active, then IDN147 is write protected.

If the home switch is evaluated by the amplifier (bit 1=0 and bit 2=1), only the bits 0, 5 and 6 are supported.

All other reserved bits must be set as indicated within the following table. For the different homing types refer also to IDNP3027.

If the position control is set on the external feedback, bit 3 must be set to 1.

Bit	Description	Setting 0	Setting 1
LSB 0	Homing direction*	CW	CCW
1	Not supported	Set to 0	
2	Home switch location	Master	Amplifier
3	Feedback source	Motor	External
4	Home enable evaluation	Home switch+IDN407	IDN 407 only
5	Home switch evaluation	Evaluate	Not evaluated
6	Marker pulse evaluation	Evaluate	Not evaluated
7	Reserved: Stop condition	After position capture	On home position (IDN52,54)
8	Not supported	Set to 0	
9	To limit switch	Evaluate	Not evaluated
10	To mechanical stop with torque	Evaluate	Not evaluated
11 - 15	Reserved.	Set to 0	

* Direction as defined by IDNP3025. IDN55 defines direction from the Sercos master's view.

Data Length:	2 bytes	Non-Volatile:	Yes
Data Type:	Binary	Write Access:	CP2, CP3, CP4
Minimum:		Run-Up Check:	
Maximum:		Cyclic Transfer:	
Default:	0085h	ASCII Param.:	

3.112 IDN148 Command: Amplifier-Controlled Homing

The amplifier automatically enters an internal position mode and homes the amplifier. Homing is configured through the "Homing Velocity" (IDN41), "Homing Acceleration" (IDN42) and the "Homing Parameter" (IDN147/147 or IDNP3027).

Homing will fail under the following conditions:

- 1) The amplifier is disabled (Enable=0V), or the master clears any of the enable bits (MDT bits 13-15) during amplifier-controlled homing. With disabled amplifier you can start NREF 0, if the master has set MDT bit 13.
- 2) The "Probing" procedure (IDN170) is active.
- 3) The home switch is located on the amplifier (IDN147, bit 2 is set) and will be evaluated during homing (IDN147, bit 5 is clear) and a configurable input has not been configured as a home switch input.
- 4) A fault occurs during amplifier-controlled homing.

The master should not cancel the amplifier-controlled homing procedure until it has aligned its position setpoint with the amplifier's present position setpoint. The master controller may abort amplifier-controlled homing by first stopping the amplifier through the start/stop bit (MDT control bit 13), aligning its position setpoint with the amplifier and then canceling the procedure.

Data Length:	2 bytes	Non-Volatile:	No
Data Type:	Binary	Write Access:	CP4
Minimum:		Run-Up Check:	
Maximum:		Cyclic Transfer:	
Default:	0	ASCII Param.:	

3.113 IDN159 Monitoring Window

The monitoring window defines the maximum position error. When the absolute distance between the active position setpoint and active position feedback exceeds the monitoring window, an “excessive position deviation” fault F03 is generated (IDN11, bit 11).

Data Length:	4 bytes	Non-Volatile:	Yes
Data Type:	Signed decimal	Write Access:	CP2, CP3, CP4
Minimum:	0	Run-Up Check:	
Maximum:	$2^{31} - 1$	Cyclic Transfer:	
Default:	262144	ASCII Param.:	PEMAX
Units:	IDN76, 77, 78, 79, 123	Version:	

3.114 IDN160 Acceleration Data Scaling Type

Defines the scaling options for all acceleration data. For the no scaling option, all acceleration data are scaled in ms, to reach the bipolar velocity limit. A new value will not become active until the parameter is saved to non-volatile memory and a coldstart or warmstart (IDN128) procedure is initiated.

Bit		Description
2 - 0	Scaling Method	000 = No Scaling 001 = Reserved: Linear Scaling 010 = Rotational Scaling
3	Standard Scaling Type	0 = Preferred Scaling 1 = Parameter Scaling
4	Units for Linear Scaling	0 = Meters (m)
4	Units for Rotational	0 = Radian (rad)
5	Time Units	0 = Seconds (s)
6	Data Reference	0 = At the Motor Shaft
15-7	Reserved.	

* The rotational parameter scaling setting (IDN160 = 000Ah), can not be saved in the EEPROM (refer to IDN161, 162).

Data Length:	2 bytes	Non-Volatile:	Yes
Data Type:	Binary	Write Access:	CP2, CP3
Minimum:	0	Run-Up Check:	
Maximum:	000Ah	Cyclic Transfer:	
Default:	0	ASCII Param.:	ACCUNIT

3.115 IDN161 Acceleration Data Scaling Factor

Only for rotational parameter scaling (refer to IDN 160).

This parameter defines the scaling factor for all acceleration data in the amplifier.

$$LSBWeight = factor(IDN161) \bullet 10^{exponent(IDN162)} \left\{ \frac{rad}{s^2} \right\}$$

$$Preferred\ scaling(default) = 1 \bullet 10^{-3} \left\{ \frac{rad}{s^2} \right\}$$

Data Length:	2 bytes	Non-Volatile:	Fix
Data Type:	Unsigned decimal	Write Access:	Read-only
Minimum:		Run-Up Check:	
Maximum:		Cyclic Transfer:	
Default:	1	ASCII Param.:	

3.116 IDN162 Acceleration Data Scaling Exponent

Only for rotational parameter scaling (refer to IDN 160).

This parameter defines the scaling exponent for all acceleration data in the amplifier.

Data Length:	2 bytes	Non-Volatile:	No
Data Type:	Signed decimal	Write Access:	CP2, CP3
Minimum:	-3	Run-Up Check:	
Maximum:	0	Cyclic Transfer:	
Default:	-3	ASCII Param.:	

3.117 IDN169 Probe Control Parameter

The probe control parameter defines the input signal edge that will result in a position capture during the "Probing" procedure (IDN170). Each probe may be used to capture positions on both probe signal edges, but the probe edges must be separated by at least 0.5 milliseconds.

The table below describe the fixed settings if only digital input 2 is used for the latched function. For the other settings please refer also to IDNP3018.

Bit	Description	Setting
LSB 0	Probe 1 - Capture motor position on positive edge	0 = Inactive. 1 = Active.
1	Probe 1 - Capture motor position on negative edge	0 = Inactive. 1 = Active.
2	Probe 2 - Capture external position on positive edge	0 = Inactive. 1 = Active.
3	Probe 2 - Capture external position on negative edge	0 = Inactive. 1 = Active.
4 - 15	Reserved.	Set to 0.

Data Length:	2 bytes	Non-Volatile:	No
Data Type:	Binary	Write Access:	CP2, CP3, CP4
Minimum:	0	Run-Up Check:	
Maximum:	15	Cyclic Transfer:	
Default:	0	ASCII Param.:	

3.118 IDN170 Command: Probing

Probing is used to capture position data when a digital input changes. Each probe may trigger a position capture using both edges (rising and/or falling) of the digital input signal, as long as the edges are separated by at least 0.5 milliseconds. The "Probe Control Parameter" (IDN169) is used to configure the digital input edges that will trigger a position capture. Once the probe procedure is started by the master (set IDN170 to 3), it will continue indefinitely until either the master cancels the probing procedure or a probing error occurs.

The probing procedure will fail under the following conditions:

- 1) The "Homing" procedure (IDN148) is active.
- 2) A digital input has not been configured as a position capture input (IDNP3001).

During the activation of the probing procedure, the master arms the probe trigger by setting a "Probe Enable" signal (IDN405 or IDN406). After the probe trigger has been armed, the next rising and/or falling edge(s) (as specified in IDN169) on the probe inputs (IDN401 or IDN402) will latch the motor position and cause the corresponding "Probe Position Latch Status" (IDN179) bits to set.

Any further changes in the probe input are ignored until the master re-arms the probe trigger by clearing and setting the probe enable signal. The master may read captured positions through the "Probe 1+2 Positive Edge Value" (IDN130 and IDN132) and the "Probe 1+2 Negative Edge Value" (IDN131 and IDN133).

The amplifier supports two physical probe input that must be pre-configured through IDNP3001 and IDNP3000 or the amplifier setup software before starting the probe procedure.

Configuration will be selected with IDNP3018: Probe 1 = Input 2, Probe 2 = Input 1

It is possible to use only one physical probe input (digital input 2) with the two logical probes that are operated independently. Logical probe 1 then supports capturing the motor feedback while logical probe 2 supports capturing the external feedback. Accuracy see ASCII reference

Data Length:	2 bytes	Non-Volatile:	No
Data Type:	Binary	Write Access:	CP4
Minimum:		Run-Up Check:	
Maximum:		Cyclic Transfer:	
Default:	0	ASCII Param.:	

3.119 IDN179 Probe Position Latch Status

The probe status parameter indicates whether a position has been captured and latched within one of the "Probe Edge Value" IDNs (IDNs 130 through 133). IDN179 duplicates the information found in IDNs 409 through 412.

Bit	Description	Setting
LSB 0	Probe 1 - Position latched on positive edge (IDN130)	0 = No. 1 = Latched.
1	Probe 1 - Position latched on negative edge (IDN131)	0 = No. 1 = Latched.
2	Probe 2 - Position latched on positive edge (IDN132)	0 = No. 1 = Latched.
3	Probe 2 - Position latched on negative edge (IDN133)	0 = No. 1 = Latched.
4 - 15	Reserved.	Set to 0.

Data Length:	2 bytes	Non-Volatile:	No
Data Type:	Binary	Write Access:	Read-only
Minimum:		Run-Up Check:	
Maximum:		Cyclic Transfer:	
Default:	0	ASCII Param.:	

3.120 IDN181 Manufacturer Class 2 Diagnostic (MC2D)

Lists the manufacturer-defined warnings for the amplifier. If a warning condition is set or reset within IDN181, the manufacturer class 3 diagnostic bit (IDN12 bit 15) is set as well. When IDN181 is read via the service channel, the bit 15 of IDN12 will reset to 0.

Bit	Description	Setting
LSB 0	Voltage monitoring of SinCos feedback	0 = no warning 1 = warning
1-15	Reserved	

Data Length:	2 bytes	Non-Volatile:	No
Data Type:	Binary	Write Access:	Read-only
Minimum:		Run-Up Check:	
Maximum:		Cyclic Transfer:	
Default:	0	ASCII Param.:	

3.121 IDN182 Manufacturer Class 3 Diagnostic (MC3D)

Lists the manufacturer-defined status flags for the amplifier. If a status condition is set or reset within IDN182, the manufacturer class 3 diagnostic bit (IDN13 bit 15) is set as well. When IDN182 is read via the service channel, the bit 15 of IDN13 will reset to 0.

Bit	Description	Setting
LSB 0	Hardware enable	0 = not exist 1 = exist
1	warm boot (IDN128)	0 = not running 1 = still running
2	wake&shake not finished	
2 - 15	Reserved	

Data Length:	2 bytes	Non-Volatile:	No
Data Type:	Binary	Write Access:	Read-only
Minimum:		Run-Up Check:	
Maximum:		Cyclic Transfer:	
Default:	0	ASCII Param.:	

3.122 IDN185 Maximum Length of AT Configurable Data

Defines the maximum length, in bytes, of the AT's cyclic data field. The master may use this IDN to determine how many IDNs may be placed within the application telegram (refer to IDN15).

Data Length:	2 bytes	Non-Volatile:	Fix
Data Type:	Unsigned decimal	Write Access:	Read-only
Minimum:		Run-Up Check:	
Maximum:		Cyclic Transfer:	
Default:	24	ASCII Param.:	
Units:	Bytes	Version:	

3.123 IDN186 Maximum Length of MDT Configurable Data

Defines the maximum length, in bytes, of the MDT's cyclic data field. The master may use this IDN to determine how many IDNs may be placed within an application telegram (refer to IDN15).

Data Length:	2 bytes	Non-Volatile:	Fix
Data Type:	Unsigned decimal	Write Access:	Read-only
Minimum:		Run-Up Check:	
Maximum:		Cyclic Transfer:	
Default:	12	ASCII Param.:	
Units:	Bytes	Version:	

3.124 IDN187 List of AT Configurable Data IDNs

Lists all the IDNs that may be transferred as AT cyclic data. The master may use this IDN to determine the IDNs that may be placed within an amplifier telegram (refer to IDN15). The following IDNs may be assigned as AT cyclic data:

IDN	Description	IDN	Description
11	Class 1	P3012	Difference Probe Edge Value 1
40	Velocity Feedback Value	P3013	Difference Probe Edge Value 2
51	Position Feedback Value 1 (motor)	P3030	Digital Input 1 Status
53	Position Feedback Value 2 (external)	P3031	Digital Input 2 Status
59	Position Switch Flag Parameter	P3032	Digital Input 3 Status
80	Torque Setpoint Feedback	P3033	Digital Input 4 Status
84	Torque Feedback Value	P3034	Analog Input 1 Value
129	Manufacturer-Class 1	P3035	Analog Input 2 Value
130	Probe 1 Positive Edge Value	P3050	Analog Output 1 Value
131	Probe 1 Negative Edge Value	P3051	Analog Output 2 Value
132	Probe 2 Positive Edge Value	P3054	DPRVAR 1
133	Probe 2 Negative Edge Value		
189	Following Distance		
347	Velocity Control Deviation		

Data Length:	2 byte elements, variable length array	Non-Volatile:	Fix
Data Type:	IDN	Write Access:	Read-only
Minimum:		Run-Up Check:	
Maximum:		Cyclic Transfer:	
Default:		ASCII Param.:	

3.125 IDN188 List of MDT Configurable Data IDNs

Lists all the IDNs that may be transferred as MDT cyclic data. The master may use this IDN to determine the IDNs that may be placed within an application telegram (refer to IDN15). The following IDNs may be assigned as MDT cyclic data:

IDN	Description	IDN	Description
36	Velocity Command Value	P3036	Digital Output 1 Control/Status
47	Position Command Value	P3037	Digital Output 2 Control/Status
60	Position Switch Point 1	P3045	Integral Preload Current
62	Position Switch Point 3	P3050	Only /: Analog Output 1 Value
64	Position Switch Point 5	P3051	Only /: Analog Output 2 Value
66	Position Switch Point 7	P3053	DPRVAR 9
80	Torque Command Value		
81	Additive Torque Command Value		
92	Bipolar Torque Limit		

Data Length:	2 byte elements, variable length array	Non-Volatile:	Fix
Data Type:	IDN	Write Access:	Read-only
Minimum:		Run-Up Check:	
Maximum:		Cyclic Transfer:	
Default:		ASCII Param.:	
Units:		Version:	

3.126 IDN189 Following Distance

The distance between the position setpoint value and the appropriate position feedback value (1 or 2). The amplifier calculates this value by subtracting the position feedback value (1 or 2) from the position setpoint value.

Data Length:	4 bytes	Non-Volatile:	No
Data Type:	Signed decimal	Write Access:	Read-only
Minimum:		Run-Up Check:	
Maximum:		Cyclic Transfer:	AT
Default:		ASCII Param.:	PE
Units:	IDN76, 77, 78, 79, 123	Version:	

3.127 IDN192 IDN List of Back-up Operation Data

A list of all IDNs which are essential for amplifier operation. The master may use this list to back-up the amplifier parameters. If the amplifier is replaced, the IDNs within this list may be reloaded into the replacement amplifier using the order defined within IDN288 and IDN289 or direct the order of the list within this IDN.

Data Length:	2 byte elements, variable length array	Non-Volatile:	Fix
Data Type:	IDN	Write Access:	Read-only
Minimum:		Run-Up Check:	
Maximum:		Cyclic Transfer:	
Default:		ASCII Param.:	

3.128 IDN196 Motor Rated Current

The motor's rated current. If the motor rated current is less than that of the amplifier, the amplifier is automatically limited to the level of the motor rated current.

Data Length:	4 bytes	Non-Volatile:	Yes
Data Type:	Unsigned decimal	Write Access:	CP2, CP3
Minimum:	0.1 * IDN112	Run-Up Check:	
Maximum:	2 * IDN112	Cyclic Transfer:	
Default:	IDN112	ASCII Param.:	MICONT*1000
Units:	mA	Version:	

3.129 IDN197 Command; Set coordinate system

After activation of the command "Set coordinate system", the servo amplifier ignores the position command value and instead transfers the programmed "Initial coordinate value" into the amplifier-internal position command. For more information see SERCOS Specification.

3.130 IDN203 Amplifier Shutdown Temperature

When the amplifier temperature (heat sink temperature) exceed the value of the amplifier shutdown temperature, the amplifier sets the fault bit for amplifier over temperature fault in C1D (IDN11 bit 1).

Data Length:	2 bytes	Non-Volatile:	Yes
Data Type:	Unsigned decimal	Write Access:	CP2, CP3, CP4
Minimum:	200	Run-Up Check:	
Maximum:	850	Cyclic Transfer:	
Default:	800	ASCII Param.:	MAXTEMPH * 10
Units:	IDN208	Version:	

3.131 IDN205 Cooling Error Shutdown Temperature

When the temperature inside the amplifier housing exceed the value of the cooling error shutdown temperature, the amplifier sets the fault bit for cooling system fault in C1D (IDN11 bit 3).

Data Length:	2 bytes	Non-Volatile:	Yes
Data Type:	Unsigned decimal	Write Access:	CP2, CP3, CP4
Minimum:	100	Run-Up Check:	
Maximum:	800	Cyclic Transfer:	
Default:	700	ASCII Param.:	MAXTEMPE * 10
Units:	IDN208	Version:	

3.132 IDN208 Temperature Data Scaling Type

Defines the scaling options for all temperature data.

Bit		Description
0	Scaling Method	0 = 0.1°C
15-1		

Data Length:	2 bytes	Non-Volatile:	Fix
Data Type:	Binary	Write Access:	Read-only
Minimum:		Run-Up Check:	
Maximum:		Cyclic Transfer:	
Default:	0000h	ASCII Param.:	

3.133 IDN256 Multiplication Factor 1

The multiplication factor 1 defines the amplifier internal multiplication of an rotary encoder for the position feedback value 1 (IDN51).

Data Length:	4 Byte	Non-Volatile:	No
Data Type:	Unsigned decimal	Write Access:	CP2, CP3
Minimum:		Run-Up Check:	
Maximum:		Cyclic Transfer:	
Default:	256	ASCII Param.:	

3.134 IDN257 Multiplication Factor 2

The multiplication factor 2 defines the amplifier internal multiplication of an rotary encoder as an external feedback for the position feedback value 2 (IDN53). If the resolution of feedback 2 (IDN117) is not a result of 2x, the amplifier may use an additional scaling for IDN53.

If the master write IDN117 the amplifier calculate automatic the "Multiplication factor 2" (IDN257), for the external feedback, and an additional scaling factor if necessary, to scale the external feedback to the rotational position resolution set within IDN79 (refer to IDN53, 79 and 117). The amplifier also does the automatic calculation for position control with external feedback.

Data Length:	4 bytes	Non-Volatile:	Yes
Data Type:	Unsigned decimal	Write Access:	CP2, CP3
Minimum:		Run-Up Check:	
Maximum:		Cyclic Transfer:	
Default:	256	ASCII Param.:	EXTMUL

3.135 IDN262 Command: Load Default Values

Loads the manufacturer's default parameters into volatile memory. The parameters stored in non-volatile memory remain unchanged. The default parameters allow the amplifier to operate without problems, but the operation is not necessarily optimized.

This procedure will normally modify the amplifiers startup program, and the amplifier will re-compile the start-up program and perform a warmstart in the CP4 transition check, which may take up to 3 minutes. During the warmstart, the LED on the front panel of the amplifier will flash 3 dots. During the warmstart IDN182 Bit 1 is set, it will be cleared after the warmstart. Alternatively, the serial interface (setup software or terminal program) may be used to save all values and reset the amplifier before the CP4 transition check procedure is executed.

Data Length:	2 bytes	Non-Volatile:	No
Data Type:	Binary	Write Access:	CP2, CP3
Minimum:		Run-Up Check:	
Maximum:		Cyclic Transfer:	
Default:	0	ASCII Param.:	RSTVAR

3.136 IDN264 Command: Back-up Working Memory

This command saves all data essential for amplifier operation from the active memory to the non-volatile memory. IDN192 defines which data is essential for amplifier operation. Previously saved data is overwritten.

Data Length:	2 bytes	Non-Volatile:	No
Data Type:	Binary	Write Access:	CP2, CP3, CP4
Minimum:		Run-Up Check:	
Maximum:		Cyclic Transfer:	
Default:	0	ASCII Param.:	SAVE

3.137 IDN271 Amplifier ID

The master may store a unique amplifier identification number within this IDN. The identification number is saved to non-volatile memory when the "Back-up Working Memory" procedure (IDN264) is executed. The identification number is reset to zero when the "Load Default Values" procedure (IDN262) is executed.

Data Length:	4 bytes	Non-Volatile:	Yes
Data Type:	Unsigned decimal	Write Access:	CP2, CP3, CP4
Minimum:	0	Run-Up Check:	
Maximum:	32 767	Cyclic Transfer:	
Default:	0	ASCII Param.:	UID

3.138 IDN288 IDN List of Data Programmable in CP2

A list of all IDNs that may be written by the master in CP2. The IDNs are listed in the order in which the master should write them to avoid data dependency problems. Data dependency problems may arise, for example, when the range of one IDN depends upon an IDN that has not yet been written.

Data Length:	2 byte elements, variable length array	Non-Volatile:	Fix
Data Type:	IDN	Write Access:	Read-only
Minimum:		Run-Up Check:	
Maximum:		Cyclic Transfer:	
Default:		ASCII Param.:	

3.139 IDN289 IDN List of Data Programmable in CP3

A list of all IDNs that may be written by the master in CP3. The IDNs are listed in the order in which the master should write them to avoid data dependency problems. Data dependency problems may arise, for example, when the range of one IDN depends upon an IDN that has not yet been written.

Data Length:	2 byte elements, variable length array	Non-Volatile:	Fix
Data Type:	IDN	Write Access:	Read-only
Minimum:		Run-Up Check:	
Maximum:		Cyclic Transfer:	
Default:		ASCII Param.:	

3.140 IDN296 Velocity Feed-Forward Gain

Defines a multiplier for the velocity feedforward value that is generated from the position profile. Velocity feed-forward helps to reduce the velocity-dependent following error. Velocity feed-forward is added to the velocity setpoint when the active operational mode defined by IDN32 and/or IDN33 has bit 3 set and is in position control mode.

Data Length:	2 bytes	Non-Volatile:	Yes
Data Type:	Unsigned decimal	Write Access:	CP2, CP3, CP4
Minimum:	0	Run-Up Check:	
Maximum:	2000	Cyclic Transfer:	
Default:	1000	ASCII Param.:	GPFV
Units:	0.1%	Version:	

3.141 IDN298 Home Switch Distance

The distance of the home switch from the "optimal" location after homing. The "optimal" location is defined as half the distance between successive marker pulses (encoder) or null points (resolvers). The home switch distance may be used to ensure that the home switch is located correctly to avoid inconsistent homing. The home switch distance is not valid until homing has completed successfully (IDN403 is set).

Data Length:	4 bytes	Non-Volatile:	No
Data Type:	Signed decimal	Write Access:	Read-only
Minimum:		Run-Up Check:	
Maximum:		Cyclic Transfer:	
Default:	0	ASCII Param.:	
Units:	IDN76, 77, 78, 79, 123	Version:	

3.142 IDN301 Allocation of Real-time Control Bit 1

Assigns a control signal IDN to the real-time control bit 1 (RTC bit 1, MDT control word bit 6). Two RTC bits are defined within the MDT control word (bits 6 and 7) and may be updated every communication cycle by the master.

The following rules govern the assignment and use of RTC bit 1:

Only certain control signal IDNs of type binary may be assigned to the real time control allocation IDNs. The exception is IDN0, which indicates that the real time control bit is undefined.

The following IDNs may be assigned as RTC signals:

IDN	Description	IDN	Description
0	empty IDN	P3036	Digital Out 1
99	Command Clear Fault	P3037	Digital Out 2
405	Enable Latch 1 (IDNP3039=0)	P3038	Enable Latch 1+2 (IDNP3039=1)
406	Enable Latch 2 (IDNP3039=0)	P3057	Disable CAM 1+2
		P3058	Disable CAM 3+4

A new RTC bit assignment must be valid within the amplifier, before the service channel busy bit is reset. After the service channel busy bit from the amplifier is reset, the master can operate with the RTC bit 1 in the master control word.

Data Length:	2 bytes	Non-Volatile:	No
Data Type:	IDN	Write Access:	CP2, CP3, CP4
Minimum:		Run-Up Check:	
Maximum:		Cyclic Transfer:	
Default:	0	ASCII Param.:	

3.143 IDN303 Allocation of Real-time Control Bit 2

Assigns a control signal IDN to the real-time control bit 2 (RTC bit 2, MDT control word bit 7). Two RTC bits are defined within the MDT control word (bits 6 and 7) and may be updated every communication cycle by the master. For further information refer to IDN301.

Data Length:	2 bytes	Non-Volatile:	No
Data Type:	IDN	Write Access:	CP2, CP3, CP4
Minimum:		Run-Up Check:	
Maximum:		Cyclic Transfer:	
Default:	0	ASCII Param.:	

3.144 IDN304 Real-Time Status Bit 1

The value of the IDN assigned to RTS bit 1 (see IDN 305).

Data Length:	2 bytes	Non-Volatile:	No
Data Type:	Binary	Write Access:	Read-only
Minimum:		Run-Up Check:	
Maximum:		Cyclic Transfer:	
Default:		ASCII Param.:	

3.145 IDN305 Allocation of Real-time Status Bit 1

The IDN of a real-time status signal that appears in real-time status bit 1 (AT status word, bit 6). Two real time status bits are defined within the AT status word (bits 6 and 7) and are continuously updated by the amplifier during CP4.

Rules for the assignment and use of a real time status bit (i.e. writing IDN305/307):

Only status signal IDNs of type binary may be assigned to the real time status allocation IDNs. The exception is IDN0, which indicates that the real time status bit is undefined.

The following IDNs may be assigned as RTS signals:

IDN	Description	IDN	Description
0	Reserved	409	Message "Latch 1 Positive Edge Latched Status"
336	Message "In Position"	410	Message "Latch 1 Negative Edge Latched Status"
400	Home Switch	411	Message "Latch 2 Positive Edge Latched Status"
403	Position Feedback Status	412	Message "Latch 2 Negative Edge Latched Status"

The master should no longer evaluate a previous real-time status assignment after transmitting a write request for element 7 of a real-time status bit allocation IDN. The previously assigned real-time status bit will remain valid until the service channel busy bit is set.

The master should not start evaluating a new real-time status bit assignment until the service channel busy bit is reset by the amplifier.

Data Length:	2 bytes	Non-Volatile:	No
Data Type:	IDN	Write Access:	CP2, CP3, CP4
Minimum:		Run-Up Check:	
Maximum:		Cyclic Transfer:	
Default:	0	ASCII Param.:	

3.146 IDN306 Real-Time Status Bit 2

The value of the IDN assigned to RTS bit 2 (see IDN 307).

Data Length:	2 bytes	Non-Volatile:	No
Data Type:	Binary	Write Access:	Read-only
Minimum:		Run-Up Check:	
Maximum:		Cyclic Transfer:	
Default:		ASCII Param.:	

3.147 IDN307 Allocation of Real-time Status Bit 2

The IDN of a real-time status signal that appears in real-time status bit 2 (AT status word, bit 7).

Two real-time status bits are defined within the AT status word (bits 6 and 7) and are continuously updated by the amplifier during CP4.

For further information, refer to IDN305.

Data Length:	2 bytes	Non-Volatile:	No
Data Type:	IDN	Write Access:	CP2, CP3, CP4
Minimum:		Run-Up Check:	
Maximum:		Cyclic Transfer:	
Default:	0	ASCII Param.:	

3.148 IDN312 Temperature Warning Motor Status

This warning signal IDN is set (bit 0 = 1) when the motor temperature exceeds the threshold set in IDN201.

Data Length:	2 bytes	Non-Volatile:	No
Data Type:	Binary	Write Access:	Read-only
Minimum:		Run-Up Check:	
Maximum:		Cyclic Transfer:	
Default:		ASCII Param.:	

3.149 IDN323 Status “Target position outside of travel range”

A warning signal IDN that is set (Bit 0 = 1) when the target position is outside of the travel range. This IDN will set if the HW- or SW-Limit Switch is active. The amplifier show this by flashing the warning “n10” or “n07” for outside of positive range or “n11” or “n06” outside of negative range. IDN323 duplicates the C2D “Target position outside of travel range” warning bit (IDN12, bit 13).

Data Length:	2 bytes	Non-Volatile:	No
Data Type:	Binary	Write Access:	Read-only
Minimum:		Run-Up Check:	
Maximum:		Cyclic Transfer:	
Default:		ASCII Param.:	see DRVSTAT

3.150 IDN336 Status “In Position”

A status signal IDN that is set when the difference between the position setpoint value and the position feedback value falls within the range defined by the “Position Window” (IDN57). IDN336 duplicates the C3D “In Position” status bit (IDN13, bit 6) and may be assigned to a RTS bit (AT status word bit 6 or 7) through IDN305 or IDN307.

Data Length:	2 bytes	Non-Volatile:	No
Data Type:	Binary	Write Access:	Read-only
Minimum:		Run-Up Check:	
Maximum:		Cyclic Transfer:	RTS
Default:		ASCII Param.:	see INPOS, DRVSTAT

3.151 IDN347 Velocity Control Deviation

The master retrieves the amplifier’s current velocity control deviation via this IDN.

Data Length:	2 bytes	Non-Volatile:	No
Data Type:	Signed decimal	Write Access:	Read-only
Minimum:		Run-Up Check:	
Maximum:		Cyclic Transfer:	
Default:		ASCII Param.:	
Units:	IDN 44, 45, 46	Version:	

3.152 IDN348 Gain for Acceleration Feed Forward

If the acceleration feed forward is activated via P-IDN 3052, influences the feed forward gain.

Data Length:	2 Byte	Non-Volatile:	Yes
Data Type:	2 bytes	Write Access:	CP2, CP3, CP4
Minimum:	Unsigned decimal	Run-Up Check:	
Maximum:	1000	Cyclic Transfer:	
Default:	1	ASCII Param.:	GPFFT

3.153 IDN376 Supported Baud Rate

Bit	Description	Bit	Description
0	2 Mbit/s	2	8 Mbit/s
1	4 Mbit/s	3	16 Mbit/s

Data Length:	2 bytes	Non-Volatile:	No
Data Type:	Unsigned decimal	Write Access:	Read-only
Minimum:		Run-Up Check:	
Maximum:		Cyclic Transfer:	
Default:	1	ASCII Param.:	

3.154 IDN380 DC Bus Link Voltage

The master retrieves the amplifier's DC bus link voltage through this IDN.

Data Length:	2 bytes	Non-Volatile:	No
Data Type:	Unsigned decimal	Write Access:	Read-only
Minimum:	0	Run-Up Check:	
Maximum:	900	Cyclic Transfer:	
Default:		ASCII Param.:	VBUS
Units:	Volt	Version:	

3.155 IDN384 Amplifier Temperature

The master retrieves the amplifier's heat sink temperature from the amplifier through this IDN.

Data Length:	2 bytes	Non-Volatile:	No
Data Type:	Unsigned decimal	Write Access:	Read-only
Minimum:		Run-Up Check:	
Maximum:		Cyclic Transfer:	
Default:		ASCII Param.:	TEMPH * 10
Units:	IDN208	Version:	

3.156 IDN392 Velocity Feedback Filter Time Constant

The velocity feedback is passed through a first order low pass filter before being applied to the velocity loop. The filter is useful for improving the step response and operational smoothness, particularly for very small, highly dynamic motors. If the filter's time constant is too low, then the motor may run roughly. If the filter's time constant is too high, then the motor's response may be soft and unstable. The filter's time constant may be adjusted in intervals of 100 μ s.

Data Length:	2 bytes	Non-Volatile:	Yes
Data Type:	Unsigned decimal	Write Access:	CP2, CP3, CP4
Minimum:	0	Run-Up Check:	
Maximum:	65500	Cyclic Transfer:	
Default:	400	ASCII Param.:	GVFBT
Units:	μ s	Version:	

3.157 IDN400 Home Switch Status

Contains the state of the home switch. The digital input used as home switch input is assigned through the use of digital input mode IDNs (IDNP3000, IDNP3001, IDNP3002 or IDNP3003). IDN400 is useful for assigning the home switch signal to a RTS bit.

Data Length:	2 bytes	Non-Volatile:	No
Data Type:	Binary	Write Access:	Read-only
Minimum:		Run-Up Check:	
Maximum:		Cyclic Transfer:	RTS
Default:		ASCII Param.:	IN1, IN2, IN3, IN4

3.158 IDN401 Probe 1 Status

Contains the state of the probe 1 input. The digital input used as a probe is assigned through the use of IDNP3001. The amplifier updates the probe 1 IDN only when the probing procedure (IDN170) is active and the probe 1 enable (IDN405) is set.

Data Length:	2 bytes	Non-Volatile:	No
Data Type:	Binary	Write Access:	Read-only
Minimum:	0	Run-Up Check:	
Maximum:	1	Cyclic Transfer:	
Default:	0	ASCII Param.:	IN1

3.159 IDN402 Probe 2 Status

Contains the state of the probe 2 input. The digital input used as a probe is assigned through the use of IDNP3001. The amplifier updates the probe 2 IDN only when the probing procedure (IDN170) is active and the probe 2 enable (IDN406) is set.

Data Length:	2 bytes	Non-Volatile:	No
Data Type:	Binary	Write Access:	Read-only
Minimum:	0	Run-Up Check:	
Maximum:	1	Cyclic Transfer:	
Default:	0	ASCII Param.:	IN2

3.160 IDN403 Position Feedback Value Status

The position feedback value status flag is set by the amplifier during homing when the position feedback is referenced to the machine zero point. The status flag is reset after power-up, and when the "Amplifier-Controlled Homing" procedure (IDN148) is started. IDN403 may be assigned to a RTS bit (AT status word bit 6 or 7) through IDN305 or IDN307.

Data Length:	2 bytes	Non-Volatile:	No
Data Type:	Binary	Write Access:	Read-only
Minimum:	0	Run-Up Check:	
Maximum:	1	Cyclic Transfer:	
Default:	0	ASCII Param.:	

3.161 IDN405 Probe 1 Enable

Used to arm the position capture mechanism so that the next valid probing signal edge captures the current position into IDN130 or 131. IDN405 may be assigned to a RTC bit (MDT control word bit 6 or 7) through IDN301 or IDN303. This IDN is write-protected while it is assigned to a RTC bit and could only reset to 0 via the System Communications. Refer to IDN170 and IDNP3038 for more information.

Data Length:	2 bytes	Non-Volatile:	No
Data Type:	Binary	Write Access:	CP2, CP3, CP4
Minimum:	0	Run-Up Check:	
Maximum:	1	Cyclic Transfer:	
Default:		ASCII Param.:	

3.162 IDN406 Probe 2 Enable

Used to arm the position capture mechanism so that the next valid probing signal edge captures the current position into IDN132 or 133. IDN406 may be assigned to a RTC bit (MDT control word bit 6 or 7) through IDN301 or IDN303. This IDN is write-protected while it is assigned to a RTC bit and could only reset to 0 via the System Communications. Refer to IDN170 and IDNP3038 for more information.

Data Length:	2 bytes	Non-Volatile:	No
Data Type:	Binary	Write Access:	CP2, CP3, CP4
Minimum:	0	Run-Up Check:	
Maximum:	1	Cyclic Transfer:	
Default:		ASCII Param.:	

3.163 IDN409 Probe 1 Positive Edge Latched Status

Indicates whether captured position data has been latched within IDN130 after the rising edge of the probe 1 input signal (IDN401). Position data can only be latched on the positive edge of probe 1 if the "Probing" procedure (IDN170) is active and the "Probe Control Parameter" (IDN169) has been configured to use the positive edge of probe 1.

Additionally, probe 1 must be armed by setting the "Probe 1 Enable" (IDN405). After arming probe 1, the next probe 1 rising edge will capture the current position and the "probe 1 positive edge latched status" will set when the captured data is available in IDN130. Once the latched status has been set, no more position captures will occur on the rising edges of the probe 1 input until the master re-arms probe 1 by clearing and setting the probe 1 enable. Clearing the probe 1 enable signal will reset the latch status.

IDN409 duplicates information found in the probe status (IDN179, bit 0). IDN409 may be assigned to a RTS bit (AT status word bit 6 or 7) through IDN305 or IDN307.

Data Length:	2 bytes	Non-Volatile:	No
Data Type:	Binary	Write Access:	Read-only
Minimum:		Run-Up Check:	
Maximum:		Cyclic Transfer:	
Default:	0	ASCII Param.:	

3.164 IDN410 Probe 1 Negative Edge Latched Status

Indicates whether captured position data has been latched within IDN131 after the falling edge of the probe 1 input signal (IDN401). Position data can only be latched on the negative edge of probe 1 if the probing procedure (IDN170) is active and the "Probe Control Parameter" (IDN169) has been configured to use the negative edge of probe 1.

Additionally, probe 1 must be armed by setting the "Probe 1 Enable" (IDN405). After arming probe 1, the next probe 1 falling edge will capture the current position and the "probe 1 negative edge latched status" will set when the captured data is available in IDN131. Once the latched status has been set, no more position captures will occur on the falling edges of the probe 1 input until the master re-arms probe 1 by clearing and setting the probe 1 enable. Clearing the probe 1 enable signal will reset the latch status.

IDN410 duplicates information found in the probe status (IDN179, bit 1). IDN410 may be assigned to a RTS bit (AT status word bit 6 or 7) through IDN305 or IDN307.

Data Length:	2 bytes	Non-Volatile:	No
Data Type:	Binary	Write Access:	Read-only
Minimum:		Run-Up Check:	
Maximum:		Cyclic Transfer:	
Default:	0	ASCII Param.:	

3.165 IDN411 Probe 2 Positive Edge Latched Status

Indicates whether captured position data has been latched within IDN132 after the rising edge of the probe 2 input signal (IDN402). Position data can only be latched on the positive edge of probe 2 if the "Probing" procedure (IDN170) is active and the "Probe Control Parameter" (IDN169) has been configured to use the positive edge of probe 2.

Additionally, probe 2 must be armed by setting the "Probe 2 Enable" (IDN406). After arming probe 2, the next probe 2 rising edge will capture the current position and the "probe 2 positive edge latched status" will set when the captured data is available in IDN132. Once the latched status has been set, no more position captures will occur on the rising edges of the probe 2 input until the master re-arms probe 2 by clearing and setting the probe 2 enable. Clearing the probe 2 enable signal will reset the latch status.

IDN411 duplicates information found in the probe status (IDN179, bit 2). IDN411 may be assigned to a RTS bit (AT status word bit 6 or 7) through IDN305 or IDN307.

Data Length:	2 bytes	Non-Volatile:	No
Data Type:	Binary	Write Access:	Read-only
Minimum:		Run-Up Check:	
Maximum:		Cyclic Transfer:	
Default:	0	ASCII Param.:	

3.166 IDN412 Probe 2 Negative Edge Latched Status

Indicates whether captured position data has been latched within IDN133 after the falling edge of the probe 2 input signal (IDN402). Position data can only be latched on the negative edge of probe 2 if the probing procedure (IDN170) is active and the "Probe Control Parameter" (IDN169) has been configured to use the negative edge of probe 2.

Additionally, probe 2 must be armed by setting the "Probe 2 Enable" (IDN406). After arming probe 2, the next probe 2 falling edge will capture the current position and the "probe 2 negative edge latched status" will set when the captured data is available in IDN133. Once the latched status has been set, no more position captures will occur on the falling edges of the probe 2 input until the master re-arms probe 2 by clearing and setting the probe 2 enable. Clearing the probe 2 enable signal will reset the latch status.

IDN412 duplicates information found in the probe status (IDN179, bit 3). IDN412 may be assigned to a RTS bit (AT status word bit 6 or 7) through IDN305 or IDN307.

Data Length:	2 bytes	Non-Volatile:	No
Data Type:	Binary	Write Access:	Read-only
Minimum:		Run-Up Check:	
Maximum:		Cyclic Transfer:	
Default:	0	ASCII Param.:	

3.167 IDN447 Command: Sete absolute position

After activation of the "Set absolute position procedure command" the servo amplifier ignores the position command value. The difference between the position feedback and the Reference Distance is calculated and stored. Refer to the SERCOS specification for more information.

3.168 IDNP3000..3003 (35 768..35 771) Digital Input 1..4 Configuration

Sets the functionality of digital inputs 1 through 4. The digital inputs may be read directly through IDNs P3030 through P3033. The configurable functions depend on the used amplifier and are described in the ASCII Object Reference.

A new input mode will not be active until the parameter set is saved to non-volatile memory and a coldstart or warmstart (IDN128) procedure is initiated.

Data Length:	2 bytes	Non-Volatile:	Yes
Data Type:	Unsigned decimal	Write Access:	CP2, CP3
Minimum:		Run-Up Check:	
Maximum:		Cyclic Transfer:	
Default:		ASCII Param.:	InxMODE (x = 1, 2, 3, 4).

3.169 IDNP3004 (35 772) Position Switch Configuration

Extends the functionality of the "Position Switch Points" (IDNs 60 through 63). A new position switch configuration will not be active until the parameter set is saved to non-volatile memory and a coldstart or warmstart (IDN128) procedure is initiated.

The software limit switches are active when linear scaling without modulo is selected for IDN76.

Bit	Description	Setting
LSB 0	Software Limit Switch 1 active (smaller position value)	0 = Limit switched off 1 = Limit switched active
1	Software Limit Switch 2 active (larger position value).	0 = Limit switched off 1 = Limit switched active

Data Length:	2 bytes	Non-Volatile:	Yes
Data Type:	Binary	Write Access:	CP2, CP3
Minimum:	0	Run-Up Check:	
Maximum:	65535	Cyclic Transfer:	
Default:	0	ASCII Param.:	SWCNFG

3.170 IDNP3005/3006 (35 773 / 35 774) Digital Output 1..2 Configuration

Sets the functionality of the digital outputs. The digital outputs may be read through IDNP3036 and IDNP3037.

The configurable functions depend on the used amplifier and are described in the ASCII Object Reference.

A new digital output mode will not be active until the parameter set is saved to non-volatile memory and a coldstart or warmstart (IDN128) procedure is initiated.

Data Length:	2 bytes	Non-Volatile:	Yes
Data Type:	Unsigned decimal	Write Access:	CP2, CP3
Minimum:		Run-Up Check:	
Maximum:		Cyclic Transfer:	
Default:		ASCII Param.:	O1MODE, O2MODE

3.171 IDNP3007/3008 (35 775 / 35 776) Digital Output Trigger

Sets a help or trigger value to the functionality of the digital outputs (refer to P3005 and P3006).

Data Length:	4 bytes	Non-Volatile:	Yes
Data Type:	Signed decimal	Write Access:	CP2, CP3, CP4
Minimum:		Run-Up Check:	
Maximum:		Cyclic Transfer:	
Default:	0	ASCII Param.:	OxTRIG

3.172 IDNP3009 (35 777) Release Motor Brake

If the drive is not enabled and EXTBRAKE is set to 1, the brake can be released.

If the brake is released by the powerstage it is not possible to disable the brake by this IDN

Data Length:	2 bytes	Non-Volatile:	No
Data Type:	Signed decimal	Write Access:	CP2, CP3, CP4
Minimum:	0	Run-Up Check:	
Maximum:	1	Cyclic Transfer:	
Default:	0	ASCII Param.:	

3.173 IDNP3010 (35 778) Feedback Type

Sets the motor feedback type. A new feedback type will not be active until the parameter set is saved to non-volatile memory and a coldstart or warmstart (IDN128) procedure is initiated.

Mode	Function
0	Resolver
1	-
2	HIPERFACE® with Zero Pulse
3	Resolver, EnDAT or Hiperface
4	EnDat (Heidenhain)
5	-
6	Sine-/Cosine-Encoder EEPROM
7	Sine-/Cosine-Encoder + W&S 5V
8	RS422 + W&S
9	RS422 (MPHASE out of EEPROM)
10	Without Feedback Device (sensorless)
11	Sine-/Cosine-Encoder + Hall
12	RS422 feedback device with hall's
13	-
14	-
15	-
16	Start with type 0, then switch to type 7
17	-
18	-
19	-

Data Length:	2 bytes	Non-Volatile:	Yes
Data Type:	Unsigned decimal	Write Access:	CP2, CP3
Minimum:		Run-Up Check:	
Maximum:		Cyclic Transfer:	
Default:		ASCII Param.:	FBTYP

3.174 IDNP3011 (35 779) Encoder Emulation Configuration

Sets the signaling format for the encoder emulation on connector X5 (S400: X4). A new emulation mode will not become active until the parameter set is saved to non-volatile memory and a coldstart or warmstart (IDN128) procedure is initiated.

Mode	Function	Comments
0	Input	The interface is used as an input.
1	AqB (ROD)	Incremental encoder emulation. Incremental encoder compatible pulses (max. 250 kHz) are transmitted as two signals (A and B) with a 90° electrical phase difference (quadrature). A zero marker pulse is also transmitted. If an encoder with a commutation track is used, then the output of the zero marker pulse is inhibited until the zero pulse from the encoder has been evaluated.
2	SSI	Synchron serial interface (SSI) for absolute encoder emulation. The standard SSI absolute encoder format transmits 24 bits. The upper 12 bits are fixed to zero and the lower 12 bits contain position information. For 'N' pole resolver feedback systems, the transmitted position refers to the position within 2/N turns of the motor. If an encoder with a commutation track is used as feedback, then the upper 12 bits are set to 1 (invalid data) until homing is performed.
3	ROD-Emulation	Incremental encoder emulation (AqB) with interpolation

Data Length:	2 bytes	Non-Volatile:	Yes
Data Type:	Unsigned decimal	Write Access:	CP2, CP3
Minimum:	0	Run-Up Check:	
Maximum:	3	Cyclic Transfer:	
Default:	1	ASCII Param.:	ENCMODE

3.175 IDNP3012 (35780) Difference Probe Edge Value 1

The amount of the difference between two latched values of probe 1 is stored here. Which latched values are used to calculate the edge difference is defined with the IDNP3014 "Probe Difference control parameter". The value will be directly computed when a new value is latched (refer to IDNP3014).

Data Length:	4 bytes	Non-Volatile:	No
Data Type:	Signed decimal	Write Access:	Read-only
Minimum:	0	Run-Up Check:	
Maximum:	$2^{31} - 1$	Cyclic Transfer:	AT
Default:	0	ASCII Param.:	
Units:	IDN76, 77, 78, 79, 123	Version:	

3.176 IDNP3013 (35781) Difference Probe Edge Value 2

The amount of the difference between two latched values of probe 2 is stored here. Which latched values are used to calculate the edge difference is defined with the IDNP3014 "Probe Difference control parameter". The value will be directly computed when a new value is latched (refer to IDNP3014).

Data Length:	4 bytes	Non-Volatile:	No
Data Type:	Signed decimal	Write Access:	Read-only
Minimum:	0	Run-Up Check:	
Maximum:	$2^{31} - 1$	Cyclic Transfer:	AT
Default:	0	ASCII Param.:	
Units:	IDN76, 79	Version:	

3.177 IDNP3014 (35782) Probe Difference Control Parameter

This parameter is used to define the calculation rule of the difference probe edge function, for IDN's P3012 and P3013.

Value	Description
0	Difference probe edge function is off
1	Compute distance between one positive edge and one negative edge
2	Compute distance between one negative edge and one positive edge
3	Compute distance between two positive edges
4	Compute distance between two negative edges
5	Compute distance between the first positive and negative edge
6	Compute distance between the first negative and positive edge

In order for this function to work correctly, the following conditions must be considered:

- The probe command must be activated (IDN170 = 3).
- Probe 1 must be enabled by a positive edge for IDN405 (also for feedback type 2 and probe 2) or a positive edge for IDNP 3038.
- Both edges for Probe 1 must be activated (IDN169 Bit 0 and 1 = 1).
- The conditions for the times between the edges must take account of the rules for each application example.

The application examples explain the calculation rule for the IDNP3012 "Difference Probe Edge Value 1", but the rules are also valid for IDNP3013 "Difference Probe Edge Value 2".

Application Example : IDNP3014 = 1

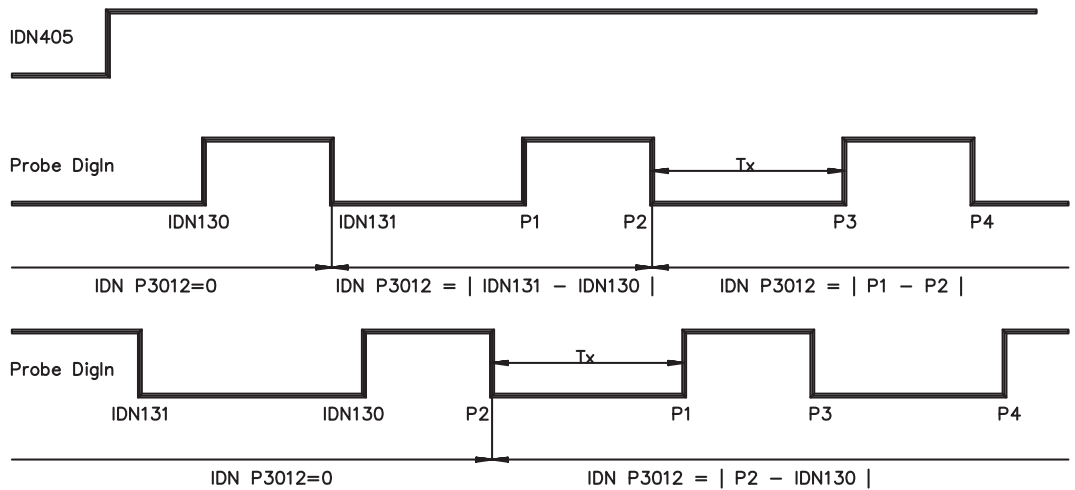

Condition for T_x : $T_x \geq T_{Scyc} + 250 \mu s$

Application Example : IDNP3014 = 2

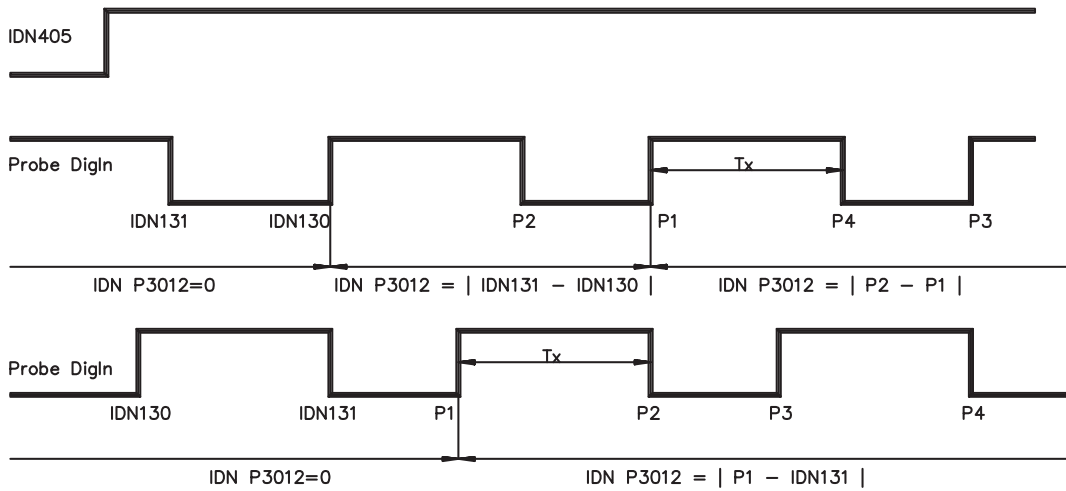

Condition for Tx : $T_x \geq T_{Scyc} + 250 \mu s$

Application Example : IDNP3014 = 3

IDNP3012 = | IDN130 - P1 | after the measuring time for P1 in all drawings in the application example 1 & 2.

The condition for the time between P1 and P3 : $T_x \geq T_{Scyc} + 250 \mu s$

Application Example : IDNP3014 = 4

IDNP3012 = | IDN131 - P2 | after the measuring time for P2 in all drawings in the application example 1 & 2.

The condition for the time between P2 and P4 : $T_x \geq T_{Scyc} + 250 \mu s$

Application Example : IDNP3014 = 5

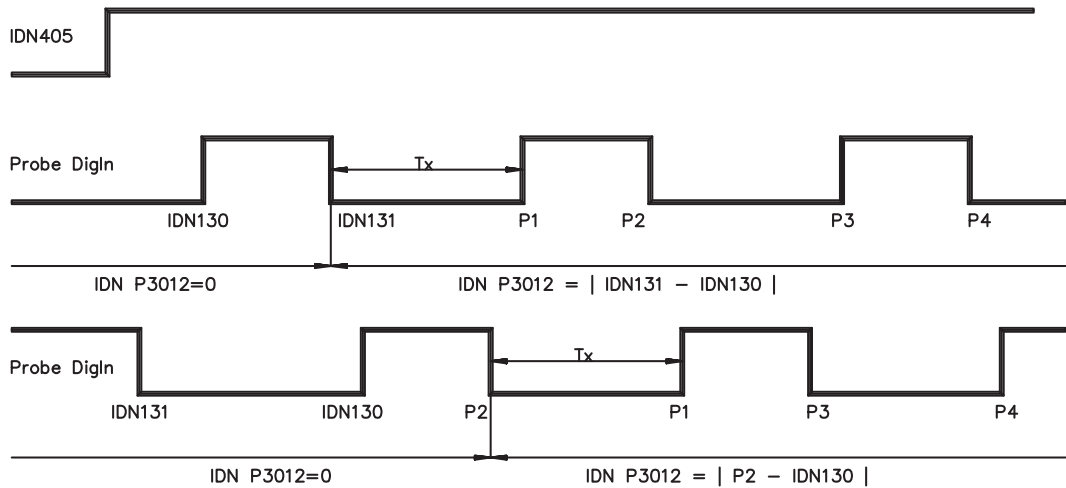

Condition for Tx : $T_x \geq T_{Scyc} + 250 \mu s$

Application Example : IDNP3014 = 6

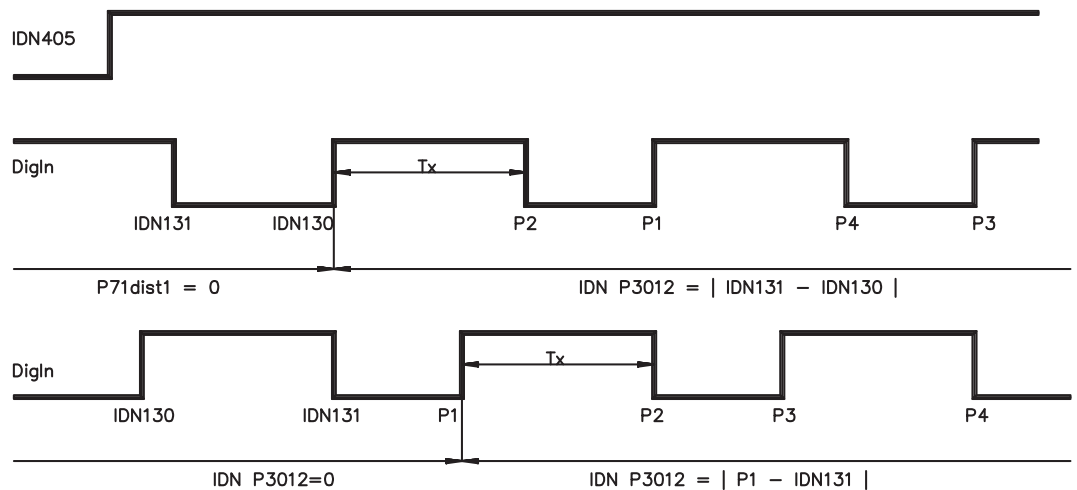

Condition for T_x : $T_x \geq T_{Scyc} + 250 \mu s$

Data Length:	2 bytes	Non-Volatile:	No
Data Type:	Unsigned decimal	Write Access:	CP2, CP3, CP4
Minimum:	0	Run-Up Check:	
Maximum:	6	Cyclic Transfer:	
Default:	0	ASCII Param.:	

3.178

IDNP3015 (35 783) Hardware Limit Switch Consequence

This parameter defines the consequence of the Hardware Limit Switch, if the corresponding digital inputs (IDNP3002 and/or P3003) are set to the function "hardware limit switches".

If the IDNP3015 is set to 0, a warning occurs.

If the IDNP3015 is set to 1, a fault occurs, the amplifier ramps down and sets fault bit 15 in IDN11 and in IDN129 the bit 2.

After the reset class 1 diagnostic command (IDN99) the amplifier can enable again and move back into the valid range. During the procedure amplifier-controlled homing (IDN148), the hardware limit switch can be used in the normal way (refer to IDNP3027).

Data Length:	2 bytes	Non-Volatile:	Yes
Data Type:	Unsigned decimal	Write Access:	CP2, CP3, CP4
Minimum:	0	Run-Up Check:	
Maximum:	1	Cyclic Transfer:	
Default:	0	ASCII Param.:	SERCSET (Bit 0)

3.179

IDNP3016 (35 784) Reset Command Consequence: prevent cold start

This parameter defines the consequence of the reset class 1 diagnostic command (IDN99), for faults which require a coldstart. If this IDN is set, faults which require a coldstart will not clear. The reset command will abort with the service channel message "Command execution not possible" (refer to IDN11, 99 and 129).

Data Length:	2 bytes	Non-Volatile:	Yes
Data Type:	Unsigned decimal	Write Access:	CP2, CP3, CP4
Minimum:	0	Run-Up Check:	
Maximum:	1	Cyclic Transfer:	
Default:	0	ASCII Param.:	SERCSET (Bit 1)

3.180 IDNP3017 (35 785) Position Feedback Type

The parameter EXTPOS specifies the feedback source for the internal position controller. For the majority of applications, position information for commutation and position control can be used from a single source. This source is specified with parameter FBTYPE and can be a resolver, EnDat/Hiperface feedback or other feedback. In certain applications it may be useful to use position information for commutation and position control from a different feedback source. In these applications, parameter FBTYPE defines the source for commutation.

Configuration variable EXTPOS is used to define the source for position controller position information (commutation unit FBTYPE or external feedback GEARMODE). The type of position control (P/PI) can also be specified.

For detailed information, please refer to the ASCII reference document (EXTPOS).

Data Length:	2 bytes	Non-Volatile:	Yes
Data Type:	Unsigned decimal	Write Access:	CP2, CP3
Minimum:	0	Run-Up Check:	
Maximum:	4	Cyclic Transfer:	
Default:	0	ASCII Param.:	EXTPOS

3.181 IDNP3018 (35 786) Configuration of the Position latch

Configuration variable EXTLATCH defines the source of the position information when using the latch functions.

When setting IN1MODE = 26 or IN2MODE=26, digital input 1 or 2 can be used as a latch input. A rising/falling edge at this input saves the internal position in a latch register.

The source of the position information depends on the settings for variables IN1MODE, IN2MODE and EXTLATCH.

If both inputs (input 1 and input 2) have been configured for the latch function, variable EXTLATCH can be used to define the position sources for the individual latch inputs: EXTLATCH=1 -> INPUT2 is used as latch input, EXTLATCH=2 both inputs are used.

If only digital input 2 has been configured for the latch function (IN2MODE = 26), variable EXTLATCH has no function. In the event of an edge at digital input 2, both the position of the motor feedback (resolver/EnDat/Hiperface) (Probe 1) and the external feedback (Probe 2) are saved.

Data Length:	2 bytes	Non-Volatile:	Yes
Data Type:	Unsigned decimal	Write Access:	CP2, CP3
Minimum:	0	Run-Up Check:	
Maximum:	2	Cyclic Transfer:	
Default:	0	ASCII Param.:	EXTLATCH

3.182 IDNP3019 (35 787) Selection of the FPGA Program

Command FPGA specifies which FPGA program is to be loaded in the initialization phase.

FPGA = 0 Program with over-travel counter in encoder simulation X5 (for S400 X4).

FPGA = 1 Program with up/down counter (this program enables a sincos motor to be used as a slave in a master/slave application).

FPGA = 3 Program, which in newer CAN versions enables the synchronisation of the connected amplifiers (FW >= 4.56).

FPGA = 4 Replacement for the standard program, when this is set, additional bits are output for SSI output 3. 12 bit revolutions and 15 bits per revolution.

Data Length:	2 bytes	Non-Volatile:	Yes
Data Type:	Unsigned decimal	Write Access:	CP2, CP3
Minimum:	0	Run-Up Check:	
Maximum:	4	Cyclic Transfer:	
Default:	0	ASCII Param.:	FPGA

3.183 IDNP3020 (35 788) System Rated Current

Allows setting the rated output current of the amplifier/motor system.

Data Length:	4 bytes	Non-Volatile:	yes
Data Type:	Unsigned decimal	Write Access:	CP2, CP3
Minimum:	10% of IDN112.	Run-Up Check:	
Maximum:	Minimum of IDN111 and IDN112.	Cyclic Transfer:	
Default:	50% of the minimum of IDN112.	ASCII Param.:	ICONT
Units:	mA	Version:	

3.184 IDNP3021 (35 789) Over Speed

The maximum motor speed threshold. If the maximum motor speed is exceeded, then an overspeed fault (IDN129, bit 9) occurs.

Data Length:	4 bytes	Non-Volatile:	Yes
Data Type:	Unsigned decimal	Write Access:	CP2, CP3, CP4
Minimum:	0	Run-Up Check:	
Maximum:	1.2 * IDN113	Cyclic Transfer:	
Default:	36 000 000	ASCII Param.:	similar to VOSPD
Units:	0.0001 RPM	Version:	

3.185 IDNP3022 (35 790) Emergency Stop Rate

The amplifier uses the emergency stop rate during an active disable (MDT control bit 15, a fault or a limit value excess).

Data Length:	4 bytes	Non-Volatile:	Yes
Data Type:	Signed decimal	Write Access:	CP2, CP3, CP4
Minimum:	1	Run-Up Check:	
Maximum:	32767	Cyclic Transfer:	
Default:	10	ASCII Param.:	DECSTOP
Units:	IDN160, 161, 162	Version:	

3.186 IDNP3023 (35 791) 2nd Filter Time Constant Velocity Control

Filter time constants after the velocity control (BQMODE1). The part that is to be filtered can be modified by GVFLT.

Data Length:	2 bytes	Non-Volatile:	Yes
Data Type:	Unsigned decimal	Write Access:	CP2, CP3, CP4
Minimum:	0	Run-Up Check:	
Maximum:	30	Cyclic Transfer:	
Default:	1	ASCII Param.:	GVT2

3.187 IDNP3024 (35 792) Proportional Gain Velocity Control

Velocity control gain when using the PI position controller. This parameter is only used with the PI position controller (EXTPOS = 0.2).

Data Length:	2 bytes	Non-Volatile:	Yes
Data Type:	Unsigned decimal	Write Access:	CP2, CP3, CP4
Minimum:	0.1	Run-Up Check:	
Maximum:	60	Cyclic Transfer:	
Default:	3	ASCII Param.:	GPV

3.188 IDNP3025 (35 793) Command DIR

DIR is a 16-bit variable in which the individual bits specify the counting direction for different feedback devices.

DIR = 0 negative counting direction - positive speed, velocity and current specifications turn the motor shaft anti-clockwise.

DIR = 1 positive counting direction - positive speed, velocity and current specifications turn the motor shaft clockwise. Bit = 1 positive direction.

Data Length:	2 bytes	Non-Volatile:	Yes
Data Type:	Unsigned decimal	Write Access:	read-only
Minimum:	0	Run-Up Check:	
Maximum:	1	Cyclic Transfer:	
Default:	1	ASCII Param.:	

3.189 IDNP3026 (35 794) Non-Volatile Memory Data Checksum

A checksum of the data stored within non-volatile memory. The checksum is updated after a "Back-up Working Memory" procedure (IDN264) has been executed successfully. The checksum is calculated with a CRC algorithm.

Data Length:	2 bytes	Non-Volatile:	Fix
Data Type:	Unsigned decimal	Write Access:	Read-only
Minimum:		Run-Up Check:	
Maximum:		Cyclic Transfer:	
Default:		ASCII Param.:	

3.190 IDNP3027 (35 795) Manufacturer Homing Modes

Selection of manufacturer-defined homing modes.

If command IDN148 is active, then IDN147 is write protected.

This IDN contains the saved serial command NREF after reset. Write this P IDN or write IDN147 through the service channel to change the homing mode used for the amplifier-controlled homing (IDN148). After or while homing with SERCOS the parameter NREF contains the value of this IDN. A following SAVE command can save this value permanently.

IDNP 3027 is set using ASCII command NREF.

Mode	Function
0	Set reference point to the actual position
1	Traverse to the reference switch with zero-mark recognition
2	Move to hardware limit-switch, with zero-mark recognition
3	Move to reference switch, without zero-mark recognition
4	Move to hardware limit-switch, without zero-mark recognition
5	Move to the next zero-mark of the feedback unit
6	Set reference at actual position, without losing target position
7	Move to mechanical stop with zero-mark recognition
8	Move to absolute SSI-position
9	Move to mechanical stop without zero-mark recognition

INFO

Hardware limit switches must be present and connected. The appropriate limit switch functions must be switched on, i.e. digital input 3 must be PSTOP (IDNP3002, mode2) and/or digital input 4 must be NSTOP (IDNP3003, mode 3).

Mechanical Stop Homing (mode 7) without hardware limit switch

This homing mode uses the mechanical stop instead of a separate homing switch or a hardware limit switch. Set the maximum current (torque) limit through IDN92, to limit the torque applied against the mechanical stop. When motion toward the stop is no longer possible, the following error increases up to 150% of the defined following error and then triggers a movement back to the first zero mark.

Data Length:	2 bytes	Non-Volatile:	No
Data Type:	Unsigned decimal	Write Access:	CP2, CP3, CP4
Minimum:	0	Run-Up Check:	
Maximum:	9	Cyclic Transfer:	
Default:	1	ASCII Param.:	NREF

Additional IDNs, which are used for homing, are:

IDN 41 Homing Velocity, IDN 42 Homing Acceleration

IDN147 Homing Direction

3.191 IDNP3028 (35 796) Output stage enable order

With this IDN you can select the order of SW- and HW-Enable. The default is that the HW-Enable for Sercos has to be set before SW enable will set (HW-Enable order =0) otherwise an F29 error (bit 11 in IDN129) will be set.

To allow SW- before HW-Enable, set this IDN to 1 (HW-Enable order =1).

Data Length:	2 bytes	Non-Volatile:	Yes
Data Type:	Unsigned decimal	Write Access:	CP2, CP3, CP4
Minimum:	0	Run-Up Check:	
Maximum:	1	Cyclic Transfer:	
Default:	0	ASCII Param.:	SERCSET Bit 2

3.192 IDNP3030..3033 (35 798..35 801) Digital Input 1...4

Reflects the state of a digital input (connector X3) in the least significant bit of the IDN.

Data Length:	2 bytes	Non-Volatile:	No
Data Type:	Binary	Write Access:	Read-only
Minimum:		Run-Up Check:	
Maximum:		Cyclic Transfer:	AT
Default:		ASCII Param.:	IN1, IN2, IN3, IN4

3.193 IDNP3034/3035 (35 802/35 803) Analog Input Value 1...2

Returns the differential voltage at an analog input, which may vary from +10V to -10V. Analog input 1 is located on connector X3 (pins 4 and 5). Analog input 2 is located on connector X3 (pins 6 + 7).

Data Length:	2 bytes	Non-Volatile:	No
Data Type:	Signed decimal	Write Access:	Read-only
Minimum:	-10 000	Run-Up Check:	
Maximum:	10 000	Cyclic Transfer:	AT
Default:		ASCII Param.:	ANIN1, ANIN2
Units:	mV	Version:	

3.194 IDNP3036/3037 (35 804/35 805) Digital Output 1...2

The master may set and read the state of a digital output in the least significant bit of the corresponding digital output control/status IDN.

Data Length:	2 bytes	Non-Volatile:	No
Data Type:	Binary	Write Access:	CP2, CP3, CP4
Minimum:	0	Run-Up Check:	
Maximum:	1	Cyclic Transfer:	MDT
Default:	0	ASCII Param.:	O1, O2

3.195 IDNP3038 (35 806) Probe 1 and 2 Enable

Used to arm the position capture mechanism for probe 1 and 2 so that the next valid probing signal edge captures the current position into IDN130/132 or 131/133.

IDNP3038 can only be used if the IDNP3039 is set to 1 by the master. IDNP3038 may be assigned to a RTC bit (MDT control word bit 6 or 7) through IDN301 or IDN303.

This IDN is write-protected while it is assigned to a RTC bit.

Data Length:	2 bytes	Non-Volatile:	No
Data Type:	Binary	Write Access:	CP2, CP3, CP4
Minimum:	0	Run-Up Check:	
Maximum:	1	Cyclic Transfer:	
Default:	0	ASCII Param.:	

3.196 IDNP3039 (35 807) Probe 1 and 2 Control Parameter

The master may use this IDN to configure the probe enable IDNs.
 IDNP3039=0, the master can enable the probes with IDN405 and 406
 IDNP3039=1, the master can enable both probes with IDNP3038 at the same time.

This IDN can not be set to 0		This IDN can not be set to 1	
if the IDNP3038 is actually assigned to a real time control bit through IDN301 or 303		if the IDN405 or 406 is actually assigned to a real time control bit through IDN301 or 303	
if the IDNP3038 is actually set to 1.		if the IDN405 or 406 is actually set to 1.	
Data Length:	2 bytes	Non-Volatile:	No
Data Type:	Binary	Write Access:	CP2, CP3, CP4
Minimum:	0	Run-Up Check:	
Maximum:	1	Cyclic Transfer:	
Default:	0	ASCII Param.:	

3.197 IDNP3040 (35 808) Spline Interpolation Method

Only works in a 500 us cycle for SERCOS position control and when modulo scaling is not set.

Data Length:	2 bytes	Non-Volatile:	No
Data Type:	Binary	Write Access:	CP2, CP3, CP4
Minimum:	0	Run-Up Check:	
Maximum:	1	Cyclic Transfer:	
Default:	0	ASCII Param.:	SERCSET Bit 20

3.198 IDNP3041 (35 809) Position Switch On/Off Parameter

This IDN must set to "1", to use the whole function for the position switch flag parameter (IDN59) and may, if it is selected, the duplication of IDN59 to a digital output.

The value "0" switches off the entire position switch function (refer to IDN59, P3042, 3043 and P3044). A new value will not become active until the parameter is saved to non-volatile memory and a coldstart or warmstart (IDN128) procedure is initiated (refer to IDN59, P3042, 3043, P3044).

Data Length:	2 bytes	Non-Volatile:	Yes
Data Type:	Binary	Write Access:	CP2, CP3
Minimum:	0	Run-Up Check:	
Maximum:	1	Cyclic Transfer:	
Default:	0	ASCII Param.:	WPOS

3.199 IDNP3042 (35 810) Position Switch Enable/Disable Parameter

This IDN can be used to enable or disable the check of each position switch point for the position switch flag parameter (IDN59) (refer to IDN59, P3041, 3043 and P3044).

Bit	Description	Setting	
LSB 0	Position switch point 1 (IDN60)	0 = Disable 1 = Enable Position Switch Flag	
1	Position switch point 2 (IDN61)		
2	Position switch point 3 (IDN62)		
3	Position switch point 4 (IDN63)		
4	Position switch point 5 (IDN64)		
5	Position switch point 6 (IDN65)		
6	Position switch point 7 (IDN66)		
7	Position switch point 8 (IDN67)		
8 - 15		Reserved.	
Data Length:	2 bytes	Non-Volatile:	Yes
Data Type:	Binary	Write Access:	CP2, CP3, CP4
Minimum:	0x0000h	Run-Up Check:	
Maximum:	0x00FFh	Cyclic Transfer:	
Default:	0	ASCII Param.:	WPOSE

3.200 IDNP3043 (35 811) Position Switch Polarity Parameter

With this IDN it is possible to select the polarity for each position switch flag to the corresponding flag bit (IDN59) or the digital output (refer to IDN59, P3041, 3042 and P3044).

Bit	Description	Setting
LSB 0	Position switch point 1 (IDN60)	0 = The flag will set to "1" if the position feedback is greater than or equal to the position switch point. 1 = The flag will set to "0" if the position feedback value is smaller than the position switching point.
1	Position switch point 2 (IDN61)	
2	Position switch point 3 (IDN62)	
3	Position switch point 4 (IDN63)	
4	Position switch point 5 (IDN64)	
5	Position switch point 6 (IDN65)	
6	Position switch point 7 (IDN66)	
7	Position switch point 8 (IDN67)	
8 - 15		Reserved.

With this functionality it is possible to implement a cam function with a positive or negative polarity.

Application Example : Negative Cam Function

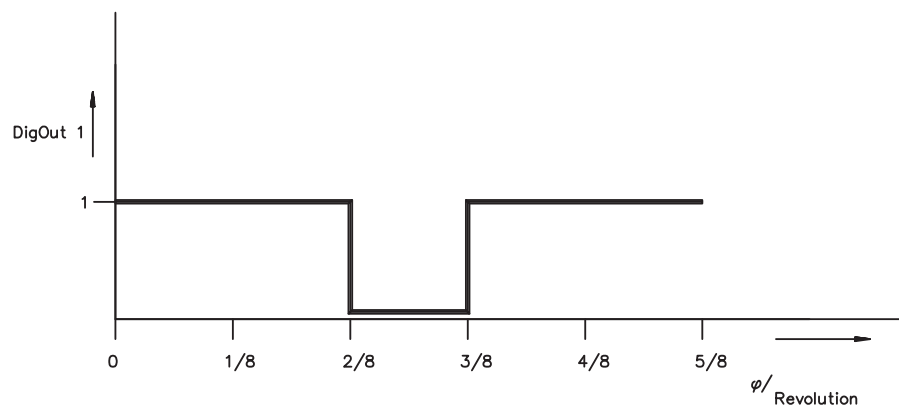

IDN60 = 2/8 Revolution IDNP3041= 0001_{Hex} IDNP3042 = 0003_{Hex}
 IDN61 = 3/8 Revolution IDNP3043 = 0002_{Hex} IDNP3044 = 0
 IDNP3005 = 41 IDNP3007 = 0003_{Hex}

Application Example : Positive Cam Function

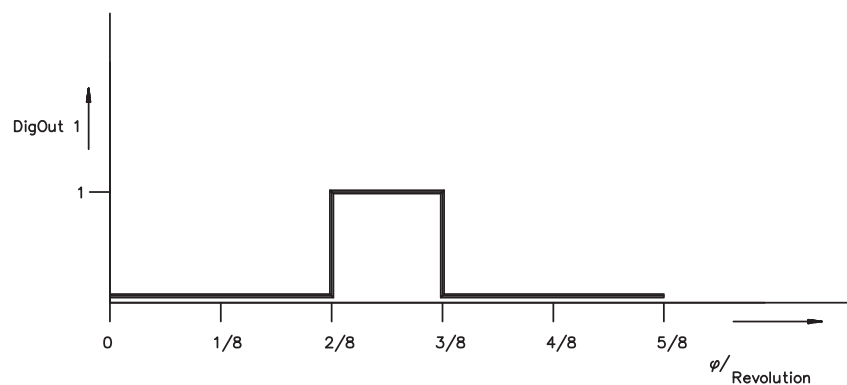

IDN60 = 2/8 Revolution IDNP3041= 0001_{Hex} IDNP3042 = 0003_{Hex}
 IDN61 = 3/8 Revolution IDNP3043 = 0001_{Hex} IDNP3044 = 0
 IDNP3005 = 40 IDNP3007 = 0003_{Hex}

Data Length:	2 bytes	Non-Volatile:	Yes
Data Type:	Binary	Write Access:	CP2, CP3, CP4
Minimum:	0x0000h	Run-Up Check:	
Maximum:	0x00FFh	Cyclic Transfer:	
Default:	0	ASCII Param.:	WPOSP

3.201 IDNP3044 (35 812) Type of Position Switch Parameter

With this IDN it is possible to select the type of the position check for each position switch flag to the corresponding flag bit (IDN59) or the digital output (refer to IDN59, P3041, 3042 and P3043).

Bit	Description	Setting	
LSB 0	Position switch point 1 (IDN60)	0 = The position check is operating the hole time. 1 = The position flag is checked once. The corresponding bit in IDN59 will be set and latched and the corresponding enable bit in P3042 will be reset.	
1	Position switch point 2 (IDN61)		
2	Position switch point 3 (IDN62)		
3	Position switch point 4 (IDN63)		
4	Position switch point 5 (IDN64)		
5	Position switch point 6 (IDN65)		
6	Position switch point 7 (IDN66)		
7	Position switch point 8 (IDN67)		
8 - 15		Reserved.	
Data Length:	2 bytes	Non-Volatile:	Yes
Data Type:	Binary	Write Access:	CP2, CP3, CP4
Minimum:	0x0000h	Run-Up Check:	
Maximum:	0x00FFh	Cyclic Transfer:	
Default:	0	ASCII Param.:	WPOSX

3.202 IDNP3045 (35813) Integral Current Component

This parameter is used to load the integral component of the current controller. This may be required when switching into the torque control operation mode under load, to ensure a transition without jerking.

Data Length:	2 bytes	Non-Volatile:	No
Data Type:	Signed decimal	Write Access:	CP2, CP3, CP4
Minimum:	-1640	Run-Up Check:	
Maximum:	1640	Cyclic Transfer:	
Default:	0	ASCII Param.:	

3.203 IDNP3046 (35814) Motor Number

The command "MNUMBER nr" is used to load a motor data set with the number "nr" from the motor database. If MNUMBER 0 is entered, then no data set will be loaded, but the variable MNUMBER will simply be set to 0. This setting indicates a customer-specific motor data set.

Data Length:	2 bytes	Non-Volatile:	Yes
Data Type:	Signed decimal	Write Access:	CP2, CP3
Minimum:	0	Run-Up Check:	
Maximum:	$2^{15} - 1$	Cyclic Transfer:	
Default:	0	ASCII Param.:	MNUMBER

3.204 IDNP3047 (35 815) Configuration of Digital Cams

This IDN activates digital camming with velocity-dependent correction.

Variables P1...P16 contain position values for position thresholds 1...16.

The standardization of the position depends on settings PGEARI, PGEARO and PRBASE (see also IDN60 + 61).

P1 is specified in IDN60 and the length is specified in IDN 61.

P2 = IDN 60+ IDN 61

Data Length:	2 bytes	Non-Volatile:	No
Data Type:	Signed decimal	Write Access:	CP2, CP3, CP4
Minimum:	0	Run-Up Check:	
Maximum:	1	Cyclic Transfer:	
Default:	0	ASCII Param.:	

3.205 IDNP3048/3049 (35 816/35 817) Correction Values for Digital Cams 1..2 and 3..4

Correction factors in ms for the digital cam. Path correction is calculated according to the current velocity. See also IDN P3047.

Correction = current velocity * time

P1 = IDN60 - correction

P2 = IDN60 + IDN61 - correction

Data Length:	2 bytes	Non-Volatile:	No
Data Type:	Signed decimal	Write Access:	CP2, CP3, CP4
Minimum:	0	Run-Up Check:	
Maximum:	$2^{15} - 1$	Cyclic Transfer:	
Default:	0	ASCII Param.:	

3.206 IDNP3050/3051 (35 818/35 819) Analog Output 1..2 Value

The analog outputs of the amplifier can be read with these IDNs. The configuration of the analog outputs can be set with the Setup Software.

Data Length:	2 bytes	Non-Volatile:	No
Data Type:	Signed decimal	Write Access:	Read-only
Minimum:	-10 000	Run-Up Check:	
Maximum:	10 000	Cyclic Transfer:	AT
Default:		ASCII Param.:	MONITOR1, MONITOR2
Units:	mV	Version:	

3.207 IDNP3052 (35 820) Switch for Acceleration Feed Forward

If the value 1 is set, IDN 348 (ASCII = GPFFT) is also used. The amplifier calculates the velocity feed forward automatically from the position setpoint.

Data Length:	2 bytes	Non-Volatile:	No
Data Type:	Unsigned decimal	Write Access:	CP2, CP3, CP4
Minimum:	0	Run-Up Check:	
Maximum:	1	Cyclic Transfer:	
Default:	0	ASCII Param.:	

3.208 IDNP3053 (35 821) Cyclic Command Value

A free variable that can be used for various communication purposes, e.g. with the internal PLC.

Data Length:	4 bytes	Non-Volatile:	No
Data Type:	Signed decimal	Write Access:	CP2, CP3, CP4
Minimum:	0	Run-Up Check:	
Maximum:	$2^{31} - 1$	Cyclic Transfer:	MDT
Default:	0	ASCII Param.:	DPRVAR9

3.209 IDNP3054 (35 822) Cyclic Actual Value

A free variable that can be used for various communication purposes, e.g. with the internal PLC.

Data Length:	4 bytes	Non-Volatile:	No
Data Type:	Signed decimal	Write Access:	CP2, CP3, CP4
Minimum:	0	Run-Up Check:	
Maximum:	$2^{31} - 1$	Cyclic Transfer:	AT
Default:	0	ASCII Param.:	DPRVAR1

3.210 IDNP3057 (35 825) Off Switch for Digital Cams 1..2

The cams are active when the value is 0 and not active when the value is 1 (refer to IDNP 3047 and IDNP 3048/3049).

Data Length:	2	Non-Volatile:	No
Data Type:	Binary	Write Access:	CP2, CP3, CP4
Minimum:	0	Run-Up Check:	
Maximum:	1	Cyclic Transfer:	
Default:	0	ASCII Param.:	

3.211 IDNP3058 (35 826) Off Switch for Digital Cams 3..4

The cams are active when the value is 0 and not active when the value is 1 (refer to IDNP 3047 and IDNP 3048/3049).

Data Length:	2	Non-Volatile:	No
Data Type:	Binary	Write Access:	CP2, CP3, CP4
Minimum:	0	Run-Up Check:	
Maximum:	1	Cyclic Transfer:	
Default:	0	ASCII Param.:	

3.212 IDNP3060 (35 828) Counter for RDIST - Receive Noise

The counter is incremented by Sercos ASIC interrupts.

Data Length:	4 bytes	Non-Volatile:	No
Data Type:	Unsigned decimal	Write Access:	read-only
Minimum:	0	Run-Up Check:	
Maximum:	2^{32}	Cyclic Transfer:	
Default:	0	ASCII Param.:	

This page has been deliberately left blank.

4 Appendix

4.1 ASCII Reference List

ASCII	IDN	Description
ACC	IDN 136	Positive Acceleration Limit Value
ACCR	IDN 42	Homing Acceleration
ACCUNIT	IDN 160	Scaling Type for Acceleration Data
ACCUNIT	IDN 161	Scaling Factor for Acceleration Data
ACCUNIT	IDN 162	Scaling Exponent for Acceleration Data
ADDR	IDN 96	Slave Arrangement
ALIAS	IDN 142	Application Type
ANIN1 / 2	IDNP 3034 ...3035	(35 802/803) Analog Input 1..2 Value
DEC	IDN 137	Negative Acceleration Limit Value
DECR	IDN 42	Homing Brake Acceleration
DECSTOP	IDNP 3022	(35 790) Emergency Stop Ramp
DICONT	IDN 112	Nominal Current Amplifier
DIPEAK	IDN 110	Peak Current Amplifier
ENCMODE	IDNP 3011	(35 779) Encoder Emulation Mode
ERND	IDN 103	Modulo Value
ERRCODE	IDN 129	Manufacturer Class 1 Diagnostic (MC1D)
EXTLATCH	IDNP 3018	(35 786) Configuration of Probe Position Latch
EXTMUL	IDN 257	Multiplication Factor 2
FBTYPE	IDNP 3010	(35 778) Feedback Type
GP	IDN 104	Position Loop Proportional Gain
GPFV	IDN 296	Velocity Feed Forward Gain
GV	IDN 100	Velocity Loop Proportional Gain
GVTN	IDN 101	Velocity Loop Integral Action Time
I	IDN 84	Torque Feedback Value
I2TLIM	IDN 114	System Load Limit
IN1 ...4	IDN 400	Home Switch
IN1 ...4	IDNP 3030 ...3033	(35 798..801) Digital Input 1..4 Status
IN2	IDN 401	Probe 1
IN2	IDN 402	Probe 2
INXMODE	IDNP 3000 ... 3003	(35 768..771) Digital Input 1..4 Mode
IPEAK	IDN 92	Bipolar Torque Limit
J	IDN 36	Velocity Command Value
KTN	IDN 107	Current Loop Integral Action Time 1
KTN	IDN 120	Current Loop Integral Action Time 2
LATCH1P32	IDN 130	Probe 1 Positive Edge Value
LATCH2P32	IDN 132	Probe 2 Positive Edge Value
LATCH1N32	IDN 131	Probe 1 Negative Edge Value
LATCH2N32	IDN 133	Probe 2 Negative Edge Value
MAXTEMPE	IDN 205	Cooling Error Shutdown Temperature
MAXTEMPH	IDN 203	Amplifier Shutdown Temperature
MICONT	IDN 111	Motor Continuous Stall Current
MICONT	IDN 196	Motor Rated Current
MIPEAK	IDN 109	Peak Motor Current
MLGD	IDN 119	Current Loop Proportional Gain 2
MLGQ	IDN 106	Current Loop Proportional Gain 1
MNAME	IDN 141	Motor Type
MNUMBER	IDNP 3046	Motor Number
MSPEED	IDN 113	Maximum Motor Speed
NREF	IDNP 3027	(35 795) Manufacturer Homing Types
O1, O2	IDNP 3036 ...37	(35 804/805) Digital Output 1..2 Control/Status
OPMODE	IDN 32	Primary Operation Mode
OPMODE	IDN 33	Secondary Operation Mode 1
OVERRIDE	IDN 108	Feedrate Override
OxMODE	IDNP 3005, 3006	(35 773/774) Digital Output 1..2 Mode
OxTRIG	IDNP 3007, 3008	(35 775/777) Digital Output 1..2 Trigger
PE	IDN 189	Following Distance
PEMAX	IDN 159	Monitoring Window
PFB	IDN 51	Position Feedback Value 1 (Motor)

ASCII	IDN	Description
PFB0	IDN 53	Position Feedback Value 2 (External)
PRBASE	IDN 116	Resolution of Rotational Feedback 1 (Motor Feedback)
PRBASE	IDN 79	Rotation Position Resolution
ROFFS	IDN 52	Reference Distance 1
RSTVAR	IDN 262	Command: Load Default Values
SAVE	IDN 264	Command: Back-up Working Memory
SERCSET	IDN 43	Velocity Polarity Parameter
SERCSET	IDNP 3028	(35 796) HW Enable Order
SSTAT	IDN 95	Diagnostics
SWCNFG	IDNP 3004	(35 772) Position Switch Configuration
SWE1	IDN 50	Negative Position Limit Switch
SWE2	IDN 49	Positive Position Limit Switch
TEMPH	IDN 384	Amplifier Temperature
V	IDN 40	Velocity Feedback Value
VBUS	IDN 380	DC Bus Voltage
VLIMN	IDN 39	Negative Velocity Limit Value
VLIM	IDN 91	Bipolar Velocity Limit
VLIMP	IDN 38	Positive Velocity Limit Value
VOSPD	IDNP 3021	(35 789) Overspeed
VREF	IDN 41	Homing Velocity
WPOS	IDNP 3041	(35 809) Position Switch On/Off Parameter
WPOSE	IDNP 3042	(35 810) Position Switch Enable/Disable Parameter
WPOSP	IDNP 3043	(35 811) Position Switch Polarity Parameter
WPOSX	IDNP 3044	(35 812) Type of Position Switch Parameter

4.2

AT	Meaning	MDT	Bedeutung
11	State class 1	36	Target speed value
40	Actual speed value	47	Target position value
51	Actual position of motor encoder	60	Position switching point 1
53	Actual position of external encoder	61	
59	Position switching point parameter	62	
84	Actual torque value	63	
129	Manufacturer state class 1	64	
130	Probe 1 value positive	66	
131	Probe 1 value negative	80	Torque setpoint
132	Probe 2 value positive	81	Additive torque setpoint
133	Probe 2 value negative	92	Bipolar torque limit
144	Status word signal	145	Control word signal
189	Following error	3036	Status Digital Output 1
347	Speed control deviation	3037	Status Digital Output 2
3012	Differential value probe 1	3053	Cyclical setpoint
3013	Differential value probe 2	3055	Cyclical value of the external speed feed forward
3030	Status Digital Input 1	3056	Cyclical value of the external acceleration feed forward
3031	Status Digital Input 2		
3032	Status Digital Input 3		
3033	Status Digital Input 4		
3034	Value Analogue Input 1		
3035	Value Analogue Input 2		
3036	Status Digital Output 1		
3037	Status Digital Output 2		
3054	Cyclical actual value		

4.3

Limit Switch Hardware and Software

The limit switches are activated via SERCSET bit 0 (even / uneven) or IDNP 3015. If bit 0 is set in SERCSET, the drive configures WMASK independently.

INFO

The INxMODEs must be set correctly, i.e. IN3MODE to 2 and IN4MODE to 3.

If the servo amplifier in the limit switch is switched on from standstill, an IDN 99 (CLRFAULT) is issued by the control system in phase 2 during the phase run-up (generally without any user input). This causes the error to be deleted and then not issued again as long as the motor in the limit switch is at standstill, since the bit for the corresponding limit switch is reset internally in WMASK. When the motor is moved out of the limit switch, either manually or via SERCOS, WMASK is automatically set back to the correct value, meaning that errors are again issued the next time the limit switch is actuated. Even if this setting from WMASK were to be saved, it is only the parameter SERCSET that is important!

This handling should ensure that the motor can be moved out of the limit switch, instead of having to be moved by hand. Since one direction of rotation is locked, it is only possible to move out of the limit switch and not further into it.

- Positive position limit IDN 49
- Negative position limit IDN 50
- The software limit switches are activated with IDN 55 (position polarities) bit 4= 0x10 = 16.

IDN 55 is also mapped in SERCSET, meaning that setting bit 8 performs the same function.

Should limit switches be absolutely necessary due to the parameterization in the drive, these are automatically set to the largest possible range. However, this range can be limited.

INFO

The software limit switches (SWEs) are not active until a reference run has been performed or reference point defined.

4.4 Scalings

The following units are supported by the servo amplifier:

IDN 76: Seconds, minutes, inches, meters

The unit for each respective parameter can be freely selected by the user.

4.4.1 Position

IDNs responsible for scaling:

IDN 76	Type of scaling
IDN 77	Scaling factor
IDN 78	Scaling exponent
IDN 79	Rotation position resolution, should correspond to 2^{PRBASE} for simplification

Dependent IDNs and values:

IDN 98	Tracking error
IDN 159	Tracking error window
IDN 336+ C3D bit 6	"In position" message
IDN 57	"In position" window

Types of scaling supported:

Rotational

Linear

Sample configuration for a linear axis with parameter scaling:

S-0-0032	Main operating mode	UINT16	11 (0x000B)
S-0-0076	Type of scaling for position data	UINT16	9 (0x0009)
S-0-0077	Scaling factor for transl. position data	UINT16	1 (0x0001)
S-0-0078	Scaling exponent for transl. position data	INT16	-8
S-0-0123	Feed constant	UINT32	1000000

- PRBASE = IDN79 no longer has any influence. The resolution in increments is now only dependent on the feed constant.
- 10nm has been selected as the unit per increment via IDN 77+78.
- One revolution corresponds to 1,000,000 increments = 1,000,000 x 10nm = 10mm.
- For linear axes, the software limit switches are always activated.
However, these do not have an effect until the reference point has been set.

4.4.2 Speed

IDNs responsible for scaling:

IDN 44	Type of scaling
IDN 45	Factor
IDN 46	Exponent

Dependent IDNs and values:

IDN 41	VREF (Reference travel speed)
IDN 91	VLIM (Maximum speed)
IDN 347	Speed control deviation

Standard scaling:

Rotational:	10^{-4} rpm, although seconds can alternatively be selected via IDN 44.
Linear:	10^{-6} m/min

4.4.3 Power / Torque

IDN 86: only scaling is available here: 0.1% of continuous motor current (MICONT)

Example: MICONT = 6A => LSB = 6mA

4.4.4 Unit conversion, example

Specifications:

IDN 123	= 10.000		
IDN 79	= 1.000.000		
IDN 76	= 0x02 rotative (default)		
PRBASE	= 20bit	= 1048576 Inkr/U	
VREF	= 262 Inkr / 250µs	= 262*4000 Inkr/s	= 1048576 Inkr/s = 60 U/min
IDN 41 Setpoint	= 600.000		

Conversion SERCOS -> ASCII

$$\frac{\text{Setpoint}(\text{IDN41}) * \text{Feedconst}(\text{IDN123}) * (2^{\text{PRBASE}})}{24.000.000 * \text{IDN79}} = \frac{600.000 * 10.000 * 1048.576}{24.000.000 * 1.000.000} = 262$$

Conversion ASCII -> SERCOS

$$\frac{\text{Value}(\text{VREF}) * 24.000.000 * \text{IDN79}}{\text{Feedconst}(\text{IDN123}) * (2^{\text{PRBASE}})} = \frac{262 * 24.000.000 * 1.000.000}{10.000 * 1048.576} = 600.000$$

4.5 Simple basic configuration, example

4.5.1 Position control

Phase 2

IDN	Value	Remarks
IDN 1	1000	NC cycle time
IDN 2	1000	Communication cycle time
IDN 6	St*	AT transmission reaction time
IDN 8	St	Setpoint validity time (t3)
IDN 9	St	Starting address in the AT
IDN 10	St	MDT length
IDN 15	7	Telegram type: User-defined telegram
IDN 16	51	AT configuration list: Actual position value
IDN 24	47	MDT configuration list: Setpoint position
IDN 32	11	Main operating mode: Position without following error
IDN 76	10	Scaling type of position data: Rotational, default
IDN 79	1048576	Rotation position resolution
IDN 89	St	MDT transmission timing

*St = This parameter should be calculated automatically by the control system.

This configuration provides 1048576 increments per revolution. This then has to be correctly interpreted on the control system side.

As a general rule, conversions should be performed on the control system side and not in the servo amplifier, since the computing time in the servo amplifier is needed for other more critical calculations.

All resolutions in 2^x format are easier for our servo amplifiers to handle.

4.5.2 Speed control

Phase 2

IDN	Value	Remarks
IDN 1	1000	NC cycle time
IDN 2	1000	Communication cycle time
IDN 6	St*	AT transmission reaction time
IDN 8	St	Setpoint validity time (t3)
IDN 9	St	Starting address in the AT
IDN 10	St	MDT length
IDN 15	7	Telegram type: User-defined telegram
IDN 16	40, 51	AT configuration list: Actual speed value + actual position value
IDN 24	36	MDT configuration list: Setpoint speed
IDN 32	2	Main operating mode: Position without following error
IDN 44	2	Scaling type of speed data: Rotational, default
IDN 76	10	Scaling type of position data: Rotational, default
IDN 79	1048576	Rotation position resolution
IDN 89	St	MDT transmission timing

*St = This parameter should be calculated automatically by the control system.

The position is now returned to 1048576 increments and the current speed value to 10000 increments per revolution per minute. This means that 10,000,000 corresponds to a speed of 1000 rpm.

The target value specification is scaled accordingly.

4.5.3 Torque control

Phase 2

IDN	Value	Remarks
IDN 1	1000	NC cycle time
IDN 2	1000	Communication cycle time
IDN 6	St*	AT transmission reaction time
IDN 8	St	Setpoint validity time (t3)
IDN 9	St	Starting address in the AT
IDN 10	St	MDT length
IDN 15	7	Telegram type: User-defined telegram
IDN 16	84, 51	AT configuration list: Actual torque value + actual position value
IDN 24	80	MDT configuration list: Setpoint torque
IDN 32	1	Main operating mode: Position without following error
IDN 76	10	Scaling type of position data: Rotational, default
IDN 79	1048576	Rotation position resolution
IDN 89	St	MDT transmission timing

*St = This parameter should be calculated automatically by the control system.

The scaling of the target and actual values is fixed at 0.1% of maximum power. This maximum power depends on the motor being used (MICONTE).

4.6 Real-time bits

IDNs responsible for the real-time bits:

IDN300	Real-time control bit 1
IDN301	Assignment of real-time control bit 1
IDN302	Real-time control bit 2
IDN303	Assignment of real-time control bit 2
IDN304	Real-time status bit 1
IDN305	Assignment of real-time status bit 1
IDN306	Real-time status bit 2
IDN307	Assignment of real-time status bit 2

Configurable IDNs

Control bits		Status bits	
IDN 99	Command: Reset Class 1 Diagnostic (clear fault)	IDN 334	Status Torque limit override
IDN 404	Status of position setpoint	IDN 335	Status Velocity limit override
IDN 405	Probe 1 enable	IDN 336	Status In position
IDN 406	Probe 2 enable	IDN 400	Status Home Switch
IDN 407	Homing enable	IDN 403	Status Position Feedback Value
IDNP 3036	Status digital output 1	IDN 408	Reference mark recorded
IDNP 3037	Status digital output 2	IDN 409	Measured value 1 recorded positive
IDNP 3038	Probe 1 and 2 enable	IDN 410	Measured value 1 recorded negative
IDNP 3057	Off Switch for Digital Cams 1+2	IDN 411	Measured value 2 recorded positive
IDNP 3058	Off Switch for Digital Cams 3+4	IDN 412	Measured value 2 recorded negative

The real-time assignments can be altered at any time to ensure that the information currently needed is always available. The real-time bits are in particular used for the reference run initiated by the control system as a kind of handshake.

INFO

The update rate of the real-time bits is one millisecond.

4.7 Homing

4.7.1 Drive-controlled

If all ASCII parameters are set in such a way that the reference run (homing) works perfectly without SERCOS, for example via the startup software (note incremental scaling via SERCOS), the drive-controlled reference run can be started using the command IDN148.

IDN used	Meaning	ASCII Parameter
IDN 41	Homing speed	VREF
IDN 42	Homing acceleration	ACCR, DECR
IDN 47	Position setpoint	
IDN 52	Reference distance 1 (motor feedback)	ROFFS
IDN 54	Reference distance 2 (external feedback)	ROFFS
IDN 147	Homing parameter	NREF
IDN 148	Command: Amplifier-Controlled Homing	MH
IDN 300 (x=0...3)	Configuration DIGITAL-In 1...4	INxMODE
IDN 403	Position Feedback Value Status	
IDNP 3004	Position Switch Configuration	SWCNFG
IDNP 3027	Homing mode according to ASCII object reference	NREF
IDNP 3068		DREF

Drive-controlled referencing

Sequence	IDN	Meaning
Master sets and releases	IDN 148	Drive-controlled referencing
The cyclical target values are ignored as long as IDN 148 is active.		
Drive deletes the "Position Feedback Value Status" bit	IDN 403	Position Feedback Value Status
The drive switches to internal position control		
The drive accelerates	IDN 42	Homing acceleration
To final speed for Homing	IDN 41	Homing speed
Further settings for Homing	(IDN 147)	Homing Parameters
Homing mode (see ASCII object reference)	IDNP 3027	
The drive brakes behind the position encoder ref. mark and stops at the ref. point	IDN 42	Reference run acceleration
The target position values are based on the ref. mark.	IDN 47	Position setpoint
If the drive is at standstill and the actual position values are based on the ref point.	IDN 403	Position Feedback Value Status
Homing is completed (bit = 0)	IDN 148	Drive-controlled referencing
ROFFS	(IDN 52)	Reference distance 1 (motor feedback)
ROFFS	(IDN 54)	Reference distance 2 (external feedback)

Once homing has been successfully completed, the drive follows the target values. Should homing be interrupted, the actual position values are not based on the ref mark, and the bit for the status of actual position values remains at a low level.

Example (speed setpoint for homing):

With Sercos, the units are switched over to "incremental" in the servo amplifier. For the VREF homing speed, this means:

VREF = Increments per 250µs based on PRBASE

PRBASE = 20bit = 1048576

VREF = 262 => $(262 \cdot 4000) / 1048576$ per sec. => $1048000 / 1048576 = \text{approx. } 1 \text{ rev/s} = 60 \text{ rpm}$

The default scaling on Sercos (Master) is 10,000 rpm

A target value of 600,000 for IDN 41 then corresponds to $600,000 / 10,000 = 60 \text{ rpm} \Rightarrow \text{VREF } 262$

NREF = IDNP 3027

VREF = IDN 41

DREF = IDN 147 Bit 0 (but only DREF 0 or 1 available)
IDNP 3068 also provides 2.

MH = IDN 148

REFMODE = IDNP 3067

INxMODE = IDNP 300x (x = 0...4)

ROFFS = IDN 52 motor encoder

ROFFS = IDN 54 external encoder, if configured via EXTPOS

IDN 147 settings

Bit	Hex	Active at	Supported	Meaning
0	0x0001		Yes	0 = positive direction; 1 = negative direction

DREF, NREFs and set bits in IDN 147

NREF	Bits in 147	Type of reference run
0	0x00E5	Set the reference point to the current position.
1	0x0085	Homing to reference switch with zero mark
2	0x0215	Homing to limit switch with zero mark
3	0x00C5	Homing to reference switch without zero mark
4	0x02E5	Homing to limit switch without zero mark
5	0x0015	within one turn
6	0x00E5	Not adjustable, as no means of differentiation. Always set 0.
7	0x0415	Homing to mechanical stop with zero mark
8	Read error.	Not supported by SECOS standard. Adjustable with IDNP 3027
9	0x04E5	Homing to mechanical stop without zero mark

IDNP 3068 was set to 0 (negative homing direction). With positive direction IDN 147 / Bit 0 will change accordingly.

4.7.2 Control system-controlled

The control system has several ways of referencing the servo amplifier. If the internal drive options are not enough, or if the control system does not support drive-controlled referencing, the control system can perform the referencing itself.

The servo amplifier provides the following signals for this purpose:

IDN 400 – Reference switch (available as real-time status bit)

IDN 407 – Release NC homing; the command must first be started

IDN 408 – Zero impulse status detected (available as real-time status bit)

IDN 173 – Distance to zero impulse

Since it does not issue a zero impulse for resolvers, IDN 408 is immediately set to 1 as soon as the release is issued. Also, IDN173 is set to ASCII "PRD".

If the reference switch in the servo amplifier is to be evaluated, there must be a valid source for a zero impulse. REFMODE must not equal 0 or one of the INxMODEs must be assigned function 12, as otherwise an error message will be issued when starting the command.

Referencing by the control system

With NC-controlled referencing, two commands are available:

IDN 146 – NC-controlled referencing

IDN 172 – Movement into the reference system

These commands can also be used if, for example, the control system calculates the movement and then writes this to the drive.

Command IDN146 "NC-controlled referencing"

For correct processing of the command (IDN 146), the following assignments to the real-time control or status bits must be made **before the start of the command**:

- Real-time control bit (1 or 2): Reference release (IDN 407)

- Real-time status bit (1 or 2): Reference mark recorded (IDN 408).

Once the reference switch is connected to the servo amplifier, the following assignment is still necessary:

- Real-time status bit (1 or 2): Reference switch (IDN 400).

With NC-controlled referencing, we distinguish between two cases:

- The reference switch is connected to the control system, but the servo amplifier only evaluates the "reference release" signal.
- The reference switch is connected to the control system. The servo amplifier registers the IDN 400 reference switch with the control system via the real-time status bit 2. The control system sets the IDN 407 reference release via the real-time control bit. There are two options here:
 - The servo amplifier evaluates the IDN 407 reference release.
 - The servo amplifier evaluates the IDN 407 reference release **and** the IDN 400 reference switch.

4.8 Cam-Switch

This function generates up to 4 virtual cams, which can be altered cyclically (online). A cam consists of the starting point and the length. The starting point is issued cyclically by the control system and the length can be altered via the service channel.

INFO

Limitations: Only 16/20bit resolution can be used, even with modulo.

The following ASCII parameters must be set in the drive:

ASCII	Value	IDN
WPOSP	34	IDNP 3043
WPOS	1	IDNP 3041
WPOSE	255	IDNP 3042
O1MODE	41	IDNP 3005
O2MODE	41	IDNP 3006
O2TRIG	48 (= 0x30h)	IDNP 3007
O1TRIG	3 (= 0x03h)	IDNP 3008

IDN 60	P1 position switching point 1	Must be configured cyclically (MDT)
IDN 61	P2 position switching point 2	Must be written via the SC
IDN 62	P3 position switching point 3	Must be configured cyclically (MDT)
IDN 63	P4 position switching point 4	Must be written via the SC
IDN 64	P5 position switching point 5	Must be configured cyclically (MDT)
IDN 65	P6 position switching point 6	Must be written via the SC
IDN 66	P7 position switching point 7	Must be configured cyclically (MDT)
IDN 67	P8 position switching point 8	Must be written via the SC
IDNP 3047	CAM configuration	
IDNP 3048	CAM configuration	
IDNP 3049	CAM configuration	
IDNP 3057	Disable CAM 1+2, both can only be switched on/off at the same time	
IDNP 3058	Disable CAM 3+4, both can only be switched on/off at the same time	

Example

Settings:

	Start	End
CAM 1	0	100.000
CAM 2	524.000	624.000
CAM 3	262.000	362.000
CAM 4	768.000	868.000

blue: PFB
 red: CAM 1+2
 green: CAM 3+4

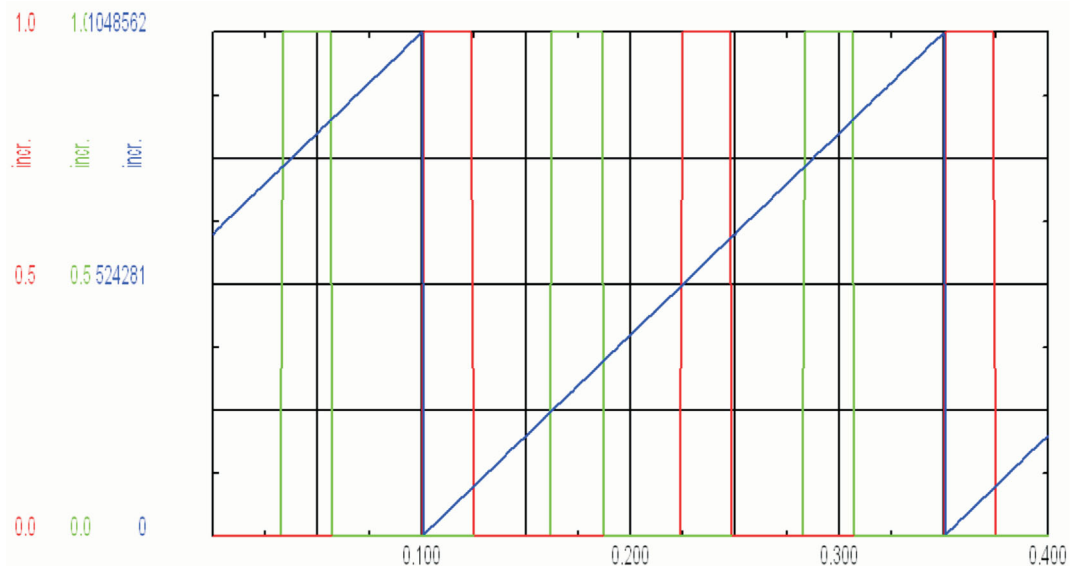

4.9 Linearaxes

IDN used	Meaning
IDN 76	0x01 linear with std. scaling 10^{-7} m/incr
	0x09 linear with parameter scaling
	0x81 linear with std. scaling 10^{-7} m/incr + modulo
	0x89 linear with parameter scaling + modulo
	0xC1 linear with std. scaling 10^{-7} m/incr + modulo + scaling at load
0xC9 linear with parameter scaling + modulo + scaling at load	
IDN 77	Linear Position Data Scaling Factor
IDN 78	Linear Position Data Scaling Exponent
IDN 79	Rotational position resolution
IDN 103	Modulo value
IDN 121	Input Revolutions of Load Gear
IDN 122	Output Revolutions of Load Gear
IDN 123	Linear feed constant in selected units, i.e. travel per revolution

Since with linear axes the absolute travel is limited, the servo amplifier ensures that there is no overrun in the actual position by setting the software limit switches. Due to scaling, the internal drive values in SWE1 and SWE2 differ from the values determined via SERCOS.

4.10 Directions of rotation

ASCII "DIR"

With this command, the polarities can be rotated directly in the servo amplifier. This has an effect on the display in the GUI! It is then no longer necessary to rotate using SERCOS.

IDN 43 – Speed polarities

Bit		Meaning
Bit 0	Velocity setpoint	0 Not inverted
		1 Inverted
Bit 1	Additive velocity setpoint	0 Not inverted
		1 Inverted
Bit 2	Velocity actual value 1	0 Not inverted
		1 Inverted
Bit 3	Velocity actual value 2	0 Not inverted
		1 Inverted
Bit 4-15	reserved	

IDN 55 – Position polarities

INFO

Rotations via IDN 55 and IDN 43 only affect SERCOS and do not have an effect in the servo amplifier itself. The display in the startup software then no longer matches the display via SERCOS.

IDN 55 is saved in SERCSET bits 4-11, meaning that settings have an effect here, even if these are later no longer desired. IDN 55 then has to be explicitly altered in phase 2 and the SAVE command executed.

Bit		Meaning
Bit 0	Position setpoint	0 Not inverted
		1 Inverted
Bit 1	Reserved: Additive position setpoint	0 Not inverted
		1 Inverted
Bit 2	Position actual value 1	0 Not inverted
		1 Inverted
Bit 3	Position actual value 2	0 Not inverted
		1 Inverted
Bit 4	Position limit values (software limit switches)	0 deactivated
		1 activated*
Bit 4-15	reserved	

4.11 External position control

IDN used	Meaning
IDN 32	Primary Operation Mode
IDN 53	Position Feedback Value 2 (External Feedback)
IDN 76	Position Data Scaling Type
IDN 79	Rotational Position Resolution
IDN 117	Resolution of Rotational Feedback 2 (External Feedback)
IDN 257	Multiplication Factor 2
IDN 121	Input Revolutions of Load Gear
IDN 122	Output Revolutions of Load Gear
IDN 123	Feed Constant
IDNP 3017	Position Feedback Type (ASCII: EXTPOS)

The resolution of the external encoder is the number of lines per revolution it can supply. In standard configuration, the multiplication factor can remain 1. The resolution used via SERCOS is still set via IDN 79 for rotational and IDN 123 for linear scaling. The encoder lines are then scaled to this resolution.

Example:

Motor encoder: Resolver FBTYPE 0
 External encoder: 5 V ROD encoder on plug X5 => EXTPOS 3
 Position resolution: 20bit via SERCOS

INFO

EXTPOS uses positive values for active control and negative values when the external encoder is only to be read in.

If the external encoder is being used for active control, PFB0 is copied to PFB and the motor encoder then only supplies position data via PRD. This is limited to one revolution (like modulo), as it only contributes to the commutation.

Startup parameters

IDN	Name	Type	Value
S-0-0032	Main operating mode	UINT16	12 (0x000C)
S-0-0055	Position polarities	UINT16	0 (0x0000)
S-0-0076	Type of scaling for position data	UINT16	74 (0x004A)
S-0-0117	Resolution of Rotational Feedback 2	UINT32	500
S-0-0079	Rotational position resolution	UINT32	1048576
P-0-3017	Position Feedback Type	INT16	3

4.12 Quadratic interpolation

Quadratic interpolation is used for “softer” evening out of target value jumps. The SERCOS cycle time must be 500 μs and the position control must be used. The interpolation method is then activated with IDNP 3040 = 1. With modulo it **cannot** be used.

An internal table with sinus-shaped trajectory is used as reference. Since the cycle time is 500μs and the cycle time of the internal position controller is 250μs, the target value is only updated every second time.

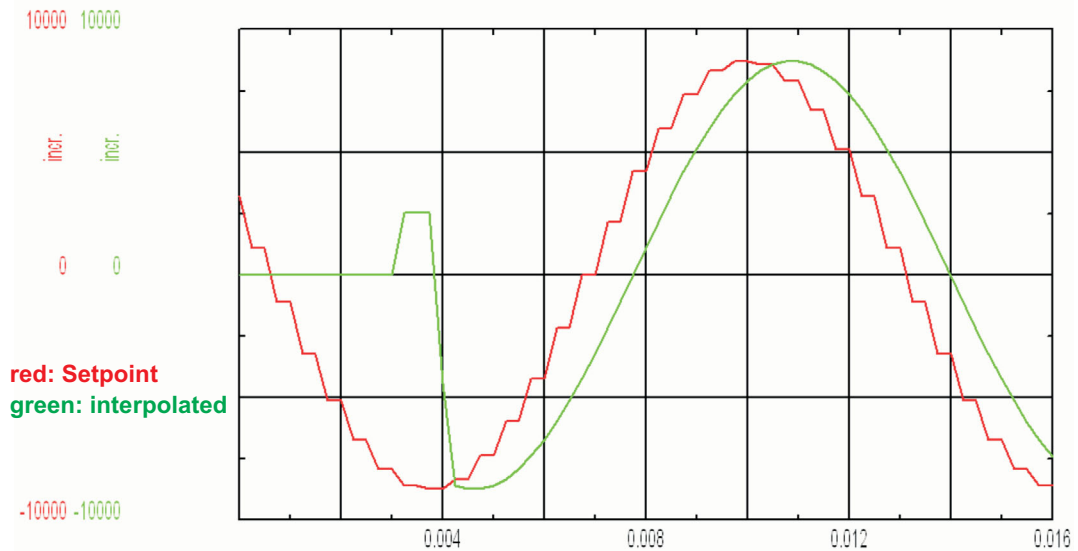

Setpoint	S_SETH
-8721	-4387
-8310	-8583
-8310	-8720
-7378	-8721
-7378	-8581
-5982	-8310
-5982	-7902
-4210	-7378
-4210	-6727
-2173	-5982
-2173	-5129
0	-4210
0	-3209
2173	-2173
2173	-1087

Setpoint	S_SETH
4210	0
4210	1103
5982	2173
5982	3224
7378	4210
7378	5143
8310	5982
8310	6738
8721	7378
8721	7910
8583	8310
8583	8584
7906	8721
7906	8720
6733	8583

Setpoint	S_SETH
6733	8306
5136	7906
5136	7372
3217	6733
3217	5975
1095	5136
1095	4202
-1095	3217
-1095	2165
-3217	1095
-3217	-8
-5136	-1095
-5136	-2181
-6733	-3217
-6733	-4217

4.13 Gearing and transmission ratios for linear and rotational axes

IDN used	Meaning
IDN 76	scaling of the position data
IDN 121	Gearing input revolutions
IDN 122	Gearing output revolutions

IDN 121+122 only work when IDN 76 bit 7 (0x0040) = "data reference at load" is set. However, this does not automatically mean that an external encoder is being used or even has to be used.

INFO

Does not work with modulo.
The travel is limited via software limit switches, since overrun can occur.

Example:

IDN 121 = 1
IDN 122 = 2
Transmission ratio 2:1 (IDN122 / IDN121)

IDN 76 Bit 6 = 0

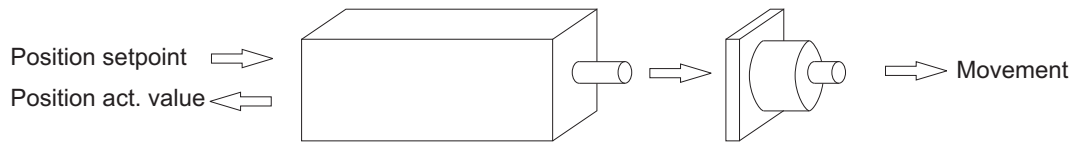

INFO

Gearing factor 1:2 with interpretation of the setpoint from the motor to the load.
With a setpoint of 1 revolution, the motor shaft turns 2 revolutions. The SERCOS actual position value sent back is for just 1 revolution of the motor.

IDN 76 Bit 6 = 1

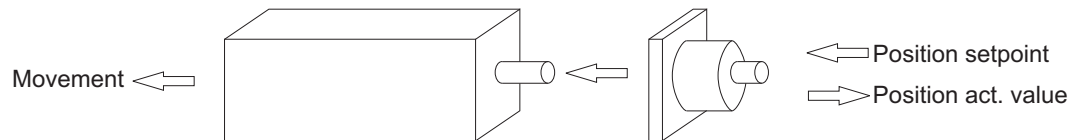

INFO

Gearing factor 1:2 with interpretation of the setpoint from the load to the motor.
With a setpoint of 2 revolutions, the motor shaft turns 1 revolution.
The SERCOS actual position value sent back is for 2 revolutions of the load.

4.14 Troubleshooting

4.14.1 When does F29 occur?

- Every time the phases are switched back, i.e. also every time the control system is intentionally switched off!
- If two consecutive (back-to-back) MSTs or MDTs fail
- If the software enable is issued before the hardware enable without it having been configured with IDNP 3016
- If the SERCOS-ASIC has an unexpected version number (unlikely).
- If the hardware enable switches to 0V with servo amplifiers released via SERCOS.
- In the event of cable break.
- Control system wants to switch to a phase greater than 4.
- The next phase requested by the control system would skip one or more phases.
- Switching is to be performed to phase 3 without the command IDN127 having first been successfully executed.
- Switching is to be performed to phase 4 without the command IDN128 having first been successfully executed.

4.14.2 Phase 0 or phase 1 is not possible

- Do all servo amplifiers have the same baud rate (SBAUD)?
- Do all servo amplifiers have a unique address (ADDR)?
- The light output (SLEN) might not be set optimally. The light output can effectively only be set in the following steps:
0 1-14 15- 30 31-44 45...
- With 16 Mbaud, 30 is the maximum light output and the only steps available are 0-10 and 11-30.

4.14.3 It is not possible to switch up from phase 2 to phase 3

IDN 21 contains all parameters that prevent phase runup. These are predominantly timings, which come from the control system and are checked in the drive. However, the configuration of the AT and MDT is also checked here with regard to the operating mode. Speed control stipulates that the MDT also contains the target speed value.

The following parameters MUST be written by the control system:

IDN 1	NC cycle time	Must be the same; larger than 250µs; above 1ms only whole digits, no decimals
IDN 2	Sercos cycle time	
IDN 6	AT timing	Are all required values on the operating mode and telegram type programmed? And do these match the length?
IDN 9	Start address in the MDT	
IDN 10	Length of the MDT	
IDN 15	Telegram type	
IDN 16	AT configuration	
IDN 24	MDT configuration	
IDN 32	Main operating mode	
IDN 89	MDT timing	

4.14.4 It is not possible to switch up from phase 3 to phase 4

IDN 22 lists the IDNs which prevent switching up. In this phase these are weighting values and general settings that contradict one another.

For example:

IDN 44,45,46	Weighting values for speed control
IDN 76,79,103,123	Weighting values for position control
IDN 121,122	Gearing factors

4.15 IDN type-sorted

4.15.1 General

IDN0030 Manufacturer Version	27
IDN0140 Controller Type.	51
IDN0141 Motor Type	52
IDN0142 Application Type	52
IDN0192 IDN List of Back-up Operation Data	59
IDN0262 Load Default Values	61
IDN0264 Back-up Working Memory	61
IDN0288 IDN List of Data Programmable in CP2	61
IDN0289 IDN List of Data Programmable in CP3	62
IDNP3016 Reset Command Consequence	75
IDNP3019 Select of the FPGA Program	77
IDNP3025 Command DIR	78
IDNP3026 Non-Volatile Memory Data Checksum	78
IDNP3028 Output Stage Enable Order.	80
IDNP3053 Cyclic Command Value.	84
IDNP3054 Cyclic Actual Value	84

4.15.2 Acceleration / Deceleration Control

IDN0042 Homing Acceleration	30
IDN0136 Positive Acceleration Limit Value.	51
IDN0137 Negative Acceleration Limit Value	51
IDN0138 Bipolar Acceleration Limit Value	51
IDN0160 Acceleration Data Scaling Type	54
IDN0161 Acceleration Data Scaling Factor	54
IDN0162 Acceleration Data Scaling Exponent	55
IDNP3022 Emergency Stop Rate	77

4.15.3 Torque Control

IDN0032 Primary Operation Mode	28
IDN0033 Secondary Operation Mode 1	28
IDN0080 Torque Setpoint Value	37
IDN0081 Additive Torque Setpoint.	38
IDN0084 Torque Feedback Value	38
IDN0086 Torque/Force Data Scaling Type.	38
IDN0092 Bipolar Torque Limit	40
IDN0093 Scaling Factor Torque	40
IDN0094 Scaling Exponent Torque	40
IDN0106 Current Loop Proportional Gain 1	43
IDN0107 Current Loop Integral Action Time 1	43
IDN0110 Amplifier Peak Current	44
IDN0112 Amplifier Rated Current	44
IDN0114 System Load Limit	44
IDN0119 Current Loop Proportional Gain 2	45
IDN0120 Current Loop Integral Action Time 2	45
IDN0126 Torque Treshold Tx	46
IDN0348 Gain for Acceleration Feed Forward	65
IDNP3020 System Rated Current	77
IDNP3045 Integral Current Component	83
IDNP3052 Switch for Acceleration Feed Forward	84

4.15.4 Fault & Safety Detection

IDN0091 Bipolar Velocity Limit	39
IDN0092 Bipolar Torque Limit	40
IDN0095 Diagnostic Message	40
IDN0099 Reset Class 1 Diagnostic (clear fault)	41
IDN0114 System Load Limit	44
IDN0129 Manufacturer Class 1 Diagnostic	47
IDN0159 Monitoring Window	54
IDN0203 Amplifier Shutdown Temperature	59
IDN0205 Cooling Error Shutdown Temperature	60
IDN0208 Temperature Data Scaling Type	60
IDN0312 Temperature Warning Motor Status	64
IDN0323 Status "Target position outside of Travel Range"	65
IDN0380 DC Bus Link Voltage	66
IDN0384 Amplifier Temperature	66
IDNP3019 Select of the FPGA Program	77
IDNP3020 System Rated Current	77
IDNP3021 Over Speed	77
IDNP3060 Counter for RDIST-Receive Noise	85

4.15.5 Feedback Devices

IDN0116 Resolution of Rotational Feedback 1 (motor feedback)	45
IDN0117 Resolution of Rotational Feedback 2 (external feedback)	45
IDN0121 Input Revolutions of Load Gear	46
IDN0122 Output Revolutions of Load Gear	46
IDN0256 Multiplication Factor 1	60
IDN0257 Multiplication Factor 2	60
IDNP3010 Feedback Type	71
IDNP3017 Position Feedback Type	76
IDNP3018 Configuration of the Position Latch	76

4.15.6**Velocity Control**

IDN0032 Primary Operation Mode	28
IDN0033 Secondary Operation Mode 1	28
IDN0036 Velocity Command Value	29
IDN0038 Positive Velocity Limit Value	29
IDN0039 Negative Velocity Limit Value	29
IDN0040 Velocity Feedback Value	29
IDN0041 Homing Velocity	30
IDN0043 Velocity Polarity Parameter	30
IDN0044 Velocity Data Scaling Type	31
IDN0045 Velocity Data Scaling Factor	31
IDN0046 Velocity Data Scaling Exponent	31
IDN0091 Bipolar Velocity Limit	39
IDN0100 Velocity Loop Proportional Gain	42
IDN0101 Velocity Loop Integral Action Time	42
IDN0296 Velocity Feed-Forward Gain	62
IDN0347 Velocity Control deviation	65
IDN0392 Velocity Feedback Filter Time Constant	66
IDNP3015 Hardware Limit Switch Consequence	75
IDNP3021 Over Speed	77
IDNP3023 2nd Filter Time Constant Velocity Control	78
IDNP3024 Proportional Gain Velocity Control	78

4.15.7**Monitoring & Troubleshooting**

IDN0011 Class 1 Diagnostic	22
IDN0012 Class 2 Diagnostic	23
IDN0013 Class 3 Diagnostic	23
IDN0014 Interface Status	24
IDN0095 Diagnostic Message	40
IDN0096 Slave Arrangement	40
IDN0097 Class 2 Diagnostic Mask	41
IDN0098 Class 3 Diagnostic Mask	41
IDN0099 Reset Class 1 Diagnostic (clear fault)	41
IDN0129 Manufacturer Class 1 Diagnostic	47
IDN0181 Manufacturer Class 2 Diagnostic	57
IDN0182 Manufacturer Class 3 Diagnostic	57
IDN0271 Amplifier ID	61
IDN0301 Allocation of Real-Time Control Bit 1	63
IDN0303 Allocation of Real-Time Control Bit 2	63
IDN0304 Real-Time Status Bit 1	63
IDN0305 Allocation of Real-Time Status Bit 1	64
IDN0306 Real-Time Status Bit 2	64
IDN0307 Allocation of Real-Time Status Bit 2	64

4.15.8

Configurable I/O

IDN0130 Probe 1 Positive Edge Value	48
IDN0131 Probe 1 Negative Edge Value	48
IDN0132 Probe 2 Positive Edge Value	48
IDN0133 Probe 2 Negative Edge Value	48
IDN0400 Home Switch Status	66
IDN0401 Probe 1 Status	66
IDN0402 Probe 2 Status	67
IDN0405 Probe 1 Enable.	67
IDN0406 Probe 2 Enable.	67
IDN0409 Probe 1 Positive Edge Latched Status	68
IDN0410 Probe 1 Negative Edge Latched Status	68
IDN0411 Probe 2 Positive Edge Latched Status	68
IDN0412 Probe 2 Negative Edge Latched Status	69
IDNP3000...3001 Digital Input 1...4 Configuration	69
IDNP3004 Position Switch Configuration.	69
IDNP3005/3006 Digital Output 1/2 Configuration	70
IDNP3007/3008 Digital Output Trigger	70
IDNP3014 Probe Difference Control Parameter	73
IDNP3030...3033 Digital Input 1...4	80
IDNP3034/3035 Analog Input Value 1/2	80
IDNP3036/3037 Digital Output 1/2	80
IDNP3038 Probe 1 and 2 Enable.	80
IDNP3039 Probe 1 and 2 Control Parameter	81
IDNP3041 Position Switch On/Off Parameter	81
IDNP3042 Position Switch Enable/Disable Parameter.	81
IDNP3043 Position Switch Polarity Parameter	82
IDNP3044 Type of Position Switch Parameter	83
IDNP3048/3049 Correction Values for digital Cams 1/2 and 3/4	84
IDNP3050 Analog Output 1/2 Value	84
IDNP3057 Off Switch for Cams 1/2	85
IDNP3058 Off Switch for Cams 3/4	85

4.15.9

Position Control

IDN0032 Primary Operation Mode	28
IDN0033 Secondary Operation Mode 1	28
IDN0041 Homing Velocity	30
IDN0042 Homing Acceleration	30
IDN0047 Position Setpoint Value.	32
IDN0049 Positive Position Limit	32
IDN0050 Negative Position Limit	32
IDN0051 Position Feedback Value 1 (Motor Feedback)	32
IDN0052 Reference Distance 1 (Motor Feedback).	33
IDN0053 Position Feedback Value 2 (External Feedback).	33
IDN0054 Reference Distance 2 (External Feedback)	33
IDN0055 Position Polarity Parameter	34
IDN0057 Position Window	34
IDN0059 Position Switch Flag Parameter	35
IDN0060...67 Position Switch Point 1...8.	35
IDN0076 Position Data Scaling Type.	36
IDN0077 Linear Position Data Scaling Factor	37
IDN0078 Linear Position Data Scaling Exponent.	37
IDN0079 Rotational Position Resolution	37
IDN0103 Module Value.	42
IDN0104 Position Loop Proportional Gain	42
IDN0105 Position Loop Integral Action Time.	43
IDN0108 Feedrate Override	43
IDN0121 Input Revolutions of Load Gear	46
IDN0122 Output Revolutions of Load Gear	46
IDN0123 Feed Constant	46
IDN0146 NC-Controlled Homing	52
IDN0147 Homing Parameter	53
IDN0148 Amplifier-Controlled Homing	53
IDN0159 Monitoring Window.	54
IDN0169 Probe Control Parameter.	55
IDN0170 Probing.	56
IDN0179 Probe Position Latch Status	56
IDN0189 Following Distance	59
IDN0197 Command: Set coordinate system	59
IDN0298 Home Switch Distance	62
IDN0336 Status "In Position".	65
IDN0403 Position Feedback Status	67
IDN0447 Command: Set absolute position.	69
IDNP3011 Encoder Emulation Configuration.	71
IDNP3012 Difference Probe Edge Value 1.	72
IDNP3013 Difference Probe Edge Value 1.	72
IDNP3017 Position Feedback Type	76
IDNP3027 Manufacturer Homing Modes.	79
IDNP3040 Square Interpolation Method	81
IDNP3047 Configuration of Digital Cams.	83

4.15.10 Motor Compatibility

IDN0109 Motor Peak Current	43
IDN0111 Motor Continuous Stall Current	44
IDN0113 Maximum Motor Speed.	44
IDN0196 Motor Rated Current	59
IDNP3009 Release Motor Brake	70
IDNP3046 Motor Number	83

4.15.11 System Communication

IDN0001 Control Unit Cycle Time	20
IDN0002 Communication Cycle Time	20
IDN0003 Shortest AT Transmission Starting Time	20
IDN0004 Transmit/Receive Transition Time	20
IDN0005 Minimum Feedback Processing Time	21
IDN0006 Transmission Starting Time	21
IDN0007 Feedback Acquisition Capture Point	21
IDN0008 Command Value Valid Time	21
IDN0009 Position of Data Record in MDT	22
IDN0010 Length of MDT	22
IDN0015 Telegram Type Parameter	25
IDN0016 Configuration List of ET Cyclic Data	25
IDN0017 IDN List of All Operation Data	25
IDN0018 IDN List of Operation Data for CP2	26
IDN0019 IDN List of Operation Data for CP3	26
IDN0021 IDN List of Invalid Operation Data for CP2	26
IDN0022 IDN List of Invalid Operation Data for CP3	26
IDN0024 Configuration List of MDT Cyclic Data	26
IDN0025 IDN List of All Procedure Commands	27
IDN0028 MST Error Counter	27
IDN0029 MDT Error Counter	27
IDN0088 Receive to Receive Recovery Time	38
IDN0089 MDT Transmission Starting Time	39
IDN0090 Setpoint Value Processing Time	39
IDN0096 Slave Arrangement.	40
IDN0097 Class 2 Diagnostic Mask	41
IDN0098 Class 3 Diagnostic Mask	41
IDN0127 Communication Phase 3 Transition Check.	47
IDN0128 Communication Phase 4 Transition Check.	47
IDN0134 Master Control Word	49
IDN0135 Amplifier Status Word	50
IDN0143 System Interface Version.	52
IDN0185 Maximum Length of AT Configurable Data.	57
IDN0186 Maximum Length of MDT Configurable Data.	57
IDN0187 List of AT Configurable Data IDNs	58
IDN0188 List of MDT Configurable Data IDNs	58
IDN0301 Allocation of Real-Time Control Bit 1	63
IDN0303 Allocation of Real-Time Control Bit 2	63
IDN0304 Real-Time Status Bit 1	63
IDN0305 Allocation of Real-Time Status Bit 1	64
IDN0306 Real-Time Status Bit 2	64
IDN0307 Allocation of Real-Time Status Bit 2	64
IDN0376 Supported Baud Rates	65

This page has been deliberately left blank.

Service

We are committed to quality customer service. In order to serve in the most effective way, please contact your local sales representative for assistance.
If you are unaware of your local sales representative, please contact the Customer Support.

Europe

KOLLMORGEN Customer Support Europe
Internet www.kollmorgen.com
E-Mail technik@kollmorgen.com
Tel.: +49 (0)2102 - 9394 - 0
Fax: +49 (0)2102 - 9394 - 3155



KOLLMORGEN
UK Website



European
Product WIKI

North America

KOLLMORGEN Customer Support North America
Internet www.kollmorgen.com
E-Mail support@kollmorgen.com
Tel.: +1 - 540 - 633 - 3545
Fax: +1 - 540 - 639 - 4162



KOLLMORGEN
US Website



KOLLMORGEN
Developer Network

Asia

KOLLMORGEN
Internet www.kollmorgen.com
E-Mail sales.china@kollmorgen.com
Tel: +86 - 400 661 2802
Fax: +86 - 21 6071 0665



KOLLMORGEN
CN Website