

# DeviceNet™

Fieldbus Interface for S300 / S600 / S700



Edition 11/2018  
Translation of the original manual



For safe and proper use,  
follow these instructions.  
Keep them for future reference.

## Previous editions

<b>Edition</b>	<b>Comments</b>
12 / 2002	First edition
07 / 2003	New Layout, Object description altered, minor corrections, valid from firmware version S600 5.55, Declaration of Conformity with DeviceNet™ Specification
03 / 2004	several corrections, valid also for S300 from firmware version 1.0
01 / 2006	chapter 1 restructured, several changes, wording updated
09 / 2006	new design
08 / 2007	Branding, S700 new, standards
12 / 2009	Branding, minor corrections, symbol acc. to ANSI Z535
12 / 2010	Company name
07 / 2014	Design cover page, warning notes updated
04/2016	Safe voltage changed to 50V, warning symbols updated, european directives updated
07/2016	Use as directed updated
11/2018	Layout of the warning notes updated, user expertise updated, new readers note on cover page

**Technical changes to improve the performance of the equipment may be made without prior notice !**

All rights reserved. No part of this work may be reproduced in any form (by photocopying microfilm or any other method) or processed, copied or distributed by electronic means, without the written permission of Kollmorgen Europe GmbH.

		Page
<b>1</b>	<b>General</b>	
1.1	About this manual	7
1.2	Target group	7
1.3	Hints for the online edition (PDF format)	7
1.4	Use as directed	8
1.5	System requirements	8
1.6	Symbols used	8
1.7	Abbreviations used	9
1.8	Application of this manual	9
1.9	Basic features implemented through DeviceNet	10
<b>2</b>	<b>Installation / Setup</b>	
2.1	Installation	11
2.1.1	Install the expansion card	12
2.1.1.1	Combined Module / Network Status LED	12
2.1.1.2	Front view	12
2.1.1.3	Connection technology	12
2.1.1.4	Bus cable	13
2.1.1.5	Connection diagram	15
2.1.1.6	Setup of station address	15
2.1.1.7	Setup of transmission rate	15
2.1.1.8	Controller setup	15
2.2	Setup	16
2.2.1	Guide to Setup	16
2.2.2	Error handling	16
2.2.3	Response to BUSOFF communication faults	17
<b>3</b>	<b>DeviceNet Overview</b>	
3.1	Functionality Chart	19
3.2	Overview of Explicit and Polled I/O (assembly) messages	19
3.3	Motion Objects with Explicit Messaging	20
3.3.1	Object: Parameter	20
3.3.2	Object: Position Controller Supervisor	20
3.3.3	Object: Position Controller	20
3.3.4	Object: Block Sequencer	20
3.3.5	Object: Command Block	20
3.4	I/O Objects	21
3.4.1	Object: Discrete Input Point	21
3.4.2	Object: Discrete Output Point	21
3.4.3	Object: Analog Input Point	21
3.4.4	Object: Analog Output Point	21
3.5	Communication Objects	22
3.5.1	Object: Identity	22
3.5.2	Object: Message Router	22
3.5.3	Object: DeviceNet	22
3.5.4	Object: Assembly	22
3.5.5	Object: Explicit Connection	22
3.5.6	Object: Polled I/O Connection	22
3.6	Firmware Version	23
3.7	Supported Services	23
3.8	Data Types	23
3.9	Saving to Non-volatile Memory	23

<b>4</b>	<b>Explicit messages</b>	
4.1	Position Controller Supervisor Object (class 0x24)	25
4.1.1	Error Codes	25
4.1.1.1	Object State Conflicts – 0x0C	25
4.1.2	Supervisor Attributes	25
4.1.2.1	Attribute 0x05: General Fault	25
4.1.2.2	Attribute 0x0E: Index Active Level	26
4.1.2.3	Attribute 0x15: Registration Arm	26
4.1.2.4	Attribute 0x16: Registration Input Level	26
4.1.2.5	Attribute 0x64: Fault Code	26
4.1.2.6	Attribute 0x65: Clear Faults	26
4.2	Position Controller Object (class 0x25)	27
4.2.1	Error Codes	27
4.2.1.1	Object State Conflicts – 0x0C	27
4.2.2	Position controller attributes	27
4.2.2.1	Attribute 0x01: Number of Attributes	27
4.2.2.2	Attribute 0x02: Attribute List	27
4.2.2.3	Attribute 0x03: opmode	28
4.2.2.4	Attribute 0x06: Target Position	28
4.2.2.5	Attribute 0x07: Target Velocity	28
4.2.2.6	Attribute 0x08: Acceleration	28
4.2.2.7	Attribute 0x09: Deceleration	28
4.2.2.8	Attribute 0x0A: Move Type	29
4.2.2.9	Attribute 0x0B: Trajectory Start/Complete	29
4.2.2.10	Attribute 0x0C: In Position	29
4.2.2.11	Attribute 0x0D: Actual Position	29
4.2.2.12	Attribute 0x0E: Actual Velocity	29
4.2.2.13	Attribute 0x11: Enable	29
4.2.2.14	Attribute 0x14: Smooth Stop	30
4.2.2.15	Attribute 0x15: Hard Stop	30
4.2.2.16	Attribute 0x16: Jog Velocity	30
4.2.2.17	Attribute 0x17: Direction	30
4.2.2.18	Attribute 0x18: Reference direction	30
4.2.2.19	Attribute 0x19: Torque	31
4.2.2.20	Attribute 0x28: Feedback resolution	31
4.2.2.21	Attribute 0x29: Motor resolution	31
4.2.2.22	Attribute 0x65: Save Parameters	31
4.2.2.23	Attribute 0x66: Amplifier Status	32
4.2.2.24	Attribute 0x67: Trajectory Status	32
4.3	Parameter Object (class 0x0F)	33
4.3.1	Error Codes	33
4.3.2	Parameter Attributes	33
4.3.2.1	Attribute 0x01: Parameter Value	33
4.3.2.2	Attribute 0x04: Descriptor	33
4.3.2.3	Attribute 0x06: Data Length	34
4.3.2.4	Attribute 0x64: Parameter Number	34
4.4	Block Sequencer Object (class 0x26)	35
4.4.1	Attribute 0x01: Block	35
4.4.2	Attribute 0x02: Block Execute	35
4.4.3	Attribute 0x03: Current Block	35
4.4.4	Attribute 0x04: Block Fault	35
4.4.5	Attribute 0x05: Block Fault Code	36
4.4.6	Attribute 0x06: Counter	36
4.5	Command Block Object (class 0x27)	37
4.5.1	Block Types	37
4.5.2	Command 0x01 – Modify Attribute	38
4.5.2.1	Attribute 0x01: Block Type	38
4.5.2.2	Attribute 0x02: Block Link #	38
4.5.2.3	Attribute 0x03: Target Class	38
4.5.2.4	Attribute 0x04: Target Instance	38
4.5.2.5	Attribute 0x05: Attribute #	39
4.5.2.6	Attribute 0x06: Attribute Data	39

	Page
4.5.3 Command 0x02 – Wait Until Equals . . . . .	39
4.5.3.1 Attribute 0x01: Block Type . . . . .	39
4.5.3.2 Attribute 0x02: Block Link # . . . . .	39
4.5.3.3 Attribute 0x03: Target Class . . . . .	40
4.5.3.4 Attribute 0x04: Target Instance . . . . .	40
4.5.3.5 Attribute 0x05: Attribute # . . . . .	40
4.5.3.6 Attribute 0x06: Timeout . . . . .	40
4.5.3.7 Attribute 0x07: Compare Data . . . . .	40
4.5.4 Command 0x03 – Greater Than Test . . . . .	41
4.5.4.1 Attribute 0x01: Block Type . . . . .	41
4.5.4.2 Attribute 0x02: Block Link # . . . . .	41
4.5.4.3 Attribute 0x03: Target Class . . . . .	41
4.5.4.4 Attribute 0x04: Target Instance . . . . .	41
4.5.4.5 Attribute 0x05: Attribute # . . . . .	42
4.5.4.6 Attribute 0x06: Compare Link # . . . . .	42
4.5.4.7 Attribute 0x07: Compare Data . . . . .	42
4.5.5 Command 0x04 – Less Than Test . . . . .	43
4.5.5.1 Attribute 0x01: Block Type . . . . .	43
4.5.5.2 Attribute 0x02: Block Link # . . . . .	43
4.5.5.3 Attribute 0x03: Target Class . . . . .	43
4.5.5.4 Attribute 0x04: Target Instance . . . . .	43
4.5.5.5 Attribute 0x05: Attribute # . . . . .	44
4.5.5.6 Attribute 0x06: Compare Link # . . . . .	44
4.5.5.7 Attribute 0x07: Compare Data . . . . .	44
4.5.6 Command 0x05 – Decrement Counter . . . . .	45
4.5.6.1 Attribute 0x01: Block Type . . . . .	45
4.5.6.2 Attribute 0x02: Block Link # . . . . .	45
4.5.7 Command 0x06 – Delay . . . . .	46
4.5.7.1 Attribute 0x01: Block Type . . . . .	46
4.5.7.2 Attribute 0x02: Block Link # . . . . .	46
4.5.7.3 Attribute 0x03: Delay . . . . .	46
4.5.8 Command 0x08 – Motion task . . . . .	47
4.5.8.1 Attribute 0x01: Block Type . . . . .	47
4.5.8.2 Attribute 0x02: Block Link # . . . . .	47
4.5.8.3 Attribute 0x03: Target Position . . . . .	47
4.5.8.4 Attribute 0x04: Target Velocity . . . . .	47
4.5.8.5 Attribute 0x05: Incremental . . . . .	47
4.5.8.6 Attribute 0x64: O_C . . . . .	48
4.5.8.7 Attribute 0x65: O_ACC . . . . .	48
4.5.8.8 Attribute 0x66: O_DEC . . . . .	48
4.5.8.9 Attribute 0x67: O_TAB . . . . .	48
4.5.8.10 Attribute 0x68: O_FT . . . . .	48
4.5.9 Command 0x09 – Jog . . . . .	49
4.5.9.1 Attribute 0x01: Block Type . . . . .	49
4.5.9.2 Attribute 0x02: Block Link # . . . . .	49
4.5.9.3 Attribute 0x03: Target Velocity . . . . .	49
4.6 Digital Input Object (class 0x08) . . . . .	50
4.6.1 Attribute 0x03: Value . . . . .	50
4.7 Digital Output Object (class 0x09) . . . . .	50
4.7.1 Attribute 0x03: Value . . . . .	50
4.8 Analog Input Object (class 0x0A) . . . . .	50
4.8.1 Attribute 0x03: Value . . . . .	50
4.9 Analog Output Object (class 0x0B) . . . . .	51
4.9.1 Attribute 0x03: Value . . . . .	51
4.10 Identity Object (class 0x01) . . . . .	51
4.11 Message Router Object (class 0x02) . . . . .	52
4.12 DeviceNet Object (class 0x03) . . . . .	52
4.13 Connection Object (class 0x05) - Explicit . . . . .	53
4.14 Connection Object (class 0x05) - Polled I/O . . . . .	54

<b>5</b>	<b>Polled I/O messages</b>	
5.1	I/O Command Assemblies	55
5.1.1	Control Bits and Data Fields	56
5.1.2	Running a Stored Sequence through DeviceNet	57
5.1.3	Data Handshaking	58
5.1.4	Command Assembly 0x01 – Target Position	59
5.1.5	Command Assembly 0x02 – Target Velocity	60
5.1.6	Command Assembly 0x03 – Acceleration	61
5.1.7	Command Assembly 0x04 – Deceleration	62
5.1.8	Command Assembly 0x05 – Torque	63
5.2	I/O Response Assemblies	64
5.2.1	Status Bits and Data Fields	64
5.2.2	Response Assembly 0x01 – Actual Position	66
5.2.3	Response Assembly 0x02 – Commanded Position	67
5.2.4	Response Assembly 0x03 – Actual Velocity	68
5.2.5	Response Assembly 0x05 – Torque	69
5.2.6	Response Assembly 0x14 – Command/Response Error	70
<b>6</b>	<b>Appendix</b>	
6.1	DeviceNet PLC Examples	71
6.1.1	Overview	71
6.1.2	Amplifier Setup for the Examples	72
6.1.3	Polled I/O Assemblies	72
6.1.3.1	Sending Command Assemblies - ControlLogix	73
6.1.3.2	Reading Response Assemblies - ControlLogix	74
6.1.3.3	Data Handshaking - ControlLogix	75
6.1.3.4	Sending Command Assemblies - SLC500	76
6.1.3.5	Reading Response Assemblies - SLC500	79
6.1.3.6	Data Handshaking - SLC500	81
6.1.4	Explicit Messages	82
6.1.4.1	Explicit Messages and ControlLogix	83
6.1.4.2	Explicit Messages and SLC500	84
6.1.4.2.1	SLC500 Explicit Message Request Structure	84
6.1.4.2.2	SLC500 Explicit Message Response Structure	85
6.1.4.2.3	SLC500 Explicit Messaging Sequence	85
6.1.4.2.4	SLC500 Explicit Messaging Example Code	86
6.1.5	Example 1: Simple Move	87
6.1.5.1	Serial Command Sequence	88
6.1.5.2	DeviceNet Command Sequence	89
6.1.5.3	ControlLogix program	90
6.1.5.4	SLC500 program	90
6.2	Baud Rate Switch Settings	90
6.3	MAC ID Switch Configuration	90
6.4	Network LED	90
6.5	Listing of DeviceNet Commands	90
6.5.1	Data Types	91
6.5.2	Explicit Messages	91
6.5.3	Polled I/O Messages	94
6.6	Default Input/Output Configuration	95
6.7	Error Messages	96
6.8	Index	97

# 1 General

## 1.1 About this manual

This manual describes the setup, range of functions and software protocol of the SERVOSTAR 300, SERVOSTAR 600 and S700 servo amplifiers with the *DeviceNet™* communication profile. It forms part of the complete documentation for these servo amplifiers.

The installation and setup of the servo amplifier, as well as all standard functions, are described in the corresponding instructions manuals.

### Other parts of the complete documentation for the digital servo amplifier series:

Title	Publisher
Online-Help for Setup Software	Kollmorgen
instructions manual for the servo amplifier	Kollmorgen

### Additional documentation:

Title	Publisher
DeviceNet Specification, Volumes I, II, Release 2.0	ODVA
CAN Specification Version 2.0	CiA e.V.
ISO 11898 ... Controller Area Network (CAN) for high-speed communication	ISO

## 1.2 Target group

This manual addresses personnel with the following qualifications:

Transport : only by personnel with knowledge of handling electrostatically sensitive components.

Unpacking: only by electrically qualified personnel.

Installation : only by electrically qualified personnel.

Setup : only by qualified personnel with extensive knowledge of electrical engineering and drive technology

Programming: Software developers, DeviceNet project-planners

The qualified personnel must know and observe the following standards:

IEC 60364 and IEC 60664

accident prevention regulations

### Qualified Personnel only!

During operation there are deadly hazards, with the possibility of death, severe injury or material damage.

- The user must ensure that the safety instructions in this manual are followed.
- The user must ensure that all personnel responsible for working with the servo amplifier have read and understood the instructions manual.

Training courses are available on request.

## 1.3 Hints for the online edition (PDF format)

### Bookmarks:

Table of contents and index are active bookmarks.

### Table of contents and index in the text:

The lines are active cross references. Click on the desired line and the appropriate page is indicated.

### Page/chapter numbers in the text:

Page/chapter numbers with cross references are active. Click at the page/chapter number to reach the indicated target.

## 1.4 Use as directed

Please observe the chapter "Use as directed" in the instructions manual for the servo amplifier. The DeviceNet interface serves only for the connection of the servo amplifier to a master via the DeviceNet bus.

The servo amplifiers are components that are built into electrical apparatus or machinery, and can only be setup and operated as integral components of such apparatus or machinery.









### NOTE

We only guarantee the conformity of the servo amplifier with the directives listed in the EU Declaration of Conformity, if the components that we specify are used, and the installation regulations are followed.

## 1.5 System requirements

- Servo amplifier SERVOSTAR 600, serial No. 730266001 or higher or a SERVOSTAR 300 or a S700
- DeviceNet expansion card for the servo amplifier
- Master station with a DeviceNet interface (e.g. PC with DeviceNet card)

## 1.6 Symbols used

Symbol	Indication
	Indicates a hazardous situation which, if not avoided, will result in death or serious injury.
	Indicates a hazardous situation which, if not avoided, could result in death or serious injury.
	Indicates a hazardous situation which, if not avoided, could result in minor or moderate injury.
	This is not a safety symbol. Indicates situations which, if not avoided, could result in property damage.
	This is not a safety symbol. This symbol indicates important notes.
	Warning of a danger (general). The type of danger is specified by the warning text next to it.
	Warning of danger from electricity and its effects.
	Warning of danger from automatic start.



## 1.7 Abbreviations used

The abbreviations used in this manual are explained in the table below.

<b>Abbrev.</b>	<b>Meaning</b>
ACC	Acceleration
BOI	Bus Off interrupt
CAN	Controller area network
CCW	Counter clockwise
COS	Change of state
CW	Clockwise
EMC	Electromagnetic compatibility
ISO	International Standardization Organization
LED	Light-emitting diode
LSD	Least significant digit
MAC ID	Media access control identifier
M/S	Master/slave
MSD	Most significant digit
N/A	Not applicable
ODVA	Open DeviceNet Vendor Association
S300	SERVOSTAR 300
S600	SERVOSTAR 600

## 1.8 Application of this manual

Specific examples for individual chapters can be found in the appendix of this manual.

## 1.9 Basic features implemented through DeviceNet

When working with the position controller that is integrated in the digital servo amplifiers, the following functions are available:

### **Setup and general functions:**

- homing, set reference point
- jogging, with a variable speed
- provision of a digital setpoint for speed and torque control

### **Positioning functions:**

- execution of a motion task from the motion block memory of the servo amplifier
- execution of a direct motion task
- absolute trajectory

### **Data transfer functions:**

- transmit a motion task to the motion block memory of the servo amplifier  
A motion task consists of the following elements:
  - » position setpoint (absolute task) or path setpoint (relative task)
  - » speed setpoint
  - » acceleration time, braking time, rate-of-change/jolt limiting (in preparation)
  - » type of motion task (absolute/relative)
  - » number of a following task (with or without pause)
- Transmit a non-motion task to the motion block memory of the servo amplifier

In addition to motion tasks, the following task types can be modified through DeviceNet:

- modify attribute
- wait until parameter = value
- branch if greater than/less than
- decrement counter
- delay
- read a motion task from the motion block memory of the servo amplifier
- read actual values
- read the error register
- read the status register
- read/write configuration and control parameters
- read actual values from analog and digital inputs
- write control values to analog and digital outputs

### **Transmission rate and procedure**

- bus connection and bus medium: CAN-standard ISO 11898 (CAN high-speed)
- transmission rate: 125, 250, 500 kbit/s

## 2 Installation / Setup

### 2.1 Installation



#### **DANGER** High Voltages up to 900V!

Risk of electric shock. Residual charges in the capacitors can still have dangerous levels several minutes after switching off the supply voltage. Power and control connections can still be live, even though the motor is not rotating.

- Install and wire up the equipment only while it is not electrically connected. Make sure that the control cabinet is safely isolated (lock-out, warning signs etc.). The individual supply voltages will not be switched on until setup is carried out.
- Measure the voltage in the intermediate (DC-link) circuit and wait until it has fallen below 50V.



#### **WARNING** Automatic Start!

Risk of death or serious injury for humans working in the machine. Drives with servo amplifiers in fieldbus systems are remote-controlled machines. They can start to move at any time without previous warning.

- Implement appropriate protective measures to ensure that any unintended start-up of the machines cannot result in dangerous situations for personnel or machinery.
- The user is responsible for ensuring that, in the event of a failure of the servo amplifier, the drive is set to a state that is functional safe, for instance with the aid of a safe mechanical brake.
- Software limit-switches are not a substitute for the hardware limit-switches in the machine.

#### **NOTICE**

Install the servo amplifier as described in the S300/S700 or S600 instructions manual. The wiring for the analog setpoint input and the positioning interface is not required.

#### **NOTE**

Because of the internal representation of the position-control parameters, the position controller can only be operated if the final limit speed of the drive at sinusoidal<sup>2</sup> commutation is not more than 7500 rpm. At trapezoidal commutation, the permitted maximum speed is 12000 rpm.

#### **NOTE**

All the data on resolution, step size, positioning accuracy etc. refer to calculatory values. Non-linearities in the mechanism (backlash, flexing, etc.) are not taken into account. If the final limit speed of the motor has to be altered, then all the parameters that were previously entered for position control and motion blocks must be adapted.

### 2.1.1 Install the expansion card

To fit the DeviceNet expansion card into a servo amplifier, proceed as follows:

**NOTE**

- Remove the cover of the option slot (refer to the instructions manual of the servo amplifier).
- Take care that no small items (such as screws) fall into the open option slot.
- Push the expansion card carefully into the guide rails that are provided, without twisting it.
- Press the expansion card firmly into the slot, until the front cover touches the fixing lugs. This ensures that the connectors make good contact.
- Screw the screws on the front cover into the threads in the fixing lugs.

#### 2.1.1.1 Combined Module / Network Status LED

State	LED is	To indicate:
Not powered / not online	<b>off</b>	Device is not online. - The device has not completed the Dup_MAC_ID test yet. - The device may not be powered.
Operational AND online, connected	<b>green</b>	The device is operating in a normal condition and the device is online with connections in the established state. - The device is allocated to a Master
Operational AND online, not connected or Online AND needs configuration	<b>flashing green</b>	The device is operating in a normal condition and the device is online with no connections in the established state. - The device has passed the Dup_MAC_ID test, is online, but has no established connections to other nodes. - This device is not allocated to a master. - Configuration missing, incomplete or incorrect.
Minor fault and/or connection time out	<b>flashing red</b>	Recoverable fault and/or one or more I/O Connections are in the Timed-Out state.
Critical fault or critical link failure	<b>red</b>	- The device has an unrecoverable fault; may need replacing. - Failed communication device. The device has detected an Error that has rendered it incapable of communicating on the network (e.g. Duplicate MAC ID, or Bus-off).

#### 2.1.1.2 Front view

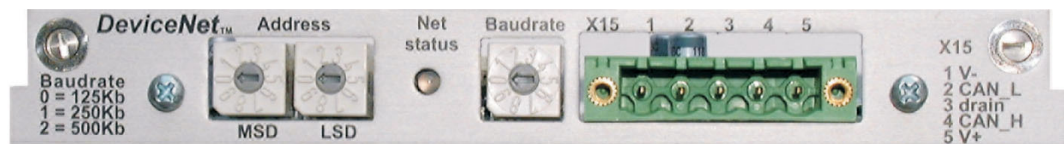

#### 2.1.1.3 Connection technology

Cable selection, cable routing, shielding, bus connector, bus termination and transmission times are all described in the "DeviceNet specification, volumes I, II", published by ODVA

### 2.1.1.4 Bus cable

To meet ISO 898, a bus cable with a characteristic impedance of  $120\ \Omega$  should be used. The maximum usable cable length for reliable communication decreases with increasing transmission speed. As a guide, you can use the following values which we have measured, but they are not to be taken as assured limits.

General characteristic	Specification
Bit rates	125 kbit, 250 kbit, 500 kbit
Distance with larger bus connections	500 meters at 125 kBaud 250 meters at 250 kBaud 100 meters at 500 kBaud
Number of nodes	64
Signal environment	CAN
Modulation	Basic bandwidth
Coupling medium	DC-coupled differential transmit/receive operation
Isolation	500 V (option: optocoupler on the transceiver's node side)
Typical differential input impedance (recessive state)	Shunt C = 5pF Shunt R = 25K $\Omega$ (power on)
Min. differential input impedance (recessive state)	Shunt C = 24pF + 36 pF/m of the permanently attached stub cable Shunt R = 20K $\Omega$
Absolute max. voltage range	-25 V to +18 V (CAN_H, CAN_L) The voltages for CAN_H and CAN_L refer to the ground pin of the transceiver. The voltage is higher than that on the V-terminal by the amount of the forward voltage drop of the Schottky diode. This voltage drop must be < 0.6 V.

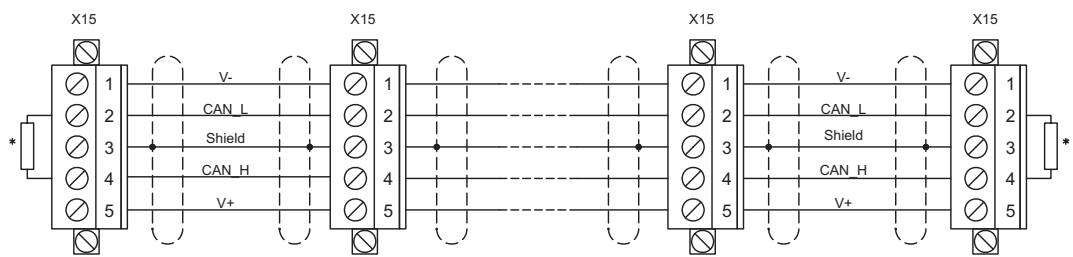

#### Grounding:

The DeviceNet network must only be grounded at one point, to avoid ground loops. The circuitry for the physical layer in all devices are referenced to the V-bus signal. The ground connection is made via the power supply for the bus system. The current flowing between V- and ground must not flow through any device other than the power supply.

#### Bus topology:

The DeviceNet medium utilizes a linear bus topology. Termination resistors are required at each end of the connecting cable. Stub cables are permitted up to a length of 6 meters, so that at least one node can be connected.

#### Termination resistors:

DeviceNet requires a termination **at each end** of the connecting cable.

These resistors must meet the following requirements:  $120\ \Omega$ , 1% metal-film, 1/4 W

#### NOTE

Important: don't install the termination resistors at the end of stub cables, but on both ends of the connecting cable.

**Network Power:**

Power taps for DeviceNet should have the following characteristics:

- Specified ratings for power supply and network currents (24V)
- Fuses or circuit breakers to limit current on the bus if current limiting in the power supply is insufficient.
- 10 ft. maximum cable length from power supply to power tap

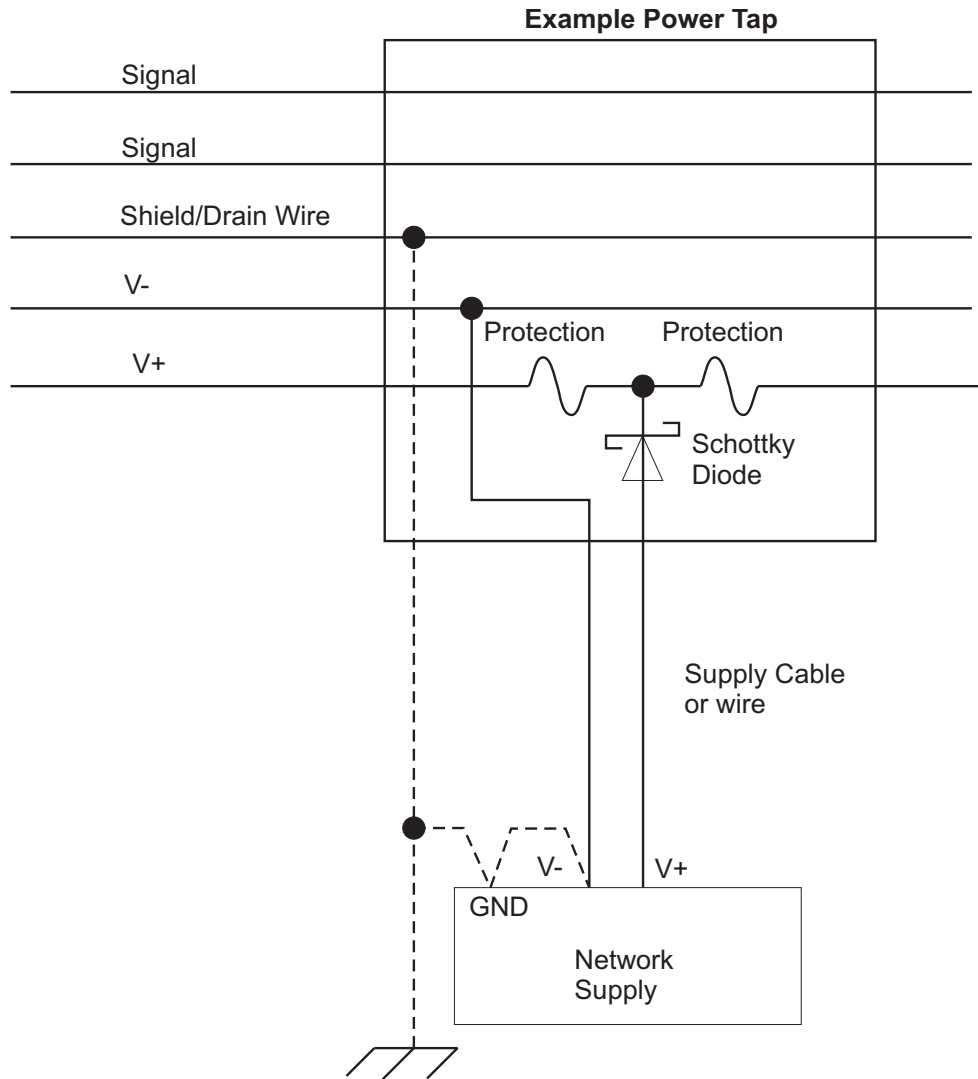

### 2.1.1.5 Connection diagram

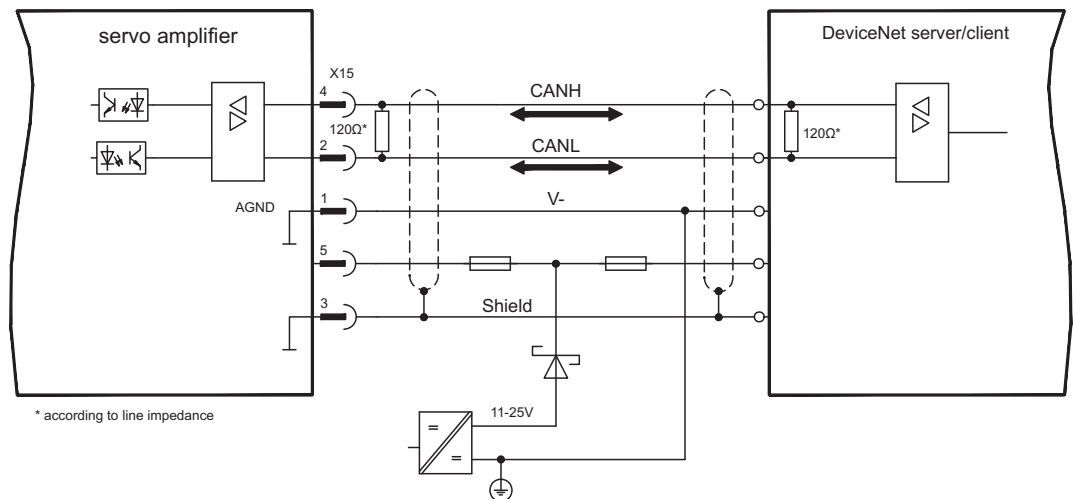

#### NOTE

With S600 terminals AGND and DGND (connector X3) must be joined together !

### 2.1.1.6 Setup of station address

Three different ways to set the station address (device address on the DeviceNet-Bus) for the servo amplifier:

- Set the rotary switches on the front panel of the option card to a value between 0 and 63. Each switch represents one decimal digit. To set the amplifier to address 10, set the MSD (most significant digit) switch to 1 and the LSD (least significant digit) switch to 0.
- Set the rotary switches on the front panel of the expansion card to a value greater than 63. The station address can now be set using the ASCII commands DNMACID x, SAVE, COLDSTART where x is the station address.
- Set the rotary switches on the front panel of the expansion card to a value greater than 63. The station address can now be set through the DeviceNet object (class 0x03, attribute 1). This is typically done through a DeviceNet commissioning tool. All drive parameters will be saved to the non-volatile memory when the value is set. The amplifier must be restarted after modifying the address.

### 2.1.1.7 Setup of transmission rate

Three different ways to set the DeviceNet transmission rate:

- Set the rotary baudrate switch on the front panel of the option card to a value between 0 and 2. 0=125kbit/s, 1=250kbit/s, 2=500kbit/s.
- Set the baudrate switch on the front panel of the expansion card to a value greater than 2. The baud rate can now be set using the terminal commands DNBAUD x, SAVE, COLDSTART where x is 125, 250 or 500.
- Set the baudrate switch on the front panel of the expansion card to a value greater than 2. The baud rate can now be set through the DeviceNet object (class 0x03, attribute 2) to a value between 0 and 2. This is typically done through a DeviceNet commissioning tool. All drive parameters will be saved to the non-volatile memory when the value is set. The amplifier must be restarted after modifying the baud rate.

### 2.1.1.8 Controller setup

Some master controllers request an EDS file (electronic data sheet) for configuring each DeviceNet node. The S300/S700 and S600 EDS file can be found on the Kollmorgen web site and on the product CDROM.

## 2.2 Setup

### 2.2.1 Guide to Setup

#### NOTICE

Only professional personnel with extensive knowledge of control and drive technology are allowed to setup the servo amplifier.

#### Check assembly / installation

Check that all the safety instructions in the instructions manual for the servo amplifier and this manual have been observed and implemented. Check the setting for the station address (see p.15) and baud rate (see p.15).

#### Connect PC, start setup software

Use the amplifier's setup software to set the parameters.

#### Setup the basic functions

Start up the basic functions of the servo amplifier and optimize the current, speed and position controllers. This section is described in the online help of the setup software.

#### Save parameters

When the parameters have been optimized, save them to the servo amplifier.

#### Start bus communication

Requirement: the software protocol must be implemented in the master. Adjust the station address and the transmission rate of the servo amplifier to match the master (see p.15).

#### WARNING: Automatic Start!

Risk of death or serious injury for humans working in the machine. The drive performing unplanned movements during commissioning cannot be ruled out. Make sure that, even if the drive starts to move unintentionally, no danger can result for personnel or machinery. The measures you must take in this regard for your task are based on the risk assessment of the application.

#### Test communication

Connect to the servo amplifier with a master device. Try viewing/modifying a parameter with explicit messaging (Position Controller Object class 0x25, instance 0x01, Target position attribute 0x06 → terminal parameter O\_P).

### 2.2.2

#### Error handling

Several parameters may be used to control DeviceNet error handling.

Bus off events are detected by the amplifier when there is a problem with the DeviceNet network. Default behavior is to automatically reset communications whenever possible. To hold the amplifier in a disconnected state when bus off errors are detected, set the BOI attribute of the DeviceNet object to 0 (class 0x03, instance 1, attribute 3).

By default, the amplifier sets a node-guarding warning n04 when a communication timeout occurs (the timeout behavior is typically controlled automatically by the PLC). To disable the node-guarding warning, set the terminal parameter EXTWD=0.

This service is not supported in the S300/S700.

To view DeviceNet status information for debugging purposes, type DNDUMP in the setup software terminal window.



### 2.2.3 Response to BUSOFF communication faults

The communication fault BUSOFF is directly monitored and signaled by Level 2 (CAN controller). This message may have various causes.

Some examples:

- telegrams are transmitted, although there is no other CAN node connected
- CAN nodes have different transmission rates
- the bus cable is faulty
- faulty cable termination causes reflections on the cable.

The DeviceNet Object (class 0x03, attributes 3 and 4) determines the response to a BUSOFF condition.

This page has been deliberately left blank.

## 3 DeviceNet Overview

The DeviceNet communication profile follows the ODVA standard Position Controller Device profile.

### 3.1 Functionality Chart

DeviceNet™	ODVA Requirements
Device Type	Position Controller
Explicit Peer-to-Peer Messaging	N
I/O Peer-to-Peer Messaging	N
Baud Rates:	125, 250 and 500 kB
Polled Response Time	<10ms
Explicit Response Time	<50ms (except parameter object, <500ms)
Master/Scanner	N
Configuration Consistency Value	N
Faulted Node Recovery	Y
I/O Slave Messaging	
Bit Strobe	N
Polling	Y
Cyclic	N
Change-of-State (COS)	N

### 3.2 Overview of Explicit and Polled I/O (assembly) messages

The servo amplifiers with DeviceNet expansion card support two main types of DeviceNet communication: Explicit Messaging and Polled I/O Messaging.

Typically, Explicit Messaging is used to configure the amplifier and Polled I/O is used to control movement. Most PLC's will support both types of messaging simultaneously. The objects described in sections 3.3 to 3.5 are all accessed through Explicit Messaging. Section 5.1 describes the use of Polled I/O.

Explicit Messages allow you to access a single parameter value at a time. The desired parameter is selected by specifying the class object number, instance number and attribute number in an explicit message. Polled I/O messages combine many control and status bits into 8-byte command and response messages. They are less versatile than explicit messages (only certain parameters are accessible), but several control values may be changes within one message. For this reason, Explicit Messaging is better for configuration and Polled I/O is better for motion control.

Most amplifier configuration is done within the Position Controller Object (class 0x25), which encompasses most parameters necessary for motion control. Modify parameters in this object to set the operational mode (torque, velocity, position) and configure motion. View parameters to read the amplifier status words. Additional amplifier configuration may be done through the Parameter Object (class 0x0F). This is a vendor-defined object which exposes vendor configuration parameters. Any drive parameter with a DPR number (see the `ascii.chm` reference) less than 256 may be accessed through the Parameter Object.

Motion sequences may be pre-programmed into the amplifier through the Command Block Object (class 0x25). These blocks correspond to the SERVOSTAR motion tasking feature. Positioning moves, time delays, and parameter modification blocks may be linked together to create a motion block program that is stored in the amplifier. Once the stored block program has been configured, it may be executed through either the Block Sequencer Object or with the Polled I/O Command Message block number field and start block bit.

Polled I/O is used for most motion control. Control bits in a command message are used to enable the amplifier, do a controlled stop of the motor, initiate motion, and initiate stored motion block programs. Command messages can also set the target position, target velocity, acceleration, deceleration and torque parameters. Status bits in a response message display error states and the general state of the amplifier. Response messages can also display the actual position, commanded position, actual velocity and torque.

See the appendix for examples of actual use.

### 3.3 Motion Objects with Explicit Messaging

The following DeviceNet objects are used to configure an amplifier and control motion.

#### 3.3.1 Object: Parameter

Class Code	0x0F
Instance #	1 to 255
Description	The parameter object gives direct access to amplifier configuration parameters

#### 3.3.2 Object: Position Controller Supervisor

Class Code	0x24
Instance #	1
Description	The position controller supervisor handles errors for the position controller.

#### 3.3.3 Object: Position Controller

Class Code	0x25
Instance #	1
Description	The position controller object is used to set the operating mode (torque, velocity, position), configure motion profiles, and initiate movement.

#### 3.3.4 Object: Block Sequencer

Class Code	0x26
Instance #	1
Description	This object handles the execution of motion blocks or motion block chains

#### 3.3.5 Object: Command Block

Class Code	0x27
Instance #	1 to 255
Description	Each instance of the command block object defines a specific motion block. These blocks can be linked to other blocks to form a motion block chain.

### 3.4 I/O Objects

The following DeviceNet objects are used to control the amplifier's on-board I/O ports.

#### 3.4.1 Object: Discrete Input Point

Class Code	0x08
Instance #	1 to 4
Description	The discrete input point objects give access to the amplifier's four digital inputs.

#### 3.4.2 Object: Discrete Output Point

Class Code	0x09
Instance #	1 to 2
Description	The discrete output point objects give access to the amplifier's two digital outputs.

#### 3.4.3 Object: Analog Input Point

Class Code	0x0A
Instance #	1 to 2
Description	The analog input point objects give access to the amplifier's two analog inputs.

#### 3.4.4 Object: Analog Output Point

Class Code	0x0B
Instance #	1 to 2
Description	The analog output point objects give access to the amplifier's two analog outputs.

## 3.5 Communication Objects

The following DeviceNet objects handle communication between the amplifier and a controller. These are typically not accessed directly by a user's PLC program.

### 3.5.1 Object: Identity

Class Code	0x01
Instance #	1
Description	This object provides identification of any general information about the device. The Identity Object is present in all DeviceNet products

### 3.5.2 Object: Message Router

Class Code	0x02
Instance #	1
Description	This object provides a messaging connection point through which a client may address a service to any object class or instance residing in the physical device.

### 3.5.3 Object: DeviceNet

Class Code	0x03
Instance #	1
Description	This object provides the configuration and status of a DeviceNet port. Each DeviceNet product supports only one DeviceNet object per physical connection to the DeviceNet communication link.

### 3.5.4 Object: Assembly

Class Code	0x04
Instance #	1
Description	This object binds attributes of multiple objects, which allows data to or from each object to be sent or received over a single connection. Assembly objects can be used to bind input or output data. An input produces data on the network and an output consumes data from the network.

### 3.5.5 Object: Explicit Connection

Class Code	0x05
Instance #	1
Description	This object manages the explicit messages.

### 3.5.6 Object: Polled I/O Connection

Class Code	0x07
Instance #	2
Description	This object manages the I/O messages.

### 3.6 Firmware Version

### 3.7 Supported Services

The DeviceNet objects support the following services:

Get\_Single\_Attribute (service code 0x0E)

Set\_Single\_Attribute (service code 0x10)

Reset (service code 0x05, class 0x01, instance 1, attribute 0 or 1, data length = 0)

Save (service code 0x16, class 0x0F, instance 1, attribute 0, data length = 0)

For additional information, we recommend that you review this entire document.

### 3.8 Data Types

The table below describes the data type, number of bits, minimum and maximum Range.

Data Type	Number of Bits	Minimum Value	Maximum Value
Boolean	1	0 (False)	1 (True)
Short Integer	8	-128	127
Unsigned Short Integer	8	0	255
Integer	16	-32768	32767
Unsigned Integer	16	0	65535
Double Integer	32	-2 <sup>31</sup>	2 <sup>31</sup> - 1
Unsigned Double Integer	32	0	2 <sup>32</sup> - 1

### 3.9 Saving to Non-volatile Memory

Amplifier parameters are typically stored in RAM and only stored to non-volatile memory when a SAVE is commanded through Explicit Messaging. A save operation can be initiated over DeviceNet with either of two methods:

- 1) Save service of the Parameter Object. Transmit the following explicit message:
  - Service: 0x16
  - Class: 0x0F
  - Instance: 0x00
  - Attribute: 0x00
  - Data Length: 0
- 2) Save attribute of the Position Controller Object. Transmit the following explicit message:
  - Service: 0x10
  - Class: 0x25
  - Instance: 0x01
  - Attribute: 0x65
  - Data Length: 1
  - Data Value: 1

This page has been deliberately left blank.



## 4 Explicit messages

Typically, Explicit Messages are used to configure the amplifier and setup drive parameters. See section 3.2 for more information.

### 4.1 Position Controller Supervisor Object (class 0x24)

The position controller supervisor handles errors for the position controller.

#### 4.1.1 Error Codes

The amplifier returns one of the following codes when an error is generated while communicating via Explicit Messaging.

Action	Error	Error Code
Set	Attribute Not Settable	0x0E
Set or Get	Attribute Not Supported	0x14
Set or Get	Service Not Supported	0x08
Set or Get	Class Not Supported	0x16
Set	Value is Out of Range	0x09

#### 4.1.1.1 Object State Conflicts – 0x0C

Three conditions could cause the amplifiers to return this error code. To proceed, check and clear the condition.

Condition	Solution
On hard or soft limit and then issuing a command to move in the direction of the limit	Move in opposite direction of the limit
Issuing a command not support in the current mode (i.e., trying to do registration in velocity mode)	Change the mode to fit the application or issue the proper command
Trying to enable a faulted amplifier	Correct the fault before enabling the amplifier.

### 4.1.2 Supervisor Attributes

The following attributes are supported in the Position Controller Supervisor class. The instance number always equals 1 in the class/instance/attribute mappings for the Position Controller Supervisor.

#### 4.1.2.1 Attribute 0x05: General Fault

<b>Description</b>	When active, this indicates that an amplifier-related failure has occurred, (Short Circuit, Over-Voltage, etc.). It is not related to the FAULT input. It is reset when the fault condition is removed.		
<b>Access Rule</b>	Get	<b>Default</b>	None
<b>Data Type</b>	Boolean	<b>Non-Volatile</b>	N/A
<b>Range</b>	1 = Fault condition exists 0 = No fault exists	<b>See also</b>	Fault Code, ERRCODE (ASCII)

**4.1.2.2 Attribute 0x0E: Index Active Level**

This attribute is not supported in the S300/S700

<b>Description</b>	This attribute is used to set the active level of the indexing input.		
<b>Access Rule</b>	Get/Set	<b>Default</b>	None
<b>Data Type</b>	Boolean	<b>Non-Volatile</b>	N/A
<b>Range</b>	0 = Active Low 1 = Active High	<b>See also</b>	N/A

**4.1.2.3 Attribute 0x15: Registration Arm**

This attribute is not supported in the S300/S700

<b>Description</b>	Set the value to 1 to arm the registration input. The values reads 0 when triggered		
<b>Access Rule</b>	Get/Set	<b>Default</b>	None
<b>Data Type</b>	Boolean	<b>Non-Volatile</b>	N/A
<b>Range</b>	0 = registration triggered (Get) 1 = registration armed (Get/Set)	<b>See also</b>	N/A

**4.1.2.4 Attribute 0x16: Registration Input Level**

This attribute is not supported in the S300/S700

<b>Description</b>	This attribute returns the actual value of the registration input.		
<b>Access Rule</b>	Get	<b>Default</b>	None
<b>Data Type</b>	Boolean	<b>Non-Volatile</b>	N/A
<b>Range</b>	0 = Low 1 = High	<b>See also</b>	N/A

**4.1.2.5 Attribute 0x64: Fault Code**

<b>Description</b>	Read the amplifier fault code words.		
<b>Access Rule</b>	Get	<b>Default</b>	None
<b>Data Type</b>	Double Integer	<b>Non-Volatile</b>	No
<b>Range</b>		<b>See also</b>	General Fault, Clear Faults, ERRCODE (ASCII)

**4.1.2.6 Attribute 0x65: Clear Faults**

<b>Description</b>	Set to 1 to clear amplifier faults.		
<b>Access Rule</b>	Set	<b>Default</b>	0
<b>Data Type</b>	Boolean	<b>Non-Volatile</b>	No
<b>Range</b>	0 = Do nothing. 1 = Clear Faults	<b>See also</b>	General Fault, Fault Code, CLRFAULT (ASCII)

## 4.2 Position Controller Object (class 0x25)

The position controller object is used to set the operating mode (torque, velocity, position), configure a direct motion block or jog, and initiate movement.

### 4.2.1 Error Codes

The amplifier returns one of the following error codes when an error is generated while communicating via Explicit Messaging.

Action	Error	Error Code
Set	Attribute Not Settable	0x0E
Set or Get	Attribute Not Supported	0x14
Set or Get	Service Not Supported	0x08
Set or Get	Class Not Supported	0x16
Set	Value is Out of Range	0x09

#### 4.2.1.1 Object State Conflicts – 0x0C

Three conditions could cause the amplifiers to return this error code. To proceed, check and clear the condition.

Condition	Solution
On hard or soft limit and then issuing a command to move in the direction of the limit	Move in opposite direction of the limit
Issuing a command not support in the current mode (i.e. trying to do registration in velocity mode)	Change the mode to fit the application or issue the proper command
Trying to enable a faulted amplifier	Correct the fault before enabling the amplifier.

## 4.2.2 Position controller attributes

The following attributes are supported in the Position Controller class. The instance number always equals 1 in the class/instance/attribute mappings for the Position Controller.

### 4.2.2.1 Attribute 0x01: Number of Attributes

<b>Description</b>	The total number of attributes supported by the unit in the Position Controller Class.		
<b>Access Rule</b>	Get	<b>Default</b>	
<b>Data Type</b>	Unsigned Short Integer	<b>Non-Volatile</b>	N/A
<b>Range</b>	N/A	<b>See also</b>	Attribute List

### 4.2.2.2 Attribute 0x02: Attribute List

<b>Description</b>	Returns an array with a list of the attributes supported by this unit in the Position Controller Class. The length of this list is specified in Number of Attributes.		
<b>Access Rule</b>	Get	<b>Default</b>	
<b>Data Type</b>	Array of Unsigned Short Integer	<b>Non-Volatile</b>	N/A
<b>Range</b>	Array size is defined by Attribute 1.	<b>See also</b>	Number of Attributes

**4.2.2.3 Attribute 0x03: opmode**

<b>Description</b>	This attribute is used to get or set the operating mode. 0=Position (OPMODE 8). 1= velocity (OPMODE 0). 2=Torque (OPMODE 2). This attribute must be set before any move is attempted!		
<b>Access Rule</b>	Get / Set	<b>Default</b>	0
<b>Data Type</b>	Unsigned Short Integer	<b>Non-Volatile</b>	No
<b>Range</b>	0 = Position Mode 1 = Velocity Mode 2 = Torque Mode 3 = Other (read only)	<b>See also</b>	Trajectory Start/Complete, OPMODE (ASCII)

**4.2.2.4 Attribute 0x06: Target Position**

<b>Description</b>	This attribute specifies the target position in counts. Set Start Trajectory=1 (attribute 11) or the Polled I/O Start Trajectory/Load Data bit to initiate the positioning move.		
<b>Access Rule</b>	Get / Set	<b>Default</b>	0
<b>Data Type</b>	Double Integer	<b>Non-Volatile</b>	No
<b>Range</b>	$-2^{31}$ to $2^{31}$	<b>See also</b>	Actual Position, Incremental Mode Flag, Mode, O_P (ASCII)

**4.2.2.5 Attribute 0x07: Target Velocity**

<b>Description</b>	This attribute specifies the target velocity in counts per second. Use target velocity for position opmode and jog velocity (attribute 22) for velocity opmode. Units are determined by the amplifier setup (VUNIT, Position controller attributes 40-41)		
<b>Access Rule</b>	Get / Set	<b>Default</b>	According to setup
<b>Data Type</b>	Double Integer	<b>Non-Volatile</b>	Yes
<b>Range</b>	Set to a positive number	<b>See also</b>	Actual Position, Incremental Mode Flag, Mode, O_V (ASCII)

**4.2.2.6 Attribute 0x08: Acceleration**

<b>Description</b>	This attribute specifies the acceleration for positioning and homing (ACCR) when in position opmode and the acceleration for constant velocity (ACC) when in velocity opmode. Units are determined by the amplifier setup (ACCUNIT, Position controller attributes 40-41) All position moves initiated through a Command Assembly or Command Block Object use this acceleration rate. To set different acceleration rates for multiple motion blocks (tasks) requires the motion block to be setup using the amplifier setup software.		
<b>Access Rule</b>	Get / Set	<b>Default</b>	According to setup
<b>Data Type</b>	Double Integer	<b>Non-Volatile</b>	Yes
<b>Range</b>	Set to a positive number	<b>See also</b>	Deceleration, ACC (ASCII), ACCR (ASCII)

**4.2.2.7 Attribute 0x09: Deceleration**

<b>Description</b>	This attribute specifies the deceleration for positioning and homing (DECR) when in position opmode and the acceleration for constant velocity (DEC) when in velocity opmode. Units are determined by amplifier setup (ACCUNIT, Position controller attributes 40-41) All position moves initiated through a Command Assembly or Command Block Object use this deceleration rate. To set different deceleration rates for multiple motion blocks (tasks) requires the motion block to be setup using the amplifier setup software.		
<b>Access Rule</b>	Get / Set	<b>Default</b>	According to setup
<b>Data Type</b>	Double Integer	<b>Non-Volatile</b>	Yes
<b>Range</b>	Set to a positive number	<b>See also</b>	Acceleration, DEC (ASCII), DECR (ASCII)

#### 4.2.2.8 Attribute 0x0A: Move Type

<b>Description</b>	This bit is used to define the position value as either absolute or incremental in OpMode 8		
<b>Access Rule</b>	Get / Set	<b>Default</b>	1
<b>Data Type</b>	Boolean	<b>Non-Volatile</b>	No
<b>Range</b>	0 = Absolute Position 1 = Incremental Position	<b>See also</b>	Target Position, Trajectory Start/Complete, O_C bit 0 (ASCII)

#### 4.2.2.9 Attribute 0x0B: Trajectory Start/Complete

<b>Description</b>	Set high (1) to start a trajectory move. Reads high (1) while in motion and low (0) when motion is complete		
<b>Access Rule</b>	Get / Set	<b>Default</b>	0
<b>Data Type</b>	Boolean	<b>Non-Volatile</b>	No
<b>Range</b>	0 = Move Complete 1 = Start Trajectory (In Motion)	<b>See also</b>	Hard Stop, Smooth Stop

#### 4.2.2.10 Attribute 0x0C: In Position

<b>Description</b>	This flag, when set, indicates that the motor is within the deadband distance to the target		
<b>Access Rule</b>	Get	<b>Default</b>	1
<b>Data Type</b>	Boolean	<b>Non-Volatile</b>	N/A
<b>Range</b>	0 = Not in position 1 = In position	<b>See also</b>	Trajectory Start/Complete, INPOS (ASCII)

#### 4.2.2.11 Attribute 0x0D: Actual Position

<b>Description</b>	The absolute position value equals the real position in counts. This is set to re-define the actual position.		
<b>Access Rule</b>	Get / Set	<b>Default</b>	0
<b>Data Type</b>	Double Integer	<b>Non-Volatile</b>	No
<b>Range</b>	$-2^{31}$ to $2^{31}$	<b>See also</b>	Incremental Mode Flag, Target Position, PFB (ASCII)

#### 4.2.2.12 Attribute 0x0E: Actual Velocity

<b>Description</b>	This attribute specifies the actual velocity. Units are determined by the amplifier setup (VUNIT, position controller attribute 40-41)		
<b>Access Rule</b>	Get	<b>Default</b>	0
<b>Data Type</b>	Double Integer	<b>Non-Volatile</b>	No
<b>Range</b>	Positive read value	<b>See also</b>	Target Velocity, PV (ASCII)

#### 4.2.2.13 Attribute 0x11: Enable

<b>Description</b>	This flag is used to control the enable output. Clearing this bit sets the enable output inactive and the currently executing motion profile is aborted.		
<b>Access Rule</b>	Get / Set	<b>Default</b>	0
<b>Data Type</b>	Boolean	<b>Non-Volatile</b>	N/A
<b>Range</b>	0 = Disable 1 = Enable	<b>See also</b>	Actual Position, EN (ASCII)

**4.2.2.14 Attribute 0x14: Smooth Stop**

<b>Description</b>	This bit is used to bring the motor to a controlled stop at the currently implemented deceleration rate.		
<b>Access Rule</b>	Get / Set	<b>Default</b>	0
<b>Data Type</b>	Boolean	<b>Non-Volatile</b>	No
<b>Range</b>	0 = No Action 1 = Perform Smooth Stop	<b>See also</b>	Acceleration, Deceleration, Hard Stop, Trajectory Start/Complete, STOP (ASCII)

**4.2.2.15 Attribute 0x15: Hard Stop**

<b>Description</b>	This bit is used to bring the motor to an immediate stop		
<b>Access Rule</b>	Get / Set	<b>Default</b>	0
<b>Data Type</b>	Boolean	<b>Non-Volatile</b>	No
<b>Range</b>	0 = No Action 1 = Perform Hard Stop	<b>See also</b>	Smooth Stop, Trajectory Start/Complete, DECSTOP (ASCII)

**4.2.2.16 Attribute 0x16: Jog Velocity**

<b>Description</b>	This attribute is used to set the target velocity in velocity mode. The Direction attribute is used to select the direction of the velocity move. The Trajectory Start attribute is used to begin motion. Units are determined by the amplifier setup (VUNIT, position controller attributes 40-41)		
<b>Access Rule</b>	Get / Set	<b>Default</b>	0
<b>Data Type</b>	Double Integer	<b>Non-Volatile</b>	Yes
<b>Range</b>	Positive	<b>See also</b>	Mode (velocity), Direction, Trajectory Start/Complete, J (ASCII)

**4.2.2.17 Attribute 0x17: Direction**

<b>Description</b>	Set this bit to control the direction of the motor in velocity mode. Read this bit to get the actual direction of motion.		
<b>Access Rule</b>	Get / Set	<b>Default</b>	1
<b>Data Type</b>	Boolean	<b>Non-Volatile</b>	No
<b>Range</b>	0 = Negative Direction 1 = Positive Direction	<b>See also</b>	Mode (velocity), Reference Direction, J (ASCII)

**4.2.2.18 Attribute 0x18: Reference direction**

This attribute is not supported in the S300/S700

<b>Description</b>	Defines positive direction (when viewed from the motor shaft side)		
<b>Access Rule</b>	Get / Set	<b>Default</b>	0
<b>Data Type</b>	Boolean	<b>Non-Volatile</b>	Yes
<b>Range</b>	0 = Positive Clockwise Motion 1 = Positive Counter-Clockwise Motion	<b>See also</b>	Direction, DIR (ASCII)

#### 4.2.2.19 Attribute 0x19: Torque

<b>Description</b>	Set a new torque command in torque mode or read the current torque command. The Trajectory Start attribute is used to begin motion		
<b>Access Rule</b>	Get / Set	<b>Default</b>	0
<b>Data Type</b>	Double Integer	<b>Non-Volatile</b>	No
<b>Range</b>	-3280 to 3280 (3280 = peak torque)	<b>See also</b>	Mode (torque), Trajectory Start, T (ASCII)

#### 4.2.2.20 Attribute 0x28: Feedback resolution

<b>Description</b>	<p>Number of actual position feedback counts (or amplifier internal units) in one revolution (PGEARO). The resolution is generally 1048576 counts/turn for PRBASE = 20 or 65536 counts/turn for PRBASE = 16. The Motor Resolution and Feedback Resolution attributes are used to define the desired resolution of user units for position in terms of internal units. Velocity and acceleration units may be defined in terms of position units, depending on the values of VUNIT and ACCUNIT.</p> <p>Position[internal units] = Position[user units] * FeedbackResolution / MotorResolution</p> <p>Example: if PRBASE=20 for 2^20 bits per revolution in the internal position units, set Feedback Resolution = 1048576.</p> <p>Now for user units of 1000 counts/rev, set Motor Resolution = 1000.</p>		
<b>Access Rule</b>	Get / Set	<b>Default</b>	1048576
<b>Data Type</b>	Double Integer	<b>Non-Volatile</b>	Yes
<b>Range</b>	positive	<b>See also</b>	Motor resolution, PGEARO (ASCII), VUNIT (ASCII), ACCUNIT (ASCII), PRBASE (ASCII)

#### 4.2.2.21 Attribute 0x29: Motor resolution

<b>Description</b>	<p>Number of user-defined steps in one revolution of the motor (PGEARI). The Motor Resolution and Feedback Resolution attributes are used to define the desired resolution of user units for position in terms of internal units. Velocity and acceleration units may be defined in terms of position units, depending on the values of VUNIT and ACCUNIT.</p> <p>Position[internal units] = Position[user units] * FeedbackResolution / MotorResolution</p> <p>Example: if PRBASE=20 for 2^20 bits per revolution in the internal position units, set Feedback Resolution = 1048576.</p> <p>Now for user units of 1000 counts/rev, set Motor Resolution = 1000.</p>		
<b>Access Rule</b>	Get / Set	<b>Default</b>	10000
<b>Data Type</b>	Double Integer	<b>Non-Volatile</b>	Yes
<b>Range</b>	positive	<b>See also</b>	Feedback resolution, PGEARI (ASCII), VUNIT (ASCII), ACCUNIT (ASCII), PRBASE (ASCII)

#### 4.2.2.22 Attribute 0x65: Save Parameters

<b>Description</b>	Set to 1 to save drive parameters to non-volatile storage.		
<b>Access Rule</b>	Set	<b>Default</b>	0
<b>Data Type</b>	Boolean	<b>Non-Volatile</b>	No
<b>Range</b>	0 = Do nothing. 1 = Save parameters.	<b>See also</b>	SAVE (ASCII)

#### 4.2.2.23 Attribute 0x66: Amplifier Status

This attribute is not supported in the S300/S700. Read DRVSTAT using the Parameter Object (class 0x0F) Non-Volatile 0x2D, Attribute 0x01.

<b>Description</b>	Read the amplifier status words. See the ASCII reference for a description of the status bits (DRVSTAT).		
<b>Access Rule</b>	Get	<b>Default</b>	
<b>Data Type</b>	Double Integer	<b>Non-Volatile</b>	No
<b>Range</b>		<b>See also</b>	DRVSTAT (ASCII)

#### 4.2.2.24 Attribute 0x67: Trajectory Status

<b>Description</b>	Read the amplifier trajectory status words. See the ASCII reference for a description of the status bits (TRJSTAT).		
<b>Access Rule</b>	Get	<b>Default</b>	
<b>Data Type</b>	Double Integer	<b>Non-Volatile</b>	No
<b>Range</b>		<b>See also</b>	TRJSTAT (ASCII)



### 4.3 Parameter Object (class 0x0F)

Most drive parameters can be read and or written through the Parameter Object. This includes many drive parameters also available through the Position Controller (class 0x25), Block Sequencer (class 0x26), and Command Block Object (class 0x27). The Parameter Object, which gives direct access to amplifier configuration parameters is a vendor-defined object.

In an explicit message to the parameter object, the instance number corresponds to the DPR number for the desired parameter. This DPR number may be found in the `ascii.chm` command reference. Only parameters 1-254 can be directly accessed with the instance number, since the instance field is only 1 byte. Instance 255 is a special instance which means 'use the Parameter Number attribute'. See section 4.3.2.4 for documentation for accessing parameters 255 and higher.

The data length for Set Value commands can be determined from the 'Data Type Bus/DPR' field of `ascii.chm`. Float types are scaled by 1000 to get an integer value.

Amplifier commands such as Jog, Home, and Save are executed by sending a Set Value command with a data length of 1 and a value of 1. Reading the value or setting the value to 0 will not execute the process.

For example, send the following explicit message to initiate homing (Move Home = MH, DPR/instance = 141):

[class=0x0F, instance=141, attribute=0x01, data length=1, data value=0x01].

#### 4.3.1 Error Codes

The amplifier returns one of the following error codes when an error is generated while communicating via Explicit Messaging.

Action	Error	Error Code
Set	Attribute Not Settable	0x0E
Set or Get	Attribute Not Supported	0x14
Set or Get	Service Not Supported	0x08
Set or Get	Class Not Supported	0x16
Set	Value is Out of Range	0x09

#### 4.3.2 Parameter Attributes

These are attributes supported by the unit in the Parameter Object Class.

##### 4.3.2.1 Attribute 0x01: Parameter Value

<b>Description</b>	Directly access the parameter value. Check the command reference for the data type and read/write access rule. Float types are multiplied by 1000 to get an integer value. Set the value to 1 to execute an amplifier process (eg Move Home).		
<b>Access Rule</b>	depends on the parameter and is given in <code>ascii.chm</code> in the Type field.	<b>Default</b>	
<b>Data Type</b>	depends on the parameter and is given in <code>ascii.chm</code> in the Format field. The byte length is given by Data Length parameter.	<b>Non-Volatile</b>	
<b>Range</b>		<b>See also</b>	Descriptor, Data Length, <code>ascii.chm</code>

##### 4.3.2.2 Attribute 0x04: Descriptor

<b>Description</b>	The descriptor will be 0x00 for read/write parameters and 0x10 for read-only parameters		
<b>Access Rule</b>	Get	<b>Default</b>	
<b>Data Type</b>	Unsigned Short Integer	<b>Non-Volatile</b>	
<b>Range</b>		<b>See also</b>	

**4.3.2.3 Attribute 0x06: Data Length**

<b>Description</b>	Length of the parameter in bytes		
<b>Access Rule</b>	Get	<b>Default</b>	
<b>Data Type</b>	Unsigned Short Integer	<b>Non-Volatile</b>	
<b>Range</b>		<b>See also</b>	

**4.3.2.4 Attribute 0x64: Parameter Number**

<b>Description</b>	Parameter number to access with instance 255. To access parameters with a DPR number greater than 254, load the desired DPR number into the Parameter Number attribute, then use the Parameter Object instance 255 to access the parameter. Note that this is a class attribute, so use instance 0 when setting the Parameter Number.		
<b>Access Rule</b>	Set	<b>Default</b>	0
<b>Data Type</b>	Unsigned Integer	<b>Non-Volatile</b>	No
<b>Range</b>	1 to max DPR number in use	<b>See also</b>	

Example: read the value of VLIM, DPR #290. Set the Parameter Number = 290 (service=Set, class=0x0F, instance=0x00, attribute=0x64, value=0x0122). Read the value (service=Get, class=0x0F, instance=0xFF, attribute=0x01).

## 4.4 Block Sequencer Object (class 0x26)

This object handles the execution of Motion Blocks or Motion Block chains. Motion sequences may be pre-programmed into the amplifier through the Command Block Object (class 0x27). These blocks correspond to the servo amplifier motion tasking feature. Positioning moves, time delays, and parameter modification blocks may be linked together to create a motion block program that is stored in the amplifier. Once the stored block program has been configured, it may be executed through either the Block Sequencer Object or with the Polled I/O Command Message block number field and start block bit.

### 4.4.1 Attribute 0x01: Block

<b>Description</b>	This value defines the starting Command Block instance number to execute. The block number corresponds to the number in a MOVE [block number] command		
<b>Access Rule</b>	Get / Set	<b>Default</b>	N/A
<b>Data Type</b>	Unsigned Short Integer	<b>Non-Volatile</b>	N/A
<b>Range</b>	1 to 255	<b>See also</b>	Block Execute, MOVE (ASCII)

### 4.4.2 Attribute 0x02: Block Execute

<b>Description</b>	Executes the starting command block defined by Attribute 1. This corresponds to a MOVE command		
<b>Access Rule</b>	Get / Set	<b>Default</b>	0
<b>Data Type</b>	Boolean	<b>Non-Volatile</b>	N/A
<b>Range</b>	0 = Clear or Complete 1 = Execute Block (set) / Block Executing (get)	<b>See also</b>	Block, Block Fault, MOVE (ASCII)

### 4.4.3 Attribute 0x03: Current Block

<b>Description</b>	This attribute returns the command block instance number of the currently-executing block. Reads 0 while homing.		
<b>Access Rule</b>	Get	<b>Default</b>	N/A
<b>Data Type</b>	Unsigned Short Integer	<b>Non-Volatile</b>	N/A
<b>Range</b>	1 to 255	<b>See also</b>	Block, Block Execute, TASKNUM (ASCII)

### 4.4.4 Attribute 0x04: Block Fault

<b>Description</b>	Set when a block error occurs. When a block fault error occurs, block execution stops. This bit is reset when the block fault code (5) is read.		
<b>Access Rule</b>	Get	<b>Default</b>	0
<b>Data Type</b>	Boolean	<b>Non-Volatile</b>	
<b>Range</b>	0 = No Block Faults 1 = Block Fault Occurred	<b>See also</b>	Block Execute, Block Fault Code

#### 4.4.5 Attribute 0x05: Block Fault Code

<b>Description</b>	This attribute defines the specific block fault. Read this value to clear the fault		
<b>Access Rule</b>	Get	<b>Default</b>	N/A
<b>Data Type</b>	Boolean	<b>Non-Volatile</b>	N/A
<b>Range</b>	0 = No Fault 1 = Invalid or Empty Block 2 = Command Time-out (Wait Equals) 3 = Execution Fault	<b>See also</b>	Block Fault

#### 4.4.6 Attribute 0x06: Counter

This attribute is not supported in the S300/S700

<b>Description</b>	This value is used as a global counter for motion tasks. To view from a serial terminal, type M LOOPCNT.		
<b>Access Rule</b>	Get / Set	<b>Default</b>	0
<b>Data Type</b>	Double Integer	<b>Non-Volatile</b>	No
<b>Range</b>	Positive	<b>See also</b>	Decrement Counter Command (Block Object)

## 4.5 Command Block Object (class 0x27)

Motion sequences may be pre-programmed into the amplifier through the Command Block Object. These blocks are stored in the amplifier as Motion Tasks and can be viewed using the amplifier's Setup software. Positioning moves, time delays, and parameter modification blocks may be linked together to create a motion block program that is stored in the amplifier. Once the stored block program has been configured, it may be executed through either the Block Sequencer Object or with the Polled I/O Command Message block number field and start block bit.

Each instance of the Command Block class defines a specific command or a specific Motion Task that is stored in the amplifier. For example, Command Block instance #4 corresponds to motion task #4 and can be viewed from the Position->Position Data->Motion Task Table screen in the setup software or with an ORDER 1 command from the serial terminal.

The first two attributes of the Command Block Object are always the same: Block Type and Block Link Number. Begin defining each block (motion task) by setting attribute 1 the Block type (1 to 9). Attributes 3-7 of each block or motion task are defined by the value of Block Command. For this reason, they cannot be set until the Block Type has been set. See the appendix for an example of setting up a motion block program with DeviceNet.

### 4.5.1 Block Types

The block type is determined by the value of the first attribute. The other attributes are defined by the Block Type; for this reason, the Block Type must be set before the other attribute values.

Block Command	Other Attributes	Description
1 = Modify Attribute	Link, Class, Instance, Attribute, Data	Set the value of any DeviceNet accessible attribute.
2 = Wait for Attribute Value	Link, Class, Instance, Attribute, Timeout, Data	Delay until a DeviceNet accessible attribute equals a desired value.
3 = Greater Than Test	Link, Class, Instance, Attribute, Alternate Link, Data	Test the value of a DeviceNet accessible attribute and branch to an alternate block if the attribute value is greater than the test value.
4 = Less Than Test	Link, Class, Instance, Attribute, Alternate Link, Data	Test the value of a DeviceNet accessible attribute and branch to an alternate block if the attribute value is less than the test value.
5 = Decrement Counter	Link	This block decrements the global counter in the Command Block Sequencer object.
6 = Delay	Link, Time	This block causes the sequencer to delay for a given number of milliseconds before continuing with the next block.
8 = Initiate Trajectory	Link, Target Position, Target Velocity, Incremental	Execute a positioning move.
9 = Velocity Change	Target Velocity	Execute a velocity profile.

**NOTE**

Only command 0x08 Motion Task is supported in the S300/S700.

## 4.5.2 Command 0x01 – Modify Attribute

This command is not supported in the S300/S700

### 4.5.2.1 Attribute 0x01: Block Type

<b>Description</b>	0x01 = Modify Attribute. The Block Command specifies the command to be performed by the task block. The value is stored in a different format in the low byte of O_C2 (see Appendix for more information).		
<b>Access Rule</b>	Get / Set	<b>Default</b>	N/A
<b>Data Type</b>	Unsigned Short Integer	<b>Instance</b>	Block instances 1-180 are non-volatile (stored in ROM). Block instances 181-255 are volatile (stored in RAM).
<b>Range</b>	0x01 = Command 01	<b>See also</b>	Command Map Appendix, O_C2 (ASCII), ORDER (ASCII)

### 4.5.2.2 Attribute 0x02: Block Link #

<b>Description</b>	This attribute provides a link to the next block instance to execute. When this block is complete, the link block is executed. Set this attribute to 0 to stop motion after this task is complete – a next task will not be executed. The value is stored in O_FN.		
<b>Access Rule</b>	Get / Set	<b>Default</b>	0
<b>Data Type</b>	Unsigned Short Integer	<b>Instance</b>	Block instances 1-180 are non-volatile (stored in ROM). Block instances 181-255 are volatile (stored in RAM).
<b>Range</b>	0 to 255	<b>See also</b>	O_FN (ASCII), ORDER (ASCII)

### 4.5.2.3 Attribute 0x03: Target Class

<b>Description</b>	This attribute defines the class number of the object to be accessed. The value is stored in the upper byte of O_ACC1.		
<b>Access Rule</b>	Get / Set	<b>Default</b>	
<b>Data Type</b>	Double Integer	<b>Instance</b>	Block instances 1-180 are non-volatile (stored in ROM). Block instances 181-255 are volatile (stored in RAM).
<b>Range</b>		<b>See also</b>	Position Controller Class, Parameter Class, ORDER (ASCII)

### 4.5.2.4 Attribute 0x04: Target Instance

<b>Description</b>	This attribute defines the instance number of the object to be accessed. The value is stored in O_DEC1.		
<b>Access Rule</b>	Get / Set	<b>Default</b>	
<b>Data Type</b>	Double Integer	<b>Instance</b>	Block instances 1-180 are non-volatile (stored in ROM). Block instances 181-255 are volatile (stored in RAM).
<b>Range</b>		<b>See also</b>	Sections in this document describing class attributes, ORDER (ASCII)

#### 4.5.2.5 Attribute 0x05: Attribute #

<b>Description</b>	This attribute defines the attribute number of the object to be accessed. The value is stored in the lower byte of O_ACC1. The attribute referenced by the class, instance and attribute numbers in the command must be settable for this command to execute.		
<b>Access Rule</b>	Get / Set	<b>Default</b>	
<b>Data Type</b>	Double Integer	<b>Instance</b>	Block instances 1-180 are non-volatile (stored in ROM). Block instances 181-255 are volatile (stored in RAM).
<b>Range</b>		<b>See also</b>	Sections in this document describing class attributes, ORDER (ASCII)

#### 4.5.2.6 Attribute 0x06: Attribute Data

<b>Description</b>	This is the new attribute data. The value is stored in O_P.		
<b>Access Rule</b>	Get / Set	<b>Default</b>	
<b>Data Type</b>	Double Integer	<b>Instance</b>	Block instances 1-180 are non-volatile (stored in ROM). Block instances 181-255 are volatile (stored in RAM).
<b>Range</b>		<b>See also</b>	ORDER (ASCII)

#### 4.5.3 Command 0x02 – Wait Until Equals

This command is not supported in the S300/S700  
This command is used to wait until an attribute equals a desired value.

##### 4.5.3.1 Attribute 0x01: Block Type

<b>Description</b>	0x02 = Wait Until Equals. The Block Command specifies the command to be performed by the task block. The value is stored in a different format in the low byte of O_C2 (see the Command Map Appendix for more information).		
<b>Access Rule</b>	Get / Set	<b>Default</b>	N/A
<b>Data Type</b>	Unsigned Short Integer	<b>Instance</b>	Block instances 1-180 are non-volatile (stored in ROM). Block instances 181-255 are volatile (stored in RAM).
<b>Range</b>	0x02 = Command 02	<b>See also</b>	Command Map Appendix, O_C2 (ASCII), ORDER (ASCII)

##### 4.5.3.2 Attribute 0x02: Block Link #

<b>Description</b>	This attribute provides a link to the next block instance to execute. When this block is complete, the link block is executed. Set this attribute to 0 to stop motion after this task is complete – a next task will not be executed. The value is stored in O_FN.		
<b>Access Rule</b>	Get / Set	<b>Default</b>	0
<b>Data Type</b>	Unsigned Short Integer	<b>Instance</b>	Block instances 1-180 are non-volatile (stored in ROM). Block instances 181-255 are volatile (stored in RAM).
<b>Range</b>	0 to 255	<b>See also</b>	O_FN (ASCII), ORDER (ASCII)

### 4.5.3.3 Attribute 0x03: Target Class

<b>Description</b>	This attribute defines the class number of the object to be accessed. The value is stored in the upper byte of O_ACC1.		
<b>Access Rule</b>	Get / Set	<b>Default</b>	
<b>Data Type</b>	Double Integer	<b>Instance</b>	Block instances 1-180 are non-volatile (stored in ROM). Block instances 181-255 are volatile (stored in RAM).
<b>Range</b>		<b>See also</b>	Position Controller Class, Parameter Class, ORDER (ASCII)

### 4.5.3.4 Attribute 0x04: Target Instance

<b>Description</b>	This attribute defines the instance number of the object to be accessed. The value is stored in O_DEC1.		
<b>Access Rule</b>	Get / Set	<b>Default</b>	
<b>Data Type</b>	Double Integer	<b>Instance</b>	Block instances 1-180 are non-volatile (stored in ROM). Block instances 181-255 are volatile (stored in RAM).
<b>Range</b>		<b>See also</b>	ORDER (ASCII)

### 4.5.3.5 Attribute 0x05: Attribute #

<b>Description</b>	This attribute defines the attribute number of the object to be accessed. The value is stored in the lower byte of O_ACC1. The attribute referenced by the class, instance and attribute numbers in the command must be settable for this command to execute.		
<b>Access Rule</b>	Get / Set	<b>Default</b>	
<b>Data Type</b>	Double Integer	<b>Instance</b>	Block instances 1-180 are non-volatile (stored in ROM). Block instances 181-255 are volatile (stored in RAM).
<b>Range</b>		<b>See also</b>	Sections in this document describing class attributes, ORDER (ASCII)

### 4.5.3.6 Attribute 0x06: Timeout

<b>Description</b>	Maximum time in ms to wait for the parameter to equal the desired value. A fault is issued if the timer expires. If set to 0, motion tasking will wait without faulting. Stored in O_FT		
<b>Access Rule</b>	Get / Set	<b>Default</b>	
<b>Data Type</b>	Double Integer	<b>Instance</b>	Block instances 1-180 are non-volatile (stored in ROM). Block instances 181-255 are volatile (stored in RAM).
<b>Range</b>		<b>See also</b>	O_FT (ASCII), ORDER (ASCII)

### 4.5.3.7 Attribute 0x07: Compare Data

<b>Description</b>	The attribute is compared to this value. If they are equal, motion will continue; otherwise, the amplifier will wait. The value is stored in O_P.		
<b>Access Rule</b>	Get / Set	<b>Default</b>	
<b>Data Type</b>	Dependent on Attribute #	<b>Instance</b>	Block instances 1-180 are non-volatile (stored in ROM). Block instances 181-255 are volatile (stored in RAM).
<b>Range</b>		<b>See also</b>	ORDER (ASCII)



#### 4.5.4 Command 0x03 – Greater Than Test

This command is not supported in the S300/S700

This command is used for conditional linking or branching in a linked chain of commands. When the block is executed, it will test the value of a DeviceNet accessible attribute and branch to an alternate block if the attribute value is greater than the test value.

##### 4.5.4.1 Attribute 0x01: Block Type

<b>Description</b>	0x03 = Greater Than Test. The Block Command specifies the command to be performed by the task block. The value is stored in a different format in the low byte of O_C2 (see the Command Map Appendix for more information).		
<b>Access Rule</b>	Get / Set	<b>Default</b>	N/A
<b>Data Type</b>	Unsigned Short Integer	<b>Instance</b>	Block instances 1-180 are non-volatile (stored in ROM). Block instances 181-255 are volatile (stored in RAM)
<b>Range</b>	0x03= Command 03	<b>See also</b>	Command Map Appendix, O_C2 (ASCII), ORDER (ASCII)

##### 4.5.4.2 Attribute 0x02: Block Link #

<b>Description</b>	Description This attribute provides a link to the next block instance to execute. When this block is complete, the link block is executed. Set this attribute to 0 to stop motion after this task is complete – a next task will not be executed. The value is stored in O_FN.		
<b>Access Rule</b>	Get / Set	<b>Default</b>	0
<b>Data Type</b>	Unsigned Short Integer	<b>Instance</b>	Block instances 1-180 are non-volatile (stored in ROM). Block instances 181-255 are volatile (stored in RAM)
<b>Range</b>	0 to 255	<b>See also</b>	O_FN (ASCII), ORDER (ASCII)

##### 4.5.4.3 Attribute 0x03: Target Class

<b>Description</b>	This attribute defines the class number of the object to be accessed. The value is stored in the upper byte of O_ACC1.		
<b>Access Rule</b>	Get / Set	<b>Default</b>	
<b>Data Type</b>	Double Integer	<b>Instance</b>	Block instances 1-180 are non-volatile (stored in ROM). Block instances 181-255 are volatile (stored in RAM)
<b>Range</b>		<b>See also</b>	Position Controller Class, Parameter Class, ORDER (ASCII)

##### 4.5.4.4 Attribute 0x04: Target Instance

<b>Description</b>	This attribute defines the instance number of the object to be accessed. The value is stored in O_DEC1.		
<b>Access Rule</b>	Get / Set	<b>Default</b>	
<b>Data Type</b>	Double Integer	<b>Instance</b>	Block instances 1-180 are non-volatile (stored in ROM). Block instances 181-255 are volatile (stored in RAM)
<b>Range</b>		<b>See also</b>	ORDER (ASCII)

**4.5.4.5 Attribute 0x05: Attribute #**

<b>Description</b>	This attribute defines the attribute number of the object to be accessed. The value is stored in the lower byte of O_ACC1. The attribute referenced by the class, instance and attribute numbers in the command must be settable for this command to execute.		
<b>Access Rule</b>	Get / Set	<b>Default</b>	
<b>Data Type</b>	Double Integer	<b>Instance</b>	Block instances 1-180 are non-volatile (stored in ROM). Block instances 181-255 are volatile (stored in RAM)
<b>Range</b>		<b>See also</b>	Sections in this document describing class attributes, ORDER (ASCII)

**4.5.4.6 Attribute 0x06: Compare Link #**

<b>Description</b>	If the attribute value is greater than the test value, branch to the block specified in this attribute instead of the block specified in attribute 2. The value is stored in O_DEC2.		
<b>Access Rule</b>	Get / Set	<b>Default</b>	
<b>Data Type</b>	Double Integer	<b>Instance</b>	Block instances 1-180 are non-volatile (stored in ROM). Block instances 181-255 are volatile (stored in RAM)
<b>Range</b>	1 to 255	<b>See also</b>	ORDER (ASCII)

**4.5.4.7 Attribute 0x07: Compare Data**

<b>Description</b>	This attribute is the comparison data for the conditional test. If the test attribute's value is greater than the compare data, the normal link (Attribute 2) is ignored and the next block executed is the compare link block (Attribute 6).		
<b>Access Rule</b>	Get / Set	<b>Default</b>	
<b>Data Type</b>	Dependent on Attribute #	<b>Instance</b>	Block instances 1-180 are non-volatile (stored in ROM). Block instances 181-255 are volatile (stored in RAM)
<b>Range</b>		<b>See also</b>	ORDER (ASCII)

### 4.5.5 Command 0x04 – Less Than Test

This command is not supported in the S300/S700

This command is used for conditional linking or branching in a linked chain of commands. When the block is executed, it will test the value of a DeviceNet accessible attribute and branch to an alternate block if the attribute value is less than the test value.

#### 4.5.5.1 Attribute 0x01: Block Type

<b>Description</b>	0x04 = Less Than Test. The Block Command specifies the command to be performed by the task block. The value is stored in a different format in the low byte of O_C2 (see the Command Map Appendix for more information).		
<b>Access Rule</b>	Get / Set	<b>Default</b>	N/A
<b>Data Type</b>	Unsigned Short Integer	<b>Instance</b>	Block instances 1-180 are non-volatile (stored in ROM). Block instances 181-255 are volatile (stored in RAM)
<b>Range</b>	0x04 = Command 04	<b>See also</b>	Command Map Appendix, O_C2 (ASCII), ORDER (ASCII)

#### 4.5.5.2 Attribute 0x02: Block Link #

<b>Description</b>	This attribute provides a link to the next block instance to execute. When this block is complete, the link block is executed. This value must be non-zero for the delay command. The value is stored in O_FN		
<b>Access Rule</b>	Get / Set	<b>Default</b>	
<b>Data Type</b>	Unsigned Short Integer	<b>Instance</b>	Block instances 1-180 are non-volatile (stored in ROM). Block instances 181-255 are volatile (stored in RAM)
<b>Range</b>	1 to 255	<b>See also</b>	O_FN (ASCII), ORDER (ASCII)

#### 4.5.5.3 Attribute 0x03: Target Class

<b>Description</b>	This attribute defines the class number of the object to be accessed. The value is stored in the upper byte of O_ACC1.		
<b>Access Rule</b>	Get / Set	<b>Default</b>	
<b>Data Type</b>	Double Integer	<b>Instance</b>	Block instances 1-180 are non-volatile (stored in ROM). Block instances 181-255 are volatile (stored in RAM)
<b>Range</b>		<b>See also</b>	Position Controller Class, Parameter Class, ORDER (ASCII)

#### 4.5.5.4 Attribute 0x04: Target Instance

<b>Description</b>	This attribute defines the instance number of the object to be accessed. The value is stored in O_DEC1.		
<b>Access Rule</b>	Get / Set	<b>Default</b>	
<b>Data Type</b>	Double Integer	<b>Instance</b>	Block instances 1-180 are non-volatile (stored in ROM). Block instances 181-255 are volatile (stored in RAM)
<b>Range</b>		<b>See also</b>	ORDER (ASCII)

**4.5.5.5 Attribute 0x05: Attribute #**

<b>Description</b>	This attribute defines the attribute number of the object to be accessed. The value is stored in the lower byte of O_ACC1. The attribute referenced by the class, instance and attribute numbers in the command must be settable for this command to execute.		
<b>Access Rule</b>	Get / Set	<b>Default</b>	
<b>Data Type</b>	Double Integer	<b>Instance</b>	Block instances 1-180 are non-volatile (stored in ROM). Block instances 181-255 are volatile (stored in RAM)
<b>Range</b>		<b>See also</b>	Sections in this document describing class attributes, ORDER (ASCII)

**4.5.5.6 Attribute 0x06: Compare Link #**

<b>Description</b>	If the attribute value is less than the test value, branch to the block specified in this attribute instead of the block specified in attribute 2. The value is stored in O_DEC2.		
<b>Access Rule</b>	Get / Set	<b>Default</b>	
<b>Data Type</b>	Double Integer	<b>Instance</b>	Block instances 1-180 are non-volatile (stored in ROM). Block instances 181-255 are volatile (stored in RAM)
<b>Range</b>	1 to 255	<b>See also</b>	ORDER (ASCII)

**4.5.5.7 Attribute 0x07: Compare Data**

<b>Description</b>	This attribute is the comparison data for the conditional test. If the test attribute's value is less than the compare data, the normal link (Attribute 2) is ignored and the next block executed is the compare link block (Attribute 6).		
<b>Access Rule</b>	Get / Set	<b>Default</b>	
<b>Data Type</b>	Dependent on Attribute #	<b>Instance</b>	Block instances 1-180 are non-volatile (stored in ROM). Block instances 181-255 are volatile (stored in RAM)
<b>Range</b>		<b>See also</b>	ORDER (ASCII)

#### 4.5.6 Command 0x05 – Decrement Counter

This command is not supported in the S300/S700

This command is used to decrement the global counter (Block Sequencer class 0x26, instance 1, attribute 6). Combine this block with Modify Attribute and Less Than Test blocks to implement loops and branches within your block program.

##### 4.5.6.1 Attribute 0x01: Block Type

<b>Description</b>	0x05 = Decrement Counter. The Block Command specifies the command to be performed by the task block. The value is stored in a different format in the low byte of O_C2 (see the Command Map Appendix for more information).		
<b>Access Rule</b>	Get / Set	<b>Default</b>	N/A
<b>Data Type</b>	Unsigned Short Integer	<b>Instance</b>	Block instances 1-180 are non-volatile (stored in ROM). Block instances 181-255 are volatile (stored in RAM)
<b>Range</b>	0x05 = Command 05	<b>See also</b>	Command Map Appendix, O_C2 (ASCII), ORDER (ASCII)

##### 4.5.6.2 Attribute 0x02: Block Link #

<b>Description</b>	This attribute provides a link to the next block instance to execute. When this block is complete, the link block is executed. Set this attribute to 0 to stop motion after this task is complete – a next task will not be executed. The value is stored in O_FN.		
<b>Access Rule</b>	Get / Set	<b>Default</b>	0
<b>Data Type</b>	Unsigned Short Integer	<b>Instance</b>	Block instances 1-180 are non-volatile (stored in ROM). Block instances 181-255 are volatile (stored in RAM)
<b>Range</b>	0 to 255	<b>See also</b>	O_FN (ASCII), ORDER (ASCII)

## 4.5.7 Command 0x06 – Delay

This command is not supported in the S300/S700.  
This command is used to delay a linked chain of commands.

### 4.5.7.1 Attribute 0x01: Block Type

<b>Description</b>	0x06 = Delay. The Block Command specifies the command to be performed by the task block. The value is stored in the low byte of O_C2 (see the Command Map Appendix for more information).		
<b>Access Rule</b>	Get / Set	<b>Default</b>	N/A
<b>Data Type</b>	Unsigned Short Integer	<b>Instance</b>	Block instances 1-180 are non-volatile (stored in ROM). Block instances 181-255 are volatile (stored in RAM)
<b>Range</b>	0x06 = Command 06	<b>See also</b>	Command Map Appendix, O_C2 (ASCII), ORDER (ASCII)

### 4.5.7.2 Attribute 0x02: Block Link #

<b>Description</b>	This attribute provides a link to the next block instance to execute. When this block is complete, the link block is executed. Set this attribute to 0 to stop motion after this task is complete – a next task will not be executed. The value is stored in O_FN.		
<b>Access Rule</b>	Get / Set	<b>Default</b>	0
<b>Data Type</b>	Unsigned Short Integer	<b>Instance</b>	Block instances 1-180 are non-volatile (stored in ROM). Block instances 181-255 are volatile (stored in RAM)
<b>Range</b>	0 to 255	<b>See also</b>	O_FN (ASCII), ORDER (ASCII)

### 4.5.7.3 Attribute 0x03: Delay

<b>Description</b>	This attribute sets the delay in milliseconds. The value is stored in O_FT.		
<b>Access Rule</b>	Get / Set	<b>Default</b>	
<b>Data Type</b>	Double Integer	<b>Instance</b>	Block instances 1-180 are non-volatile (stored in ROM). Block instances 181-255 are volatile (stored in RAM)
<b>Range</b>		<b>See also</b>	O_FT (ASCII), ORDER (ASCII)

#### 4.5.8 Command 0x08 – Motion task

This command is used to initiate a positioning move and wait for completion. The acceleration and deceleration are stored in O\_ACC1 and O\_DEC1 of ORDER 0. Bits 0x800 in O\_C and 0x100 in O\_C2 of the task are set to 1 so that the acceleration and deceleration are taken from task 0 rather than the current task. This allows global values for DeviceNet motion blocks.

##### 4.5.8.1 Attribute 0x01: Block Type

<b>Description</b>	0x08 = Initiate Trajectory. The Block Command specifies the command to be performed by the task block. The value is stored in a different format in the low byte of O_C2 (see the Command Map Appendix for more information)		
<b>Access Rule</b>	Get / Set	<b>Default</b>	N/A
<b>Data Type</b>	Unsigned Short Integer	<b>Instance</b>	Block instances 1-180 are non-volatile (stored in ROM). Block instances 181-255 are volatile (stored in RAM)
<b>Range</b>	0x08 = Command 08	<b>See also</b>	Command Map Appendix, O_C2 (ASCII), ORDER (ASCII)

##### 4.5.8.2 Attribute 0x02: Block Link #

<b>Description</b>	This attribute provides a link to the next block instance to execute. When this block is complete, the link block is executed. Set this attribute to 0 to stop motion after this task is complete – a next task will not be executed. The value is stored in O_FN.		
<b>Access Rule</b>	Get / Set	<b>Default</b>	0
<b>Data Type</b>	Unsigned Short Integer	<b>Instance</b>	Block instances 1-180 are non-volatile (stored in ROM). Block instances 181-255 are volatile (stored in RAM)
<b>Range</b>	0 to 255	<b>See also</b>	O_FT (ASCII), ORDER (ASCII)

##### 4.5.8.3 Attribute 0x03: Target Position

<b>Description</b>	This attribute defines the target profile position in position units. The value is stored in O_P		
<b>Access Rule</b>	Get / Set	<b>Default</b>	
<b>Data Type</b>	Double Integer	<b>Instance</b>	Block instances 1-180 are non-volatile (stored in ROM). Block instances 181-255 are volatile (stored in RAM)
<b>Range</b>		<b>See also</b>	O_P (ASCII), ORDER (ASCII)

##### 4.5.8.4 Attribute 0x04: Target Velocity

<b>Description</b>	This attribute defines the target profile velocity in profile units per second. The value is stored in O_V.		
<b>Access Rule</b>	Get / Set	<b>Default</b>	
<b>Data Type</b>	Double Integer	<b>Instance</b>	Block instances 1-180 are non-volatile (stored in ROM). Block instances 181-255 are volatile (stored in RAM)
<b>Range</b>		<b>See also</b>	O_V (ASCII), ORDER (ASCII)

##### 4.5.8.5 Attribute 0x05: Incremental

<b>Description</b>	This flag defines if the motion is incremental or absolute. The value is stored in bit 0 of O_C		
<b>Access Rule</b>	Get / Set	<b>Default</b>	0
<b>Data Type</b>	Boolean	<b>Instance</b>	Block instances 1-180 are non-volatile (stored in ROM). Block instances 181-255 are volatile (stored in RAM)
<b>Range</b>	0 = Absolute Position 1 = Incremental Position	<b>See also</b>	O_C (ASCII), ORDER (ASCII)

**4.5.8.6 Attribute 0x64: O\_C**

This attribute is not supported in the S600.

<b>Description</b>	This attribute provides direct access to the O_C ORDER parameter. O_C is also automatically modified when the Block Command (Command Block Object, Attribute 0x01) is set to Command 0x08 Motion Task.		
<b>Access Rule</b>	Get / Set	<b>Default</b>	N/A
<b>Data Type</b>	Unsigned Long Integer	<b>Instance</b>	Block instances 1-180 are non-volatile (stored in ROM). Block instances 181-255 are volatile (stored in RAM)
<b>Range</b>		<b>See also</b>	O_C (ASCII), ORDER (ASCII)

**4.5.8.7 Attribute 0x65: O\_ACC**

This attribute is not supported in the S600.

<b>Description</b>	This attribute provides direct access to the O_ACC ORDER parameter. O_ACC is also automatically modified when the Block Command (Command Block Object, Attribute 0x01) is set to Command 0x08 Motion Task.		
<b>Access Rule</b>	Get / Set	<b>Default</b>	N/A
<b>Data Type</b>	Unsigned Long Integer	<b>Instance</b>	Block instances 1-180 are non-volatile (stored in ROM). Block instances 181-255 are volatile (stored in RAM)
<b>Range</b>		<b>See also</b>	O_ACC (ASCII), ORDER (ASCII)

**4.5.8.8 Attribute 0x66: O\_DEC**

This attribute is not supported in the S600.

<b>Description</b>	This attribute provides direct access to the O_DEC ORDER parameter. O_DEC is also automatically modified when the Block Command (Command Block Object, Attribute 0x01) is set to Command 0x08 Motion Task.		
<b>Access Rule</b>	Get / Set	<b>Default</b>	N/A
<b>Data Type</b>	Unsigned Long Integer	<b>Instance</b>	Block instances 1-180 are non-volatile (stored in ROM). Block instances 181-255 are volatile (stored in RAM)
<b>Range</b>		<b>See also</b>	O_DEC (ASCII), ORDER (ASCII)

**4.5.8.9 Attribute 0x67: O\_TAB**

This attribute is not supported in the S600.

<b>Description</b>	This attribute provides direct access to the O_TAB ORDER parameter. O_TAB is also automatically modified when the Block Command (Command Block Object, Attribute 0x01) is set to Command 0x08 Motion Task.		
<b>Access Rule</b>	Get / Set	<b>Default</b>	N/A
<b>Data Type</b>	Unsigned Long Integer	<b>Instance</b>	Block instances 1-180 are non-volatile (stored in ROM). Block instances 181-255 are volatile (stored in RAM)
<b>Range</b>		<b>See also</b>	O_TAB (ASCII), ORDER (ASCII)

**4.5.8.10 Attribute 0x68: O\_FT**

This attribute is not supported in the S600.

<b>Description</b>	This attribute provides direct access to the O_FT ORDER parameter. O_FT is also automatically modified when the Block Command (Command Block Object, Attribute 0x01) is set to Command 0x08 Motion Task.		
<b>Access Rule</b>	Get / Set	<b>Default</b>	N/A
<b>Data Type</b>	Unsigned Long Integer	<b>Instance</b>	Block instances 1-180 are non-volatile (stored in ROM). Block instances 181-255 are volatile (stored in RAM)
<b>Range</b>		<b>See also</b>	O_FT (ASCII), ORDER (ASCII)



### 4.5.9 Command 0x09 – Jog

This command is not supported in the S300/S700.

This command is used to execute a velocity profile. Since the move is of infinite duration (until stopped), the block cannot be linked to a following task.

#### 4.5.9.1 Attribute 0x01: Block Type

<b>Description</b>	0x09 = Velocity Change. The Block Command specifies the command to be performed by the task block. The value is stored in a different format in the low byte of O_C2 (see the Command Map Appendix for more information)		
<b>Access Rule</b>	Get / Set	<b>Default</b>	N/A
<b>Data Type</b>	Unsigned Short Integer	<b>Instance</b>	Block instances 1-180 are non-volatile (stored in ROM). Block instances 181-255 are volatile (stored in RAM)
<b>Range</b>	0x09 = Command 09	<b>See also</b>	Command Map Appendix, O_C2 (ASCII), ORDER (ASCII)

#### 4.5.9.2 Attribute 0x02: Block Link #

<b>Description</b>	This attribute typically provides a link to the next block instance to execute. Since a Velocity Change command cannot have a next block, this attribute should not be set		
<b>Access Rule</b>	Get / Set	<b>Default</b>	0
<b>Data Type</b>	Unsigned Short Integer	<b>Instance</b>	Block instances 1-180 are non-volatile (stored in ROM). Block instances 181-255 are volatile (stored in RAM)
<b>Range</b>	0	<b>See also</b>	O_FT (ASCII), ORDER (ASCII)

#### 4.5.9.3 Attribute 0x03: Target Velocity

<b>Description</b>	This attribute defines the target profile velocity in profile units per second. The value is stored in O_V		
<b>Access Rule</b>	Get / Set	<b>Default</b>	
<b>Data Type</b>	Double Integer	<b>Instance</b>	Block instances 1-180 are non-volatile (stored in ROM). Block instances 181-255 are volatile (stored in RAM)
<b>Range</b>		<b>See also</b>	O_V (ASCII), ORDER (ASCII)

## 4.6 Digital Input Object (class 0x08)

The digital input objects access the amplifier's four digital inputs. Instances 1-4 correspond to digital inputs 1-4.

### 4.6.1 Attribute 0x03: Value

<b>Description</b>	This attribute will read 1 when the digital input is high. Instances 1-4 correspond to digital inputs 1-4.		
<b>Access Rule</b>	Get	<b>Default</b>	none
<b>Data Type</b>	Boolean	<b>Non-Volatile</b>	N/A
<b>Range</b>	0 = Input is inactive 1 = Input is active	<b>See also</b>	IN1 - IN4 (ASCII)

## 4.7 Digital Output Object (class 0x09)

The digital output objects access the amplifier's two digital outputs. Instances 1-2 correspond to digital outputs 1-2. To configure the amplifier for DeviceNet control of the digital outputs, set O1MODE=23 and O2MODE=23.

### 4.7.1 Attribute 0x03: Value

<b>Description</b>	Set this attribute to 1 to set the digital output high. Instances 1-2 correspond to digital outputs		
<b>Access Rule</b>	Set	<b>Default</b>	none
<b>Data Type</b>	Boolean	<b>Non-Volatile</b>	N/A
<b>Range</b>	0 = set output low 1 = set output high	<b>See also</b>	O1MODE / O2MODE (ASCII), O1 / O2 (ASCII)

## 4.8 Analog Input Object (class 0x0A)

The analog input objects access the amplifier's two analog inputs. Instances 1-2 correspond to analog inputs 1-2.

### 4.8.1 Attribute 0x03: Value

<b>Description</b>	Voltage on the analog input, in millivolts. Instances 1-2 correspond to analog inputs 1-2.		
<b>Access Rule</b>	Get	<b>Default</b>	none
<b>Data Type</b>	Integer	<b>Non-Volatile</b>	N/A
<b>Range</b>	-10000 to 10000	<b>See also</b>	ANIN1 / ANIN2 (ASCII)

## 4.9 Analog Output Object (class 0x0B)

This object is not supported in the S300/S700.

The analog output objects access the amplifier's two analog outputs. Instances 1-2 correspond to analog outputs 1-2. To configure the amplifier for DeviceNet control of the analog outputs, set ANOUT1=6 and ANOUT2=6.

### 4.9.1 Attribute 0x03: Value

<b>Description</b>	Set to the desired output voltage in millivolts. To configure the amplifier for DeviceNet control of the analog outputs, set ANOUT1=6 and ANOUT2=6. The value is stored in AN1TRIG / AN2TRIG.		
<b>Access Rule</b>	Set	<b>Default</b>	none
<b>Data Type</b>	Integer	<b>Non-Volatile</b>	N/A
<b>Range</b>	-1000 to 10000	<b>See also</b>	ANOUT1 / ANOUT2 (ASCII), AN1TRIG / AN2TRIG (ASCII)

## 4.10 Identity Object (class 0x01)

Identity Object 0x01						
Object Class	ID	Description	Get	Set	Value Limits	
Attributes      Open	1	Revision				
	2	Max instance				
	X   None Supported	3	Number of Instances			
		4	Optional attributes list			
		5	Optional services list			
		6	Max Id of class attributes			
		7	Max Id of instance attributes			
		<b>DeviceNet Services</b>	<b>Parameter Options</b>			
Services		Get_Attributes_All				
		Reset				
X   None Supported		Get_Attribute_Single				
		Find_Next_Object_instance				
Object Instance	ID	Description	Get	Set	Value Limits	
Attributes      Open	1	Vendor	X		=(452)	
	2	Device type	X		=(16)	
	3	Product code	X		=(3)	
	4	Revision	X		=(1.1)	
	5	Status (bits supported)	X			
	6	Serial number	X			
	7	Product name	X		SERVOSTAR	
	8	State				
	9	Config. Consistency Value				
	10	Heartbeat Interval				
		<b>DeviceNet Services</b>	<b>Parameter Options</b>			
Services		Get_Attributes_All				
	X	Reset		0,1		
	X	Get_Attribute_Single				
		Set_Attribute_Single				

4.11 Message Router Object (class 0x02)

Message Router Object 0x02						
Object Class	ID	Description	Get	Set	Value Limits	
Attributes Open	1	Revision				
	2	Max instance				
	X None Supported	3	Number of Instances			
		4	Optional attributes list			
		5	Optional services list			
		6	Max Id of class attributes			
		7	Max Id of instance attributes			
<b>DeviceNet Services</b>			<b>Parameter Options</b>			
Services		Get_Attributes_All				
X None Supported		Get_Attribute_Single				
Object Instance	ID	Description	Get	Set	Value Limits	
Attributes Open	1	Object list				
	2	Maximum connections supported				
	X None Supported	3	Number of active connections			
		4	Active connections list			
<b>DeviceNet Services</b>			<b>Parameter Options</b>			
Services		Get_Attributes_All				
		Get_Attribute_Single				
X None Supported		Set_Attribute_Single				

4.12 DeviceNet Object (class 0x03)

DeviceNet Object 0x03						
Object Class	ID	Description	Get	Set	Value Limits	
Attributes Open	1	Revision	X			
	2	Max instance				
	None Supported	3	Number of Instances			
		4	Optional attributes list			
		5	Optional services list			
		6	Max Id of class attributes			
		7	Max Id of instance attributes			
<b>DeviceNet Services</b>			<b>Parameter Options</b>			
Services	X	Get_Attribute_Single				
None Supported						
Object Instance	ID	Description	Get	Set	Value Limits	
Attributes Open	1	MAC ID	X			
	2	Baud rate	X			
	None Supported	3	BOI	X	X	
		4	Bus-off counter	X	X	
		5	Allocation information	X		
		6	MAC ID switch changed			
		7	Baud rate switch changed			
		8	MAC ID switch value	X		
		9	Baud rate switch value	X		
<b>DeviceNet Services</b>			<b>Parameter Options</b>			
Services	X	Get_Attributes_All				
	X	Set_Attribute_Single				
None Supported	X	Allocate M/S connection set				
	X	Release M/S connection set				

## 4.13 Connection Object (class 0x05) - Explicit

Connection Object 0x05							
Object Class	ID	Description	Get	Set	Value Limits		
Attributes	Open	1	Revision				
		2	Max instance				
X None Supported		3	Number of Instances				
		4	Optional attributes list				
		5	Optional services list				
		6	Max Id of class attributes				
		7	Max Id of instance attributes				
		<b>DeviceNet Services</b>	<b>Parameter Options</b>				
Services			Reset				
			Create				
			Delete				
X None Supported			Get_Attribute_Single				
			Find_Next_Object_instance				
<b>Object Instance</b>	<b>Connection type</b>		<b>Max. connection instances</b>				
	<b>M/S Explicit message</b>		<b>1 Server</b>	<b>Client</b>	<b>1 Total</b>		
	Production trigger(s)		Cyclic	COS	App. trig.		
	Transport type(s)		Server	X	Client		
	Transport class(es)			2	3 X		
Attributes	ID	Description	Get	Set	Value Limits		
Attributes	Open	1	State	X			
		2	Instance type	X			
		3	Transport class trigger	X			
		4	Produced connection ID	X			
		5	Consumed connection ID	X			
		6	Initial comm. characteristics	X			
		7	Produced connection size	X			
		8	Consumed connection size	X			
		9	Expected packet rate	X	X		
		12	Watchdog time-out action	X	X		
		13	Produced connection path len	X			
		14	Produced connection path	X			
		15	Consumed connection path len	X			
		16	Consumed connection path	X			
		17	Production inhibit time				
				<b>DeviceNet Services</b>	<b>Parameter Options</b>		
		Services	X		Reset		
	Delete						
	Apply_attributes						
	Get_Attribute_Single						
	Set_Attribute_Single						

4.14 Connection Object (class 0x05) - Polled I/O

Connection Object 0x05							
Object Class	ID	Description	Get	Set	Value Limits		
Attributes      Open	1	Revision					
	2	Max instance					
	X    None Supported	3	Number of Instances				
		4	Optional attributes list				
		5	Optional services list				
		6	Max Id of class attributes				
		7	Max Id of instance attributes				
		DeviceNet Services	Parameter Options				
Services	X	Reset					
		Create					
		Delete					
X    None Supported		Get_Attribute_Single					
		Find_Next_Object_instance					
Object Instance	Connection type		Max. connection instances				
	M/S poll		1 Server	Client		1 Total	
	Production trigger(s)		Cyclic	X	COS	App. trig.	
	Transport type(s)		Server	X		Client	
	Transport class(es)				2	X	3
Attributes	ID	Description	Get	Set	Value Limits		
Attributes      Open	1	State	X				
	2	Instance type	X				
		3	Transport class trigger	X			
		4	Produced connection ID	X			
		5	Consumed connection ID	X			
		6	Initial comm. characteristics	X			
		7	Produced connection size	X			
		8	Consumed connection size	X			
		9	Expected packet rate	X	X		
		12	Watchdog time-out action	X	X		
		13	Produced connection path len	X			
		14	Produced connection path	X			
		15	Consumed connection path len	X			
		16	Consumed connection path	X			
		17	Production inhibit time				
			DeviceNet Services	Parameter Options			
	Services	X	Reset				
		Delete					
		Apply_attributes					
	X	Get_Attribute_Single					
	X	Set_Attribute_Single					

## 5 Polled I/O messages

Typically, Polled I/O (Assembly) Messages are used for real-time data and motion control. See section 3.2 for more information.

### 5.1 I/O Command Assemblies

Polled I/O Messaging is a method of transmitting a group of control bits and a data command and receiving back a group of status bits and a data value response. This method of communication is preferred, as explicit messaging can transmit only a single value at a time. Polled I/O and Explicit Messaging may be used simultaneously for communications between the controller and the amplifier. In this section, the format of each Command Assembly is defined and examples of each are provided.

Command assemblies contain control bits which are defined the same for each type of command. In addition to the control bits, a command assembly may be used to send one data command at a time (target position, target velocity, acceleration, deceleration or torque). The command type is specified in the Command Assembly Type field.

The amplifier will respond to each Command Assembly it receives by transmitting a Response Assembly. The response assembly has status bits which are defined the same for each type of response. In addition to status bits, a response assembly can transmit one data value at a time (actual position, commanded position, actual velocity, actual torque or error code). The response type is specified in the Response Assembly Type field of the command assembly. A command assembly may contain both a Command Assembly Type and a Response Assembly Type to transmit a command and request a response in the same assembly.

**NOTE**

The command is ignored unless a valid command assembly type is specified in byte 2 (valid command assembly types are 0 through 5).

Data outside the range of the attribute will result in an Error Response Assembly. This applies to all Command Assemblies, except Assembly 5 (torque).

The amplifier must be homed before motion is begun in position mode. Failure to home the amplifier will result in an amplifier alarm that must be cleared before amplifier operation can continue.

### 5.1.1 Control Bits and Data Fields

Byte	Bit 7	Bit 6	Bit 5	Bit 4	Bit 3	Bit 2	Bit 1	Bit 0
0	Enable	Reg Arm	Hard Stop	Smooth Stop	Dir	Relative	Start Block	Load / Start
1	Block Number							
2	Command Axis = 001			Command Assembly Type				
3	Response Axis = 001			Response Assembly Type				
4	Data Low Byte							
5	Data Low Middle Byte							
6	Data High Middle Byte							
7	Data High Byte							

**Enable** Setting this bit enables the amplifier. See also Enable (class 0x25 Position Controller, attribute 0x11).

**Registration Arm** Arm the registration input. This bit is not supported in the S300/S700.

**Hard Stop** Setting this bit causes the amplifier to stop immediately (without decelerating). See also Hard Stop (class 0x25 Position Controller, attribute 0x15).

**Smooth Stop** Setting this bit causes the amplifier to decelerate to a stop. See also Smooth Stop (class 0x25 Position Controller, attribute 0x14).

**CAUTION:** To stop motion, issue either HARD STOP or SMOOTH STOP only. Changing either one of these bits at the same time as the Start Trajectory bit causes indeterminate action from the controller.

**Direction** This bit is used only in velocity opmode. Positive direction=1 and negative direction=0. See also Direction (class 0x25 Position Controller, attribute 0x17).

**Relative** This bit is used in only in position mode. This bit indicates whether the position specified in bytes 4 through 7 of the Command Assembly 1 – Target Position, is absolute (0) or relative (1). See also Incremental Position Flag (class 0x25 Position Controller Object, attribute 0x0A).

**Start Block** Executes programs previously generated and stored in the amplifier. To execute a motion program previously generated through either the Command Block Object or Graphical Motion Tasking (PC software), put the starting block number in Block Number and transition this bit high (1). The Load/Start flag must be zero (0) while transitioning Start Block. See also Block Execute (class 0x26 Block Sequencer, attribute 0x02).

**CAUTION:** Setting Start Block high (1) and issuing a transition from 0 to 1 for Load/Start simultaneously causes indeterminate action.

**Load/Start** This bit is used for data handshaking between the controller and amplifier. To transmit a command to the amplifier, set the Command Type and load data into the data fields, then toggle Load/Start high. The amplifier will accept data only when Load/Start transitions from 0 to 1. If the command type matches the operating mode (Target Position in position mode, Target Velocity in velocity mode, Torque in torque mode), the amplifier will start motion when the data is loaded. When the data has been loaded successfully, the amplifier will set the Load Complete response flag high.



<b>Block Number</b>	Used with Start Block to run a Command Block (motion task) sequence previously defined in the amplifier. This field indicates the block instance to begin executing when Start Block transitions from 0 to 1. The Block Number field is used only to execute Command Blocks (motion tasks), not to modify them. To modify Command Blocks, send Explicit Messages to the Command Block Object. See also Block (class 0x26 Block Sequencer, attribute 0x01).
<b>Command Axis</b>	The amplifier supports only one axis, so this value must always be 1. Any other value will cause a COMMAND_AXIS_INVALID error response.
<b>Response Axis</b>	The amplifier supports only one axis, so this value must always be 1. Any other value will cause a RESPONSE_AXIS_INVALID error response.
<b>Command Assembly Type</b>	The target position, velocity, acceleration, deceleration and torque may be modified with a command assembly. Set the command type to the desired command number (described in following sections). Set the command type to zero (0) to give no command in the assembly.
<b>Response Assembly Type</b>	Set the response type in the command assembly to determine what data will be returned in the response assembly. The actual position, target position, actual velocity, and actual torque are available. See Polled I/O Response Assembly for more information. Set the response type to zero (0) to not request a data response (a response assembly with valid status bits will still be returned).
<b>Data Bytes</b>	Load data for the desired command type into the data fields, least significant byte first.

### 5.1.2

#### Running a Stored Sequence through DeviceNet

A motion tasking sequence may be setup in the Amplifier program (Graphical Motion Tasking) or through DeviceNet (see the Command Block object) and then executed later through DeviceNet. See the setup software online help for instructions on creating a motion tasking sequence with the PC software.

To execute a motion block sequence, set Block Number equal to the index of the block to begin executing and transition the Start Block bit high. Enable must be high and the stop and Load/Start bits must be low. The Appendix contains examples of creating stored sequences with the Command Block Object and executing them with Command Assemblies.

Byte	Bit 7	Bit 6	Bit 5	Bit 4	Bit 3	Bit 2	Bit 1	Bit 0
0	Enable	Reg Arm	Hard Stop	Smooth Stop	Dir (Vel Mode)	Incremental	Start Block	Trajectory Start
1	Block Number							
2	0	0	1	0	Input Command Assembly Type (0000)			
3	0	0	1	0	Output Response Assembly Type			
4	0							
5	0							
6	0							
7	0							

To stop an executing sequence, set the Smooth Stop or Hard Stop bit high.

### 5.1.3 Data Handshaking

Data handshaking is used to transmit data commands with Polled I/O Messaging. To transmit a command to the amplifier, set the Command Type and load data into the data fields, then toggle the Load/Start bit high. The amplifier will accept data only when Load/Start transitions from 0 to 1. If the data is loaded successfully, the amplifier will set the Load Complete response flag high. Load Complete will be cleared by the amplifier after Load/Start is cleared by the controller.

If the data does not load successfully due to an error in the command assembly, the amplifier will load an error response into the response assembly (Response Type = 0x14, byte 4 = Error Code, byte 5 = Additional Code, bytes 6-7 echo command assembly bytes 2-3). See Polled I/O Response Assembly 0x14 – Command/Response Error for more information.

Polled I/O Handshaking Sequence	Example
1. Controller loads a valid Command Type and data into the command assembly with Load/Start low (0).	Load a Target Position command of 1000. C: 0x80 0x00 0x21 0x20 0xE8 0x03 0x00 0x00 Enable=1, Load/Start=0, Command Axis=1, Command Type=1, Response Axis=1, Response Type=0 (none), Data=1000
2. Amplifier clears the Load Complete flag in the response assembly when Load/Start is low in the command assembly.	Respond with status flags. No command yet. R: 0x84 0x00 0x00 0x20 0x00 0x00 0x00 0x00 Enabled=1, In Position=1, Load Complete=0, Response Axis=1, Response Type=0 (none), Data=0
3. Controller checks that the Load Complete flag in the response assembly is low to ensure that the amplifier is ready to receive data. Controller sets the Load Data flag in the command assembly.	Set the Load Data flag. C: 0x81 0x00 0x21 0x20 0xE8 0x03 0x00 0x00 Enable=1, Load/Start=1, Command Axis=1, Command Type=1, Response Axis=1, Data=1000
4. Amplifier sees the Load/Start flag transition high and attempts to execute the command specified in the Command Type field on the data in the Data bytes. If successful, the amplifier sets the Load Complete flag. If the command fails or the command assembly is invalid, the amplifier will set Response Type to Error and load error information in the response assembly Data fields. If the command matches the operating mode (e.g. Target Position in positioning mode), the amplifier will start motion.	If no error, execute the requested command R: 0x81 0x00 0x80 0x20 0x00 0x00 0x00 0x00 Enabled=1, In Motion=1, Load Complete=1, Response Axis=1, Response Type=0 (none), Data=0 If there was an error (e.g. data out of range): R: 0x80 0x00 0x00 0x34 0x09 0xFF 0x21 0x20 Enabled=1, Load Complete=0, Response Axis=1, Response Type=0x14 (Error), Error codes=0x09FF (Invalid Attribute), bytes 6-7 echo command assembly bytes 2-3.
5. Controller waits for either the Load Complete flag to transition high or for an Error Response Type in the response assembly, then clears Load/Start. Ready for next command	Clear Load/Start C: 0x80 0x00 0x21 0x20 0xE8 0x03 0x00 0x00 Enable=1, Load/Start=0, Command Axis=1, Command Type=1, Response Axis=1, Data=1000

### 5.1.4 Command Assembly 0x01 – Target Position

This Polled I/O command assembly is used to start a trajectory (Position Opmode only) of the specified distance.

The trajectory can be absolute or relative, depending on the value of the Relative bit. In position Opmode, a move will begin as soon as the target position is loaded. For this reason, load the target position last, after velocity, acceleration and deceleration.

The target position stored here corresponds to the Target Position attribute of the Position Controller object (class 0x25, instance 1, attribute 0x06). The value may also be accessed through the serial terminal command O\_P. This assembly only affects motion task 0 – Command Blocks (motion tasks) 1-255 are unaffected.

Byte	Bit 7	Bit 6	Bit 5	Bit 4	Bit 3	Bit 2	Bit 1	Bit 0
0	Enable	Reg Arm	Hard Stop	Smooth Stop	Dir	Relative	Start Block	Load / Start
1	Block Number							
2	Command axis = 001			Command Assembly Type (00001)				
3	Response axis = 001			Response Assembly Type				
4	Target Position Low Byte							
5	Target Position Low Middle Byte							
6	Target Position High Middle Byte							
7	Target Position High Byte							

See Control Bits and Data Fields for bit descriptions.

Shown below is an example for the servo amplifiers. The target position is set to 1000 position units, or 0x000003E8 in hexadecimal. The Enable bit is set since setting this value will initiate motion; the Relative bit is set to indicate a relative position move; the Load/Start bit is set to begin handshaking. In this example, the Response Assembly Type is set to response assembly 3 – Actual Velocity. The amplifier will transmit the actual velocity when it responds to this command.

See the Data Handshaking section above for details on sending a Polled I/O command. Follow the correct sequence with the command assembly Load/Start bit and the response assembly Load Complete bit. Check for an error response by looking for the Error Response code 0x14 in the Response Assembly Type field of the response assembly.

Byte	Bit 7	Bit 6	Bit 5	Bit 4	Bit 3	Bit 2	Bit 1	Bit 0
0	1	0	0	0	0	1	0	1
1	0							
2	0	0	1	0	0	0	0	1
3	0	0	1	0	0	0	1	1
4	0xE8							
5	0x03							
6	0x00							
7	0x00							

### 5.1.5 Command Assembly 0x02 – Target Velocity

This Polled I/O command assembly is used to change the target velocity in position or velocity opmode. The Dir bit sets the desired direction in Velocity Mode and is ignored in all other modes. In Velocity Mode, the move will begin as soon as the target velocity is loaded. In Position Mode, movement will not start when the target velocity is loaded.

In position opmode, the velocity stored here corresponds to the Target Velocity attribute of the Position Controller object (class 0x25, instance 1, attribute 0x07). In velocity opmode, the velocity stored here corresponds to the Jog Velocity attribute of the Position Controller object (class 0x25, instance 1, attribute 0x16). This assembly only affects motion task 0 – Command Blocks (motion tasks) 1-255 are unaffected.

The units are determined by the amplifier setup (VUNIT, Position Controller attributes 40-41).

Byte	Bit 7	Bit 6	Bit 5	Bit 4	Bit 3	Bit 2	Bit 1	Bit 0
0	Enable	Reg Arm	Hard Stop	Smooth Stop	Dir	Relative	Start Block	Load / Start
1	Block Number							
2	Command axis = 001			Command Assembly Type (00010)				
3	Response axis = 001			Response Assembly Type				
4	Target Velocity Low Byte							
5	Target Velocity Low Middle Byte							
6	Target Velocity High Middle Byte							
7	Target Velocity High Byte							

See Control Bits and Data Fields for bit descriptions.

Shown below is an example for the servo amplifiers. The target velocity is set to 20000 counts/sec, or 0x00004e20 in hexadecimal. The Enable bit is set to enable the amplifier; the Direction bit is cleared, so motion will be in the negative direction if the amplifier is in Velocity Mode; the Load/Start bit is set to begin handshaking. In velocity mode, the amplifier will immediately accelerate or decelerate to -20000 counts/sec. In position mode, the target velocity will be loaded for the next trajectory. In this example, the Response Assembly Type is set to response assembly 1 – Actual Position. The amplifier will transmit the actual position when it responds to this command (refer to Response Assembly 0x01 – Actual Position for more information).

See the Data Handshaking section above for details on sending a Polled I/O command. Follow the correct sequence with the command assembly Load/Start bit and the response assembly Load Complete bit. Check for an error response by looking for the Error Response code 0x14 in the Response Assembly Type field of the response assembly.

Byte	Bit 7	Bit 6	Bit 5	Bit 4	Bit 3	Bit 2	Bit 1	Bit 0
0	1	0	0	0	0	0	0	1
1	0							
2	0	0	1	0	0	0	1	0
3	0	0	1	0	0	0	0	1
4	0x20							
5	0x4E							
6	0x00							
7	0x00							

### 5.1.6 Command Assembly 0x03 – Acceleration

This Polled I/O command assembly is used to change the acceleration in position or velocity opmode.

The acceleration value stored here corresponds to the Acceleration attribute of the Position Controller object (class 0x25, instance 1, attribute 0x08). When in velocity opmode, the drive parameter ACC is set. When in position opmode, the drive parameter ACCR is set.

Byte	Bit 7	Bit 6	Bit 5	Bit 4	Bit 3	Bit 2	Bit 1	Bit 0
0	Enable	Reg Arm	Hard Stop	Smooth Stop	Dir	Relative	Start Block	Load / Start
1	Block Number							
2	Command axis = 001			Command Assembly Type (00011)				
3	Response axis = 001			Response Assembly Type				
4	Acceleration Low Byte							
5	Acceleration Low Middle Byte							
6	Acceleration High Middle Byte							
7	Acceleration High Byte							

See Control Bits and Data Fields for bit descriptions.

Shown below is an example for the S600 amplifiers. The acceleration is set to 20000 counts/sec<sup>2</sup>, or 0x00004e20 in hexadecimal. The Enable bit is set to enable the amplifier; the Load/Start bit is set to begin handshaking. In this example, the Response Assembly Type is set to response assembly 1 – Actual Position. The amplifier will transmit the actual position when it responds to this command (refer to Response Assembly 0x01 – Actual Position for more information).

See the Data Handshaking section above for details on sending a Polled I/O command. Follow the correct sequence with the command assembly Load/Start bit and the response assembly Load Complete bit. Check for an error response by looking for the Error Response code 0x14 in the Response Assembly Type field of the response assembly.

Byte	Bit 7	Bit 6	Bit 5	Bit 4	Bit 3	Bit 2	Bit 1	Bit 0
0	1	0	0	0	0	0	0	1
1	0							
2	0	0	1	0	0	0	1	1
3	0	0	1	0	0	0	0	1
4	0x20							
5	0x4E							
6	0x00							
7	0x00							

### 5.1.7 Command Assembly 0x04 – Deceleration

This Polled I/O command assembly is used to change the deceleration in position or velocity opmode.

The deceleration value stored here corresponds to the Deceleration attribute of the Position Controller object (class 0x25, instance 1, attribute 0x09). When in velocity opmode, the drive parameter DEC is set. When in position opmode, the drive parameter DECR is set.

Byte	Bit 7	Bit 6	Bit 5	Bit 4	Bit 3	Bit 2	Bit 1	Bit 0
0	Enable	Reg Arm	Hard Stop	Smooth stop	Dir	Relative	Start Block	Load / Start
1	Block Number							
2	Command axis = 001			Command Assembly Type (00100)				
3	Response axis = 001			Response Assembly Type				
4	Deceleration Low Byte							
5	Deceleration Low Middle Byte							
6	Deceleration High Middle Byte							
7	Deceleration High Byte							

See Control Bits and Data Fields for bit descriptions.

Shown below is an example for the servo amplifiers. The deceleration is set to 20000 counts/sec<sup>2</sup>, or 0x00004e20 in hexadecimal. The Enable bit is set to enable the amplifier; the Load/Start bit is set to begin handshaking. In this example, the Response Assembly Type is set to response assembly 1 – Actual Position. The amplifier will transmit the actual position when it responds to this command (refer to Response Assembly 0x01 – Actual Position for more information).

See the Data Handshaking section above for details on sending a Polled I/O command. Follow the correct sequence with the command assembly Load/Start bit and the response assembly Load Complete bit. Check for an error response by looking for the Error Response code 0x14 in the Response Assembly Type field of the response assembly.

Byte	Bit 7	Bit 6	Bit 5	Bit 4	Bit 3	Bit 2	Bit 1	Bit 0
0	1	0	0	0	0	0	0	1
1	0							
2	0	0	1	0	0	1	0	0
3	0	0	1	0	0	0	0	1
4	0x20							
5	0x4E							
6	0x00							
7	0x00							

### 5.1.8 Command Assembly 0x05 – Torque

This Polled I/O command assembly is used to change the torque. This can only be used in torque mode. Motion will begin as soon as the value is loaded.

The torque value stored here corresponds to the Torque attribute of the Position Controller object (class 0x25, instance 1, attribute 0x19). The value may also be accessed through the serial terminal command T.

Byte	Bit 7	Bit 6	Bit 5	Bit 4	Bit 3	Bit 2	Bit 1	Bit 0
0	Enable	Reg Arm	Hard Stop	Smooth Stop	Dir	Relative	Start Block	Load / Start
1	Block Number							
2	Command axis = 001			Command Assembly Type (00101)				
3	Response axis = 001			Response Assembly Type				
4	Torque Low Byte							
5	Torque Low Middle Byte							
6	Torque High Middle Byte							
7	Torque High Byte							

See Control Bits and Data Fields for bit descriptions.

Shown below is an example for the servo amplifiers. In this example, the torque (current) is set to 3.0A in a 6.0A peak amplifier. Torque units are scaled to 3280=peak current, so the command value is  $3280 \times 3.0 / 6.0 = 1640$  torque units, or 0x00000668 in hexadecimal. The Enable bit is set to enable the amplifier; the Load/Start bit is set to begin handshaking. In Torque Mode, motion will begin as soon as the torque command is loaded. In this example, the Response Assembly Type is set to response assembly 1 – Actual Position. The amplifier will transmit the actual position when it responds to this command (refer to Response Assembly 0x01 – Actual Position for more information).

See the Data Handshaking section above for details on sending a Polled I/O command. Follow the correct sequence with the command assembly Load/Start bit and the response assembly Load Complete bit. Check for an error response by looking for the Error Response code 0x14 in the Response Assembly Type field of the response assembly.

Byte	Bit 7	Bit 6	Bit 5	Bit 4	Bit 3	Bit 2	Bit 1	Bit 0
0	1	0	0	0	0	0	0	1
1	0							
2	0	0	1	0	0	1	0	1
3	0	0	1	0	0	0	0	1
4	0x68							
5	0x06							
6	0x00							
7	0x00							

## 5.2 I/O Response Assemblies

Polled I/O Messaging is a method of transmitting a group of control bits and a data command and receiving back a group of status bits and a data value response. This method of communication is preferred, as explicit messaging can transmit only a single value at a time. Polled I/O Messaging is a method of communicating to devices a group of specific commands. This method of communication is preferred, as it is faster than explicit messaging. Polled I/O and Explicit Messaging may be used simultaneously for communications between the controller and the amplifier. In this section, the format of each Response Assembly is defined and examples of each are provided.

In Polled I/O Messaging, the amplifier transmits a response assembly when it receives a command assembly from the amplifier. The response assembly has status bits which are defined the same for each type of response. In addition to status bits, a response assembly can transmit one data value at a time (actual position, commanded position, actual velocity, actual torque or error values). The response type is specified in the Response Assembly Type field of the command assembly. A command assembly may contain both a Command Assembly Type and a Response Assembly Type to transmit a command and request a data value in the same assembly.

### 5.2.1 Status Bits and Data Fields

Byte	Bit 7	Bit 6	Bit 5	Bit 4	Bit 3	Bit 2	Bit 1	Bit 0
0	Enable state	Reg level	Home level	Current dir	General fault	in position	Block Executing	in Motion
1	Executing Block Number							
2	Load complete	Block fault	Following error	Negative SW limit	Positive SW limit	Negative HW limit	Positive HW limit	Fault input active
3	Response Axis = 001			Response Assembly Type				
4	Data Low Byte							
5	Data Low Middle Byte							
6	Data High Middle Byte							
7	Data High Byte							

<b>Enable State</b>	This bit reflects the enable state of the amplifier. See also Enable (class 0x25 Position Controller, attribute 0x11).
<b>Registration Level</b>	The actual level of the registration input. Digital input 2 must be configured for registration.
<b>Home Level</b>	This bit reflects the level of the Home Input of the amplifier.
<b>Current Direction</b>	This bit reflects the actual direction of motion. When the drive is not in motion, this bit shows the direction of the last commanded move. See also Direction (class 0x25 Position Controller, attribute 0x17).
<b>General Fault</b>	This bit indicates whether or not a fault has occurred. See also General Fault (class 0x24 Position Controller Supervisor, attribute 0x05).
<b>in position</b>	This bit indicates whether or not the motor is on the last targeted position (1=On Target). See also Incremental Position Flag (class 0x25 Position Controller, attribute 0x0C).
<b>Block Executing</b>	When set, indicates amplifier is running a block command program. See also Block Execute (class 0x26 Block Sequencer, attribute 0x02).
<b>Executing Block Number</b>	Indicates the number (instance) of the currently executing block when the Block Executing bit is high (1). See also Current Block (class 0x26 Block Sequencer, attribute 0x03).
<b>In Motion</b>	This bit indicates whether a trajectory is in progress (1) or has completed (0). This bit is set immediately when motion begins and remains set for the entire motion. See also Start Trajectory (class 0x25 Position Controller, attribute 0x0B).



<b>Load Complete</b>	This bit indicates that the command data contained in the command message has been successfully loaded into the device. Used for handshaking between the controller and amplifier – see Data Handshaking.
<b>Block Fault</b>	This bit is set to indicate that an error has occurred in the command block program sequencing. Read the Block Fault Code (class 0x26 Block Sequencer, attribute 0x05) to clear the error. See also Block Fault (class 0x26 Block Sequencer, attribute 0x04).
<b>Following Error</b>	This bit indicates when a following (static or dynamic) error occurs. Clear faults to continue motion (class 0x24 Position Controller Supervisor, attribute 0x64 – Clear Faults).
<b>Negative SW Limit</b>	This bit indicates when the position is less than or equal to the Negative Software Limit Position.
<b>Positive SW Limit</b>	This bit indicates when the position is greater than or equal to the Positive Software Limit Position.
<b>Negative HW Limit</b>	This bit indicates the state of the Negative Hardware Limit Input.
<b>Positive HW Limit</b>	This bit indicates the state of the Positive Hardware Limit Input.
<b>Fault Input Active</b>	This bit indicates the state of the Emergency Stop input. One of the digital inputs 1-4 must be configured as an emergency stop, e.g. IN1MODE=27.
<b>Response Axis</b>	The amplifier supports only one axis, so this value must always be 1. The value is echoed from the command assembly.
<b>Response Assembly Type</b>	Set the response type in the command assembly to determine what data will be returned in the Data field of the response assembly. The actual position, target position, actual velocity, and actual torque are available. The response assembly echoes the Response Assembly Type from the command assembly, except when there is an error in the command assembly. If the command assembly is invalid, the response assembly's Response Assembly Type will be set to 0x14 (Error Response) and an error code will be returned in the Data field.
<b>Data Bytes</b>	Response data for the desired response type will be loaded into the data fields, least significant byte first.

**5.2.2 Response Assembly 0x01 – Actual Position**

This Polled I/O response assembly is used to return the Actual Position of the motor (in position units).

The actual position returned here corresponds to the Actual Position attribute of the Position Controller object (class 0x25, instance 1, attribute 0x0D). The value may also be accessed through the serial terminal command PFB.

Byte	Bit 7	Bit 6	Bit 5	Bit 4	Bit 3	Bit 2	Bit 1	Bit 0
0	Enable state	Reg level	Home level	Current dir	General fault	in position	Block Executing	In Motion
1	Executing Block Number							
2	Load complete	Block fault	Following error	Negative SW limit	Positive SW limit	Negative HW limit	Positive HW limit	Fault input active
3	Response Axis = 001			Response Assembly Type (00001)				
4	Actual position Low Byte							
5	Actual position Low Middle Byte							
6	Actual position High Middle Byte							
7	Actual position High Byte							

See Status Bits and Data Fields for definitions of the individual bits and fields.

Shown below is an example for the servo amplifiers. The actual position is 10,000 position units, or 0x00002710 in hexadecimal

- Enable State = 1 (enabled)
- Registration Level = 0 (not active)
- Home Level = 0 (not on the home flag)
- Current Direction = 1 (positive direction)
- General Fault = 0 (no faults)
- in position = 1 (in position)
- Block Executing = 0 (command block program not executing)
- In Motion = 0 (not in motion)
- Load Complete = 1 (Command Assembly data was loaded successfully)
- Block Fault = 0 (no fault)
- Following Error = 0 (no error)
- Negative SW Limit = 0 (not on limit)
- Positive SW Limit = 1 (on limit)
- Negative HW Limit = 0 (Negative direction limit switch inactive)
- Positive HW Limit = 1 (Positive direction limit switch active)
- Fault Input Active = 0 (emergency stop inputs inactive)
- Response Axis = 001
- Response Assembly Type = 00001
- Data = 0x00002710

Byte	Bit 7	Bit 6	Bit 5	Bit 4	Bit 3	Bit 2	Bit 1	Bit 0
0	1	0	0	1	0	1	0	0
1	0							
2	1	0	0	0	1	0	1	0
3	0	0	1	0	0	0	0	1
4	0x10							
5	0x27							
6	0x00							
7	0x00							

### 5.2.3 Response Assembly 0x02 – Commanded Position

This Polled I/O response assembly is used to return the commanded position of the motor (in position units).

The value may also be accessed through the serial terminal command PTARGET.

Byte	Bit 7	Bit 6	Bit 5	Bit 4	Bit 3	Bit 2	Bit 1	Bit 0
0	Enable state	Reg level	Home level	Current dir	General fault	in position	Block Executing	In Motion
1	Executing Block Number							
2	Load complete	Block fault	Following error	Negative SW limit	Positive SW limit	Negative HW limit	Positive HW limit	Fault input active
3	Response Axis = 001			Response Assembly Type (00010)				
4	Commanded position Low Byte							
5	Commanded position Low Middle Byte							
6	Commanded position High Middle Byte							
7	Commanded position High Byte							

See Status Bits and Data Fields for definitions of the individual bits and fields.

Shown below is an example for the servo amplifiers. The commanded position is 10,000 position units, or 0x00002710 in hexadecimal.

Enable State = 1 (enabled)  
 Registration Level = 0 (not active)  
 Home Level = 0 (not on the home flag)  
 Current Direction = 1 (positive direction)  
 General Fault = 0 (no faults)  
 in position = 1 (in position)  
 Block Executing = 0 (command block program not executing)  
 In Motion = 0 (not in motion)  
 Load Complete = 1 (Command Assembly data was loaded successfully)  
 Block Fault = 0 (no fault)  
 Following Error = 0 (no error)  
 Negative SW Limit = 0 (not on limit)  
 Positive SW Limit = 1 (on limit)  
 Negative HW Limit = 0 (Negative direction limit switch inactive)  
 Positive HW Limit = 0 (Positive direction limit switch inactive)  
 Fault Input Active = 0 (emergency stop inputs inactive)  
 Response Axis = 001  
 Response Assembly Type = 00010  
 Data = 0x00002710

Byte	Bit 7	Bit 6	Bit 5	Bit 4	Bit 3	Bit 2	Bit 1	Bit 0
0	1	0	0	1	0	1	0	0
1	0							
2	1	0	0	0	1	0	0	0
3	0	0	1	0	0	0	1	0
4	0x10							
5	0x27							
6	0x00							
7	0x00							

**5.2.4 Response Assembly 0x03 – Actual Velocity**

This Polled I/O response assembly returns the actual velocity of the motor. The units are determined by the amplifier setup (VUNIT, Position Controller attributes 40-41).

The actual velocity returned here corresponds to the Actual Velocity attribute of the Position Controller object (class 0x25, instance 1, attribute 0x0E). The value may also be accessed through the serial terminal command PV. The units are determined by the amplifier setup (VUNIT, Position Controller attributes 40-41).

Byte	Bit 7	Bit 6	Bit 5	Bit 4	Bit 3	Bit 2	Bit 1	Bit 0
0	Enable state	Reg level	Home level	Current dir	General fault	in position	Block Executing	In Motion
1	Executing Block Number							
2	Load complete	Block fault	Following error	Negative SW limit	Positive SW limit	Negative HW limit	Positive HW limit	Fault input active
3	Response Axis = 001			Response Assembly Type (00011)				
4	Actual velocity Low Byte							
5	Actual velocity Low Middle Byte							
6	Actual velocity High Middle Byte							
7	Actual velocity High Byte							

See Status Bits and Data Fields for definitions of the individual bits and fields.

Shown below is an example for the servo amplifiers. The actual velocity is 10,000 position units/sec, or 0x00002710 in hexadecimal.

- Enable State = 1 (enabled)
- Registration Level = 0 (not active)
- Home Level = 0 (not on the home flag)
- Current Direction = 1 (positive direction)
- General Fault = 0 (no faults)
- in position = 1 (in position)
- Block Executing = 0 (command block program not executing)
- In Motion = 0 (not in motion)
- Load Complete = 1 (Command Assembly data was loaded successfully)
- Block Fault = 0 (no fault)
- Following Error = 0 (no error)
- Negative SW Limit = 0 (not on limit)
- Positive SW Limit = 1 (on limit)
- Negative HW Limit = 0 (Negative direction limit switch inactive)
- Positive HW Limit = 0 (Positive direction limit switch inactive)
- Fault Input Active = 0 (emergency stop inputs inactive)
- Response Axis = 001
- Response Assembly Type = 00011
- Data = 0x00002710

Byte	Bit 7	Bit 6	Bit 5	Bit 4	Bit 3	Bit 2	Bit 1	Bit 0
0	1	0	0	1	0	1	0	0
1	0							
2	1	0	0	0	1	0	0	0
3	0	0	1	0	0	0	1	1
4	0x10							
5	0x27							
6	0x00							
7	0x00							

### 5.2.5 Response Assembly 0x05 – Torque

This Polled I/O response assembly returns the actual torque (current) of the motor.

The actual torque returned here corresponds to the Torque attribute of the Position Controller object (class 0x25, instance 1, attribute 0x19). The value may also be accessed through the serial terminal command T.

Byte	Bit 7	Bit 6	Bit 5	Bit 4	Bit 3	Bit 2	Bit 1	Bit 0
0	Enable state	Reg level	Home level	Current dir	General fault	in position	Block Executing	In Motion
1	Executing Block Number							
2	Load complete	Block fault	Following error	Negative SW limit	Positive SW limit	Negative HW limit	Positive HW limit	Fault input active
3	Response Axis = 001			Response Assembly Type (00101)				
4	Torque Low Byte							
5	Torque Low Middle Byte							
6	Torque High Middle Byte							
7	Torque High Byte							

See Status Bits and Data Fields for definitions of the individual bits and fields.

Shown below is an example for the servo amplifiers. The actual torque (current) is 3.0A in a 6.0A peak amplifier. Torque units are scaled to 3280=peak current, so the actual torque value is  $3280 \times 3.0 / 6.0 = 1640$  torque units, or 0x00000668 in hexadecimal.

Enable State = 1 (enabled)  
 Registration Level = 0 (not active)  
 Home Level = 0 (not on the home flag)  
 Current Direction = 1 (positive direction)  
 General Fault = 0 (no faults)  
 in position = 1 (in position)  
 Block Executing = 0 (command block program not executing)  
 In Motion = 1 (motion in progress)  
 Load Complete = 0 (no data loaded from the Command Assembly)  
 Block Fault = 0 (no fault)  
 Following Error = 0 (no error)  
 Negative SW Limit = 0 (not on limit)  
 Positive SW Limit = 0 (not on limit)  
 Negative HW Limit = 0 (Negative direction limit switch inactive)  
 Positive HW Limit = 0 (Positive direction limit switch inactive)  
 Fault Input Active = 0 (emergency stop inputs inactive)  
 Response Axis = 001  
 Response Assembly Type = 00101  
 Data = 0x00000668

Byte	Bit 7	Bit 6	Bit 5	Bit 4	Bit 3	Bit 2	Bit 1	Bit 0
0	1	0	0	1	0	1	0	1
1	0							
2	0	0	0	0	0	0	0	0
3	0	0	1	0	0	1	0	1
4	0x68							
5	0x06							
6	0x00							
7	0x00							

5.2.6 Response Assembly 0x14 – Command/Response Error

This Polled I/O response identifies an error that has occurred. This response will always be returned in response to an invalid Command Assembly. The Response Assembly Type field of the response assembly usually echoes the matching field from the previous command assembly. In case of an invalid command assembly, the Response Assembly Type field of the response assembly will be set to 0x14 and error codes will be returned in the Data field.

Byte	Bit 7	Bit 6	Bit 5	Bit 4	Bit 3	Bit 2	Bit 1	Bit 0
0	Enable state	Reg level	Home level	Current dir	General fault	in position	Block Executing	In Motion
1	Executing Block Number							
2	Load complete	Block fault	Following error	Negative SW limit	Positive SW limit	Negative HW limit	Positive HW limit	Fault input active
3	Response Axis = 001			Response Assembly Type (10100)				
4	Error code							
5	Additional code							
6	Copy of command message byte2 (command axis and type)							
7	Copy of command message byte3 (response axis and type)							

Error Code (hex)	Additional Code (hex)	DeviceNet Error
0	FF	NO ERROR
2	FF	RESOURCE_UNAVAILABLE
5	FF	PATH_UNKNOWN
5	1	COMMAND_AXIS_INVALID
5	2	RESPONSE_AXIS_INVALID
8	FF	SERVICE_NOT_SUPP
8	1	COMMAND_NOT_SUPPORTED
8	2	RESPONSE_NOT_SUPPORTED
9	FF	INVALID_ATTRIBUTE_VALUE
B	FF	ALREADY_IN_STATE
C	FF	OBJ_STATE_CONFLICT
D	FF	OBJECT_ALREADY_EXISTS
E	FF	ATTRIBUTE_NOT_SETTABLE
F	FF	ACCESS_DENIED
10	FF	DEVICE_STATE_CONFLICT
11	FF	REPLY_DATA_TOO_LARGE
13	FF	NOT_ENOUGH_DATA
14	FF	ATTRIBUTE_NOT_SUPP
15	FF	TOO_MUCH_DATA
16	FF	OBJECT_DOES_NOT_EXIST
17	FF	FRAGMENTATION_SEQ_ERR
20	FF	INVALID_PARAMETER

Shown below is an example for the servo amplifiers. The previous Command Assembly requested command 0x06 (not supported) and response 0x01. The amplifier returns Response Assembly 0x14 (Command/Response Error) with Error Code = 0x08 and Additional Code = 0x01 (COMMAND\_NOT\_SUPPORTED). Bytes 2 and 3 from the Command Assembly are echoed in the Error Response Assembly.

Byte	Bit 7	Bit 6	Bit 5	Bit 4	Bit 3	Bit 2	Bit 1	Bit 0
0	1	0	0	1	0	1	0	1
1	0							
2	0	0	0	0	0	0	0	0
3	0	0	1	1	0	1	0	0
4	0x08							
5	0x01							
6	0x26							
7	0x21							

## 6 Appendix

### 6.1 DeviceNet PLC Examples

#### 6.1.1 Overview

DeviceNet provides three methods for controlling motion – Explicit Messages, Assembly Messages, and Command Block Sequences. Each method provides advantages over the others in certain situations. Typically, Explicit Messages are used to configure the amplifier, Assemblies are used to control movement, and Command Blocks are used when stored motion sequences may be executed without much PLC involvement.

Most PLC's will support both Explicit and Polled I/O (Assembly) messaging simultaneously. The objects described in Section 4 are all accessed through Explicit Messaging. Section 5 describes the use of Polled I/O command and response assemblies. Command Block Sequences can be setup through Explicit Messages and then controlled with either Explicit Messages or Polled I/O.

Explicit Messages allow you to access a single parameter value at a time. The desired parameter is selected by specifying the class number, instance number and attribute number in an explicit message. Assemblies combine many control and status bits into 8-byte command and response messages. They are less versatile than explicit messages (only certain parameters are accessible), but several control values may be changes within one message. For this reason, Explicit Messages are better for configuration and Assemblies are better for motion control.

Most drive configuration is done within the Position Controller Object, which encompasses most parameters necessary for motion control. Modify parameters in this object to set the operational mode (torque, velocity, position) and configure motion in the servo amplifier. View parameters in this object to read the drive parameters and status words. Additional drive configuration may be done through another supported object, the Parameter Object. This is a vendor-defined object which exposes vendor configuration parameters. Any drive parameter with a DPR number less than 256 (see the `ascii.chm` reference) may be accessed through the Parameter Object.

Polled I/O Assemblies are used for most motion control. Polled I/O consists of a Command Assembly from the PLC to the servo amplifier and a Response Assembly from the servo amplifier to the PLC. Control bits in a command message are used to enable the amplifier, perform a controlled stop of the motor, initiate motion, or initiate stored motion block programs. Command messages can also set the target position, target velocity, acceleration, deceleration or torque parameters. Status bits in a response message display error states and the general state of the amplifier. Response messages can also display the actual position, commanded position, actual velocity or torque.

Motion sequences or tasks may be pre-programmed into the amplifier through the Command Block Object class. These blocks correspond to the servo amplifier motion tasking feature. Positioning moves, time delays, and parameter modification blocks may be linked together to create a motion block program that is stored in the amplifier. Once the stored block program has been configured, it may be executed through either the Block Sequencer Object or with the Polled I/O Command Message block number field and start block bit.

### 6.1.2 Amplifier Setup for the Examples

To test our examples, start by configuring your amplifier to match our example setup.

In the Basic Setup screen, set:

Acceleration units = ms->VLIM  
Velocity units = rpm  
Position units = counts

In the Position->Position Data screen, set:

Resolution = 1000 counts / revolution

In the Digital IO screen, set:

DIGITAL-OUT 1 = 23: Reserved

(Digital output function 23 puts the digital output under field bus control).

Save parameters and restart the amplifier.

The examples in this section assume these units have been set. The amplifier must also be properly tuned and configured before continuing.

When the amplifier is properly configured, execute the following command sequence from the serial terminal to test. The motor shaft should rotate 1 revolution in 1 second when the MOVE 0 command is entered.

Command	Description
OPMODE 8	Put the amplifier in position mode.
EN	Enable
MH	Move Home
O_C 8193	Incremental move using user units
O_P 1000	Move 1000 counts (1 revolution)
O_V 60	Velocity=60 RPM
O_ACC1 10	Acceleration = 10ms to target velocity
O_DEC1 10	Deceleration = 10ms to target velocity
MOVE 0	Execution motion task 0

### 6.1.3 Polled I/O Assemblies

Assemblies are described thoroughly in the following sections: Typical Use of Explicit and Assembly Messages, Command Assemblies, and Response Assemblies. See these sections for information on the structure and use of command and response assemblies.

For Polled I/O Assembly messaging, the PLC initiates communication with a Command Assembly and the amplifier responds with a Response Assembly. The PLC sends these messages at a regular 'poll rate'. A handshaking protocol is used to ensure that data is transmitted correctly – see the Data Handshaking section for a description of this protocol.



### 6.1.3.1 Sending Command Assemblies - ControlLogix

The servo amplifier may be controlled by Allen Bradley's Logix 5000 Series PLC's with DeviceNet Scanners (1756-DNB) using Polled I/O Assembly Messages. Command Assemblies are sent from the PLC to the amplifier to control drive motion. The format of the command assembly is shown in section 5.1.1.

In order to communicate with the servo amplifier via Assemblies, the amplifier must first be mapped into the PLC's scan list (mapping is not described in this document) and the Command Assembly must be mapped into the output memory of the PLC. See your DeviceNet Scanner manual for instructions on setting up a scan list and mapping input and output memory with RSNetworkx. Ensure that you are using the correct slot number. The servo amplifier command and response assemblies are both eight bytes long and are each mapped into two 32-bit words in the PLC. Bytes 0-3 of the assembly are mapped into bytes 0-3 of word 0 and bytes 4-7 of the assembly are mapped into bytes 0-3 of word 1.

If you have only a single servo amplifier in the PLC scan list and the scanner is in slot 1, your output file mapping may look like this:

Output Word	Description
Local:1:O.Data	DN Scanner output memory
Local:1:O.Data[0]	DN command word 0 (control flags, block number, command choice, response choice)
Local:1:O.Data[1]	DN command word 1 (command data)
Local:1:O.Data[2-123]	Unmapped area of DN Scanner (available for other devices)

Once the outputs are mapped, you may modify the Command Assembly being sent to the amplifier by writing to the appropriate output words. The new data will be transmitted on the next scan cycle and will be transmitted each scan cycle until the output file is modified again. To test, try setting the target velocity to 1000. The value can be checked through the terminal with the command `O_V`. Change the PLC output command assembly (Scanner output data) to the following:

Byte	Function	Data Value (hex)
0	Command Flags – Disable	0x00
1	Block Number	0x00
2	Axis Instance; Command Assembly 2 – Target Velocity	0x22
3	Axis Instance; Response Assembly 1 – Actual Position	0x21
4	Target Velocity – Lower Word Lower Byte	0xE8
5	Target Velocity – Lower Word Upper Byte	0x03
06	Target Velocity – Upper Word Lower Byte	0x00
7	Target Velocity – Upper Word Upper Byte	0x00

Mapping this to the PLC memory should look similar to the table shown below:

Output Word	Data Value (hex)
Local:1:O.Data[0]	0x2122_0000
Local:1:O.Data[1]	0x0000_03E8

For testing, you can modify the data directly from the Program Tags screen:

Tag Name	Value	Force Mask	Style
[-] Local:1:O	{...}	{...}	
[+] Local:1:O.CommandRegi..	{...}	{...}	
[-] Local:1:O.Data	{...}	{...}	Decimal
[+] Local:1:O.Data[0]	16#2122_0000		Hex
[+] Local:1:O.Data[1]	16#0000_03e8		Hex

The command and data are now transmitted to the amplifier on each scan cycle, but the Data Handshaking protocol must be used to load the data (see the Command Assemblies subsection Data Handshaking for more information). Wait for the command assembly to transmit, then set the Load Data bit high by writing 0x2122\_0001 to command word 0 (Local:1:O.Data[0]). Now use the serial terminal to read the value of `O_V` – it should equal 1000.

### 6.1.3.2 Reading Response Assemblies - ControlLogix

A Response Assembly is a Polled I/O message sent to the PLC from the amplifier in response to a command assembly. The amplifier will send a response assembly each time it receives a command assembly from the PLC. If the command assembly is valid and the Response Assembly Type field contains a valid response type, the amplifier will also load the requested data into the response assembly. The data will be refreshed on each Polled I/O cycle until the command assembly changes.

The format of this assembly is shown in section 5.2.1.

The response assembly must be mapped into the input memory of the PLC. See your DeviceNet Scanner manual for instructions on setting up a scan list and mapping the memory with RSNetworkx. Ensure that you are using the correct slot number. See the previous section for a mapping diagram. If you have only a single servo amplifier in the PLC scan list and the scanner is in slot 1, your input file mapping may look like this:

Input Word	Description
Local:1:I.Data	DN Scanner input memory
Local:1:I.Data[0]	DN response word 0 (status flags, block number, response choice)
Local:1:I.Data[1]	DN response word 1 (response data)
Local:1:I.Data[2-123]	Unmapped area of DN scanner (available for other devices)

Once the inputs are mapped, you may read the latest Response Assembly received by the PLC by reading from the appropriate input file. The input files will be updated by the PLC on each scan cycle with data transmitted from the amplifier.

To test, use the output command assembly from the previous section. The example command assembly requests the actual position (Response Assembly Type = 1). After writing this command assembly to the output file, wait for the scan cycle to complete, then read the input file to get the latest response assembly. The response assembly should look something like the following, with the motor's actual position in bytes 4-7:

Byte	Function	Data value (Hex)
0	Response Flags A – Disabled, In Position	0x04
1	Block Executing - none	0x00
2	Response flags B - Load complete, no errors	0x80
3	Axis instance 1; response assembly 1 - actual position	0x21
4	Actual position - lower word lower byte	0x00
5	Actual position - lower word upper byte	0x00
6	Actual position - upper word lower byte	0x00
7	Actual position - upper word upper byte	0x00

Mapping this to the PLC memory should look similar to the table shown below:

Input Word	Data Value (hex)
Local:1:I.Data[0]	0x2180_0004
Local:1:I.Data[1]	0x0000_0000

The screenshot shows the 'Program Tags' screen in a software interface. At the top, there are controls for 'Scope' (set to 'Control\_Logix{contro...}'), 'Show' (set to 'Show All'), and 'Sort' (set to 'Tag Name'). Below this is a table with columns: Tag Name, Value, Force Mask, and Style. The table lists several tags, including 'Local:1:I', 'Local:1:I.StatusRe...', 'Local:1:I.Data', 'Local:1:I.Data[0]', and 'Local:1:I.Data[1]'. The 'Local:1:I.Data[0]' tag is selected, and its value is shown as '16#2180\_0004' with a 'Hex' style. The 'Local:1:I.Data[1]' tag has a value of '16#0000\_0000' and a 'Hex' style.

Tag Name	Value	Force Mask	Style
Local:1:I	{...}	{...}	
Local:1:I.StatusRe...	{...}	{...}	
Local:1:I.Data	{...}	{...}	Decimal
Local:1:I.Data[0]	16#2180_0004		Hex
Local:1:I.Data[1]	16#0000_0000		Hex

You can view the data easily in the Program Tags screen.

The value in Local:1:I.Data[1] should change as you rotate the motor shaft by hand.

### 6.1.3.3 Data Handshaking - ControlLogix

Data handshaking is used to transmit data commands with Command Assemblies. To transmit a command to the amplifier, set the Command Type and load data into the data fields, then toggle the Load/Start bit high. The amplifier will accept data only when Load/Start transitions from 0 to 1. If the data is loaded successfully, the amplifier will set the Load Complete response flag high. Load Complete will be cleared by the amplifier after Load/Start is cleared by the controller. See the Data Handshaking section for more information.

The LoadData subroutine can be used to simplify data handshaking. The subroutine is shown below.

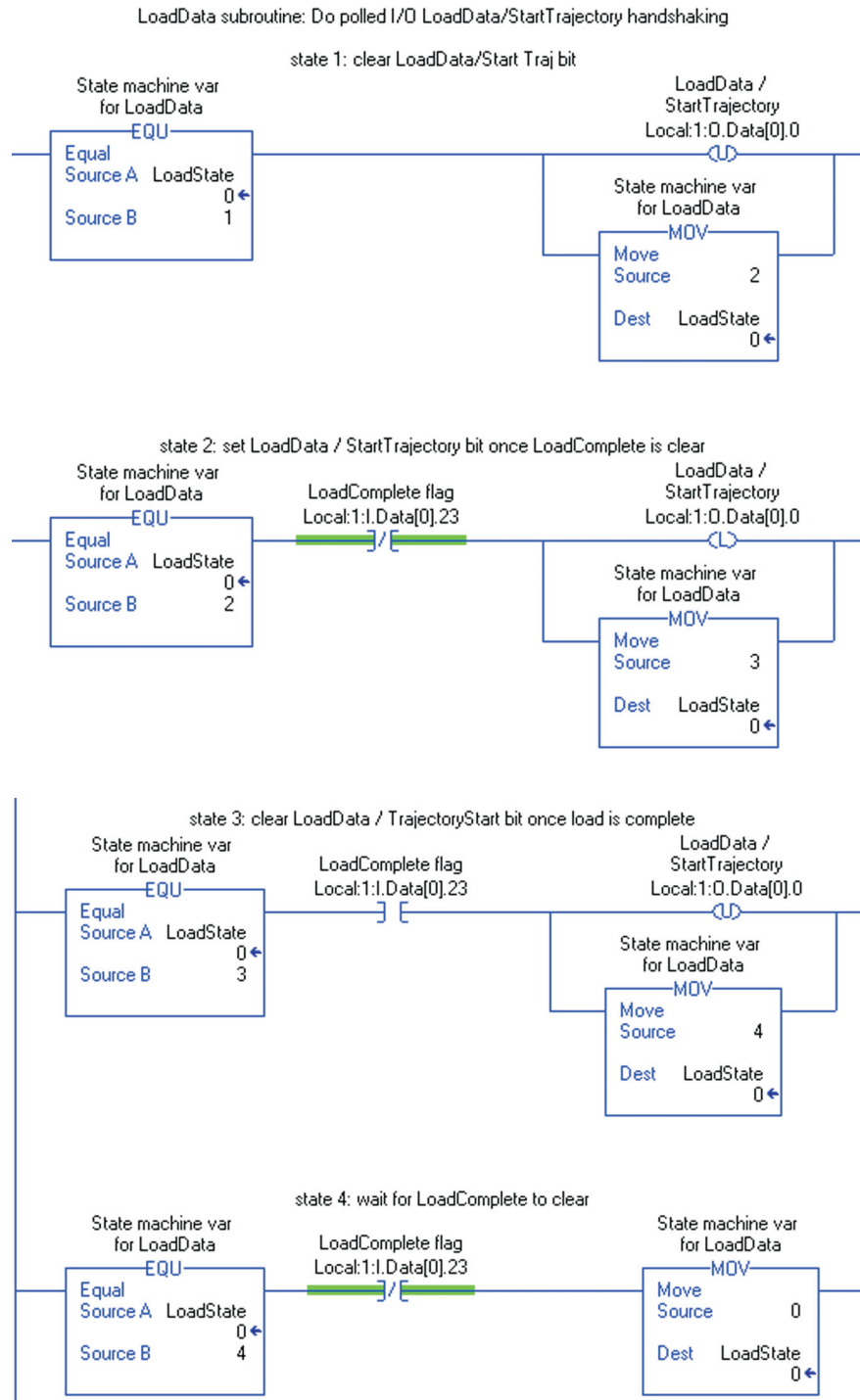

To use LoadData, first copy a proper command assembly into Local:1:O.Data[0-1]. Then set LoadState=1 and call the LoadData subroutine until LoadState has been reset to 0.

### 6.1.3.4 Sending Command Assemblies - SLC500

The servo amplifier may be controlled by Allen Bradley's SLC-5/0X Series PLC's DeviceNet Scanners (1747-SDN/B) using Assembly Messages. Command Assemblies are sent from the PLC to the amplifier to control motion. The format of the command assembly is shown in section 5.1.1.

In order to communicate with the servo amplifiers via Assemblies, the drive must first be mapped into the PLC's scan list (mapping is not described in this document) and the Command Assembly must be mapped into the output memory of the PLC. See your DeviceNet Scanner manual for instructions on setting up a scan list and mapping input and output memory with RSNetworkx. Ensure that you are using the correct slot number. The amplifier command and response assemblies are both eight bytes long and are each mapped into four 32-bit words in the PLC:

If you have only a single servo amplifier in the PLC scan list and the scanner is in slot 1, your output file mapping may look like this:

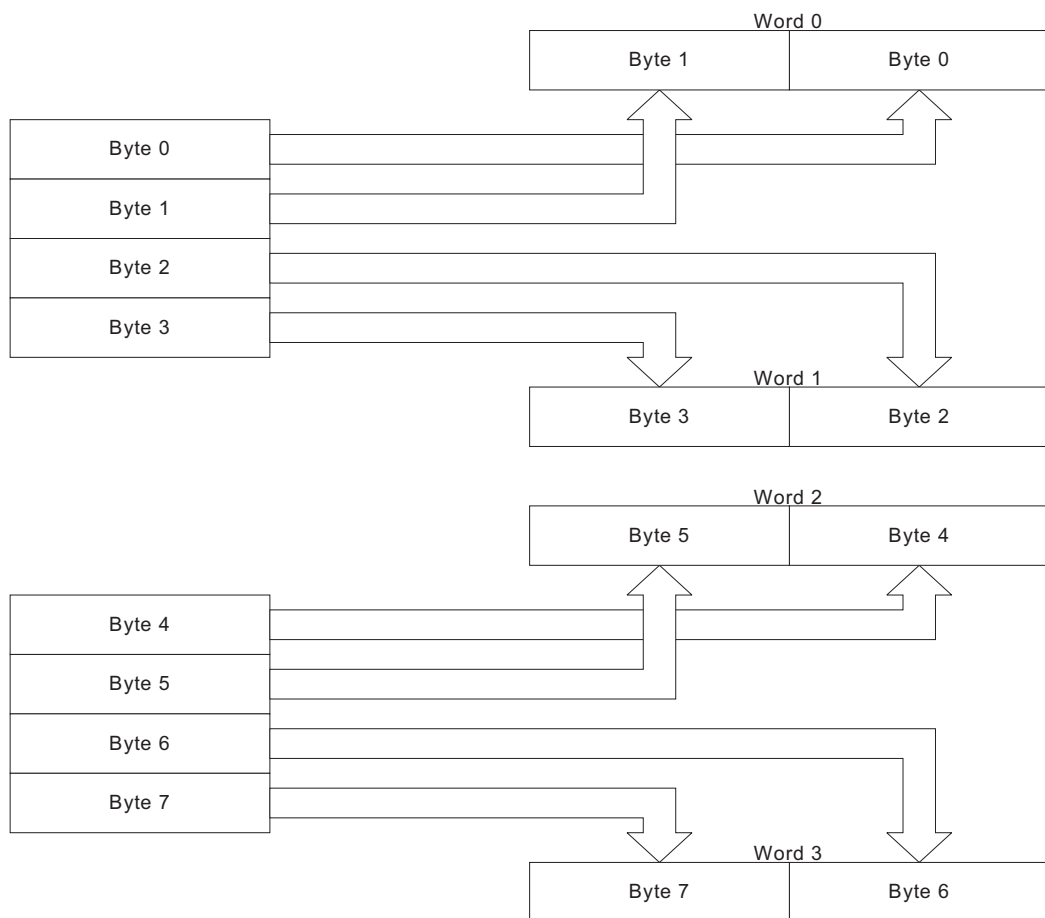

Output Word	Description
O:1.0	DN Scanner Control Word
O:1.0/0	Enable DN Scanner Outputs
O:1.1	DN command word 0 (control flags, block number)
O:1.2	DN command word 1 (command, response)
O:1.3	DN command word 2 (data LSW)
O:1.4	DN command word 3 (data MSW)
O:1.5-31	Unmapped area of DN scanner (available for other devices)

Once the outputs are mapped, you may modify the Command Assembly being sent to the amplifier by writing to the appropriate output file. The new data will be transmitted on the next scan cycle and will be transmitted each scan cycle until the output file is modified again.

To test, try setting the target velocity to 1000. The value can be checked through the terminal with the command O\_V. Change the PLC output command assembly (Scanner output data) to the following:

Byte	Function	Data value (hex)
0	Command Flags – Disable	0x00
1	Block Number	0x00
2	Axis instance, command assembly 2 - target velocity	0x22
3	Axis instance, response assembly 1 - actual position	0x21
4	Target velocity - lower word lower byte	0xE8
5	Target velocity - lower word upper byte	0x03
6	Target velocity - lower word lower byte	0x00
7	Target velocity - upper word upper byte	0x00

Mapping this to the PLC memory should look similar to the table shown below:

Output Word	Data Value (hex)
O:1.1	0000
O:1.2	2122
O:1.3	03E8
O:1.4	0000

For testing, you can modify the data directly from the Program Tags screen:

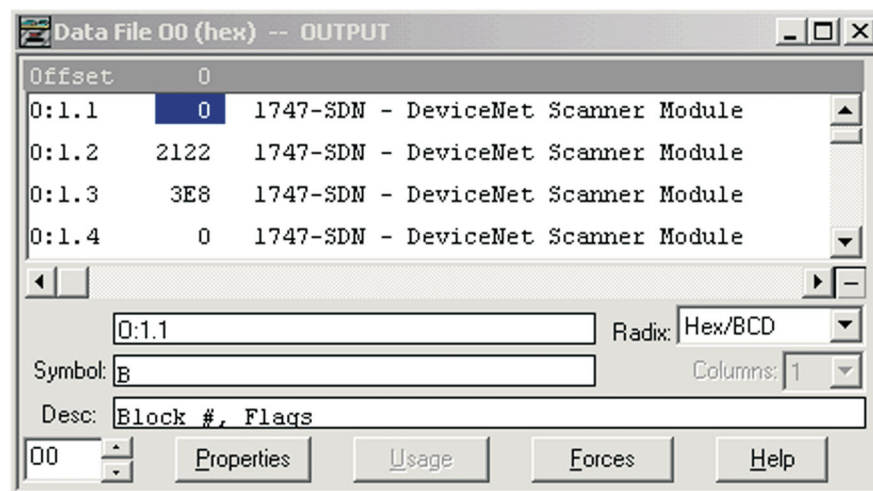

Alternately, a ladder program can load the desired values into the output words (note that the data is displayed here in decimal):

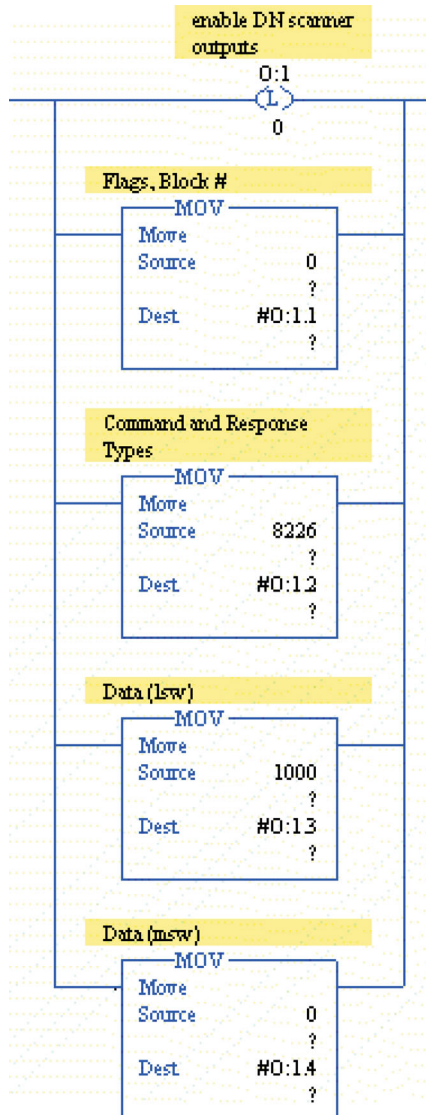

The command and data are now transmitted to the amplifier on each scan cycle, but the Data Handshaking protocol must be used to load the data. Wait for the command assembly to transmit, then set the Load Data bit high by writing 0x0001 to command word 0 (Output Word 0:1.1). Now use the serial terminal to read the value of O\_V – it should equal 1000.

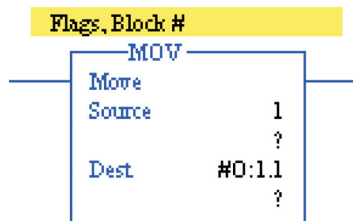

### 6.1.3.5 Reading Response Assemblies - SLC500

A Response Assembly is a Polled I/O message sent to the PLC from the amplifier in response to a command assembly. The amplifier will send a response assembly each time it receives a command assembly from the PLC. If the command assembly is valid and the Response Assembly Type field contains a valid response type, the amplifier will also load the requested data into the response assembly. The data will be refreshed on each Polled I/O cycle until the command assembly changes.

The format of this assembly is shown in section 5.2.1.

The response assembly must be mapped into the input memory of the PLC. See your DeviceNet Scanner manual for instructions on setting up a scan list and mapping the memory with RSNetworkx. Ensure that you are using the correct slot number. See the previous section for a mapping diagram. If you have only a single servo amplifier in the PLC scan list and the scanner is in slot 1, your input file mapping may look like this:

Input Word	Description
I:1.0	DN Scanner Status Word
I:1.1	DN response word 0 (control flags, block number)
I:1.2	DN response word 1 (command, response)
I:1.3	DN response word 2 (data LSW)
I:1.4	DN response word 3 (data MSW)
I:1.5-31	Unmapped area of DN scanner (available for other devices)

Once the inputs are mapped, you may read the latest Response Assembly received by the PLC by reading from the appropriate input file. The input files will be updated by the PLC on each scan cycle with data transmitted from the amplifier.

To test, use the output command assembly from the previous section. The example command assembly requests the actual position (Response Assembly Type = 1). After writing this command assembly to the output file, wait for the scan cycle to complete, then read the input file to get the latest response assembly. The response assembly should look something like the following, with the motor's actual position in bytes 4-7:

Byte	Function	Data value (hex)
0	Response Flags A – Disabled, In Position	0x04
1	Block Executing - none	0x00
2	Response flags B - load complete, no errors	0x80
3	Axis instance 1; Response assembly 1 - actual position	0x21
4	Actual position - lower word lower byte	0x00
5	Actual position - lower word upper byte	0x00
6	Actual position - upper word lower byte	0x00
7	Actual position - upper word upper byte	0x00

Mapping this to the PLC memory should look similar to the table shown below:

Input Word	Data Value (hex)
I:1.1	0000
I:1.2	2180
I:1.3	0000
I:1.4	0000

You can view the data easily in the Program Tags screen.

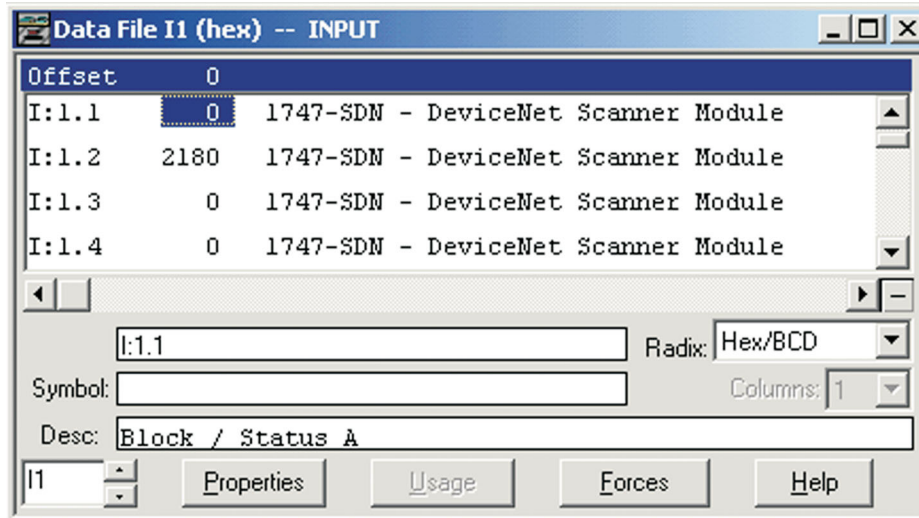



6.1.3.6 Data Handshaking - SLC500

Data handshaking is used to transmit data commands with Command Assemblies. To transmit a command to the amplifier, set the Command Type and load data into the data fields, then toggle the Load/Start bit high. The amplifier will accept data only when Load/Start transitions from 0 to 1. If the data is loaded successfully, the amplifier will set the Load Complete response flag high. Load Complete will be cleared by the amplifier after Load/Start is cleared by the controller. See the Data Handshaking section for more information.

The LoadData subroutine can be used to simplify data handshaking. The subroutine is shown below

To use LoadData, first copy a proper command assembly into I:1.1-4. Then set N47:0=1 and call the LoadData subroutine until N47:0 has been reset to 0.

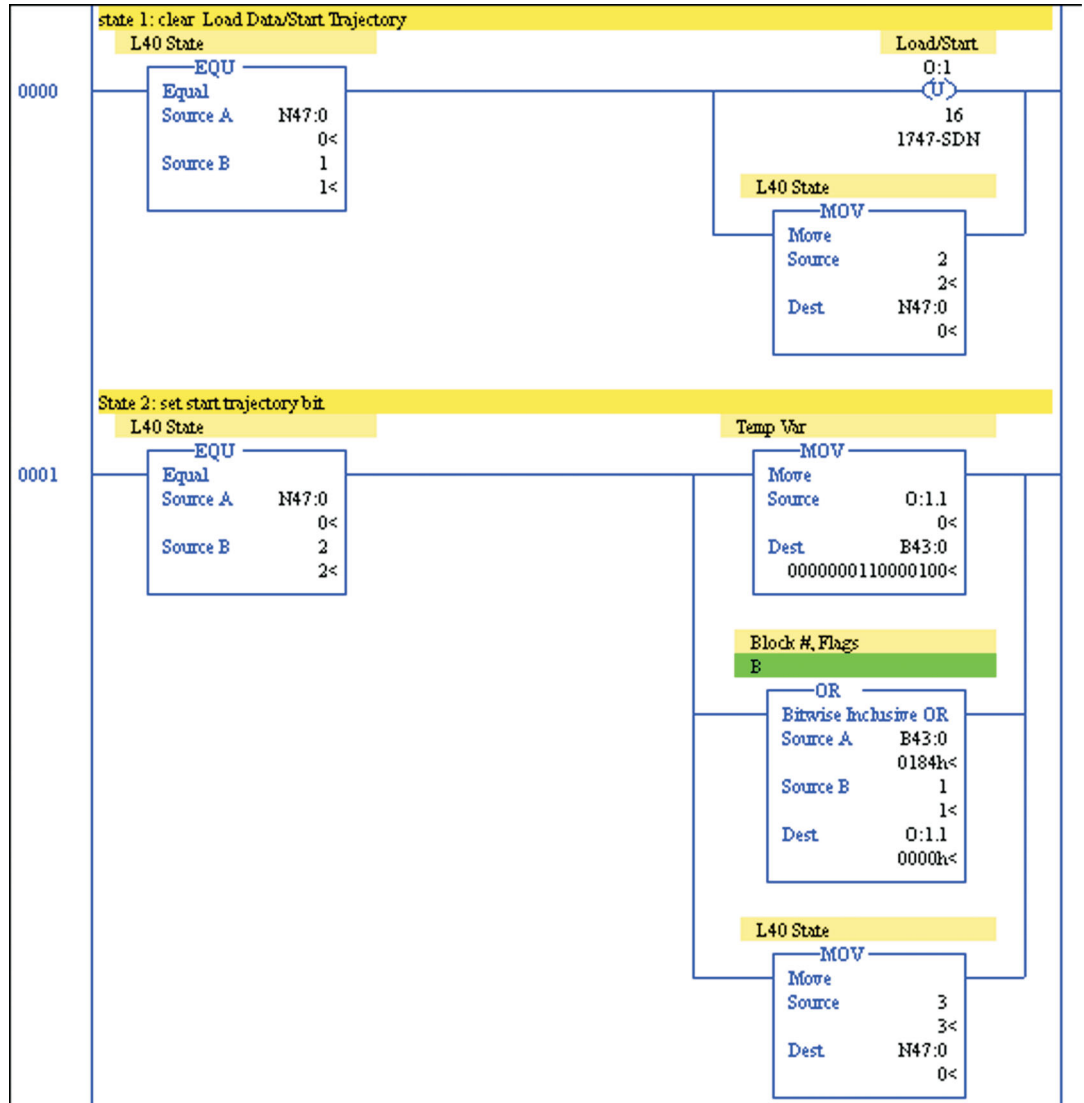

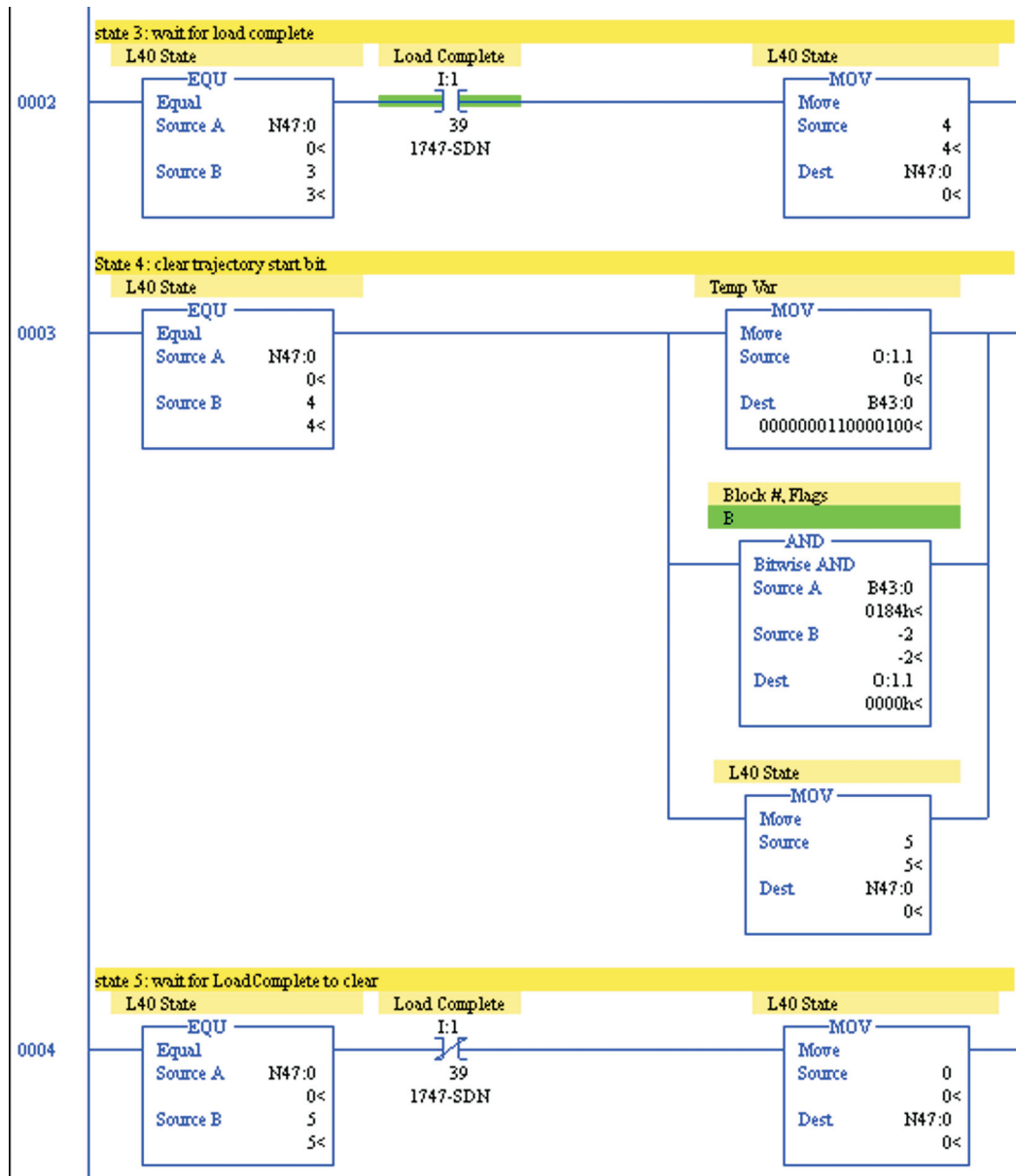

### 6.1.4 Explicit Messages

Explicit Messages are described thoroughly in the following sections: Typical Use of Explicit and Assembly Messages, Explicit Messages, Supported Services. See these sections for information on the structure and use of explicit messages.

Unlike Polled I/O Assembly Messages, Explicit Messages are sent only when explicitly requested by the PLC program. The servo amplifier will respond to each Explicit Message with either a success or error code.

### 6.1.4.1 Explicit Messages and ControlLogix

Use the ControlLogix message instruction MSG to transmit an explicit message to the servo amplifier.

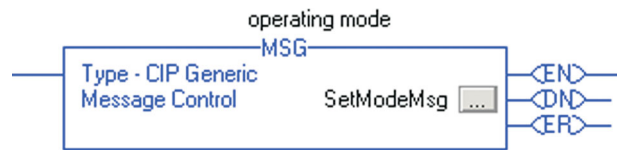

The tag used in the MSG block (SetModeMsg in the example figure) is of type MESSAGE and is configured by clicking the '...' button in the MSG block.

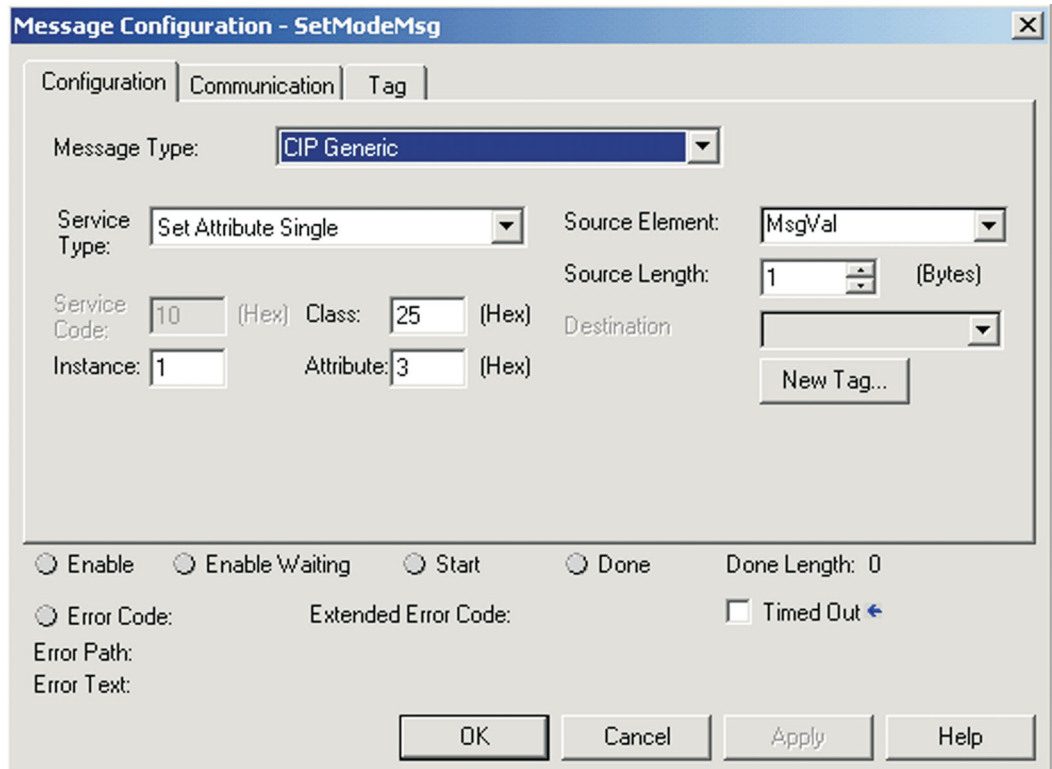

The Message Type for DeviceNet is 'CIP Generic'. The section 'Supported Services' describes the services available in the servo amplifier. Set Attribute Single and Get Attribute Single are the most commonly used services. Select the Class, Instance and Attribute values for the parameter you wish to set/get. These values are provided in the section 'Explicit Messages'. The example figure uses Class 0x25 – Position Controller Object, Instance 1 (only valid instance for the Position Controller Object), Attribute 3 (OpMode).

For a Set Attribute Single command, set Source Element to a variable holding the value you wish to transmit and Source Length to the byte count of the parameter. For a Get Attribute Single command, set Destination to the variable where you wish to store the parameter value.

Next, click on the Communication tab and enter the path to the servo amplifier. Click on Browse to find your scanner. The second element of the path will generally equal 2, referring to the external DeviceNet connection – read your scanner manual for more information. The third element is the node address (MACID) of the servo amplifier.

If any communication errors occur, the ER output from the MSG block will be set and the error code information will be printed on the bottom half of the message configuration screen. See the Error Messages section for further information.

### 6.1.4.2 Explicit Messages and SLC500

With a SLC500 processor, explicit messages are transmitted by writing to the M0 file and received by reading from the M1 file. If the scanner is in slot 1, the explicit message request structure is a 32-byte area in M0:1.224-255 and the explicit message response structure is a 32-byte area in M1:1.224-255. See your scanner manual for more information.

For this example, create a 32-byte output buffer and a 32-byte input buffer. Explicit Message requests are built in the output buffer, then copied to the M0 file. The response message in M1 is copied into the input buffer for further processing.

#### 6.1.4.2.1 SLC500 Explicit Message Request Structure

Byte 1	Byte 0	PLC output buffer	M0 Memory
TX_ID = 1	TX_CMD = 1,4	WORD 0	WORD 224
PORT= 0	MSG_SIZE (in bytes)	WORD 1	WORD 225
SERVICE	MAC ID (node address)	WORD 2	WORD 226
	CLASS	WORD 3	WORD 227
	INSTANCE	WORD 4	WORD 228
	ATTRIBUTE	WORD 5	WORD 229
	LOWER DATA WORD	WORD 6	WORD 230
	UPPER DATA WORD	WORD 7	WORD 231

**TX\_ID** The Transaction ID is an index into the scanner's explicit message queue. The scanner can queue messages to multiple devices and send them when it is able. For our purposes in this example, we always use Transaction ID 1.

**TX\_CMD** The Transaction Command to perform on the transaction block specified by TX\_ID.  
 01 Send Explicit Message.  
 04 Clear response buffer  
 (necessary before sending a new message with the same TX\_ID).

**PORT** 0 – Channel A. (typical choice)  
 1 – Channel B.

**MSG\_SIZE** Size in bytes of all data after the MAC ID (words 3-7). For a message which sets a boolean (1 byte) parameter, the message size will be 7; 2 bytes each for the class, instance and attribute plus 1 byte for the data value.

**SERVICE** The DeviceNet service to perform. See the section Supported Services for more information.  
 0x0E – Get.  
 0x10 – Set.

**MAC ID** The DeviceNet ID of the servo amplifier as specified by the two MACID switches.

#### NOTE

If the switches are set to 25 (the switches read as decimal), then this value is set to 19h.

**CLASS** DeviceNet class to access. Examples:  
 Parameter Object – 0x0F  
 Position Controller Supervisor – 0x24  
 Position Controller Object – 0x25

**INSTANCE** DeviceNet instance number. Examples:  
 Always 0x01 for Position Controller Object.  
 Parameter number (DPR number in ascii reference) for Parameter Object.  
 Port number for Analog and Digital I/O.

**ATTRIBUTE** The attribute number of the attribute being accessed (set or get).

**LOWER/UPPER DATA WORD** The data value for a Set service.

### 6.1.4.2.2 SLC500 Explicit Message Response Structure

Byte 1	Byte 0	PLC Input buffer	M1 Memory
TX_ID	TX_STATUS	WORD 0	WORD 224
PORT= 0	MSG_SIZE (in bytes)	WORD 1	WORD 225
SERVICE	MAC ID (in bytes)	WORD 2	WORD 226
DATA		WORD 3 - 31	WORD 227 - 255

**TX\_ID** Transaction ID. Matches the TX\_ID in the request message.

**TX\_STATUS** The Transaction Status for the transaction block specified by TX\_ID.  
 0 – Ignore block (empty)  
 1 – Transaction completed successfully  
 2-15 – Scanner error (see Scanner documentation)

**PORT** 0 – Channel A. (typical choice)  
 1 – Channel B.

**MSG\_SIZE** Size in bytes of all data after MAC ID (the data field).

**SERVICE** Echoes the service code from the command message, setting the upper bit for a response.  
 0x1E – Get.  
 0x90 - Set.  
 0x94 – DeviceNet Error. Error code follows in the Data section.

**MAC ID** The DeviceNet ID of the servo amplifier as specified by the two MACID switches.

**DATA** Response data (length in bytes given by MSG\_SIZE)

### 6.1.4.2.3 SLC500 Explicit Messaging Sequence

1. Create 32-byte request and response buffers. The example uses N11 for a request (output) buffer and N12 for a response (input) buffer.
2. Clear the scanner transaction block which you wish to use (selected with the TX\_ID field) by loading TX\_CMD 0x04 (clear response buffer). For example, to clear transaction block 1, set TX\_ID=0x01 and TX\_CMD=0x04 in the output buffer (WORD 0 = 0x0104), then copy the request buffer into M0:1.224-255.
3. Build an Explicit Message Request in the output buffer. Set TX\_ID=0x01 to use transaction block 1 and set TX\_CMD=0x01 (transmit explicit message). Use the file copy instruction (COP) to copy the data into M0:1.224-2554
4. Wait until the Explicit Message Response Available bit transitions to 1, indicating that an explicit response message has been received. The flag is bit 15 of the 1747-SDN Module Status Register (typically mapped to word 0 of the input file so the bit is I:1/155)
5. Use the file copy instruction (COP) to copy the data from M1:1.224-255 into the response buffer
6. Test the TX\_ID field to make sure it matches the TX\_ID set in the request message. Test the TX\_STATUS value for an error (1 = success). Test the SERVICE value for a DeviceNet error code (0x94 indicates an error).
7. Clear the scanner transaction block by loading TX\_CMD=0x04 into the request buffer and copying the buffer into M0:1.224-255. After the data is loaded, the Explicit Message Response Available bit should transition to 0.
8. Send the next Explicit Request Message by continuing at step 3.

Note: SLC500 PLC's sometimes take up to 2 seconds to process an explicit message command. This delay is not controlled by the S600 in any way, as it responds to an explicit message command in less than 5 ms.

6.1.4.2.4 SLC500 Explicit Messaging Example Code

The SLC500 example program includes the subroutine EXP\_MSG to handle most of the explicit messaging sequence. To use the subroutine, simply build an Explicit Request Message in the request buffer N11. Ignore WORD 0 (TX\_ID and TX\_CMD) as this is controlled by the subroutine. Set N13:0 = 1 to start the EXP\_MSG state machine. N13:0 is reset to 0 after the response message has been loaded into the response buffer and the subroutine has completed.

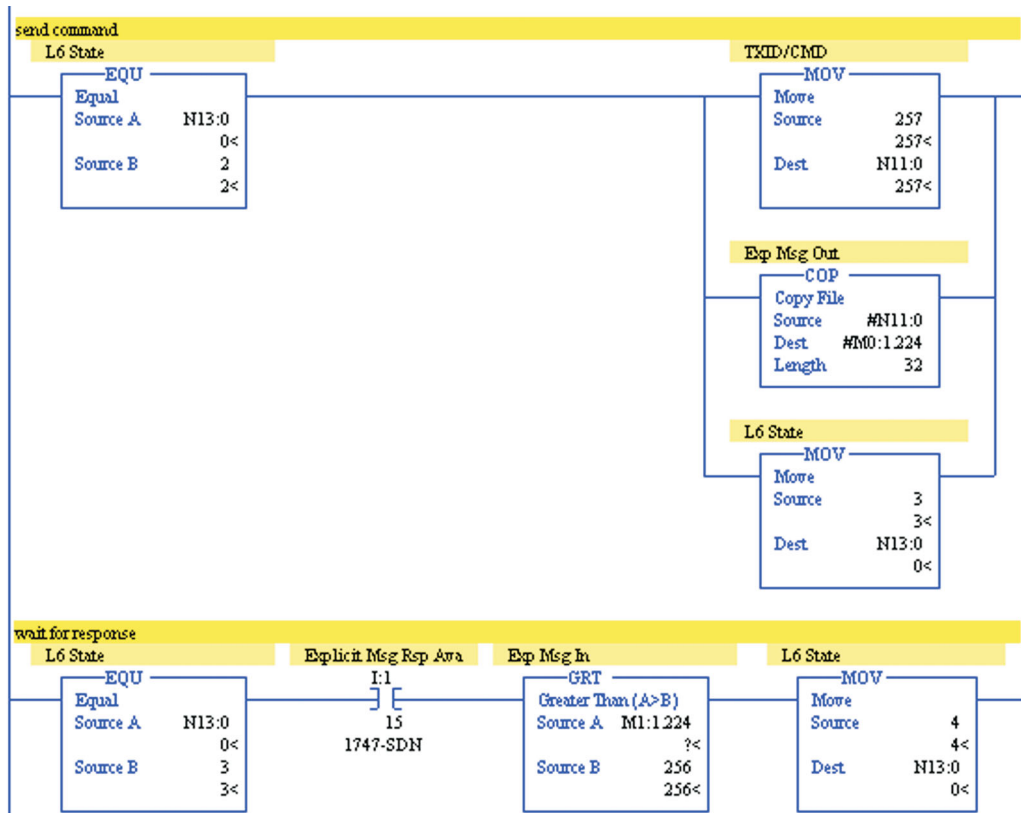
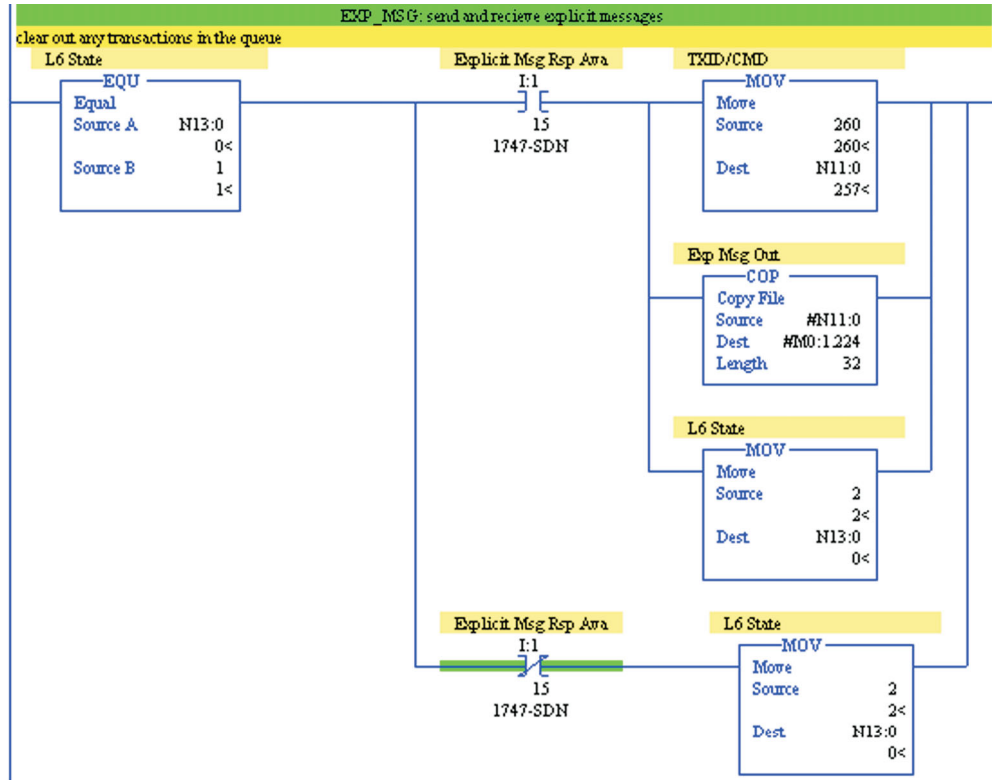

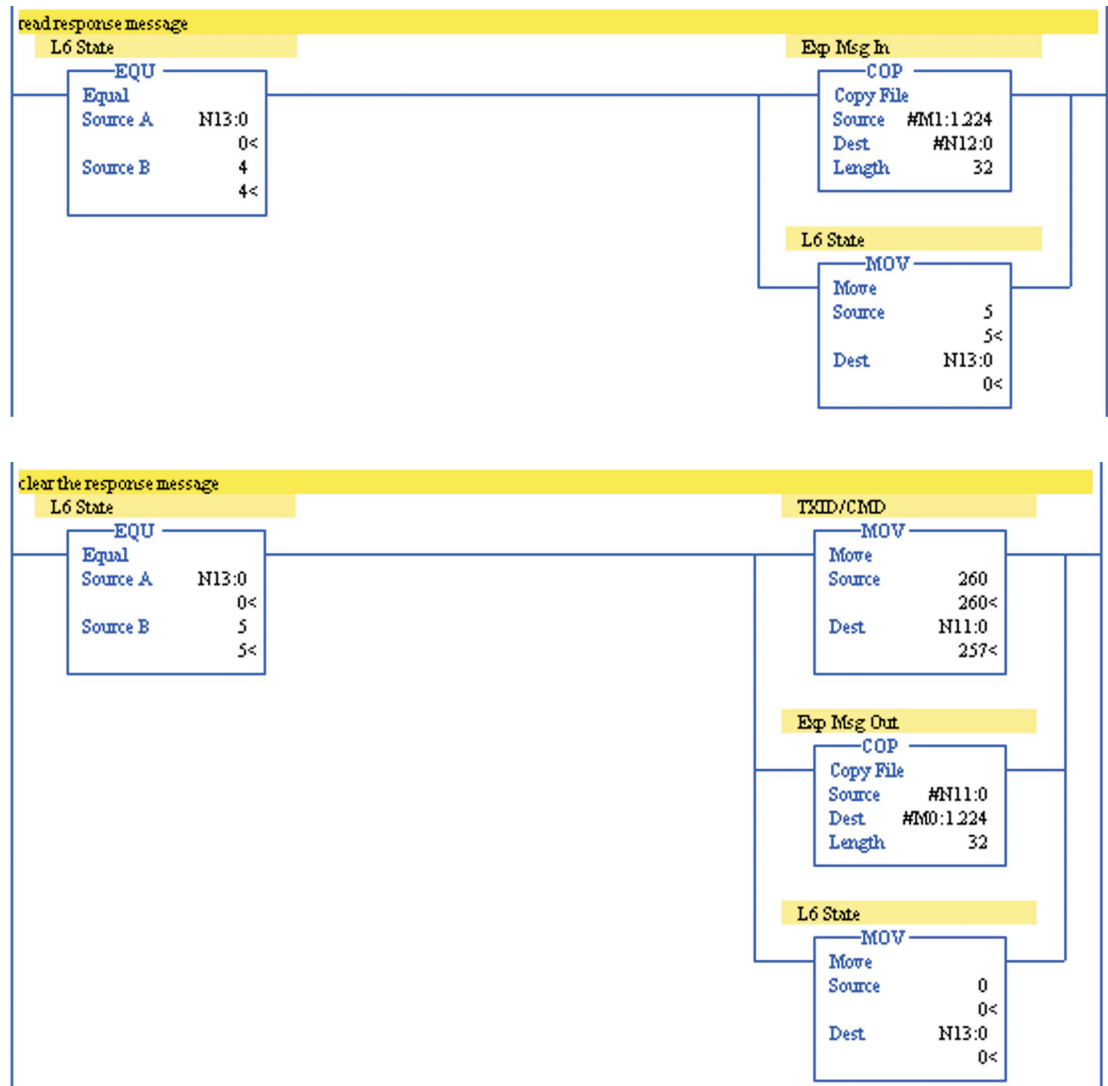

### 6.1.5 Example 1: Simple Move

This example performs a simple operation, consisting of the following tasks:

- 1) Select positioning mode
- 2) Enable the servo amplifier
- 3) Home
- 4) Move one revolution
- 5) Wait until movement is complete
- 6) Set digital output 1 on
- 7) Delay 2 seconds
- 8) Set digital output 1 off
- 9) Move back ½ revolution

### 6.1.5.1 Serial Command Sequence

This example may be executed manually from the serial terminal window in the amplifier setup software with the following commands:

Command	Description
OPMODE 8	Switch to position mode
EN	Enable the S600
MH	Move home
ACCR 10	acceleration time = 10ms
DECR 10	deceleration time = 10ms
O_V 60	target velocity = 60 RPM
O_P 1000	target position = 1000 counts (1 revolution)
O_C 10240	command word = 0x2800 - user units for position and velocity; absolute move; interpret O_C2
O_C2 256	secondary command word = 0x100 - use ACCR and DECR for this motion task
MOVE 0	Execute motion task 0 (wait for move to complete)
O1 1	Set digital output 1 high (wait 2 seconds for desired delay)
O1 0	Set digital output 1 low
O_P 500	Set the target position to 500 counts (½ revolution)
MOVE 0	Execute motion task 0

Test the example manually before continuing to ensure that the servo amplifier is configured properly.



## 6.1.5.2 DeviceNet Command Sequence

DeviceNet Command	Serial Terminal Verification
<p><i>Set OpMode = Position_Mode</i>            Explicit Msg Request: Service = 0x10, Class = 0x25, Instance=0x01, Attribute = 0x03, Data = 0x00</p>	OPMODE 8
<p><i>Enable the amplifier</i>            Polled I/O Command Assembly: set the Enable flag = 1 (byte 0, bit 7)            Word 0 = 0x2020_0080            Word 1 = 0x0000_0000</p>	READY 1
<p><i>Move Home</i>            Explicit Msg Request: Service = 0x10, Class = 0x0F, Instance = 141 (MH command in the ascii reference), Attribute = 0x01, Data = 0x01</p>	DRVSTAT bit 0x2000 is set
<p><i>Wait Until Homed – Read Amplifier Status Word</i>            Explicit Msg Request: Service 0x0E, Class 0x25, Instance = 0x01, Attribute = 0x66</p>	Home has completed
<p><i>Set Acceleration Rate = 10</i>            Polled I/O Command Assembly: use command 0x03            Word 0 = 0x2023_0080            Word 1 = 0x0000_000A            Toggle bit 0 high to load (Data Handshaking)</p>	ACCR 10
<p><i>Set Deceleration Rate = 10</i>            Polled I/O Command Assembly: use command 0x04            Word 0 = 0x2024_0080            Word 1 = 0x0000_000A            Toggle bit 0 high to load (Data Handshaking)</p>	DECR 10
<p><i>Set Target Velocity = 60</i>            Polled I/O Command Assembly: use command 0x02            Word 0 = 0x2022_0080            Word 1 = 0x0000_003C            Toggle bit 0 high to load (Data Handshaking)</p>	O_V 60
<p><i>Set Target Position = 1000</i>            Polled I/O Command Assembly: use command 0x01            Word 0 = 0x2021_0080            Word 1 = 0x0000_03E8            Toggle bit 0 high to load and begin motion (Data Handshaking).</p>	O_P 1000 O_C 10240 = 0x2800 (user units, 1 revolution)
<p>Watch the Response Assembly – In Motion flag (byte 0, bit 0).            Wait until this bit transitions low (indicating that the move has completed).</p>	The In Motion flag should be high whenever the drive is in motion.
<p><i>Set Digital Output 1 On</i>            Explicit Msg Request: Service = 0x10, Class = 0x09, Instance = 0x01 (for output 1), Attribute = 0x03, Data = 0x01</p>	O1 1
<p><i>Delay 2 seconds</i></p>	(Set PLC timer to delay for 2 seconds)
<p><i>Set Digital Output 1 Off</i>            Explicit Msg Request: Service = 0x10, Class = 0x09, Instance = 0x01 (for output 1), Attribute = 0x03, Data = 0x00</p>	O1 0
<p><i>Set Target Position = 500</i>            Polled I/O Command Assembly: use command 0x01            Word 0 = 0x2021_0080            Word 1 = 0x0000_01F4            Toggle bit 0 high to load and begin motion (Data Handshaking).</p>	O_P 500 O_C 10240 = 0x2800 (user units, - ½ revolution)

### 6.1.5.3 ControlLogix program

A ControlLogix program called S600\_Example\_1.ACD which implements this example is available from the website. The example assumes that a DeviceNet scanner is installed in slot 1 and that an servo amplifier at address 1 is mapped into the lowest words of the scanner.

To begin the example sequence, configure the amplifier as described in the section 'Amplifier Setup for the Examples', download the program to the processor, enter run mode, and set Ex1State=1.

### 6.1.5.4 SLC500 program

A SLC500 program called S600\_Example\_1.RSS which implements this example is available from the website. The example assumes that a DeviceNet scanner is installed in slot 1 and that an servo amplifier at address 1 is mapped into the lowest words of the scanner.

To begin the example sequence, configure the amplifier as described in the section 'Amplifier Setup for the Examples', download the program to the processor, enter run mode, and set Ex1State (N16:0) = 1.

## 6.2 Baud Rate Switch Settings

For servoamplifiers, the baud rate switch may be set to 0 (125 Kbaud), 1 (250 Kbaud) or 2 (500 Kbaud). If the switch is set to a value greater than 2, the baud rate is configurable through the terminal parameter DNBAUD and through DeviceNet. If the switch is set from 0 to 2, the baud rate cannot be controlled with DNBAUD or DeviceNet.

## 6.3 MAC ID Switch Configuration

Values 0 to 63 are valid. If the switches are set to a value greater than 63, the MAC ID is configurable through the terminal parameter DNMACID and through DeviceNet. If the switches are set from 0 to 63, the MAC ID cannot be controlled with DNMACID or DeviceNet.

## 6.4 Network LED

The Network LED indicates the status of this device on the DeviceNet network.

Device state	LED	Details
Not powered / not online	off	Device is not on-line. Either network power is off or the device has not completed the Dup_MAC_ID test
Online, not connected	flashing green	Device is on-line but has no connections in the established state. The device has passed the Dup_MAC_ID test, is on-line, but has no established connections to other nodes. This device is not allocated to a master.
Online, connected	green	The device is on-line and has connections in the established state. The device is allocated to a Master.
Connection time-out	flashing red	The Polled I/O connection is in the timed-out state.
Critical link failure	red	The device has detected an error that has rendered it incapable of communicating on the network (Duplicate MAC ID, or Bus-off).

## 6.5 Listing of DeviceNet Commands

This appendix cross-references DeviceNet messages (both Explicit Message class/instance/attribute mappings and Polled I/O Command/Response fields) to serial terminal commands. For information of each serial command, look for the matching section in ascii.chm.

## 6.5.1 Data Types

Type	Description	Width (bytes)	Min	Max
BOOL	Boolean	1		
SINT	Short Integer	1	-128	127
BYTE	bit string - 8 bits	1		
USINT	Unsigned Short Integer	1	0	255
INT	Integer	2	-32768	32767
UINT	Unsigned Integer	2	0	65535
WORD	bit string - 16-bits	2		
DINT	Double Integer	4	-2 <sup>31</sup>	2 <sup>31</sup> -1
UDINT	Unsigned Double Integer	4	0	2 <sup>32</sup> -1
DWORD	bit string - 32-bits	4		
LINT	Long Integer	8	-2 <sup>63</sup>	2 <sup>63</sup> -1
ULINT	Unsigned Long Integer	8	0	2 <sup>64</sup> -1
LWORD	bit string - 64-bits	8		
EPATH	DeviceNet path segments	variable		

## 6.5.2 Explicit Messages

Services: Reset=0x05, Get=0x0E, Set=0x10

Classes: 0x01=Identity Object, 0x24=Position Controller Supervisor, 0x25=Position Controller Object, 0x26=Block Sequencer, 0x27=Command Block, 0x0F=Parameter Object

Name	Cls	Inst	Attr	Srv	Data	Notes
<b>Identity Object</b>						
Reset	0x01	0x01	0x00	R	none	Set value=1 to restart the amplifier. COLDSTART.
Default	0x01	0x01	0x01	R	none	Set value=1 to load default parameters and restart. RSTVAR, SAVE, COLDSTART.
Serial Number	0x01	0x01	0x06	G	UDINT	SERIALNO
<b>Position Controller Supervisor Object</b>						
General Fault	0x24	0x01	0x05	G	BOOL	=1 if any amplifier faults (ERRCODE). Also set on warnings for n3 (position error), n8 (bad motion task), n9 (reference point not set)
Clear Faults	0x24	0x01	0x65	G/S	BOOL	Set value=1 to clear faults. CLRFAULT.
Error Code	0x24	0x01	0x64	G	DINT	ERRCODE. Returns the hex value of the error code.
<b>Position Controller Object</b>						
Mode	0x25	0x01	0x03	G/S	USINT	0=Position (OPMODE 8). 1= velocity (OPMODE 0). 2=Torque (OPMODE 2).
Target Position	0x25	0x01	0x06	G/S	DINT	O_P. Sets O_C bits 0x2800 and O_C2 bits 0x100, units are SI and ACCR/DECR override O_ACC1/O_DEC1.
Target Velocity	0x25	0x01	0x07	G/S	DINT	O_V. Units determined by amplifier configuration.
Acc	0x25	0x01	0x08	G/S	DINT	Velocity Mode: ACC. Position Mode: ACCR. Units set by ACCUNIT,PGEARI.
Dec	0x25	0x01	0x09	G/S	DINT	Velocity Mode: DEC. Position Mode: DECR. Units set by ACCUNIT,PGEARI.
Incremental Flag	0x25	0x01	0x0a	G/S	BOOL	O_C bit 0. 0->ABS, 1->INCR.
Load/Profile Handshake	0x25	0x01	0x0b	G/S	BOOL	Get: 1 if in motion. Set 1 to move (type depends on Mode - attr 3).
in position	0x25	0x01	0x0c	G	BOOL	INPOS
Actual Position	0x25	0x01	0x0d	G/S	DINT	Get: read current position (PFB). Set: redefine position. ROFFS=X, NREF=0, MH
Actual Velocity	0x25	0x01	0x0e	G	DINT	abs(PV)
Enable	0x25	0x01	0x11	G/S	BOOL	EN
Smooth Stop	0x25	0x01	0x14	G/S	BOOL	STOP. DECR is rate. Get returns 0.
Hard Stop	0x25	0x01	0x15	G/S	BOOL	Emergency stop. DECSTOP is rate. Get returns 0.

Name	Cls	Inst	Attr	Srvc	Data	Notes
Jog Velocity	0x25	0x01	0x16	G/S	DINT	J. Positive value – direction depends on Direction attr23 Units determined by amplifier configuration. Used only in Velocity Mode.
Direction	0x25	0x01	0x17	G/S	BOOL	Get: current direction of motion (not the flag). S: direction flag for J. 1->pos direction. 0->neg direction
Reference Direction	0x25	0x01	0x18	G/S	BOOL	DIR (inverse). 1=pos, 0=neg (0 -> CW is positive). Can only set when amplifier is disabled. You must save and restart the amplifier after setting this variable.
Torque	0x25	0x01	0x19	G/S	DINT	New torque value (set Load bit - attr 11 - to move). Internal counts. 3280 = peak torque. Similar to the T command, except the new torque command isn't executed until the Load bit is set.
Save parameters	0x25	0x01	0x65	G/S	BOOL	SAVE. Write 1 to save parameters to EPROM. Get returns 0.
Drive Status	0x25	0x01	0x66	G	DINT	DRVSTAT
Trajectory Status	0x25	0x01	0x67	G	DINT	TRJSTAT
<b>Block Sequencer Object</b>						
Block	0x26	0x01	0x01	G/S	USINT	1-255. Block number to execute (ORDER# for MOVE <sub>x</sub> ).
Block Execute	0x26	0x01	0x02	G/S	BOOL	Set to begin block execution. Reads 1 while executing a block and 0 when complete. MOVE <sub>x</sub> .
Current Block	0x26	0x01	0x03	G/S	USINT	Number of currently executing block. Reads 0 on jog. TASKNUM.
Block Fault	0x26	0x01	0x04	G/S	BOOL	Set when a block error occurs. Reset when Block Fault Code is read.
Block Fault Code	0x26	0x01	0x05	G/S	BOOL	0=no fault, 1 = invalid or empty block data, 2 = command time out (Wait Equals), 3 = execution fault.
Counter	0x26	0x01	0x06	G/S	DINT	(positive) counter for block looping. M LOOPCNT.
<b>Command Block Object (all)</b>						
Block Type	0x27	0x01-0xff	0x01	G/S	USINT	Command to execute, e.g. 0x01=Modify Attribute (see following sections). The value of Block Command determines the format of attributes 3-7. The block command is stored in the 2 low bytes of O_C2 (see following sections for mapping of Block Command value into O_C2). For motion tasks, bit 0x100 in O_C2 is set so that ACCR and DECR are used for the acceleration and deceleration rates. Setting the block command also modifies O_C - sets 0x800 (extended task type bit) for most tasks and 0x2800 for motion tasks.
Block Link #	0x27	0x01-0xff	0x02	G/S	USINT	O_FN - Instance number of the next block to execute when this block is done. 0 means no following task.
<b>Command Block Object (with Block Command=1 Modify Attribute)</b>						
Modify Attribute - set the value of any DeviceNet accessible attribute. Setting Block Command (attribute 1) = Modify Attribute will also set O_C bit 0x800 and O_C2=6.						
Class	0x27	0x01-0xff	0x03	G/S	USINT	Class to access (e.g. 0x25 for Position Controller Object). Stored in the upper byte of O_ACC1.
Instance	0x27	0x01-0xff	0x04	G/S	USINT	Instance to access. Stored in O_DEC1.
Attribute	0x27	0x01-0xff	0x05	G/S	USINT	Attribute to access (must be settable). Stored in the lower byte of O_ACC1.
Data	0x27	0x01-0xff	0x06	G/S	DINT	New attribute data. Stored in O_P.
<b>Command Block Object (with Block Command=2 Wait for Parameter Value)</b>						
Wait for parameter value - delay until a DeviceNet accessible attribute equals a desired value. Setting Block Command (attribute 1) = 2 will also set O_C bits 0x880 and O_C2=2.						
Class	0x27	0x01-0xff	0x03	G/S	USINT	Class to access (e.g. 0x25 for Position Controller Object). Stored in the upper byte of O_ACC1.
Instance	0x27	0x01-0xff	0x04	G/S	USINT	Instance to access. Stored in O_DEC1.
Attribute	0x27	0x01-0xff	0x05	G/S	USINT	Attribute to access (must be settable). Stored in the lower byte of O_ACC1.

Name	Cls	Inst	Attr	Srvc	Data	Notes
Time-out	0x27	0x01-0xff	0x06	G/S	DINT	Maximum time to wait in ms. Fault if time-out is reached. 0 = no timeout. Stored in O_FT.
Compare Data	0x27	0x01-0xff	0x07	G/S	DINT	Value to wait for. Stored in O_P.
<b>Command Block Object (with Block Command=3 Greater-Than Test)</b>						
Greater-than test - Test the value of a DeviceNet accessible attribute and branch to an alternate block if the attribute value is greater than the test value. Setting Block Command (attribute 1) = 3 will also set O_C bit 0x800 and O_C2=3.						
Class	0x27	0x01-0xff	0x03	G/S	USINT	Class to access (e.g. 0x25 for Position Controller Object). Stored in the upper byte of O_ACC1.
Instance	0x27	0x01-0xff	0x04	G/S	USINT	Instance to access. Stored in O_DEC1.
Attribute	0x27	0x01-0xff	0x05	G/S	USINT	Attribute to access (must be settable). Stored in the lower byte of O_ACC1.
Alternate Link Number	0x27	0x01-0xff	0x06	G/S	USINT	Block to branch to if true. Stored in O_DEC2.
Compare Data	0x27	0x01-0xff	0x07	G/S	DINT	If the Attribute is greater than Compare Data, ignore the normal link (attribute 2) and branch to Alternative Link (attribute 6). Stored in O_P.
<b>Command Block Object (with Block Command=4 Less-Than Test)</b>						
Less-than test - Test the value of a DeviceNet accessible attribute and branch to an alternate block if the attribute value is less than the test value. Setting Block Command (attribute 1) = 4 will also set O_C bit 0x800 and O_C2=4.						
Class	0x27	0x01-0xff	0x03	G/S	USINT	Class to access (e.g. 0x25 for Position Controller Object). Stored in the upper byte of O_ACC1.
Instance	0x27	0x01-0xff	0x04	G/S	USINT	Instance to access. Stored in O_DEC1.
Attribute	0x27	0x01-0xff	0x05	G/S	USINT	Attribute to access (must be settable). Stored in the lower byte of O_ACC1.
Alternate Link Number	0x27	0x01-0xff	0x06	G/S	USINT	Block to branch to if true. Stored in O_DEC2.
Compare Data	0x27	0x01-0xff	0x07	G/S	DINT	If the Attribute is less than Compare Data, ignore the normal link (attribute 2) and branch to Alternative Link (attribute 6). Stored in O_P.
<b>Command Block Object (with Block Command=5 Decrement Counter)</b>						
Decrement Counter - This block decrements the global counter in the Command Block Sequencer object. No additional attributes are defined for this command type. Setting Block Command (attribute 1) = 5 will also set O_C bit 0x800 and O_C2=9.						
<b>Command Block Object (with Block Command=6 Delay)</b>						
Delay - This block causes the sequencer to delay for a given number of milliseconds before continuing with the next block. The block must have a Block Link in attribute 2. Setting Block Command=6 will also set O_C bits 0x880 and O_C2=1.						
Delay	0x27	0x01-0xff	0x03	G/S	DINT	Time to delay in ms. Stored in O_FT.
<b>Command Block Object (with Block Command=8 Trajectory)</b>						
Trajectory - execute a positioning move. Setting Block Command=8 will also set O_C bit 0x3800 (SI units, extended task) and O_C2=0x100 (use global acceleration and deceleration rates).						
Target Position	0x27	0x01-0xff	0x03	G/S	DINT	O_P
Target Velocity	0x27	0x01-0xff	0x04	G/S	DINT	O_V
Incremental	0x27	0x01-0xff	0x05	G/S	BOOL	O_C bit 0. 0->absolute move, 1->incremental move.
<b>Command Block Object (with Block Command=9 Velocity Change)</b>						
Velocity Change - execute a velocity profile. Setting Block Command=9 will also set O_C2=0x165 and O_C bits 0x3800. This type of block cannot have a next block link since the velocity profile doesn't have a definite end.						
Target Velocity	0x27	0x01-0xff	0x03	G/S	DINT	O_V
<b>Parameter Object</b>						
The instance number in the parameter object corresponds to the DPR number specified in the ASCII serial-terminal command reference for drive parameters. Only parameters 1-255 are accessible.						
Parameter Value	0x0F	0x01-0xFF	0x01	G/S	type	Actual value of the parameter. The value is read-only if bit 4 of attr#4 (descriptor-ReadOnly bit) is 1.
Descriptor	0x0F	0x01-0xFF	0x04	G	WORD	Read-only if bit 0x10 is set.
Data Size	0x0F	0x01-0xFF	0x06	G	USINT	Length of the data in bytes.

Name	Cls	Inst	Attr	Srvc	Data	Notes
<b>Discrete Input Point Object</b>						
Value	0x08	0x01-0x04	0x03	G	BOOL	0=off; 1=on. Instance 1-4 → IN1, IN2, IN3, IN4. These are the onboard digital input available on connector X3.
<b>Discrete Output Point Object</b>						
Value	0x09	0x01-0x02	0x03	S	BOOL	0=off; 1=on. Settable only if O1MODE=23 / O2MODE=23, else returns error 0x10 Device Conflict. Is reset to 0 on any fault. Instance 1,2 → O1, O2.
<b>Analog Input Point Object</b>						
Value	0x0A	0x01-0x02	0x03	G	INT	Voltage on the input, in mV. Instance 1,2 → ANIN1, ANIN2.
<b>Analog Output Point Object</b>						
Value	0x0B	0x01-0x02	0x03	S	INT	Instance 1,2 → AN1TRIG,AN2TRIG. Set ANOUT1/2 = 6 for DeviceNet control. Value is the voltage to output in mV. If ANOUT1/2 6, returns error 0x10 Device Conflict.

## 6.5.3

## Polled I/O Messages

Name	Byte	Bit	Value	Notes
<b>Command Assembly</b>				
Load Data/Start Profile	0	0	0/1	To load data into the amplifier, set the Command Type and Data fields, then transition this bit 0->1 to initiate data hand-shaking. If the command is accepted, the amplifier will set the Data Loaded bit in the response assembly. If the command type matches the amplifier mode, movement will start (Position command in position mode, Torque command in torque mode, Velocity command in velocity mode).
Start Block	0	1	0/1	Transition 0->1 to execute a Command Block or chain. The Block Number is in byte 1 of the command assembly. Similar to MH [BlockNumber]
Incremental	0	2	0/1	O_C bit 0. 0 = absolute position. 1 = incremental. (Positioning mode only)
Direction	0	3	0/1	Controls direction of the motor in velocity mode. 1 = forward, 0 = reverse. Only valid in velocity mode.
Smooth Stop	0	4	0/1	STOP. Immediate controlled stop. Uses DECR for rate.
Hard Stop	0	5	0/1	DECSTOP. Immediate fast stop
Reg Arm	0	6	0/1	Registration Arm.
Enable	0	7	0/1	EN. 1 = enable the amplifier. 0 = disable and stop motion.
Block Number	1	1-7	0-255	Block number to execute on a positive Start Block edge. MOVE [BlockNumber]
Command Type	2	0-4	0-5	command types follow. Set Load Data/Start Trajectory bit to load the command.
x00 No Operation	2	0-4	0	do nothing
x01 Target Position	2	0-4	1	O_P. Move will begin when this command is loaded in positioning mode.
x02 Target Velocity	2	0-4	2	position mode: O_V. velocity mode: J and move will begin when this command is loaded.
x03 Acceleration	2	0-4	3	Velocity Mode: ACC. Position Mode: ACCR. Units set by AC-CUNIT,PGEARI.
x04 Deceleration	2	0-4	4	Velocity Mode: DEC. Position Mode: DECR. Units set by AC-CUNIT,PGEARI.
x05 Torque	2	0-4	5	T. Only works in torque mode.
Command Axis	2	5-7	1	This must always be 1. Any other value will invalidate the command assembly.
Response Type	3	0-4	0-3,5,0x14	Response types follow. The response data will be in the next response assembly.
x00 No Operation	3	0-4	0	do nothing. Response data will be zeros.

Name	Byte	Bit	Value	Notes
x01 Actual Position	3	0-4	1	PFB
x02 Commanded Position	3	0-4	2	PTARGET
x03 Actual Velocity	3	0-4	3	abs(PV). Steps/s. Absolute value of velocity.
x05 Torque	3	0-4	5	I
x14 Assembly Error	3	0-4	0x14	Error code in response assembly: bytes 4-5=error code, 6-7=mirror command bytes 2-3. ERROR CODES... Less than 8 bytes: x13 ff. Unsupported command: x08 01. Unsupported Response: x08 02. Unsupported command axis: x05 01. Unsupported response axis: x05 02. Get unsupported attribute: x14 02. Set unsupported attribute: x14 01. Set unsettable attribute: x0E FF. Set invalid value: x09 FF.
Response Axis	3	5-7	1	This must always be 1. Any other value will invalidate the command assembly.
Command Data	4-7			Data depends on Command Type. Data bytes are in reverse order - the least significant byte is first.
<b>Response Assembly</b>				
Profile in progress	0	0	0/1	1 = a move has been commanded and is not complete. DRVSTAT bit 0x10000
Block in execution	0	1	0/1	1 = a block is in execution. Block number given in byte 1.
in position	0	2	0/1	INPOS. 1 = in position
General Fault	0	3	0/1	1 = alarm. Faults, Warnings n3, n8, n9. ERRCODE.
Current Direction	0	4	0/1	Current Direction. 1 = Fwd. V positive or negative.
Home Flag	0	5	0/1	1=off the flag, 0=on the flag. Level of home input. DRVSTAT bit 0x40000
Reg Level	0	6	0/1	Registration input level. IN2MODE must = 26
Enable	0	7	0/1	1 = enabled. READY.
Executing Block #	1	0-7	0-255	Block currently in execution. 0=no block executing. TASKNUM.
Fault Input	2	0	0/1	1 = Fault Input is active. Using Emergency Stop inputs. Check for input with INxMODE=27 and input level low (active level low is fault).
Positive HW Limit	2	1	0/1	DRVSTAT bit 0x200. 1=active.
Negative HW Limit	2	2	0/1	DRVSTAT bit 0x400. 1=active.
Positive Software Limit	2	3	0/1	DRVSTAT bit 0x40. 1=active
Negative Software Limit	2	4	0/1	DRVSTAT bit 0x20. 1=active
Following Error	2	5	0/1	Following Error. DRVSTAT bit 0x04.
Block Fault	2	6	0/1	Error executing a block. 1 = Fault. Read Block Sequencer Object attr#5 to clear.
Load Complete	2	7	0/1	Load Complete. Command data loaded successfully. Reset when Load/Start bit is low.
Response Type	3	0-4	0-3,5,0x14	Echoes Response Type from Command Assembly. See description above.
Response Axis	3	5-7	1	Echoes Response Axis from Command Assembly.
Response Data	4-7			Data depends on Response Type. Data bytes are in reverse order - the least significant byte is first.

## 6.6

### Default Input/Output Configuration

For the servo amplifier, the following input configuration is applicable:

- O1MODE=23 (DeviceNet control of digital output 1)
- O2MODE=23 (DeviceNet control of digital output 2)
- ANOUT1=6 (DeviceNet control of analog output 1)
- ANOUT1=6 (DeviceNet control of analog output 1)

## 6.7 Error Messages

DeviceNet error messages are received when a command assembly or explicit request message cannot be handled successfully by the amplifier. This is often caused by either an invalid message or an invalid amplifier state.

The servo amplifier transmits an error response assembly in reply to a bad command assembly. Response type 0x14 is loaded in the Response Assembly Type field and the error codes are loaded in bytes 4-5. See section 5.2.6 for more information.

The servo amplifier will transmit an error explicit response message in reply to a bad explicit request message. This response will have service code 0x94 and the error codes in the first two data bytes.

Error Code (hex)	Additional Code (hex)	DeviceNet Error
0	FF	NO_ERROR
2	FF	RESOURCE_UNAVAILABLE
5	FF	PATH_UNKNOWN
5	1	COMMAND_AXIS_INVALID
5	2	RESPONSE_AXIS_INVALID
8	FF	SERVICE_NOT_SUPP
8	1	COMMAND_NOT_SUPPORTED
8	2	RESPONSE_NOT_SUPPORTED
9	FF	INVALID_ATTRIBUTE_VALUE
B	FF	ALREADY_IN_STATE
C	FF	OBJ_STATE_CONFLICT
D	FF	OBJECT_ALREADY_EXISTS
E	FF	ATTRIBUTE_NOT_SETTABLE
F	FF	ACCESS_DENIED
10	FF	DEVICE_STATE_CONFLICT
11	FF	REPLY_DATA_TOO_LARGE
13	FF	NOT_ENOUGH_DATA
14	FF	ATTRIBUTE_NOT_SUPP
15	FF	TOO_MUCH_DATA
16	FF	OBJECT_DOES_NOT_EXIST
17	FF	FRAGMENTATION_SEQ_ERR
20	FF	INVALID_PARAMETER



## 6.8 Index

<b>A</b>	Abbreviations . . . . .	9	<b>P</b>	Polled I/O . . . . .	55
	Additional documentation . . . . .	7		Position controller . . . . .	19
<b>B</b>	Basic features . . . . .	10		Positioning functions . . . . .	10
<b>C</b>	Communication faults . . . . .	17	<b>S</b>	Setup . . . . .	16
<b>D</b>	Data transfer functions . . . . .	10		Setup functions . . . . .	10
	Data types . . . . .	23		Supervisor attributes . . . . .	25
	DeviceNet bus cable . . . . .	13		Symbols . . . . .	8
<b>E</b>	Error codes . . . . .	25		System requirements . . . . .	8
<b>I</b>	I/O response . . . . .	66	<b>T</b>	Target group . . . . .	7
	Installation . . . . .	11		Transmission procedure . . . . .	10
<b>M</b>	Motion objects . . . . .	20		Transmission rate . . . . .	10
<b>O</b>	Object class		<b>U</b>	Use as directed . . . . .	8
	Block sequencer . . . . .	35			
	Command block . . . . .	37			
	Connection (explicit) . . . . .	53			
	Connection (polled I/O) . . . . .	54			
	DeviceNet . . . . .	52			
	Identity . . . . .	51			
	Message router . . . . .	52			
	Position controller . . . . .	27			
	Position controller supervisor . . . . .	25			

## Service

We are committed to quality customer service. In order to serve in the most effective way, please contact your local sales representative for assistance. If you are unaware of your local sales representative, please contact the Customer Support.

### Europe

KOLLMORGEN

Internet [www.kollmorgen.com/en-gb](http://www.kollmorgen.com/en-gb)

Archiv [www.wiki-kollmorgen.eu](http://www.wiki-kollmorgen.eu)

Support <https://kdn.kollmorgen.com/>

E-Mail [technik@kollmorgen.com](mailto:technik@kollmorgen.com)

Tel.: +49 (0)2102 - 9394 - 0

Fax: +49 (0)2102 - 9394 - 3155



KOLLMORGEN  
EU Website



European  
File Archive

### North America

KOLLMORGEN

Internet [www.kollmorgen.com/en-us](http://www.kollmorgen.com/en-us)

Support <https://kdn.kollmorgen.com/>

E-Mail [support@kollmorgen.com](mailto:support@kollmorgen.com)

Tel.: +1 - 540 - 633 - 3545

Fax: +1 - 540 - 639 - 4162



KOLLMORGEN  
US Website



KOLLMORGEN  
Developer Network

### South America

KOLLMORGEN

Internet [www.kollmorgen.com/pt-br](http://www.kollmorgen.com/pt-br)

Support <https://kdn.kollmorgen.com/>

E-Mail [contato@kollmorgen.com](mailto:contato@kollmorgen.com)

Tel.: +55 11 4615 - 6300



KOLLMORGEN  
Brazil Website

### Asia

KOLLMORGEN

Internet [www.kollmorgen.cn](http://www.kollmorgen.cn)

Support <https://kdn.kollmorgen.com/>

E-Mail [sales.china@kollmorgen.com](mailto:sales.china@kollmorgen.com)

Tel: +86 - 400 661 2802



KOLLMORGEN  
CN Website

**KOLLMORGEN**<sup>®</sup>

*Because Motion Matters™*