

EtherCAT®

Fieldbus Interface for S300 / S400 / S600 / S700



EtherCAT® 

Edition: August 2020

Translation of the original manual



For safe and proper use, follow these instructions.
Keep them for future reference.

Record of Document Revisions :

Revision	Remarks
10/2007	First edition
12/2009	S700 with EC onboard, symbols acc. to ANSI Z535.6B, branding, several minor corrections
12/2010	Company name
08/2011	Status word bits updated
05/2012	Free PDO mapping new, fixed PDO mapping extended
07/2014	Cyclical values corrected, status machine bits corrected, safe voltage changed to 60V, warning notes updated
04/2016	Table for controlword for a status change corrected, safe voltage changed to 50V, warning symbols updated, european directives updated
07/2016	Control word bit 15, Status word bit 14, Cyclic Setpoint 2308/2355 new, Cyclic Actual Value 2355/3612/2054/2055/2056 new, ASCII commands linked to the Product WIKI
11/2018	Layout of the warning notes updated, user expertise updated, new readers note on cover page
12/2019	Layout updated
08/2020	Setup Bit 16 corrected, layout updated

Trademarks

- Windows is a registered trademark of Microsoft Corporation.
- EtherCAT is registered trademark and patented technology, licensed by Beckhoff Automation GmbH, Germany.

Technical changes which improve the performance of the device may be made without prior notice!

This document is the intellectual property of Kollmorgen. All rights reserved. No part of this work may be reproduced in any form (by photocopying, microfilm or any other method) or stored, processed, copied or distributed by electronic means without the written permission of Kollmorgen.

1 Table of Contents

1 Table of Contents	3
2 General Informationen	5
2.1 About this manual	5
2.2 Target group	5
2.3 Using the PDF Format	5
2.4 Use as directed	6
2.5 Symbols Used	6
2.6 Abbreviations used	7
3 Installation / Setup	8
3.1 Assembly, Installation	8
3.1.1 Installing the expansion card (S300, S600)	9
3.1.1.1 Font view	9
3.1.1.2 LEDs	9
3.1.1.3 Connection technology	9
3.1.1.4 Connection diagram	9
3.2 Setup	10
3.2.1 Guide to setup	10
3.2.2 Setup Software for S300 and S700	10
3.2.3 EtherCAT Setup	11
4 EtherCAT	14
4.1 Slave Register	14
4.2 AL Event (Interrupt Event) and Interrupt Enable	15
4.2.1 Interrupt Enable Register (Address 0x0204:0x0205)	15
4.2.2 AL Event (Address 0x0220:0x0221)	15
4.3 Phase run-up	16
4.3.1 AL Control (Address 0x0120:0x0121)	16
4.3.2 AL Status (Address 0x0130:0x0131)	16
4.3.3 AL Status Code (Address 0x0134:0x0135)	16
4.3.4 EtherCAT communication phases	17
4.4 CANopen over EtherCAT (CoE) status machine	18
4.4.1 Status description	18
4.4.2 Commands in the control word	19
4.4.3 Status machine bits (status word)	20
4.5 Fixed PDO Mappings	21
4.6 Free PDO Mapping (S300/S700 only)	23
4.6.1 Example: Free PDO Mapping	24
4.7 Supported cyclical setpoint- and actual values	27
4.7.1 Supported cyclical setpoint values	27
4.7.2 Supported cyclical actual values	29
4.8 Supported operation modes	31
4.9 Adjusting the EtherCAT cycle time	31
4.10 Recommended cycle times depending on mode of operation	31
4.11 Synchronization based on cycle time	31
4.12 Latch controlword and Latch statusword	32
4.13 Mailbox Handling	33
4.13.1 Mailbox Output	34
4.13.2 Mail Input	35
4.13.3 Example: Mailbox access	36
5 Index	37

---/---

2 General Informationen

2.1 About this manual

This manual describes the installation, setup, range of functions and software protocol of the EtherCAT interface for SERVOSTAR 300 (S300), SERVOSTAR 400 (S400), SERVOSTAR 600 (S600) and S700 servo amplifiers and a reference for all commands which are used by these servo amplifiers.

SERVOSTAR 300-EC and SERVOSTAR 600-EC

The expansion card -EtherCAT- offers EtherCAT compatible connectivity to these servo amplifiers. The expansion card and the mounting is described in the servo amplifier's instructions manual. See chapter 3 for a short description (→ # 9).

SERVOSTAR 400-EC and S700

EtherCAT functionality is built-in on delivery in the SERVOSTAR 400-EtherCAT. The S700 servo amplifier has an EtherNet interface onboard, that has been configured to EtherCAT protocol.

This manual is part of the complete documentation of the digital servo amplifiers. The installation and setup of the servo amplifier, as well as all the standard functions, are described in the corresponding instructions manuals.

Other parts of the complete documentation

Title	Publisher
Instructions manual	Kollmorgen
Online-Help with ASCII Object Reference	Kollmorgen

2.2 Target group

This manual addresses personnel with the following qualifications:

- Transport:** Only by personnel with knowledge of handling electrostatically sensitive components.
- Unpacking:** Only by electrically qualified personnel.
- Installation:** Only by electrically qualified personnel.
- Setup :** Only by qualified personnel with extensive knowledge of electrical engineering and drive technology.
- Programming:** Software developers, EtherCAT project-planners

The qualified personnel must know and observe IEC 60364/ 60664, and regional accident prevention regulations.

Qualified Personnel only!

During operation there are deadly hazards, with the possibility of death, severe injury or material damage.

- The user must ensure that the safety instructions in this manual are followed.
- The user must ensure that all personnel responsible for working with the servo amplifier have read and understood the instructions manual.

Training courses are available on request.

2.3 Using the PDF Format

This document includes several features for ease of navigation

Cross References	Table of contents and index include active cross references.
Table of contents and index	Lines are active cross references. Click on the line and the appropriate page is accessed.
Page/chapter numbers in the text	Page/chapter numbers with cross references are active links.

2.4 Use as directed









Please observe the chapters "Use as directed" and "Prohibited use" in the instructions manual for the servo amplifier.

The EtherCAT interface serves only for the connection of the servo amplifier to a master with EtherCAT connectivity.

The servo amplifiers are components that are built into electrical apparatus or machinery, and can only be setup and operated as integral components of such apparatus or machinery.

We only guarantee the conformity of the servo amplifier with the directives listed in the EU Declaration of Conformity, if the components that we specify are used, and the installation regulations are followed.

2.5 Symbols Used

Symbol	Indication
 DANGER	Indicates a hazardous situation which, if not avoided, will result in death or serious injury.
 WARNING	Indicates a hazardous situation which, if not avoided, could result in death or serious injury.
 CAUTION	Indicates a hazardous situation which, if not avoided, could result in minor or moderate injury.
 NOTICE	Indicates situations which, if not avoided, could result in property damage.
 NOTE	This symbol indicates important notes.
	Warning of a danger (general). The type of danger is specified by the text next to the symbol.
	Warning of danger from electricity and its effects.
	Warning of danger from suspended loads.
	Warning of danger from automatic start.

2.6 Abbreviations used

Abbreviation	Meaning
AL	Application Layer: the protocol that directly used by the process entities.
Cat	Category – classification for cables that is also used in Ethernet. Cat 5 is the minimum required category for EtherCAT.
DC	Distributed Clocks Mechanism to synchronize EtherCAT slaves and master
DL	Data Link, also known as Layer 2. EtherCAT uses Ethernet, which is standardized as IEEE 802.3.
ECAT	EtherCAT: RT Standard for Industrial Ethernet Control Automation Technology
FPGA	Field Programmable Gate Array
FTP	File Transfer Protocol
HW	Hardware
ICMP	Internet Control Message Protocol: Mechanisms for signaling IP errors.
IEC	International Electrotechnical Commission: The international standards
IEEE	Institute of Electrical and Electronics Engineers, Inc.
ISO/OSI Model	ISO Open Systems Interconnection Basic Reference Model (ISO 7498): describes the division of communication into 7 layers.
LLDP	Lower Layer Discovery Protocol
MAC	Media Access Control
MII	Media Independent Interface: Standardized interface between the Ethernet controller and the routing equipment.
MDI	Media Dependant Interface: Use of connector Pins and Signaling.
MDI-X	Media Dependant Interface (crossed): Use of connector Pins and Signaling with crossed lines.
OSI	Open System Interconnect
OUI	Organizational Unique Identifier – are the first 3 Bytes of an Ethernet-Address, that will be assign to companies or organizations and can be used for protocol identifiers as well (e.g. LLDP)
PDI	Physical Device Interface: a set of physical elements that allows access to ESC from the process side.
PDO	Process Data Object
PDU	Protocol Data Unit: Contains protocol information transferred from a protocol instance of transparent data to a subordinate level
Ping	Frame that verifies whether the partner device is still available.
PHY	Physical interface that converts data from the Ethernet controller to electric or optical signals.
PLL	Phase Locked Loop
PTP	Precision Time Protocol in accordance with IEEE 1588
RSTP	Rapid Spanning Tree Protocol
RT	Real-time, can be run in Ethernet controllers without special support.
RT Frames	EtherCAT Messages with EtherType 0x88A4.
RX	Receive
RXPDO	Receive PDO
SNMP	Simple Network Management Protocol
SPI	Serial Peripheral Interface
Src Addr	Source Address: Source address of a message.
STP	Shielded Twisted Pair
TCP	Transmission Control Protocol
TX	Transmit
TXPDO	Transmit PDO
UDP	User Datagram Protocol: Non-secure multicast/broadcast frame.
UTP	Unshielded Twisted Pair
XML	Extensible Markup Language
XML Parser	Program for checking XML schemas.
ZA ECAT	Access mode EtherCAT
ZA Drive	Access mode Drive

3 Installation / Setup

3.1 Assembly, Installation



DANGER High Voltages up to 900V!

Risk of electric shock. Residual charges in the capacitors can still have dangerous levels several minutes after switching off the supply voltage. Power and control connections can still be live, even though the motor is not rotating.

- Install and wire up the equipment only while it is not electrically connected.
- Make sure that the control cabinet is safely isolated (lock-out, warning signs etc.). The individual supply voltages will not be switched on until setup is carried out.
- Measure the voltage in the intermediate (DC-link) circuit and wait until it has fallen below 50V.



WARNING Automatic Start!

Risk of death or serious injury for humans working in the machine. Drives with servo amplifiers in fieldbus systems are remote-controlled machines. They can start to move at any time without previous warning.

- Implement appropriate protective measures to ensure that any unintended start-up of the machines cannot result in dangerous situations for personnel or machinery.
- The user is responsible for ensuring that, in the event of a failure of the servo amplifier, the drive is set to a state that is functional safe, for instance with the aid of a safe mechanical brake.
- Software limit-switches are not a substitute for the hardware limit-switches in the machine.

NOTICE

Install the servo amplifier as described in the instructions manual. The wiring for the analog set-point input and the positioning interface is not required.

NOTE

Because of the internal representation of the position-control parameters, the position controller can only be operated if the final limit speed of the drive does not exceed:

rotatory

at sinusoidal² commutation: 7500 rpm

at trapezoidal commutation: 12000 rpm.

linear

at sinusoidal² commutation: 4 m/s

at trapezoidal commutation: 6.25 m/s

NOTE

All the data on resolution, step size, positioning accuracy etc. refer to calculatory values. Non-linearities in the mechanism (backlash, flexing, etc.) are not taken into account.

If the final limit speed of the motor has to be altered, then all the parameters that were previously entered for position control and motion blocks must be adapted.

3.1.1 Installing the expansion card (S300, S600)

Fit the EtherCAT expansion card into a the servo amplifier:

NOTE

1. Use a suitable screwdriver to lever off the cover of the option slot (see instructions manual).
2. Take care that no small items (such as screws) fall into the open option slot.
3. Push the expansion card carefully into the guide rails that are provided, without twisting it.
4. Press the expansion card firmly into the slot, until the front cover touches the fixing lugs. This ensures that the connectors make good contact.
5. Screw the screws on the front cover into the threads in the fixing lugs.

3.1.1.1 Front view

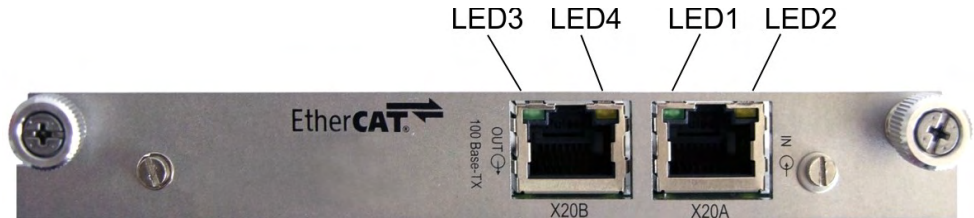

3.1.1.2 LEDs

LED	Function
ERROR	flickering = Booting Error blinking = Invalid Configuration single flash = Unsolicited State Change double flash = Watchdog Timeout off = No Error
RUN	on = Device is in state OPERATIONAL blinking = Device is in state PRE-OPERATIONAL single flash = Device is in state SAFE-OPERATIONAL off = Device is in state INIT
ACT IN	on = linked, but not active at X20A (in) flickering = linked and active at X20A (in) off = not linked at X20A (in)
ACT OUT	on = linked, but not active at X20B (out) flickering = linked and active at X20B (out) off = not linked at X20B (out)

3.1.1.3 Connection technology

Connection to the EtherCAT Network via RJ-45 connectors X20 A (in port) and X20 B (out port).

3.1.1.4 Connection diagram

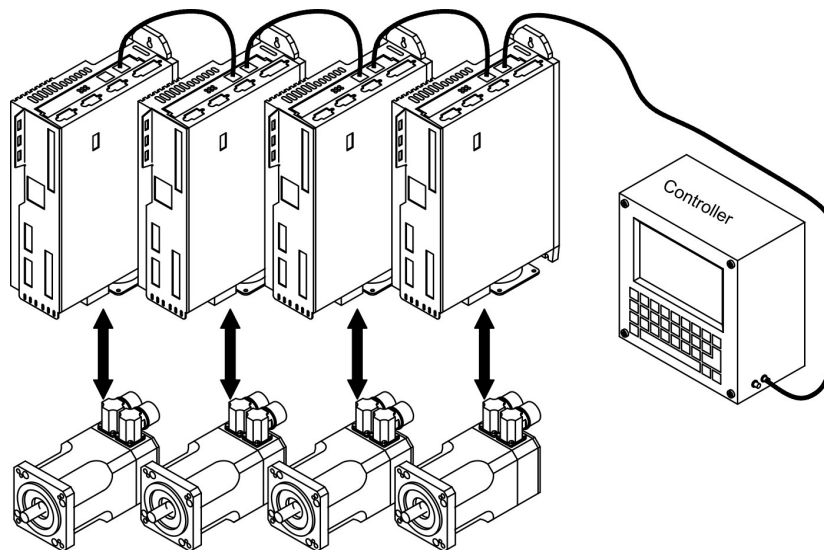

3.2 Setup

3.2.1 Guide to setup

NOTICE

Only professional personnel with extensive knowledge of control and amplifier technology are allowed to setup the servo amplifier.



WARNING Automatic Restart!

Risk of death or serious injury for humans working in the machine. The drive performing unplanned movements during commissioning cannot be ruled out. Make sure that, even if the drive starts to move unintentionally, no danger can result for personnel or machinery. The measures you must take in this regard for your task are based on the risk assessment of the application.

Check assembly / installation	Check that all the safety instructions in the instructions manual for the servo amplifier and this manual have been observed and implemented. Check the setting for the station address and baud rate.
Connect PC, start setup software	Use the setup software to set the parameters for the servo amplifier.
Setup basic functions	Start up the basic functions of the servo amplifier and optimize the current, speed and position controllers. This section of the setup is described in the in the online help of the setup software.
Save parameters	When the parameters have been optimized, save them in the servo amplifier.

3.2.2 Setup Software for S300 and S700

EtherCAT Communication State

AL - Control Word

AL - Status Word

EtherCAT cyclic Mapping

Command Mapping

Actual Mapping

CAN over EtherCAT State Machine

Control Word

Status Word

Specific Settings

Execute COLDSTART in AL-Boot State

Do not check Synchronization

Do not check missing interrupts

Do not permit CLRFAULT on hard faults

EtherCAT Cycle Time
 x 250 μ s

3.2.3 EtherCAT Setup

Prerequisites for this startup example:

- Correctly configured EtherCAT card in the master.
- TwinCAT software from Beckhoff (NC-Mode setup).
- XML description of the servo amplifier (the XML file on the CD-ROM or on the Kollmorgen website).

Bit 16 (0x10000) in the DRVCNFG3 parameter influences how the servo amplifier books into the EtherCAT bus. If bit 16 is set, the file Kollmorgen_S300_S700.xml will be used; if bit 16 is not set, the ESI file Danaher_S300_S400_S600_S700.xml will be used by the master.

Copy the XML description of the servo amplifier into the TwinCAT system (usually to the folder named C:\TwinCAT\IO\EtherCAT) and restart the TwinCAT system. TwinCAT will now offer you a choice of Kollmorgen servo amplifiers that support EtherCAT.

Continue as follows:

1. Click with right mouse button to I/O-Devices, add a new box and select the servo amplifier

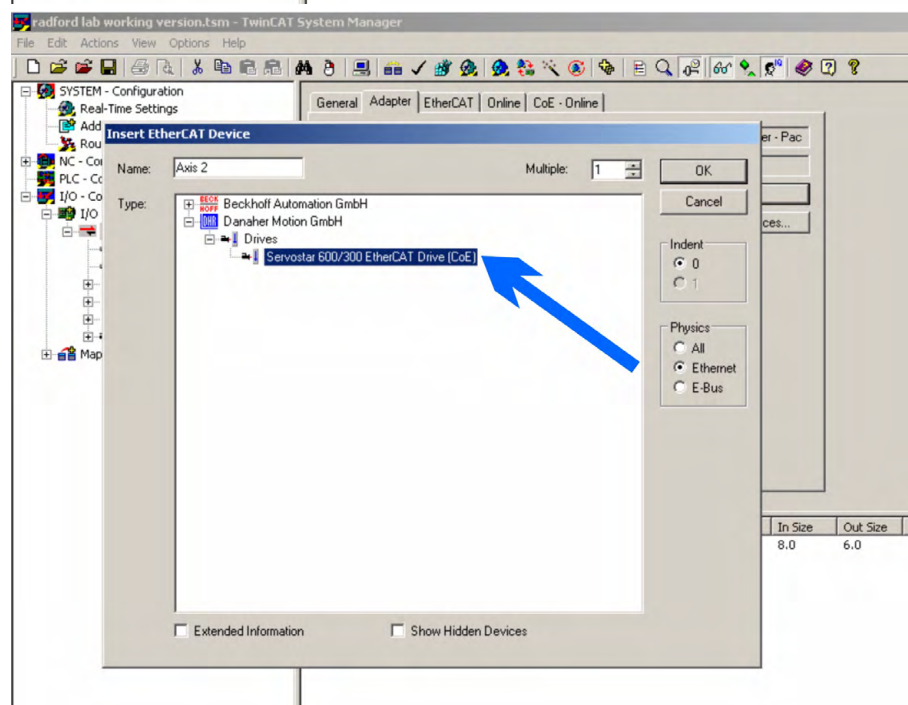
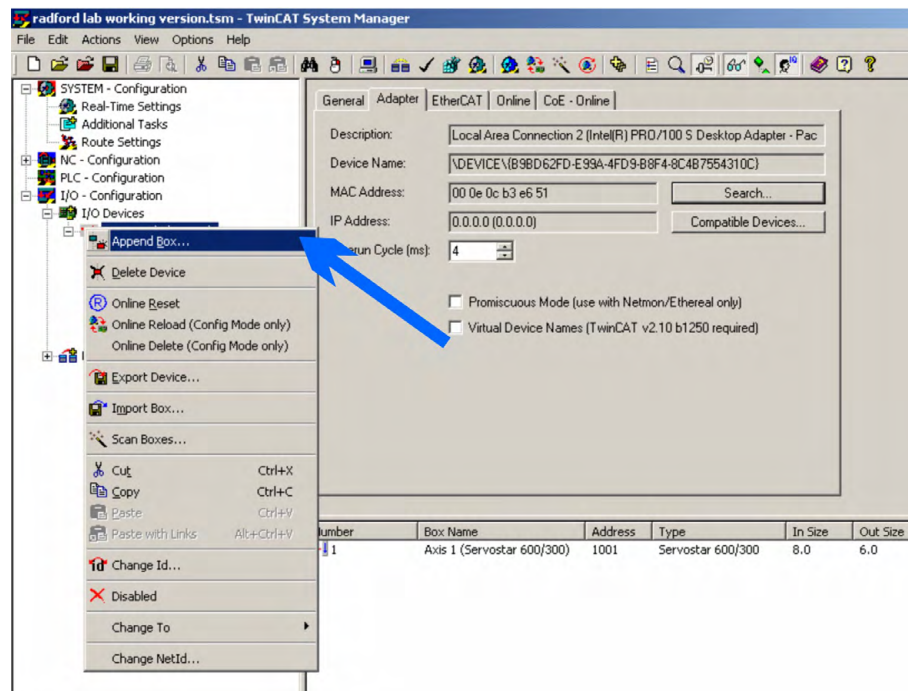

2. Setup an NC task

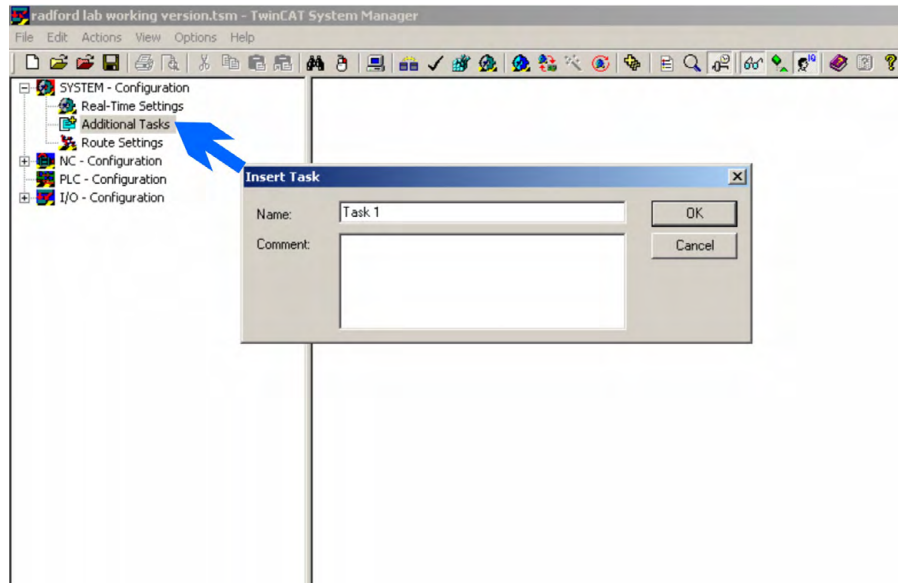

3. Setup a drive in the NC task

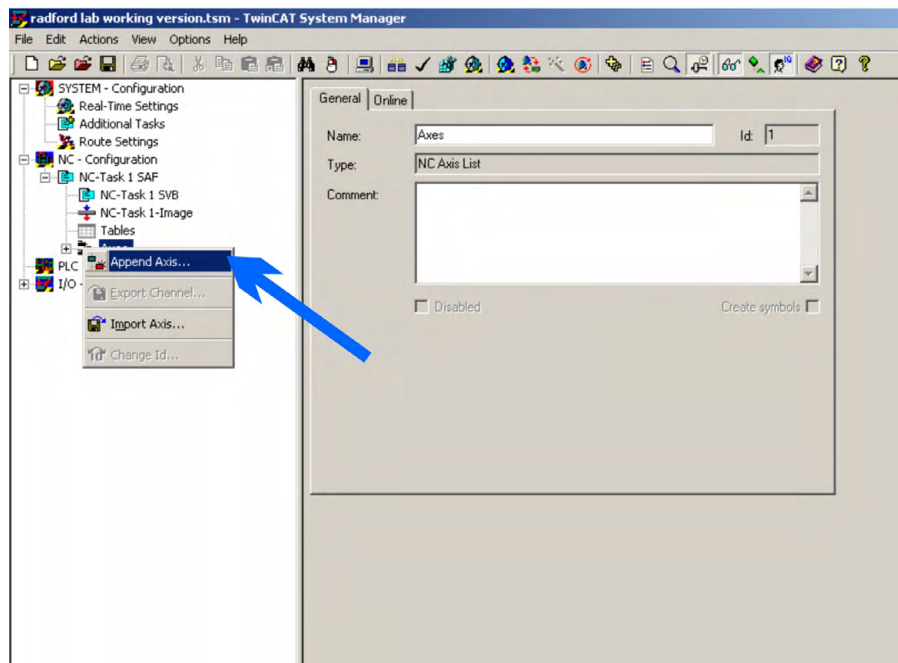

4. Select the axis type and choose the axis

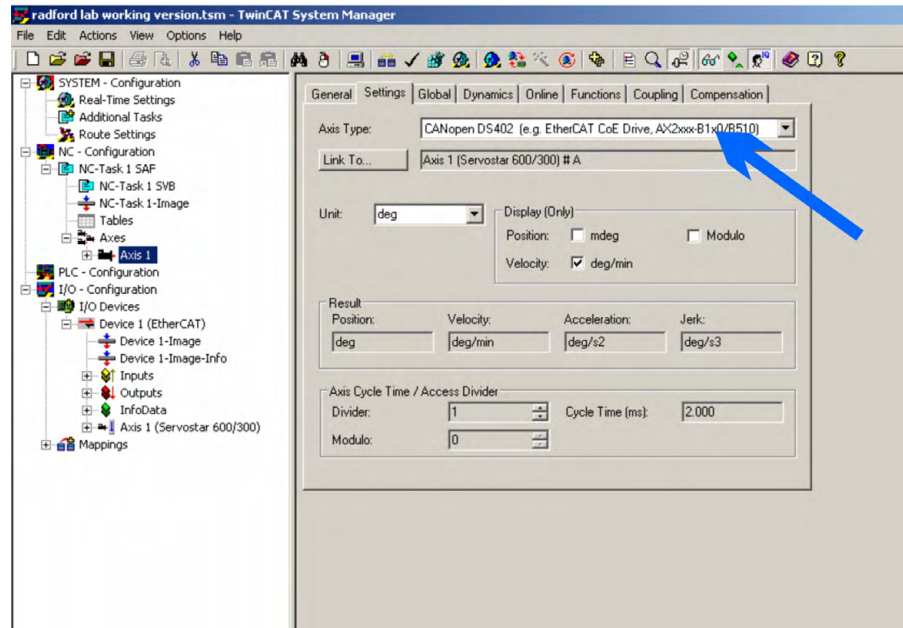

5. Create, check, activate and start the configuration

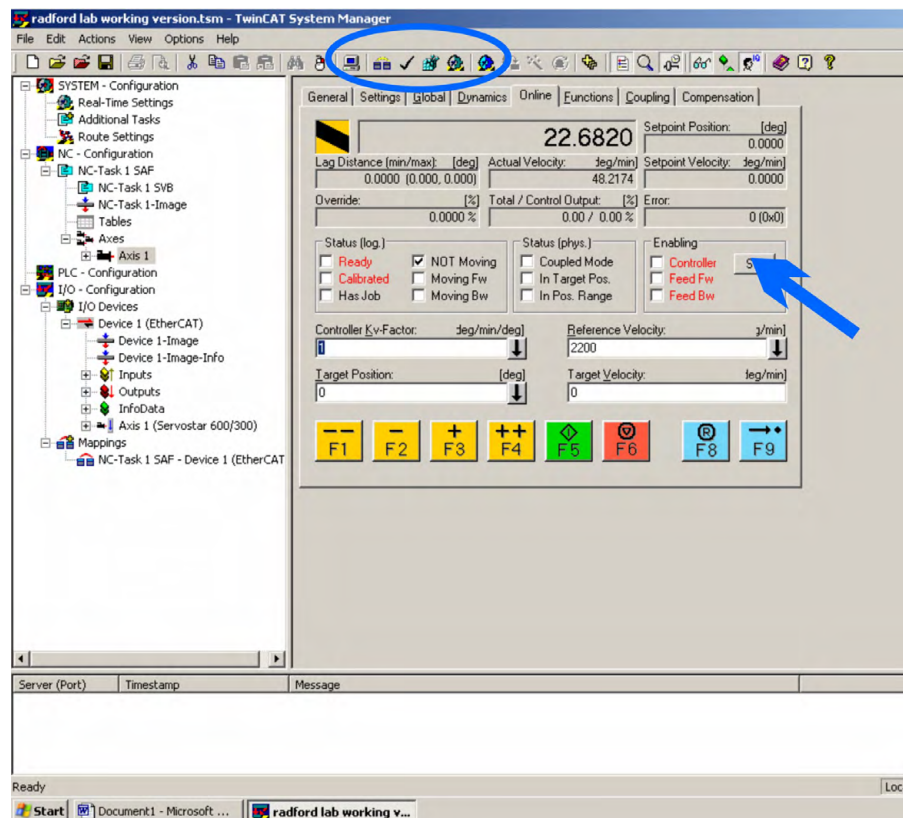

Enable the axis:

Click "Set" button (see arrow, servo amplifier power and enable signal must be present, motor and feedback must be configured).

Move the axis:

Click buttons "F1"... "F4"

4 EtherCAT

4.1 Slave Register

The table below gives the addresses of individual registers in the FPGA memory. The data is provided in little-endian format, with the 'least significant byte' occupying the lowest address. A detailed description of all registers and FPGA memory locations is available in the "EtherCAT Slave Controller" description of the EtherCAT user organization (www.ethercat.org).

Address	Length (Byte)	Description	Z ECAT*	ZA Drive*
0x0120	2	AL Control	r/w	r/-
0x0130	2	AL Status	r/-	r/w
0x0134	2	AL Status Code	r/-	r/w
0x0204	2	Interrupt Enable Register	r/-	r/w
0x0220	2	AL Event (IRQ Event)	r/w	r/-
0x0800	8	Sync Manager 0 (Mail Out Control Register)	r/w	r/-
0x0808	8	Sync Manager 1 (Mail In Control Register)	r/w	r/-
0x0810	8	Sync Manager 2 (Process data Output Control Register)	r/w	r/-
0x0818	8	Sync Manager 3 (Process data Input Control Register)	r/w	r/-
0x0820	8	Sync Manager 4	r/w	r/-
0x0828	8	Sync Manager 5	r/w	r/-
0x0830	8	Sync Manager 6	r/w	r/-
0x0838	8	Sync Manager 7	r/w	r/-
0x0840	8	Sync Manager 8	r/w	r/-
0x1100	64	ProOut Buffer (Process data Output, setpoints ECAT)	r/w	r/-
0x1140	72	ProIn (Process data Input, act. values ECAT)	r/-	r/w
0x1800	512	Mail Out Buffer (Object Channel Buffer ECAT)	r/w	r/-
0x1C00	512	Mail In Buffer (Object Channel Buffer Drive)	r/-	r/w

* ZA ECAT = Acces mode EtherCAT, ZA Drive = Access mode Drive

4.2 AL Event (Interrupt Event) and Interrupt Enable

Communication between the drive and the EtherCAT FPGA is completely interrupt-driven. The interrupt enable register and the AL event register are responsible for the EtherCAT interface interrupt functionality.

The servo amplifier activates individual EtherCAT interface events when the corresponding bit of the interrupt enable register is set to 1. When it is set to 0, the events are deactivated.

4.2.1 Interrupt Enable Register (Address 0x0204:0x0205)

Parameter	Address	Bit	ZA Drive	ZA ECAT	Description
AL Control Event	0x204	0	r/w	r	Activation of AL control event for phase run-up
-	0x204	1	r/w	r	Reserved
DC Distributed Clock	0x204	2	r/w	r	Activation of distributed clock (DC) interrupts for entire communication
-	0x204	3...7	r/w	r	Reserved
Mail Out Event	0x205	0	r/w	r	Activation of output event mailbox (SDO, Sync Manager 0) for object channel.
Mail In Event	0x205	1	r/w	r	Activation of input event mailbox (SDO, Sync Manager 1) for object channel.
Pro Out Event	0x205	2	r/w	r	Activation of output event process data (PDO, card's cyclical setpoints)
Pro In Event	0x205	3	r/w	r	Activation of input event process data (PDO, servo amplifier's cyclical actual values)
-	0x205	4...7	r/w	r	Reserved

When the relevant bit of the AL event register is set to 1, the EtherCAT interface tells the servo amplifier which event it should process in the interrupt routine.

4.2.2 AL Event (Address 0x0220:0x0221)

Parameter	Address	Bit	ZA Drive	ZA ECAT	Description
AL Control Event	0x220	0	r	r/w	Processing of AL control event for phase run-up
Sync Manager Watchdog Event	0x220	1	r	r/w	Processing of a Sync Manager watchdog event
Distributed Clock (DC) Event	0x220	2	r	r/w	Processing of a distributed clock (DC) event
-	0x220	3...7	r	r/w	Reserved
Sync Manager 0 Event	0x221	0	r	r/w	Activation of output event mailbox (SDO, Sync Manager 0) for object channel.
Sync Manager 1 Event	0x221	1	r	r/w	Activation of input event mailbox (SDO, Sync Manager 1) for object channel.
Sync Manager 2 Event	0x201	2	r	r/w	Activation of output event process data (PDO, card's cyclical setpoints)
Sync Manager 3 Event	0x201	3	r	r/w	Activation of input event process data (PDO, servo amplifier's cyclical actual values)
Sync Manager 4 – 7 Event	0x221	4...7	r	r/w	Reserved
Sync Manager 8 – 15 Event	0x222	0...7	r	r/w	Reserved

4.3 Phase run-up

The AL control, AL status and AL status code registers are responsible for communication phase run-up (also referred to as EtherCAT status change), for current status display and for any fault messages. The servo amplifier responds to every EtherCAT interface transition request made by the AL control register and to every AL control event (interrupts) by means of the AL status register. Any fault messages are displayed in the AL status code register.

4.3.1 AL Control (Address 0x0120:0x0121)

Parameter	Address	Bit	ZA Drive	ZA ECAT	Description
Status	0x120	3...0	r	w	0x01: Init Request 0x02: PreOperational Request 0x03: Bootstrap Mode Request 0x04: Safe Operational Request 0x08: Operational Request
Acknowledgement	0x120	4	r	w	0x00: No fault acknowledgement 0x01: Fault acknowledgement on positive edge
Reserved	0x120	7...5	r	w	-
Applic. specific	0x120	15...8	r	w	-

4.3.2 AL Status (Address 0x0130:0x0131)

Parameter	Address	Bit	ZA Drive	ZA ECAT	Description
Status	0x130	3...0	w	r	0x01: Init 0x02: PreOperational 0x03: Bootstrap Mode 0x04: Safe Operational 0x08: Operational
Status change	0x130	4	w	r	0x00: Acknowledgement 0x01: Error, e.g. forbidden transition.
Reserved	0x130	7...5	w	r	-
Applic. specific	0x130	15...8	w	r	-

4.3.3 AL Status Code (Address 0x0134:0x0135)

Parameter	Address	Bit	ZA Drive	ZA ECAT	Description
Status	0x134	7...0	w	r	See table below
Status	0x135	7...0	w	r	See table below

Code	Description	Current Status (Status change)	Resulting Status
0x0000	No error	All	Current Status
0x0011	Invalid requested state change	I -> S, I -> O, P -> O, O -> B, S -> B, P -> B	Current Status + E
0x0017	Invalid sync manager configuration	P -> S, S -> O	Current Status + E
0x001A	Synchronize error	O, S -> O	S + E

No other codes are supported.

4.3.4 EtherCAT communication phases

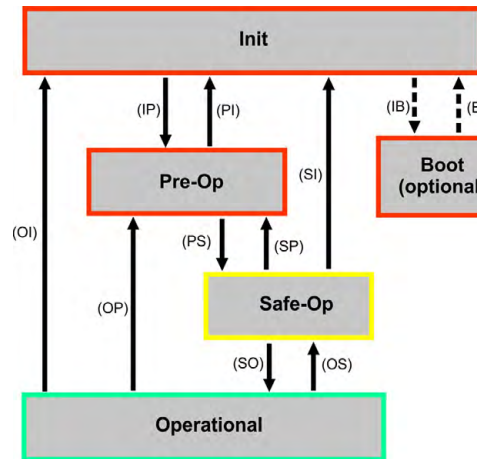

INIT:

Initialization, no communication.

PRE-OP:

Mailbox active, slave parameterization and startup parameters.

SAVE-OP:

Cyclical actual values are transferred and the servo amplifier tries to synchronize.

OPERATIONAL:

Cyclical setpoints are processed, torque enable can be activated and the servo amplifier must be synchronized.

Description of the individual communication transitions

Transition	AL Control (Bit 3...0)	Description
(IB)	0x03	Hardware reset request by controller
(BI)	-	Servo amplifier hardware reset
(IP)	0x02	Activation of mailbox (SyncManager 0 and 1) and activation of servo amplifier synchronization routine. As the EC interface is not yet generating cyclical interrupts, warning n17 appears on the amplifier (no sync).
(PI)	0x01	Deactivation of all EtherCAT events apart from AL control and stopping of mailbox activities
(PS)	0x04	The amplifier checks the communication configuration provided by the master in pre-op status. Non-fatal faults are automatically cleared (no COLDSTART). Mapping of various setpoints and actual values (PDO mapping). Mapping can be set in advance via the mailbox. The EtherCAT interface produces cyclical interrupts, thereby enabling it to obtain cyclical actual values. The amplifier begins to synchronize with the ECAT interface's cyclical IRQs. The Pro_In and Pro_Out events are activated; these are responsible for the amplifier's cyclical setpoints (Pro_Out) and actual values (Pro_In).
(SP)	0x02	The ECAT interface stops producing cyclical interrupts. As a result, the loss of synchronization warning appears on the amplifier (n17) and the actual values are no longer updated.
(SI)	0x01	Deactivation of all EtherCAT events apart from AL control. In addition, the ECAT interface stops sending interrupts, causing the amplifier to lose synchronization (warning n17) and cease updating actual values. All mailbox activities are also stopped.
(SO)	0x08	The amplifier only completes this transition after successful synchronization, the synchronization warning (n17) is canceled. Failing this, synchronization fault (F28) is set after a time-out period has elapsed. This transition enables processing of the control word, making it possible to transfer and process the cyclical PDO setpoints.
(OS)	0x04	Blocking of setpoint transfer
(OP)	0x02	The ECAT interface stops producing cyclical interrupts. As a result, the loss of synchronization warning appears on the amplifier (n17) and the actual values are no longer updated.
(OI)	0x01	Deactivation of all EtherCAT events apart from AL control. In addition, the ECAT interface stops sending interrupts, causing the amplifier to lose synchronization (warning n17) and cease updating actual values. Stopping of all mailbox activities.

4.4 CANopen over EtherCAT (CoE) status machine

The status machine for the control and status words corresponds to the CANopen status machine in accordance with DS402. Control and status words are captured in every instance of fixed PDO mapping (see chapter entitled 'Fixed PDO Mapping' (→ # 21)).

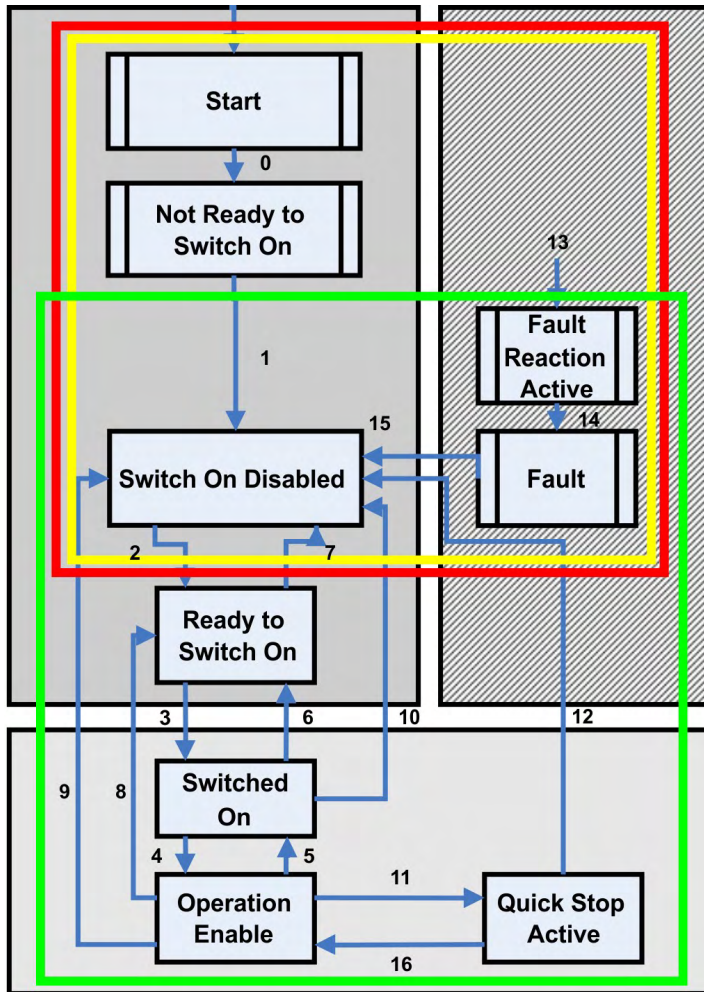

The status word is only updated and written by the amplifier in **Safe-Op** and **Operational** stati.

The control word is only read in during **Operational** status.

4.4.1 Status description

Status	Description
Not Ready to Switch On	The servo amplifier is not ready to switch on; the controller has not indicated readiness for service. The servo amplifier is still in the boot phase or in fault status.
Switch On Disable	In 'Switch On Disable' status, the amplifier cannot be enabled via the EtherCAT interface, because (for example) there is no connection to a power source.
Ready to Switch On	In 'Ready to Switch On' status, the servo amplifier can be enabled via the control word.
Switched On	In 'Switched On' status, the amplifier is enabled, but the setpoints of the EtherCAT-interface are not yet transferred. The amplifier is idle, and a positive edge in bit 3 of the control word activates setpoint transfer (transition to 'Operation Enable' status).
Operation Enable	In this status, the servo amplifier is enabled and setpoints are transferred from the EtherCAT interface.
Quick Stop Active	The servo amplifier follows a quick stop ramp.
Fault Reaction Active	The servo amplifier responds to a fault with an emergency stop ramp.
Fault	A fault is pending, the drive is stopped and disabled.

4.4.2 Commands in the control word

The servo amplifier evaluates the bits of the control word. Commands for a status change:

Transition	Bit 7 Quit fault	Bit 3 Common set- point enable	Bit 2 Enable for Bit 3 and show Bit 5 in the Statusword	Bit 1 Enable Switch On	Bit 0 Enable if Bit1=1
0	-	-	-	-	-
1	-	-	-	0	-
2	-	-	-	1	0
3	-	-	1	1	P
4	-	P	1	1	1
5	-	N	1	1	1
6	-	-	-	1	N
7	-	-	-	N	-
8	-	-	-	1	N
9	-	-	-	N	-
10	-	-	-	N	-
11	-	1	N	1	1
12	-	-	-	N	-
13	-	1	1	1	1
14	-	1	1	1	1
15	P	-	-	-	-
16	-	1	P	1	1

Bits labeled "-" are irrelevant. 0 and 1 indicate the status of individual bits.

P indicates a positive edge in the bit; N indicates a negative edge.

Actions on positive edges in control word bits:

Bit	Action
0	Enabling of the servo amplifier when the switch-on inhibit is canceled (Bit1=1)
1	Cancellation of switch-on inhibit
2	Activation of bit 5 display in the status word if Bit0 & Bit1 = 1. Enable for bit 3 in the control word
3	Setpoint enabling if Bit0, Bit1 and Bit2 = 1
7	Sending of clear fault command (CLRFAULT). If bit 19 of the ASCII SERCSET parameter is set and a fault necessitating a hardware reset is pending, the servo amplifier generates an F29.
11	Start of a reference run if the drive is in referencing mode (OPMODE 8)
12	Sending of a SAVE command.
15	Toggle bit for ASCII communication via flexible PDO. Every change of this bit causes a transfer of ASCII data bytes from the mapped PDO 0x2355 to the internal ASCII command processing.

Actions on negative edges in control word bits:

Bit	Action
0	Disabling of the drive (sending of the DIS ASCII command)
1	If Bit 1 is not showing a negative edge, braking with the DECSTOP ramp and disabling.
2	If neither bit 1 nor bit 2 are showing a negative edge, braking with the DECDIS ramp and continuation of the enabled state.
3	Deactivation of setpoint transfer from EtherCAT interface and stopping of drive in speed control mode (OPMODE 0)
7	Resetting of clear fault (CLRFAULT) command channel
11	Resetting of reference run command channel
12	Resetting of SAVE command channel
15	Toggle bit for ASCII communication via flexible PDO. Every change of this bit causes a transfer of data bytes from the mapped PDO 0x2355 to the internal command processing.

4.4.3 Status machine bits (status word)

Status	Bit 6 = Switch on Disabled	Bit 5 = no emer- gency stop active	Bit 3 = Error	Bit 2 = Operation Enable	Bit 1 = Switched on	Bit 0 = Ready to switch on
Not Ready to Switch On	1	-	0	0	0	0
Switch On Disabled	1	-	0	0	0	0
Ready to Switch On	0	-	0	0	0	1
Switch On	0	1	0	0	1	1
Operation Enable	0	1	0	1	1	1
Fault	0	1	1	0	0	0
Fault reaction active	0	0	1	1	1	1
Quick Stop Active	0	0	0	0	1	1

Bits labeled "-" are irrelevant. 0 and 1 indicate the status of individual bits.

Remaining status word bits:

Bit 7: 1 = Warning present

Bit 8: 1 = Following error present (in all positioning modes ([OPMODE](#) = 4, 5, 6, 8))

Bit 9: 1 = Reference point set

Bit 10: 1 = Target reached (in Position)

Bit 11: 1 = Hardware limit switch or Software limit switch reached

Bit 12: 1 = EtherCAT communication OK

Bit 13: 1 = Homing error / emergency stop activated

Bit 14: 1 = Actual servo amplifier error Fxx can only be cleared by a hardware reset

CAUTION: EtherCAT communication lost!

Bit 15: 1 = Motion task active (in profile position mode)

4.5 Fixed PDO Mappings

Various ready-to-use mappings can be selected for cyclical data exchange via objects 0x1C12 and 0x1C13. Using object 1C12 subindex 1 (Sync Manager 2 PDO assignment), a fixed mapping for the cyclical setpoint can be set with values 0x1701 to 0x1714. Using object 1C13 subindex 1 (Sync Manager 3 PDO assignment), a fixed mapping for the cyclical drive actual values can be set with values 0x1B01 to 0x1B0C.

The sequence describes how to select the fixed command value mapping 0x1701 via SDO's:

1. SDO write access to object 0x1C12Sub0 Data:0x00
2. SDO write access to object 0x1C12Sub1 Data:0x1701
3. SDO write access to object 0x1C12Sub0 Data:0x01

1. Position interface

0x1701: Position setpoint (4 Byte), Controlword(2 Byte), total (6 Byte); default for S400/S600

0x1B01: Position act.value (4 Byte), Statusword (2 Byte), total (6 Byte)

2. Velocity interface

0x1702: Velocity setpoint (4 Byte), Controlword (2 Byte), total (6 Byte); default for S300/S700

0x1B01: Position act.value (4 Byte), Statusword (2 Byte), total (6 Byte)

3. Torque interface

0x1703: Current setpoint (2 Byte), Controlword (2 Byte), total (4 Byte)

0x1B03: Position act.value (4 Byte), Current act.value (2 Byte), Statusword (2 Byte), total (8 Byte)

4. Position-, velocity- and Torque-interface with operation mode switch

0x1704: Position setpoint (4 Byte), Velocity setpoint (4 Byte), Current setpoint (2 Byte), OPMODE request (2 Byte), Controlword (2 Byte), total (14 Byte)

0x1B04: Position act.value (4 Byte), Current act.value (2 Byte), OPMODE status (2 Byte), Statusword (2 Byte), total (10 Byte)

5. Position- and Velocity-interface with extension „Torque“

0x1705: Position setpoint (4 Byte), Velocity setpoint (4 Byte), Additive Current setpoint (2 Byte), Current limit (2 Byte), Controlword (2 Byte), total (14 Byte)

0x1B05: Position act.value (4 Byte), Current act.value (2 Byte), Drive-following-error (4 Byte), Statusword (2 Byte), total (12 Byte)

6. Position- and Velocity-interface with extension „Latch“

0x1706: Position setpoint (4 Byte), Velocity setpoint (4 Byte), Controlword (2 Byte), Latchcontrolword (2 Byte), total (12 Byte)

0x1B06: Position act.value (4 Byte), Statusword (2 Byte), Latchstatusword (2 Byte), Latchposition (4 Byte), total (12 Byte)

7. Positioninterface 1 + 2, Velocity- and Torque-interface and extension „Latch“

0x1707: Position setpoint (4 Byte), Velocity setpoint (4 Byte), Current setpoint (2Byte), Current limit (2 Byte), Controlword (2 Byte), Latchcontrolword (2 Byte), total (16 Byte)

0x1B07: Position act.value (4 Byte), Position act.value 2 (4 Byte), Current act.value (2 Byte), Drive-following-error (4 Byte), Statusword (2 Byte), Latchstatusword (2 Byte), Latchposition (4 Byte), total (22Byte)

8. Position-, Velocity- and Torque-interface with macro variable-Switch and extension „Torque“+„Latch“

0x1708: Position setpoint (4 Byte), Velocity setpoint (4 Byte), Current setpoint (2 Byte), Current limit (2 Byte), OPMODE request (2 Byte), Controlword (2 Byte), Latch-controlwort (2 Byte), total (18 Byte)

0x1B08: Position act.value (4 Byte), Current act.value (2 Byte), Drive-following-error (4 Byte), Opmode message (2 Byte), Statusword (2 Byte), Latchstatusword (2 Byte), Latchposition (4 Byte), total (20 Byte)

9. S300/S700 only: Position interface with extension for setting / reading of digital I/O

0x170A: Position setpoint (4 Byte), Controlword (2 Byte), set value for digital output1/bit 0 and output2/bit 1 (2 Byte), total (10 Byte)

0x1B0A: Position act.value(4 Byte), OPMODE message (2 Byte), Statusword (2 Byte), digital input state (2 Byte), total (8 Byte)

10. S300/S700 only:Motion tasks interface + digital/analog I/O + actual drive values

0x1710: target position [O_P](#) (4 Byte), target velocity [O_V](#) (4 Byte), motion task control word [O_C](#) (4 Byte), MT acceleration [O_ACC](#) (4 Byte), MT deceleration [O_DEC](#) (4 Byte), MT profile [O_TAB](#) (2 Byte), Controlword (2 Byte), Latch control word (2 Byte), total (26 Bytes)

0x1B0B: Position act.value (4 Byte), Position actual value 2 (4 Byte), Velocity actual value (4 Byte), Current actual value (2 Byte), Statusword (2 Byte), Drive error status (4 Byte), Drive warnings (4 Byte), digital input state (4 Byte), analog input 1 (2 Byte), analog input 2 (2 Byte), following error (4 Byte), Motion task status [TRJSTAT](#) (4 Byte), Total (40 Byte)

11. S300/S700 only:Position interface with latch extension

0x1711: Position set point (4 Byte), Velocity feed forward (4 Byte), current feed forward (2 Byte), current limit (2 Byte), control word (2 Byte), latch control word (2 Byte), total (16 Byte)

e.g. 0x1B06

12. S300/S700 only:Velocity interface with latch extension

0x1712: velocity set point (4 Byte), velocity feed forward (4 Byte), current feed forward (2 Byte), current limit (2 Byte), control word (2 Byte), latch control word (2 Byte), total (16 Byte)

e.g. 0x1B06

13. S300/S700 only:Macro program interface

0x1714: control word (2 Byte), user variable [DPRVAR2](#) (2 Byte), user variable [DPRVAR3](#) (4 Byte), user variable [DPRVAR4](#) (4 Byte), user variable [DPRVAR5](#) (4 Byte), user variable [DPRVAR6](#) (4 Byte), total (20 Byte)

0x1B0C: Position act. Value (4 Byte), velocity actual value (4 Byte), status word (2 Byte), user variable [DPRVAR9](#) (2 Byte), user variable [DPRVAR10](#) (4 Byte), user variable [DPRVAR11](#) (4 Byte), user variable [DPRVAR12](#) (2 Byte), user variable [DPRVAR13](#) (2 Byte), user variable [DPRVAR14](#) (4 Byte), total (28 Byte)

NOTE

Fixed mappings with more than 22 bytes can only be used with S300/S700 only in combination with extended mapping memory (XML version 2, [DRVCNFG3](#) = 0x10000).

4.6 Free PDO Mapping (S300/S700 only)

In addition to the fixed PDO mapping the free mapping of real-time objects is possible. This mapping is only available when the parameter [DRVCNFG3](#) bit 16 (0x10000) is set to 1. The configuration is similar to the described sequence for the fixed mappings:

1. The mapping selection is cleared (write 0 to object 0x1C12 sub 0 and 1C13 sub 0)
2. The free mapping is built with the objects 0x1600 sub 1 .. n (receive-direction) and/or 0x1a00 sub 1 ... m (transmit direction) in the CANopen manner.
3. SDO write access to the objects 0x1C12 sub 0 and/or 0x1C13 sub 0 with the number 1.

Example see (→ # 24).

The cyclically used data are visible in the PDO assignment window for the Inputs and Outputs of the Sync Managers. Default setting are the fixed PDOs 0x1701 and 0x1B01 (visible contents when selected in the PDO list)..

The screenshot shows the configuration interface for EtherCAT. On the left is a tree view of the system configuration. The main window is titled 'EtherCAT' and contains several panels:

- Sync Manager:** A table with columns SM, Size, Type, and Fla... containing entries for SM 0, 1, 2, and 3.
- PDO List:** A table listing PDOs with columns Index, Size, Name, Flags, SM, and SU. It includes entries for 0x1A00 through 0x1B0C and 0x1600.
- PDO Assignment (0x1C12):** A list of checkboxes for PDOs 0x1600 through 0x1707. 0x1600 is checked.
- PDO Content (0x1A00):** A table with columns Index, Size, Offs, Name, Type, and Default. It shows a 'Status word' at index 0x6041...
- Download:** A section with checkboxes for 'PDO Assignment' (checked) and 'PDO Configuration' (unchecked).

If the free mapping is required, the PDO configuration check box must be checked and changed.

This screenshot is identical to the previous one, but the 'PDO Configuration' checkbox in the 'Download' section is now checked, indicating that free mapping is enabled.

4.6.1 Example: Free PDO Mapping

For the free mapping of the outputs the fixed mapping 0x1701 has to be switched off and one free mappable PDO 0x1600 can be used instead. The maximum number of bytes for each direction (inputs/outputs) is 64.

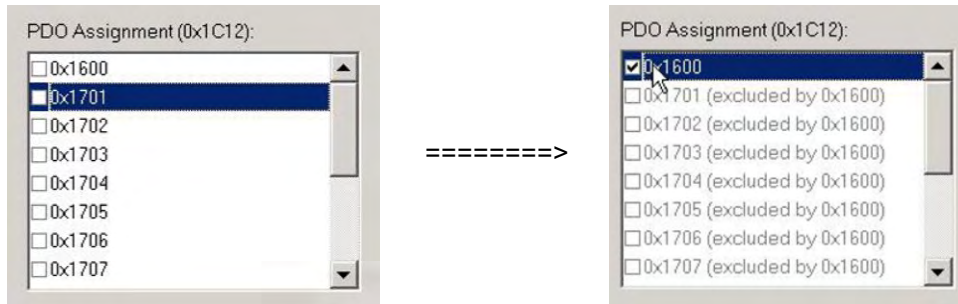

After that the default mapping of the PDO 0x1600 can be extended::

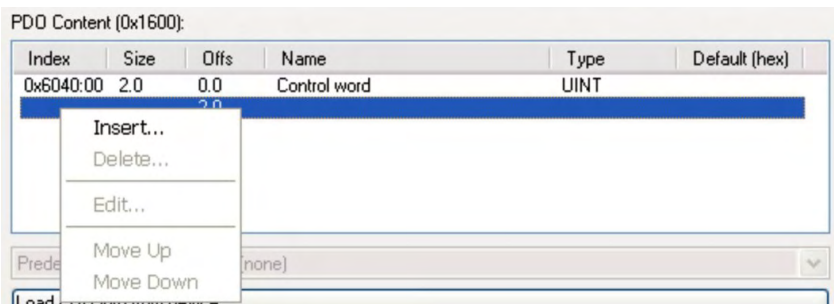

A list of possible objects for the mapping will be shown and a new entry can be chosen.

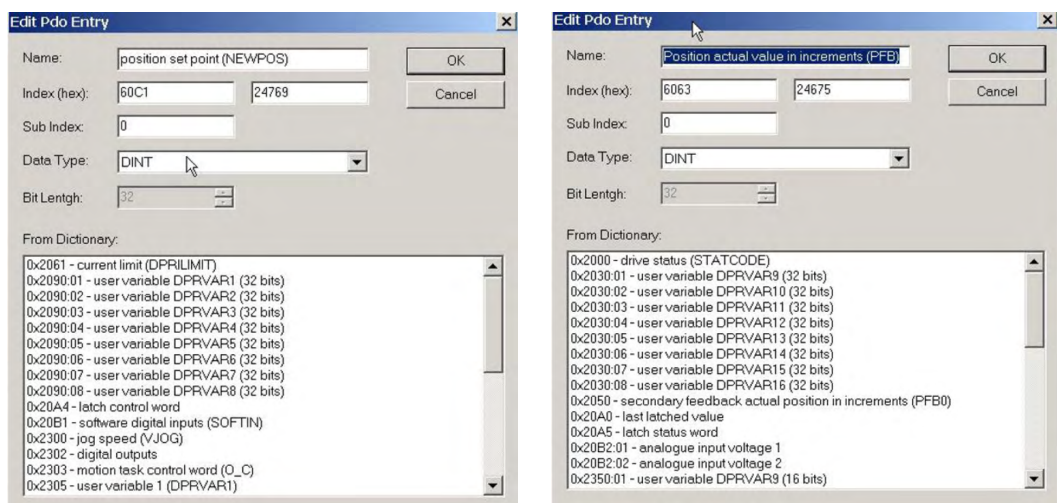

In this case the setpoint for the interpolated position mode is selected.

The same is valid for the Tx-PDO direction. Here the value of the actual internal position is selected.

This results in the startup SDO list for this sample free mapped configuration.

Transiti...	Protocol	Index	Data	Comment
<PS>	CoE	0x1C12:00	0x00 (0)	clear sm pdos (0x1C12)
<PS>	CoE	0x1C13:00	0x00 (0)	clear sm pdos (0x1C13)
<PS>	CoE	0x1A00:00	0x00 (0)	clear pdo 0x1A00 entries
<PS>	CoE	0x1A00:01	0x60410010 (1614872...	download pdo 0x1A00 entry
<PS>	CoE	0x1A00:02	0x60630020 (1617100...	download pdo 0x1A00 entry
<PS>	CoE	0x1A00:00	0x02 (2)	download pdo 0x1A00 entry count
<PS>	CoE	0x1600:00	0x00 (0)	clear pdo 0x1600 entries
<PS>	CoE	0x1600:01	0x60400010 (1614807...	download pdo 0x1600 entry
<PS>	CoE	0x1600:02	0x60C10020 (1623261...	download pdo 0x1600 entry
<PS>	CoE	0x1600:00	0x02 (2)	download pdo 0x1600 entry count
<PS>	CoE	0x1C12:01	0x1600 (5632)	download pdo 0x1C12:01 index
<PS>	CoE	0x1C12:00	0x01 (1)	download pdo 0x1C12 count
<PS>	CoE	0x1C13:01	0x1A00 (6656)	download pdo 0x1C13:01 index
<PS>	CoE	0x1C13:00	0x01 (1)	download pdo 0x1C13 count
PS	CoE	0x6060:00	0x01 (1)	Op mode
PS	CoE	0x60C2:01	0x02 (2)	Cycle time
PS	CoE	0x60C2:02	0xFD (253)	Cycle exp

If this shall be used in the NC, the interpolation set point position has to be linked from the axis to the NC axis.

The screenshot shows a tree view on the left with 'Axis 1' expanded to 'Axis 1_Drive' and 'Axis 1_Drive_Out'. The 'nOutData1' variable is selected. On the right, the 'Variable' configuration window is open, showing:

- Name: nOutData1
- Type: ARRAY [0..1] OF UINT
- Group: Outputs
- Size: 4.0
- Address: 168 (0x8)
- User ID: 0
- Linked to: (empty)
- Comment: (empty)
- ADS Info: Port: 501, IGp: 0xF030, IDffs: 0x8, Len: 4

The 'Attach Variable nOutData1 (Output)' dialog box is shown. The left pane shows the I/O Configuration tree with 'Data Record 1' selected under 'Drive 1'. The right pane contains the following options:

- Show Variables: Unused, Used and unused
- Exclude disabled
- Exclude other Devices
- Exclude same Image
- Show Tooltips
- Show Variable Types: Matching Type, Matching Size, All Types, Array Mode
- Offsets: Continuous, Show Dialog
- Variable Name: Hand over, Take over

Buttons: Cancel, OK

Linked to: Data Record 1 . Outputs . Drive 1 . Device 1 (EtherCAT) . I/O Device

Comment: (empty)

After doing this configuration the mapping can be activated as usual (see setup):

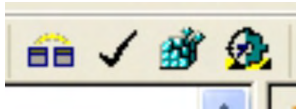

Now the NC-screen should show a position in the online window, which changes a bit in the last digits.

General		Settings	Parameter	Dynamics	Online	Functions	Coupling	Compensation
165.7124		Setpoint Position: [mm]		165.5651				
Lag Distance (min/max): [mm]		Actual Velocity: [mm/s]		Setpoint Velocity: [mm/s]				
0.0010 (-0.025, 0.002)		-0.0168		0.0000				
Override: [%]		Total / Control Output: [%]		Error:				
100.0000 %		0.00 / 0.00 %		0 (0x0)				
Status (log.)			Status (phys.)			Enabling		
<input type="checkbox"/> Ready <input type="checkbox"/> Calibrated <input type="checkbox"/> Has Job			<input checked="" type="checkbox"/> NOT Moving <input type="checkbox"/> Moving Fw <input type="checkbox"/> Moving Bw			<input type="checkbox"/> Coupled Mode <input type="checkbox"/> In Target Pos. <input type="checkbox"/> In Pos. Range		
						<input type="checkbox"/> Controller <input type="button" value="Set"/> <input type="checkbox"/> Feed Fw <input type="checkbox"/> Feed Bw		
Controller Kv-Factor: [mm/s/mm]		Reference Velocity: [mm/s]						
1		2200						
Target Position: [mm]		Target Velocity: [mm/s]						
0		0						
F1		F2		F3		F4		F5
								F6
								F8
								F9

After enabling the power stage with the All-button, the drive can be moved via the jog-buttons or via the functions in the function menu.

Set Enabling ✖

Controller
 Feed Fw
 Feed Bw

Override [%]:

+
F3

++
F4

4.7 Supported cyclical setpoint- and actual values

The following cycle segmentation applies to cyclical setpoint- and actual values that are not processed in the bus cycle or when the field bus is in IDLE.

S400/S600			S300/S700
Mapping 1-5	Mapping 6	Mapping 7-8	
2 ms cycle	1 ms cycle	4 ms cycle	250µs / 1ms

4.7.1 Supported cyclical setpoint values

Abbreviation "Sub" means "Subindex".

Name	CAN Object-number	Data type	Description
Current limit	0x2061 Sub 0	INT16	This can be used in all operating modes to limit the current actual value; the current limit value is processed in each EtherCAT bus cycle (ASCII: PTBASE); the current setpoint is given incrementally; 3280 increments correspond to the peak current for the device; the current limitation can be recorded with the DPRLIMIT macro variable.
DPRVAR1 (32 bits)	0x2090 Sub 1	INT32	Write access to macro variable DPRVAR1
DPRVAR2 (32 bits)	0x2090 Sub 2	INT32	Write access to macro variable DPRVAR2
DPRVAR3 (32 bits)	0x2090 Sub 3	INT32	Write access to macro variable DPRVAR3
DPRVAR4 (32 bits)	0x2090 Sub 4	INT32	Write access to macro variable DPRVAR4
DPRVAR5 (32 bits)	0x2090 Sub 5	INT32	Write access to macro variable DPRVAR5
DPRVAR6 (32 bits)	0x2090 Sub 6	INT32	Write access to macro variable DPRVAR6
DPRVAR7 (32 bits)	0x2090 Sub 7	INT32	Write access to macro variable DPRVAR7
DPRVAR8 (32 bits)	0x2090 Sub 8	INT32	Write access to macro variable DPRVAR8
Latch Controlword	0x20A4 Sub 0	UINT16	This object is used to activate the drive's latch status machine; the latch control word is processed independently of the EtherCAT bus cycle (ASCII: PTBASE).
Digital software inputs	0x20B1 Sub 0	INT32	Value for the digital software inputs (ASCII: SOFTIN)
Jog velocity	0x2300 Sub 0	INT32	Defines the velocity for the jog mode (ASCII: VJOG)
State of digital output	0x2302 Sub 0	INT16	Defines states of the digital output 1 and 2 Bit0 = output 1, Bit1 = output 2
Motion task control word	0x2303 Sub 0	INT32	Defines the control word for the actual motion task (ASCII: O_C)
DPRVAR1 (lower 16 bits)	0x2305 Sub 0	INT16	Write access to the lower 16 bits of the macro variable DPRVAR1
DPRVAR2 (lower 16 bits)	0x2306 Sub 0	INT16	Write access to the lower 16 bits of the macro variable DPRVAR2
additive current setpoint	0x2307 Sub 0	INT16	This can be used in positioning and speed control operating modes for pilot current control; the additive current setpoint is processed in each EtherCAT bus cycle (ASCII: PTBASE); the current setpoint is given incrementally; 3280 increments correspond to the peak current for the device; the additive current setpoint can be recorded with the IVORCMD macro variable.
Additive velocity setpoint (velocity feed forward)	0x2308	INT32	Can be used in positioning operating modes. Usually the additive velocity setpoint is calculated automatically according to the position setpoint change. When bit 0x20 in parameter FFTSW is set to 1 the automatically calculation is switched off and the additive velocity setpoint can be commanded by EtherCAT. The velocity feed forward is given incrementally; $2^{32}/(60 \cdot 4000) = 17896$ increments corresponds to 1 RPM. The received value is multiplied with the feed-forward gain GPFV . The additive velocity setpoint can be recorded with the macro variable VVORCMD (received value) or with VSETFF (value multiplied with GPFV).
Motion task velocity override	0x2310 Sub 0	INT16	Defines the digital override value (ASCII: DOVERRIDE)

Name	CAN Object-number	Data type	Description
Opmode request	0x2352 Sub 0	UINT16	This object is used to set the drive's operating mode (ASCII: OPMODE); the operating mode request is processed independently of the EtherCAT bus cycle
ASCII input data	0x2355	INT32	Contains up to 4 bytes of ASCII data. In conjunction with bit 0x8000 of control word (toggle-bit) these data bytes are transferred to the ASCII command interpreter and processed in the background task (similar to the processing of the serial port ASCII data). Not valid bytes should be set to 0.
Controlword	0x6040 Sub 0	UINT16	This object is used to activate the drive's status machine; the control word is processed independently of the EtherCAT bus cycle when the field bus is in IDLE.
Current setpoint	0x6071 Sub 0	INT16	Used in cyclical synchronous torque interface mode (ASCII: OPMODE 2); The current setpoint is processed in each EtherCAT bus cycle (ASCII: PTBASE); the current setpoint is given incrementally; a unit of 3280 increments corresponds to the peak current for the device; the current setpoint can be recorded with the ICMD macro variable.
Motion task target position	0x607A Sub 0	INT32	Defines the target position for the actual motion task (ASCII: O_P)
Motion task target velocity	0x6081 Sub 0	INT32	Defines the target velocity for the actual motion task (ASCII: O_V)
Motion task acceleration	0x6083 Sub 0	INT32	Defines the acceleration value for the actual motion task (ASCII: O_ACC)
Motion task deceleration	0x6084 Sub 0	INT32	Defines the acceleration value for the actual motion task (ASCII: O_DEC)
Motion task profile number	0x6086 Sub 0	INT32	Defines the profile number for table motion task (ASCII: O_TAB)
Position setpoint	0x60C1 Sub 0	INT32	This is used in cyclical synchronous position interface mode (ASCII: OPMODE 5) with a linear or quadratic interpolation (only /) in 250 µs steps; the position setpoint is processed in each EtherCAT bus cycle (ASCII: PTBASE); the position setpoint is given in increments per motor revolution, whereby bit resolution can be set with the ASCII PRBASE parameter; the position setpoint can be recorded with the NEWPOS macro variable.
Velocity setpoint	0x60FF Sub 0	INT32	This is used in cyclical synchronous speed interface mode (ASCII: OPMODE 0); The speed setpoint is processed in each EtherCAT bus cycle (ASCII: PTBASE); the speed setpoint is given incrementally. (1 RPM = $2^{32}/(128 \cdot 4000 \cdot 60) = 139,81$ counts); the speed setpoint can be recorded with the VCMD macro variable.

4.7.2 Supported cyclical actual values

Abbreviation "Sub" means "Subindex".

Name	CAN Object-number	Data type	Description
Motion task status value	0x1002 Sub 0	INT32	Status value for the motion task functionality (ASCII: TRJSTAT)
Drive errors	0x1003 Sub 0	INT32	Active drive errors (ASCII: ERRCODE)
Drive warnings	0x2000 Sub 0	INT32	Active drive warnings (ASCII: STATCODE)
DPRVAR9	0x2030 Sub 1	INT32	Actual value of macro variable DPRVAR9
DPRVAR10	0x2030 Sub 2	INT32	Actual value of macro variable DPRVAR10
DPRVAR11	0x2030 Sub 3	INT32	Actual value of macro variable DPRVAR11
DPRVAR12	0x2030 Sub 4	INT32	Actual value of macro variable DPRVAR12
DPRVAR13	0x2030 Sub 5	INT32	Actual value of macro variable DPRVAR13
DPRVAR14	0x2030 Sub 6	INT32	Actual value of macro variable DPRVAR14
DPRVAR15	0x2030 Sub 7	INT32	Actual value of macro variable DPRVAR15
DPRVAR16	0x2030 Sub 8	INT32	Actual value of macro variable DPRVAR16
Position actual value 2	0x2050	INT32	This object is used to return position value 2 of a second, external encoder; the actual position value is processed in each EtherCAT bus cycle (ASCII: PTBASE); the actual position value is returned in increments per motor revolution, whereby the bit resolution can be set with the ASCII PRBASE parameter; actual position value 2 can be recorded with the PFB0 MACRO variable
ENDAT 2.2 diagnose information	0x2054 Sub 1..16	INT16	This contains up to 16 ENDAT2.2-encoder diagnose information. Diagnose data has to be supported by the encoder and by the firmware (5.91 and newer) and configured in the drive (s. ASCII commands EN22CNFG and EN22DCNT . The meaning of the transmitted value can be found in the ENDAT documentation.
ENDAT 2.2 additional information 1	0x2055 Sub 1..16	INT16	This contains up to 16 ENDAT2.2-encoder additional information 1 (AI1). This data has to be supported by the encoder and by the firmware (5.91 and newer) and configured in the drive (s. ASCII commands EN22CNFG and EN22A1CNT . The meaning of the transmitted value can be found in the ENDAT documentation.
ENDAT 2.2 additional information 2	0x2056 Sub 1..16	INT16	This contains up to 16 ENDAT2.2-encoder additional information 2 (AI2). This data has to be supported by the encoder and by the firmware (5.91 and newer) and configured in the drive (s. ASCII commands EN22CNFG and EN22A2CNT . The meaning of the transmitted value can be found in the ENDAT documentation.
Latch Position	0x20A0	INT32	This object is used to return the drive's actual latched position. The value provided (positive/negative edge, latch 1/2) is determined by the latch control word.
Latch Status word	0x20A5	UINT16	This object is used to return the drive's latch status; see also the description of the latch control and latch status words.
Analog input 1	0x20B2 Sub 1	INT16	Actual value of analog input 1 (in mV, ASCII: ANIN1)
Analog input 2	0x20B2 Sub 2	INT16	Actual value of analog input 2 (in mV, ASCII: ANIN2)
DPRVAR9 (lower 16 bits)	0x2350 Sub 1	INT16	Actual value of the lower 16 bits of macro variable DPRVAR9
DPRVAR10 (lower 16 bits)	0x2350 Sub 2	INT16	Actual value of the lower 16 bits of macro variable DPRVAR10
DPRVAR11 (lower 16 bits)	0x2350 Sub 3	INT16	Actual value of the lower 16 bits of macro variable DPRVAR11
DPRVAR12 (lower 16 bits)	0x2350 Sub 4	INT16	Actual value of the lower 16 bits of macro variable DPRVAR12
DPRVAR13 (lower 16 bits)	0x2350 Sub 5	INT16	Actual value of the lower 16 bits of macro variable DPRVAR13
DPRVAR14 (lower 16 bits)	0x2350 Sub 6	INT16	Actual value of the lower 16 bits of macro variable DPRVAR14
DPRVAR15 (lower 16 bits)	0x2350 Sub 7	INT16	Actual value of the lower 16 bits of macro variable DPRVAR15
DPRVAR16 (lower 16 bits)	0x2350 Sub 8	INT16	Actual value of the lower 16 bits of macro variable DPRVAR16
State of software outputs	0x2351 Sub 0	INT32	Actual value of the digital software outputs (ASCII: SOFTOUT)

Name	CAN Object-number	Data type	Description
Message: Operation modes	0x2353	INT16	This object is used to return the drive's operating mode (ASCII: OPMODE); the operating mode request is processed independently of the EtherCAT bus cycle (ASCII: PTBASE).
ASCII output data	0x2355	INT32	This contains up to 4 bytes of ASCII data generated by the ASCII command interpreter as answer for the ASCII input data (object 0x2355). These data are processed in the background task (similar to the processing of the serial port ASCII data). Not valid bytes are set to 0.
Actual current value	0x3570 Sub 0	INT32	Actual current value of the motor in mA (ASCII: I).
Actual Motor temperature	0x3612	INT16	Actual motor temperature in configured units (ASCII: TEMPM)
Actual velocity value	0x3618 Sub 0	INT32	Actual velocity value of the motor in SI units (ASCII: V).
Actual bus voltage value	0x361A Sub 0	INT16	Actual value of the DC Bus in volt (ASCII: VBUS)
Status word	0x6041	UINT16	This object is used to return the drive's status; the status word is processed independently of the EtherCAT bus cycle when the field bus is in IDLE.
Actual position setpoint	0x6062 Sub 0 0x60FC Sub 0	INT32	Actual position set point in internal units. The position setpoint is given in increments per motor revolution, whereby bit resolution can be set with the ASCII PRBASE parameter 1 revolution = 2^{PRBASE} increments. The position setpoint can be recorded with the S_SET MACRO variable.
Position actual value 1	0x6063	INT32	This object is used to return position value 1 of the motor encoder; if a second, external encoder is set up for positioning control, external actual position value 2 is returned in actual position value 1; the actual position value is processed in each EtherCAT bus cycle (ASCII: PTBASE); the actual position value is returned in increments per motor revolution, whereby the bit resolution can be set with the PRBASE parameter; actual position value 1 can be recorded with the PFB MACRO variable.
Actual position value	0x6064 Sub 0	INT32	Actual position of the motor feedback in SI units (ASCII: PFB)
Actual velocity (counts)	0x606C Sub 0	INT32	Actual motor velocity in counts (1 RPM = $2^{32}/(128*4000*60) = 139.81$ counts)
Current actual value	0x6077	INT16	This object is used to return the current actual value; the current actual value is processed in each EtherCAT bus cycle (ASCII: PTBASE); the current actual value is given incrementally; a unit of 3280 increments corresponds to the peak current for the device; the current actual value can be recorded with the I MACRO variable
Internal following error	0x60F4	INT32	This object is used to return the internal drive tracking error; the tracking error is processed in each EtherCAT bus cycle (ASCII: PTBASE); the tracking error is returned in increments per motor revolution, whereby the bit resolution can be set with the ASCII PRBASE parameter; the tracking error can be recorded with the PE MACRO variable.
Digital I/O	0x60FD Sub 0	INT16	State of the digital inputs/outputs Bit 0 – digital output 2 Bit 1 – digital output 1 Bit 2 – hardware enable Bit 3 – digital input 4 Bit 4 – digital input 3 Bit 5 – digital input 2 Bit 6 – digital input 1 Bit 7 – digital input 5 (S700 only) Bit 8 – digital input 6 (S700 only)

4.8 Supported operation modes

The following values are used for selection and feedback operating modes:

- cyclic synchronous position mode 0x08 und 0xFA
- cyclic synchronous velocity mode 0x09 und 0xFE
- cyclic synchronous torque mode 0x0A und 0xFD
- homing mode 0x06 und 0xF9

Negative values correspond to manufacturer-specific settings in 6060.

4.9 Adjusting the EtherCAT cycle time

The cycle time to be used in the servo amplifier for the cyclical setpoints and actual values can either be stored in the [PTBASE](#) parameter in the amplifier or configured in the startup phase.

This takes place via SDO mailbox access (→ # 33) to CANopen objects 60C2 subindex 1 & 2. Subindex 2, known as the interpolation time index, defines the power of ten of the time value (e.g. -3 means 10⁻³ or milliseconds) while subindex 1, known as interpolation time units, gives the number of units (e.g. 4 means 4 units).

If you wish to run a 2 ms cycle, this can be achieved by means of various combinations. For example,

Index = -3, Units = 2 or

Index = -4, Units = 20 etc.

The [PTBASE](#) parameter is counted in increments of 250 microseconds within the device. This means, for example, that 2 ms equates to a [PTBASE](#) of 8.

4.10 Recommended cycle times depending on mode of operation

The minimum cycle time for the servo amplifier is largely dependent on the drive configuration (second actual position value encoder, latches). As far as possible, the drive's analog evaluations should be deactivated ([ANOUT1](#)=0, [ANOUT2](#)=0, [ANCNFG](#)= -1).

Interface	Cycle time S400/S600	Cycle time S300/S700
Position	≥ 1 ms (≥ 1000 μs)	≥ 0.25 ms (≥ 250 μs)
Velocity	≥ 0.50 ms (≥ 500 μs)	≥ 0.25 ms (≥ 250 μs)
Torque	≥ 0.25 ms (≥ 250 μs)	≥ 0.25 ms (≥ 250 μs)

4.11 Synchronization based on cycle time

On all Kollmorgen servo amplifiers, the internal PLL is able to even out an average deviation of up to 1000 ppm in the cycle time provided by the master. By way of an example, if the cycle time is set to 1 ms, the drive will still be able to synchronize with an average deviation of up to +/- 1 μs in the cycle time from the master by using its internal PLL. Average deviation in the cycle time refers to the average length of all cycles.

Depending on the cycle time set, the servo amplifier will allow the following levels of jitter in the master cycle time without reporting a synchronization fault.

Cycle time ≥ 1 ms → permissible jitter = 320 μs

Cycle time ≤ 750 μs → permissible jitter = 70 μs

On the second consecutive master interrupt beyond the allowed jitter level, the drive reports a F28 synchronization error, or warning n17. Synchronization monitoring can be switched off via the [SERCSET](#) ASCII command, bits 17 and 18.

4.12 Latch controlword and Latch statusword

Latch Controlword (2 Byte)

Bit	Value (bin)	Value (hex)	Description
0	00000000 00000001	xx01	Enable external latch 1 (positive rise)
1	00000000 00000010	xx02	Enable external latch 1 (negative rise)
2	00000000 00000100	xx04	Enable external latch 2 (positive rise)
3	00000000 00001000	xx08	Enable external latch 2 (negative rise)
4	00000000 00010000	xx10	Enable internal latch C (positive rise)
5-7			Reserve
8-12	00000001 00000000	01xx	Read external latch 1 (positive rise)
	00000010 00000000	02xx	Read external latch 1 (negative rise)
	00000011 00000000	03xx	Read external latch 2 (positive rise)
	00000100 00000000	04xx	Read external latch 2 (negative rise)
	00000101 00000000	05xx	Read external latch C (positive rise)
13-15			Reserve

Latch Statusword (2 Byte)

Bit	Value (bin)	Value (hex)	Description
0	00000000 00000001	xx01	External latch 1 valid (positive rise)
1	00000000 00000010	xx02	External latch 1 valid (negative rise)
2	00000000 00000100	xx04	External latch 2 valid (positive rise)
3	00000000 00001000	xx08	External latch 2 valid (negative rise)
4	00000000 00010000	xx10	Internal latch C valid (positive rise)
5-7			Reserve
8-11	00000001 00000000	X1xx	Acknowledge value external latch 1 (positive rise)
	00000010 00000000	X2xx	Acknowledge value external latch 1 (negative rise)
	00000011 00000000	X3xx	Acknowledge value external latch 2 (positive rise)
	00000100 00000000	X4xx	Acknowledge value external latch 2 (negative rise)
	00000101 00000000	x5xx	Acknowledge value internal latch C (positive rise)
12-15	00010000 00000000	1xxx	Status Digital Input 4
	00100000 00000000	2xxx	Status Digital Input 3
	01000000 00000000	4xxx	Status Digital Input 2
	10000000 00000000	8xxx	Status Digital Input 1

4.13 Mailbox Handling

With EtherCAT, acyclical data traffic (object channel or SDO channel) is called mailbox. This system is based around the master:

Mailbox Output:	The master (EtherCAT controller) sends data to the slave (servo amplifier). This is essentially a (read/write) request from the master. Mailbox output operates via Sync Manager 0.
Mailbox Input:	The slave (servo amplifier) sends data to the master (EtherCAT controller). The master reads the slave's response. Mailbox input operates via Sync Manager 1.

The timing diagram illustrates the mailbox access process:



1)	The EtherCAT master writes the mailbox request to the mail-out buffer.
2)	On the next interrupt, the EtherCAT interface activates a Sync Manager 0 event (mailbox output event) in the AL event register.
3)	The servo amplifier reads 16 bytes from the mail-out buffer and copies them to the internal mailbox output array.
4)	The servo amplifier identifies new data in the internal mailbox output array and performs an SDO access to the object requested by the EtherCAT interface. The response from the servo amplifier is written to an internal mailbox input array.
5)	The servo amplifier deletes all data in the internal mailbox output array so that a new mailbox access attempt can be made.
6)	The servo amplifier copies the response telegram from the internal mailbox input array to the mail-in buffer of the EtherCAT interface.

4.13.1 Mailbox Output

An interrupt by the EtherCAT-interface with a Sync Manager 0 - Event starts a Mailbox Output Process. A 1 in the Mail Out Event-Bit of the AL Event register signalizes the servo amplifier, that the EtherCAT-interface wants to send a Mailbox message and that it has already stored the required data in the Mail Out Buffer. Now 16 Byte data are read by the servo amplifier with the IRQ process.

The bytes are defined as follows:

Address 0x1800								Address 0x180F							
0	1	2	3	4	5	6	7	8	9	10	11	12	13	14	15
CAN over EtherCAT specific data (CoE Header)								CAN specific data (standard CAN SDO)							

Byte 0	Length of the data (Low Byte)
Byte 1	Length of the data (High Byte)
Byte 2	Address (Low Byte)
Byte 3	Address (High Byte)
Byte 4	Bit 0...5: Channel Bit 6...7: Priority
Byte 5	Bit 0...3: Type <ul style="list-style-type: none"> ● 1 = Reserved: ADS over EtherCAT ● 2 = Reserved: Ethernet over EtherCAT ● 3 = Can over EtherCAT... Bit 4...7: Reserved
Byte 6	PDO Number (with PDO transmissions only, Bit 0 = LSB of the PDO number, see Byte 7 for MSB)
Byte 7	Bit 0: MSB of the PDO number, see Byte 6) Bit 1...3: Reserved Bit 4...7: CoE specific type <ul style="list-style-type: none"> 0: Reserved ● 1: Emergency message ● 2: SDO request ● 3: SDO answer ● 4: TxPDO ● 5: RxPDO ● 6: Remote transmission request of a TxPDO ● 7: Remote transmission request of a RxPDO ● 8...15: reserved
Byte 8	Control-Byte in the CAN telegram: write access:0x23=4Byte, 0x27=3Byte, 0x2B=2Byte, 0x2F=1Byte read access:0x40
Byte 9	Low Byte of the CAN object number (Index)
Byte 10	High Byte of the CAN object number (Index)
Byte 11	Subindex according to CANopen Specification for the servo amplifier
Byte 12	Data with a write access (Low Byte)
Byte 13	Data with a write access
Byte 14	Data with a write access
Byte 15	Data with a write access (High Byte)

The servo amplifier answers to ever telegram with an answer in the Mailbox Input buffer.

4.13.2 Mail Input

The servo amplifier answers to every CoE telegram with a 16 Byte answer telegram in the Mailbox Input buffer. The bytes are defined as follows:

Address 0x1C00								Address 0x1C0F							
0	1	2	3	4	5	6	7	8	9	10	11	12	13	14	15
CAN over EtherCAT specific data (CoE Header)								CAN specific data (standard CAN SDO)							

Byte 0	Length of the data (Low Byte)
Byte 1	Length of the data (High Byte)
Byte 2	Address (Low Byte)
Byte 3	Address (High Byte)
Byte 4	Bit 0...5: Channel Bit 6...7: Priority
Byte 5	Bit 0...3: Type <ul style="list-style-type: none"> • 1 = Reserved: ADS over EtherCAT • 2 = Reserved: Ethernet over EtherCAT • 3 = Can over EtherCAT... Bit 4...7: Reserved
Byte 6	PDO Number (with PDO transmissions only, Bit 0 = LSB of the PDO number, see Byte 7 for MSB)
Byte 7	Bit 0: MSB of the PDO number, see Byte 6) Bit 1...3: Reserved Bit 4...7: CoE specific type <ul style="list-style-type: none"> • 0: Reserved • 1: Emergency message • 2: SDO request • 3: SDO answer • 4: TXPDO • 5: RxPDO • 6: Remote transmission request of a TxPDO • 7: Remote transmission request of a RxPDO • 8...15: reserved
Byte 8	Control-Byte in the CAN telegram: write access: OK: 0x60 read access: OK + length: 0x43 (4 Byte), 0x47 (3 Byte), 0x4B (2Byte), 0x4F (1Byte) - error with read- or write access: 0x80
Byte 9	Low Byte of the CAN object number (Index)
Byte 10	High Byte of the CAN object number (Index)
Byte 11	Subindex according to CANopen Specification for the servo amplifier
Byte 12	Data (Low Byte)
Byte 13	Data
Byte 14	Data
Byte 15	Data (High Byte)

- Error code according to CANopen Specification in case of an error
- Data value of the object in case of successful read access

4.13.3 Example: Mailbox access

In the example below PDOs 0x1704 are mapped. (see Chapter 'Fixed PDO Mappings' (→ # 21)).
The master sends this Mailbox-Output message:

Byte 0	0x0A	The next 10 Bytes contain data (Byte 2 ... Byte 11)
Byte 1	0x00	The next 10 Bytes contain data (Byte 2 ... Byte 11)
Byte 2	0x00	Address 0
Byte 3	0x00	Address 0
Byte 4	0x00	Channel 0 and Priority 0
Byte 5	0x03	CoE Object
Byte 6	0x00	PDO Number 0
Byte 7	0x20	PDO Number 0 and SDO-Request
Byte 8	0x2B	2 Byte write access
Byte 9	0x12	SDO-Object 0x1C12
Byte 10	0x1C	SDO-Object 0x1C12
Byte 11	0x01	Subindex 1
Byte 12	0x04	Data value 0x00001704
Byte 13	0x17	Data value 0x00001704
Byte 14	0x00	Data value 0x00001704
Byte 15	0x00	Data value 0x00001704

The answer of the servo amplifier must be:

Byte 0	0x0E	The next 14 Bytes contain data (Byte 2 ... Byte 15)
Byte 1	0x00	The next 14 Bytes contain data (Byte 2 ... Byte 15)
Byte 2	0x00	Address 0
Byte 3	0x00	Address 0
Byte 4	0x00	Channel 0 and Priority 0
Byte 5	0x03	CoE Object
Byte 6	0x00	PDO Number 0
Byte 7	0x20	PDO Number 0 and SDO-Answer
Byte 8	0x60	Successful write access
Byte 9	0x12	SDO-Object 0x1C12
Byte 10	0x1C	SDO-Object 0x1C12
Byte 11	0x01	Subindex 1
Byte 12	0x00	Data value 0x00000000
Byte 13	0x00	Data value 0x00000000
Byte 14	0x00	Data value 0x00000000
Byte 15	0x00	Data value 0x00000000

5 Index

A

Abbreviations	7
AL Control	16
AL Event	15
AL Status	16
AL Status Code	16
Assembly	8

C

CoE	18
Communication phases	17
Control word	19
Cycle time	
Adjustment	31
Recommendation	31
Cyclical actual values	29
Cyclical setpoint values	27

E

EtherCAT Setup	11
Expansion card	9

I

Installation	8
Interrupt Enable	15
Interrupt Event	15

L

Latch controlword	32
Latch statusword	32
LEDs	9

M

Mailbox	33
---------------	----

O

Operation modes	31
-----------------------	----

P

PDO Mapping	
Fixed PDO Mapping	21
Free PDO Mapping	23
Phase run-up	16

S

Setup	10
Setup Software	10
Slave Register	14
Status machine	18, 20
Symbols used	6
Synchronization	31

T

Target group	5
--------------------	---

U

Use as directed	6
-----------------------	---

Service

We are committed to quality customer service. In order to serve in the most effective way, please contact your local sales representative for assistance.

If you are unaware of your local sales representative, please contact the Customer Support.



Join the [Kollmorgen Developer Network](#) for product support. Ask the community questions, search the knowledge base for answers, get downloads, and suggest improvements.



Europe

KOLLMORGEN

Internet: www.kollmorgen.com/en-us

E-Mail: technik@kollmorgen.com

Tel.: +49 - 2102 - 9394 - 0

Fax: +49 - 2102 - 9394 - 3155



North America

KOLLMORGEN

Internet: www.kollmorgen.com/en-us

E-Mail: support@kollmorgen.com

Tel.: +1 - 540 - 633 - 3545

Fax: +1 - 540 - 639 - 4162



South America

KOLLMORGEN

Internet: www.kollmorgen.com/pt-br

E-Mail: contato@kollmorgen.com

Tel.: +55 - 11 - 4615-6300



Asia

KOLLMORGEN

Internet: www.kollmorgen.cn

E-Mail: sales.china@kollmorgen.com

Tel: +86 - 400 668 2802

Fax: +86 - 21 6248 5367

